

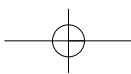

ARTHROSCOPY

HADEO
INSTRUMENTE GERMANY

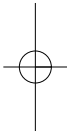

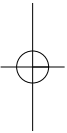
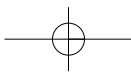

Endoskope für Arthroskopie
 Endoscopes for Arthroscopy
 Endoscopios para artroscopía
 Ottiche endoscopiche per artroscopia

Ø 4 mm

Arthroskop, autoklavierbar mit integrierter Faser zur Beleuchtung für diagnostische und operative Eingriffe, Ø 4 mm, Arbeitslänge 175 mm:
 Knie, Perkutane Nukleotomie, lumbaler Bandscheibenvorfall, für Schulter-Arthroskopie.

Arthroscope, autoclavable, with integrated fiber optic for illumination, for diagnostic and operation, Ø 4 mm, working length 175 mm:
 Knee, percutaneous nucleotomy, shoulder arthroscopy.

Artroscopios (ópticas) autoclavables con fibraoptica incorporado para intervenciones diagnósticas y operativas, diámetro de 4 mm, largo útil 175 mm:
 rodilla, nucleotomía percutánea, hernias lumbales y artroscopía de la espalda y hombro.

Ottiche autoclavabili con fibre ottiche per interventi diagnostici e operativi, Ø 4 mm Lunghezza operativa 175 mm:
 Ginocchio, nucleotomia percutanea, ernia lombare, artroscopia della spalla.

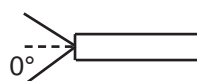
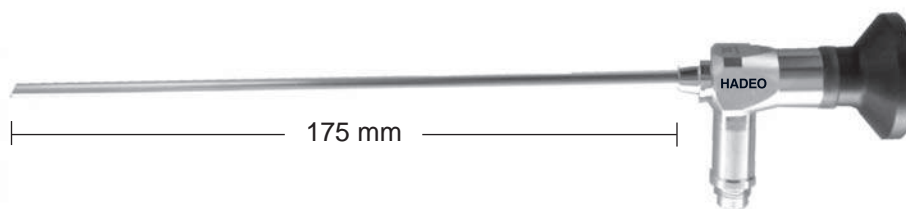

Geradeausblick
 Direct vision
 Vision directa
 Visione diretta angolo di

R400-040175-000

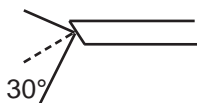

Vorausblick
 Foroblique vision
 ángulo de
 Visione grandangolo, angolo di

R400-040175-030

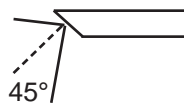

Vorausblick
 Foroblique vision
 ángulo de
 Visione grandangolo, angolo di

R400-040175-045



Seitblick
 Lateral vision
 ángulo de
 Visione laterale, angolo di

R400-040175-070

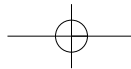

Trokarhülsen für Endoskope mit Ø 4 mm
Trocar sleeves for endoscopes with Ø 4 mm
Tubos para endoscopios de Ø 4 mm
Camicie per artroscopia, ottiche di Ø 4 mm

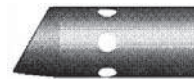
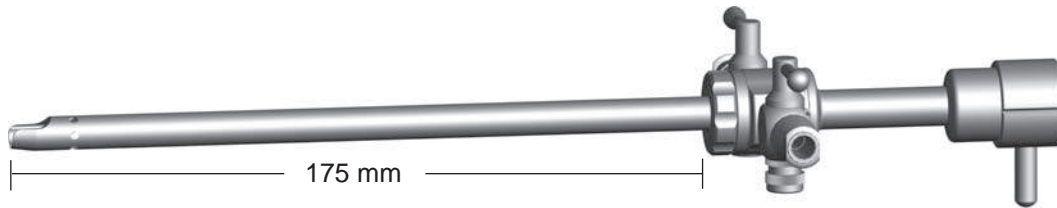

30°

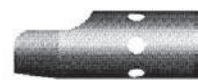

universal

Trokar-Hülse mit zwei Spülhähnen, drehbar, 4 mm Ø
Trocar sleeve, with two stop cocks rotating, 4 mm Ø
Tubo con dos llaves giratorias, de 4 mm Ø
Camicia per trocar, con due rubinetti d'irrigazione rotativi, 4 mm Ø

R414-040175-030

R414-040175-070

ein Spülhahn fest / one stop cock fixed
una llave fija / un rubinetto d'irrigazione fisso

R411-040175-030

R411-040175-070

zwei Spülhähne fest / two stop cocks fixed
dos llaves fijas / 2 rubinetti d'irrigazione fissi

R412-040175-030

R412-040175-070

mit einem Spülhahn drehbar / with one stop cock rotating
con una llave giratoria / con un rubinetto d'irrigazione rotativo

R413-040175-030

R413-040175-070

Obturator 4 mm Ø
Obturator 4 mm Ø
Obturador de 4 mm Ø
Otturatore 4 mm Ø



scharf / sharp / agudo / punta trequarti

R410-040175-001



konisch stumpf / conical blunt / cónico romo / punta conica smussa

R410-040175-002



stumpf / blunt / romo / punta cilindrica smussa

R410-040175-003

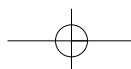

Endoskope für Arthroskopie
 Endoscopes for Arthroscopy
 Endoscopios para artroscopía
 Ottiche per artroscopia

Ø 2,7 mm

Arthroskop, autoklavierbar mit integrierter Faser zur Beleuchtung für diagnostische und operative Eingriffe,
 Ø 2,7 mm, Arbeitslänge 110 mm:
 Kleine Gelenke und Karpaltunnel

Arthroscope, autoclavable, with integrated fiber optic for illumination, for diagnostic and operation,
 Ø 2.7 mm, working length 110 mm:
 small joints and carpal tunnel

Artroscopios (ópticas) autoclavables con fibroptica incorporado para intervenciones diagnósticas y operativas,
 diámetro de 2,7 mm, largo útil 110 mm:
 articulaciones pequeñas

Ottiche autoclavabili con fibre ottiche per interventi diagnostici e operativi,
 Ø 2,7 mm Lunghezza operativa 110 mm:
 Piccole articolazioni e tunnel carpale

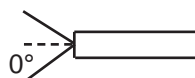
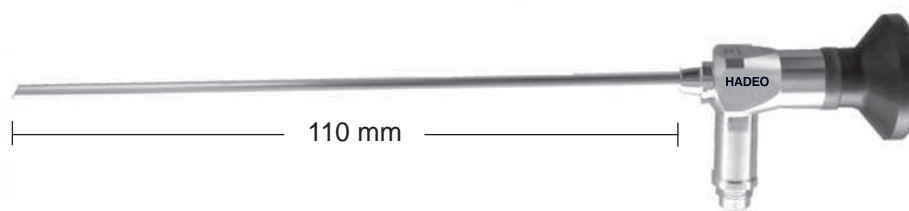

Geradeausblick
 Direct vision
 Vision directa
 Visione diretta angolo di

R400-027110-000

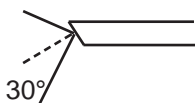

Vorausblick
 Foroblique vision
 ángulo de
 Visione grandangolo, angolo di

R400-027110-030



Seitblick
 Lateral vision
 ángulo de
 Visione laterale angolo di

R400-270110-070

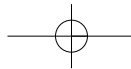

Trokarhülsen für Endoskope mit Ø 2,7 mm
Trocar sleeves for endoscopes with Ø 2.7 mm
Tubos para endoscopios de Ø 2,7 mm
Camicie per artroscopia, ottiche di Ø 2,7 mm

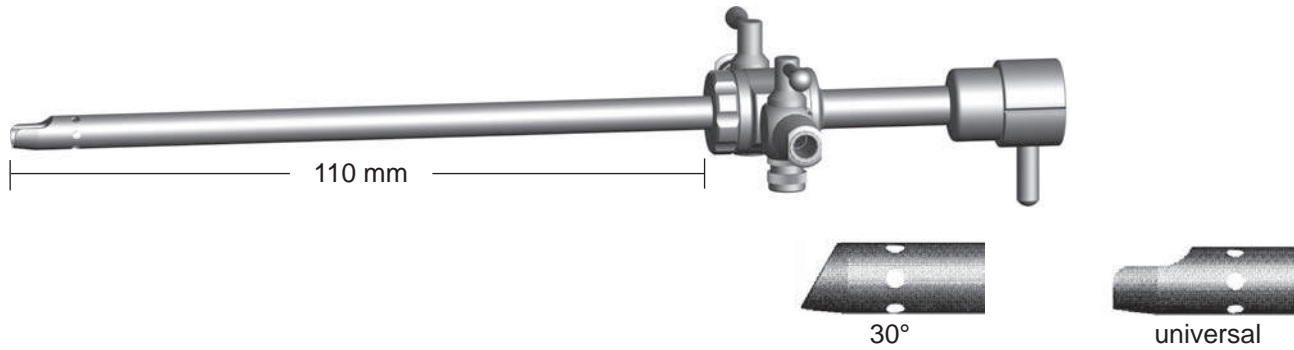

Trokar-Hülse mit zwei Spülhähnen, drehbar, 2,7 mm Ø
Trocar sleeve, with two stop cocks rotating, 2.7 mm Ø
Tubo con dos llaves giratorias, de 2,7 mm Ø
Camicia per trocar, con due rubinetti d'irrigazione rotativi, 2,7 mm Ø

R414-027110-030

R414-027110-070

mit einem Spülhahn drehbar
with one stop cock rotating
con una llave giratoria
con un rubinetto d'irrigazione rotativo

R413-027110-030

R413-027110-070

Obturator 2,7 mm Ø
Obturator 2.7 mm Ø
Obturador de 2,7 mm Ø
Otturatore 2,7 mm Ø



scharf / sharp / agudo / punta trequarti

R410-027110-001



konisch stumpf / conical blunt / cónico romo / punta conica smussa

R410-027110-002



stumpf / blunt / romo / punta cilindrica smussa

R410-027110-003

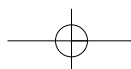

Endoskope für Arthroskopie
 Endoscopes for Arthroscopy
 Endoscopios para artroscopía
 Ottiche per artroscopia

Ø 2,7 mm

Arthroskop, autoklavierbar mit integrierter Faser zur Beleuchtung für diagnostische und operative Eingriffe,
 Ø 2,7 mm, Arbeitslänge 175 mm:
 Kleine Gelenke

Arthroscope, autoclavable, with integrated fiber optic for illumination, for diagnostic and operation,
 Ø 2.7 mm, working length 175 mm:
 small joint

Artroscopios (ópticas) autoclavables con fibroptica incorporado para intervenciones diagnósticas y operativas,
 diámetro de 2,7 mm, largo útil 175 mm:
 articulaciones pequeñas

Ottiche autoclavabili con fibre ottiche per interventi diagnostici e operativi,
 Ø 2,7 mm Lunghezza operativa 175 mm:
 Piccole articolazioni

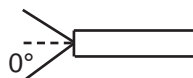
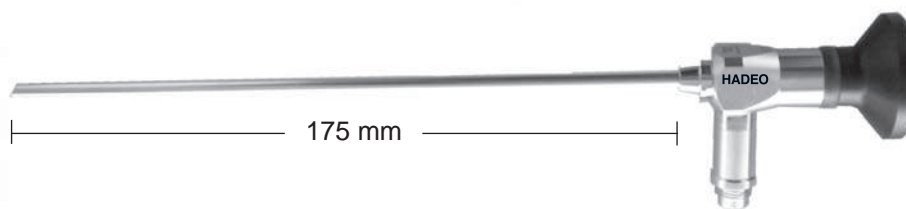

Geradeausblick
 Direct vision
 Vision directa
 Visione diretta angolo di

R400-027175-000

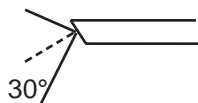

Vorausblick
 Foroblique vision
 ángulo de
 Visione grandangolo, angolo di

R400-027175-030

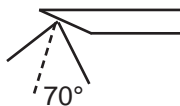

Seitblick
 Lateral vision
 ángulo de
 Visione laterale angolo di

R400-027175-070

Trokarhülsen für Endoskope mit Ø 2,7 mm
 Trocar sleeves for endoscopes with Ø 2.7 mm
 Tubos para endoscopios de Ø 2,7 mm
 Camicie per artroscopia, ottiche di Ø 2,7 mm

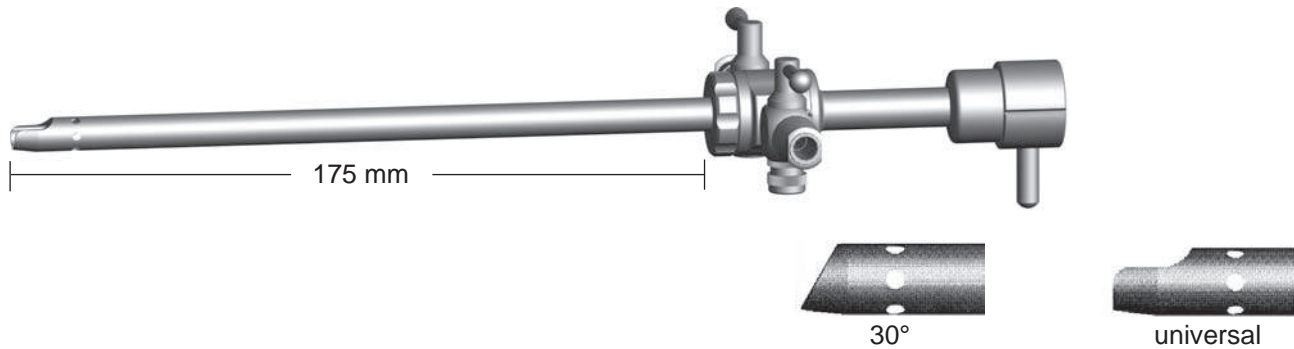

Trokar-Hülse mit zwei Spülhähnen, drehbar, 2,7 mm Ø
 Trocar sleeve, with two stop cocks rotating, 2.7mm Ø
 Tubo con dos llaves giratorias, de 2,7 mm Ø
 Camicia per trocar, con due rubinetti d'irrigazione rotativi, 2,7 mm Ø

R414-027175-030

R414-027175-070

mit einem Spülhahn drehbar
 with one stop cock rotating
 con una llave giratoria
 con un rubinetto d'irrigazione rotativo

R413-027175-030

R413-027175-070

Obturator 2,7 mm Ø
 Obturator 2.7 mm Ø
 Obturador de 2,7 mm Ø
 Otturatore 2,7 mm Ø



scharf / sharp / agudo / punta trequarti

R410-027175-001



konisch stumpf / conical blunt / cónico romo / punta conica smussa

R410-027175-002



stumpf / blunt / romo / punta cilindrica smussa

R410-027175-003

Endoskope für Arthroskopie
 Endoscopes for Arthroscopy
 Endoscopios para artroscopía
 Ottiche per artroscopia

Ø 2,7 mm

Arthroskop, autoklavierbar mit integrierter Faser zur Beleuchtung für diagnostische und operative Eingriffe,
 Ø 2,7 mm, Arbeitslänge 188 mm:
 Schulter

Arthroscope, autoclavable, with integrated fiber optic for illumination, for diagnostic and operation,
 Ø 2.7 mm, working length 188 mm:
 shoulder

Artroscopios (ópticas) autoclavables con fibraoptica incorporado para intervenciones diagnósticas y operativas,
 diámetro de 2,7 mm, largo útil 188 mm:
 hombro

Ottiche autoclavabili con fibre ottiche per interventi diagnostici e operativi,
 Ø 2,7 mm Lunghezza operativa 188 mm:
 spalla

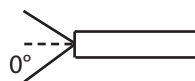
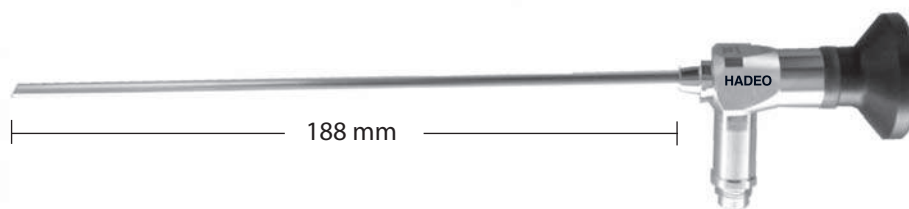

Geradeausblick
 Direct vision
 Vision directa
 Visione diretta angolo di

R400-027188-000

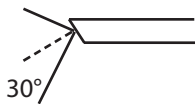

Vorausblick
 Foroblique vision
 ángulo de
 Visione grandangolo, angolo di

R400-027188-030

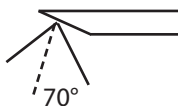

Seitblick
 Lateral vision
 ángulo de
 Visione laterale angolo di

R400-027188-070

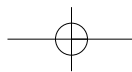

HADEO
INSTRUMENTE GERMANY

Trokarhülsen für Endoskope mit Ø 2,7 mm
Trocar sleeves for endoscopes with Ø 2.7 mm
Tubos para endoscopios de Ø 2,7 mm
Camicie per artroscopia, ottiche di Ø 2,7 mm

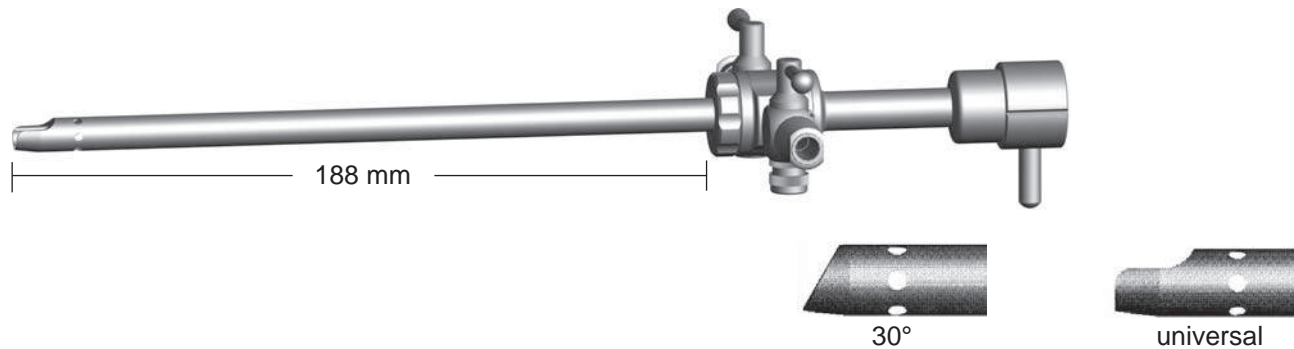

Trokar-Hülse mit zwei Spülhähnen, drehbar, 2,7 mm Ø
Trocar sleeve, with two stop cocks rotating, 2.7mm Ø
Tubo con dos llaves giratorias, de 2,7 mm Ø
Camicia per trocar, con due rubinetti d'irrigazione rotativi, 2,7 mm Ø

R414-027188-030

R414-027188-070

mit einem Spülhahn drehbar
with one stop cock rotating
con una llave giratoria
con un rubinetto d'irrigazione rotativo

R413-027188-030

R413-027188-070

Obturator 2,7 mm Ø
Obturator 2.7 mm Ø
Obturador de 2,7 mm Ø
Otturatore 2,7 mm Ø



scharf / sharp / agudo / punta trequarti

R410-027188-001



konisch stumpf / conical blunt / cónico romo / punta conica smussa

R410-027188-002



stumpf / blunt / romo / punta cilindrica smussa

R410-027188-003

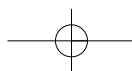

Saug- / Spülhandgriff pistolenförmig
 Suction / Irrigation handle pistol style
 Aspiración / irrigación manejo a pistola
 Impugnatura a pistola

Schaftrohr für Optik
 Shaft tube for scope
 Tubo para endoscopios
 Camicie per ottiche

2,7 mm	0°	188 mm	R415-027188-000
2,7 mm	30°	188 mm	R415-027188-030
4,0 mm	0°	175 mm	R415-040175-000
4,0 mm	30°	175 mm	R415-040175-030

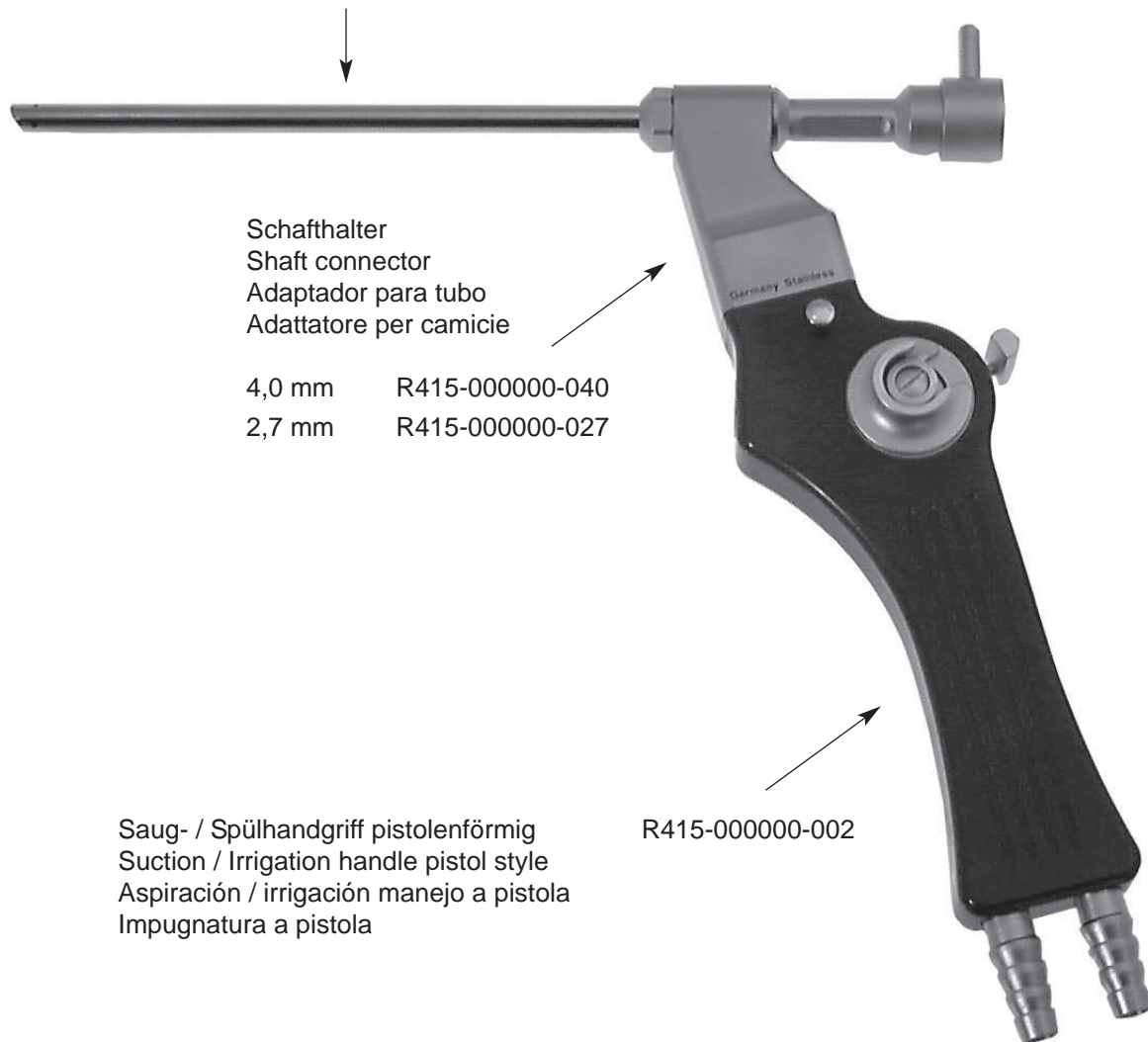

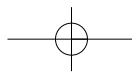
**HADEO**
INSTRUMENTE GERMANY

Überlastschutz
Overload protection
Protección de sobrecarga
Protezione contro sovraccarico

Für Arthroskopie-Stanzen mit anatomisch geformten Griff und Überlastschutz bitte am Ende der Artikel Nr. "P" hinzufügen.

For arthroscopy punches with anatomically designed handle and overload protection please add a "P" at the end of the catalogue no.

Para las pinzas de artroscopía con mango ergométrico y protección de sobrecarga, favor de especificar la referencia del catálogo con una "P" al final.

Per pinze con strumenti artroscopici con impugnatura anatomica e protezione contro sovraccarico prego aggiungere la lettera "P" alla fine del codice.

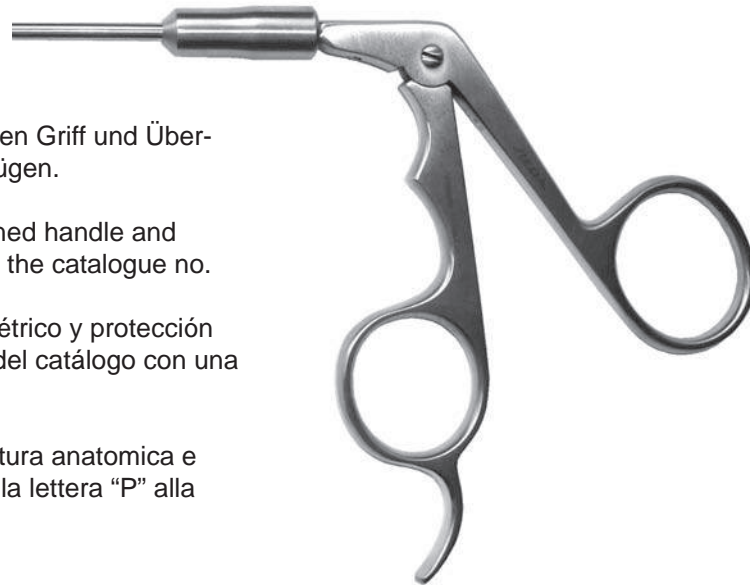

Für Arthroskopie-Stanzen mit ergonomisch geformten Griff bitte am Ende der Artikel Nr. "S" hinzufügen.

For arthroscopy punches with ergonomic designed handle please add a "S" at the end of the catalogue no.

Para las pinzas de artroscopía con mango ergonómico, favor de especificar la referencia del catálogo con una "S" al final.

Per pinze con strumenti artroscopici con impugnatura ergonomica prego aggiungere la lettera "S" alla fine del codice.

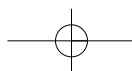

Hakenstanze, mit Schippe
Hook punch, scoope nose
Pinza cortante, de nariz aguda
Pinza uncinata, morso con paletta

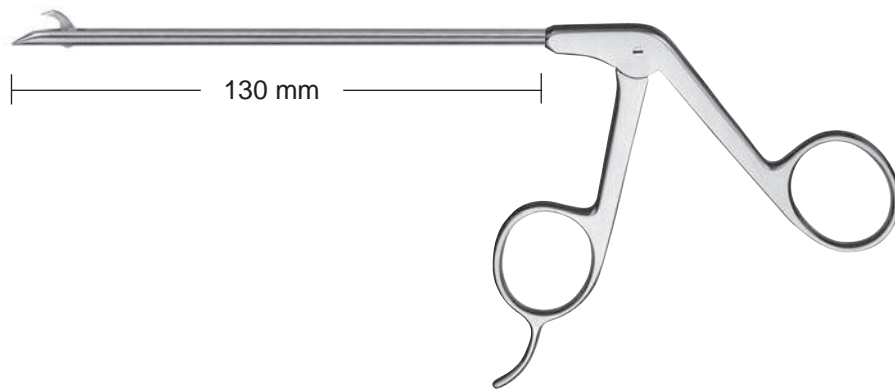

Hakenstanze mit Schippe
Hook punch, scoope nose
Pinza cortante, de nariz aguda
Pinza uncinata, morso con paletta
gerade / straight / recta / retta

3,4 mm Ø
cutting size 5 x 1,6

2,8 mm Ø
cutting size 4 x 1,2

R440-034130-000

R440-028130-000



30°

Schaft gebogen / shaft curved
vaina curva / curva:
rechts / right / derecha / destra
links / left / izquierda / sinistra

R440-034130-030

R440-028130-030

R440-034130-130

R440-028130-130



45°

rechts / right / derecha / destra
links / left / izquierda / sinistra

R440-034130-045

R440-028130-045

R440-034130-145

R440-028130-145



7°

aufwärts / upwards
hacia arriba / in alto

R440-034130-007

R440-028130-007



abwärts / downwards
hacia abajo / in basso

R440-034130-107

R440-028130-107



15°

aufwärts / upwards
hacia arriba / in alto

R440-034130-015

R440-028130-015



abwärts / downwards
hacia abajo / in basso

R440-034130-115

R440-028130-115

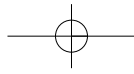

Hakenstanze, mit Schippe 15°
 Hook punch, scoope nose 15°
 Pinza cortante, de nariz aguda 15°
 Pinza uncinata, morso con paletta 15°

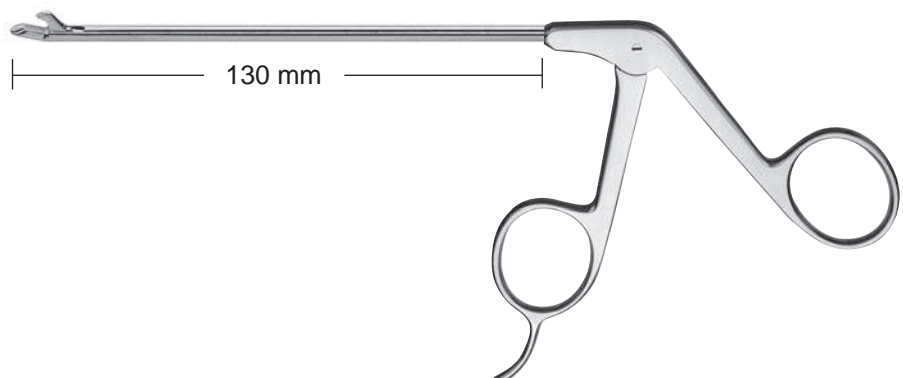

Hakenstanze mit Schippe
 Hook punch, scoope nose
 Pinza cortante, de nariz aguda
 Pinza uncinata, morso con paletta
 gerade / straight / recta / retta

3,4 mm Ø
 cutting size 5 x 1,6

2,8 mm Ø
 cutting size 4 x 1,2

R440-034130-200

R440-028130-200

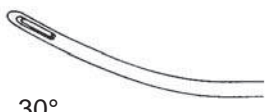

30°

Schaft gebogen / shaft curved
 vaina curva / curva:
 rechts / right / derecha / destra
 links / left / izquierda / sinistra

R440-034130-230

R440-028130-230

R440-034130-330

R440-028130-330



45°

rechts / right / derecha / destra
 links / left / izquierda / sinistra

R440-034130-245

R440-028130-245

R440-034130-345

R440-028130-345

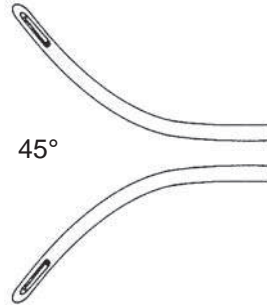

7°

aufwärts / upwards
 hacia arriba / in alto

R440-034130-207

R440-028130-207

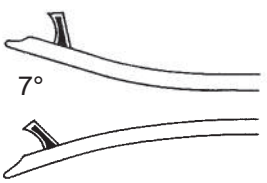

abwärts / downwards
 hacia abajo / in basso

R440-034130-307

R440-028130-307

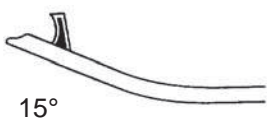

15°

aufwärts / upwards
 hacia arriba / in alto

R440-034130-215

R440-028130-215



abwärts / downwards
 hacia abajo / in basso

R440-034130-315

R440-028130-315

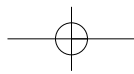

Hakenstanze, stumpf
Hook punch, blunt nose
Pinza cortante, de nariz roma
Pinza uncinata, smussa

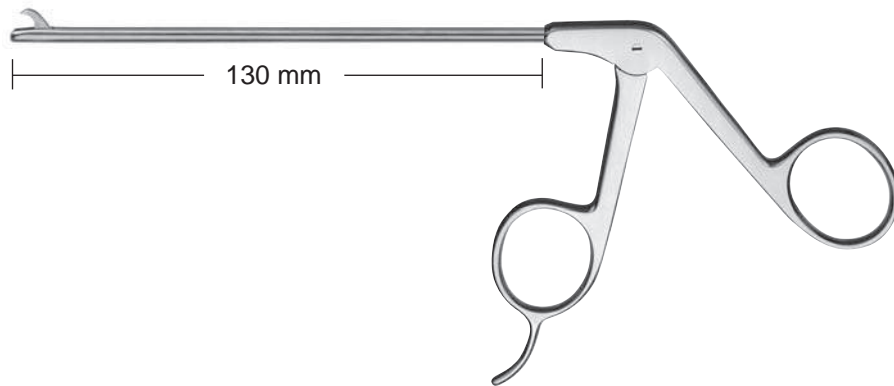

Hakenstanze, stumpf
Hook punch, blunt nose
Pinza cortante, de nariz roma
Pinza uncinata, smussa
gerade / straight / recta / retta

3,4 mm Ø
cutting size 5 x 1,6

2,8 mm Ø
cutting size 4 x 1,2

R441-034130-000

R441-028130-000



30°

Schaft gebogen / shaft curved
vaina curva / curva:
rechts / right / derecha / destra
links / left / izquierda / sinistra

R441-034130-030

R441-028130-030

R441-034130-130

R441-028130-130



45°

rechts / right / derecha / destra
links / left / izquierda / sinistra

R441-034130-045

R441-028130-045

R441-034130-145

R441-028130-145

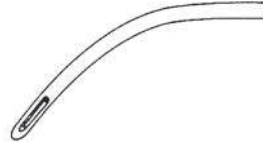

7°

aufwärts / upwards
hacia arriba / in alto

R441-034130-007

R441-028130-007

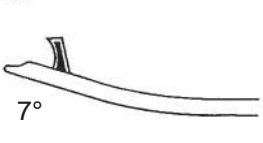

abwärts / downwards
hacia abajo / in basso

R441-034130-107

R441-028130-107



15°

aufwärts / upwards
hacia arriba / in alto

R441-034130-015

R441-028130-015

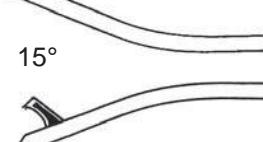

abwärts / downwards
hacia abajo / in basso

R441-034130-115

R441-028130-115

Hakenstanze, stumpf 15°
Hook punch, blunt nose 15°
Pinza cortante, de nariz roma 15°
Pinza uncinata, smussa 15°

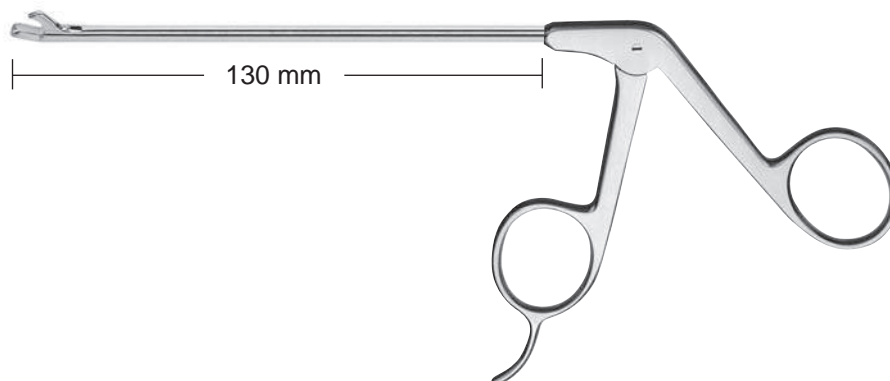

Hakenstanze, stumpf
Hook punch, blunt nose
Pinza cortante, de nariz roma
Pinza uncinata, smussa
gerade / straight / recta / retta

3,4 mm Ø
cutting size 5 x 1,6

2,8 mm Ø
cutting size 4 x 1,2

R441-034130-400

R441-028130-400

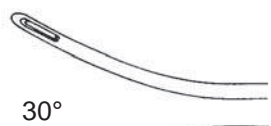

30°

Schaft gebogen / shaft curved
vaina curva / curva:
rechts / right / derecha / destra
links / left / izquierda / sinistra

R441-034130-430

R441-028130-430

R441-034130-630

R441-028130-630



45°

rechts / right / derecha / destra
links / left / izquierda / sinistra

R441-034130-445

R441-028130-445

R441-034130-645

R441-028130-645



7°

aufwärts / upwards
hacia arriba / in alto

R441-034130-407

R441-028130-407



abwärts / downwards
hacia abajo / in basso

R441-034130-607

R441-028130-607



15°

aufwärts / upwards
hacia arriba / in alto

R441-034130-415

R441-028130-415



abwärts / downwards
hacia abajo / in basso

R441-034130-615

R441-028130-615

Stanze, gezahnt
Punch, serrated
Pinza cortante aserrada
Pinza dentellata

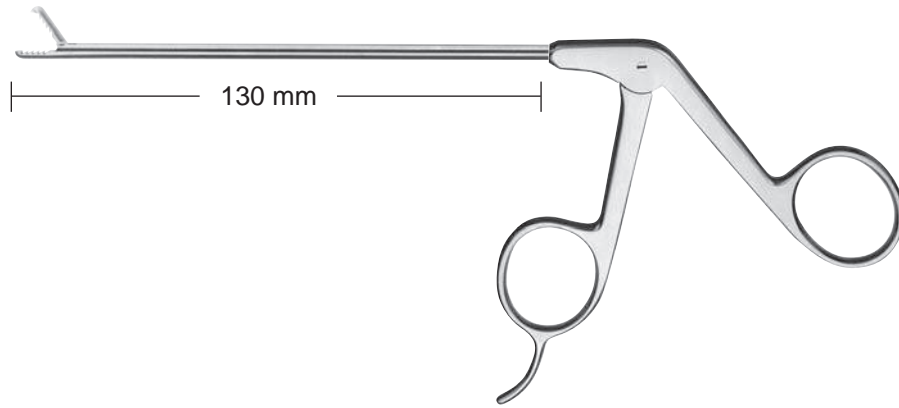

Stanze, gezahnt
Punch, serrated
Pinza cortante aserrada
Pinza dentellata
gerade / straight / recta / retta

3,4 mm Ø
cutting size 6 x 2

2,8 mm Ø
cutting size 5 x 1,6

R442-034130-000

R442-028130-000

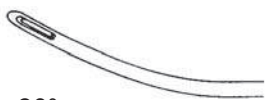

30°

Schaft gebogen / shaft curved
vaina curva / curva:
rechts / right / derecha / destra
links / left / izquierda / sinistra

R442-034130-030

R442-028130-030

R442-034130-130

R442-028130-130



45°

rechts / right / derecha / destra
links / left / izquierda / sinistra

R442-034130-045

R442-028130-045

R442-034130-145

R442-028130-145



7°

aufwärts / upwards
hacia arriba / in alto
abwärts / downwards
hacia abajo / in basso

R442-034130-007

R442-028130-007

R442-034130-107

R442-028130-107



15°

aufwärts / upwards
hacia arriba / in alto
abwärts / downwards
hacia abajo / in basso

R442-034130-015

R442-028130-015

R442-034130-115

R442-028130-115

Stanze, gezahnt „Duck“ Form
Punch, serrated, „Duck“ shaped
Pinza cortante, aserrada, pico de pato
Pinza dentellata, morso con paletta

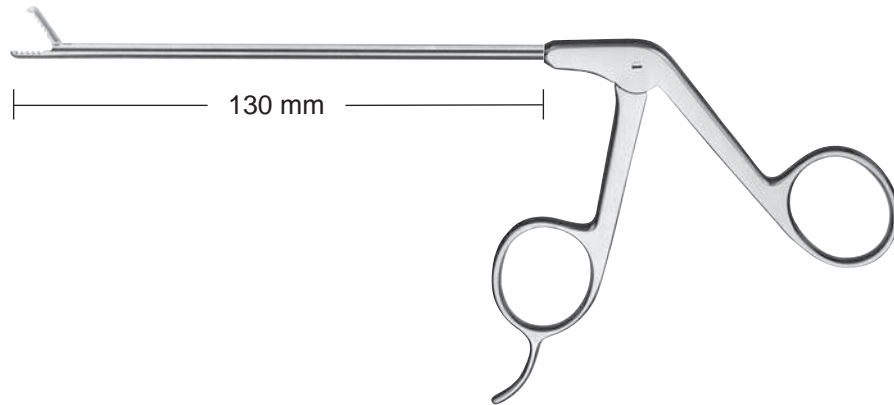

Stanze, gezahnt „Duck“ Form 15°
Punch, serrated, „Duck“ shaped 15°
Pinza cortante, aserrada, pico de pato 15°
Pinza dentellata, morso con paletta 15°

gerade / straight / recta / retta

3,4 mm Ø
cutting size 6 x 2

2,8 mm Ø
cutting size 5 x 1,6

R441-034130-200

R441-028130-200



30°

Schaft gebogen / shaft curved
vaina curva / curva:

rechts / right / derecha / destra

links / left / izquierda / sinistra

R441-034130-230

R441-028130-230

R441-034130-330

R441-028130-330



45°

rechts / right / derecha / destra

links / left / izquierda / sinistra

R441-034130-245

R441-028130-245

R441-034130-345

R441-028130-345



7°

aufwärts / upwards
hacia arriba / in alto

R441-034130-207

R441-028130-207



abwärts / downwards
hacia abajo / in basso

R441-034130-307

R441-028130-307



15°

aufwärts / upwards
hacia arriba / in alto

R441-034130-215

R441-028130-215



abwärts / downwards
hacia abajo / in basso

R441-034130-315

R441-028130-315

Stanze, gezahnt, lang
Punch, serrated, long
Pinza cortante, largo
Pinza dentellata, lungo

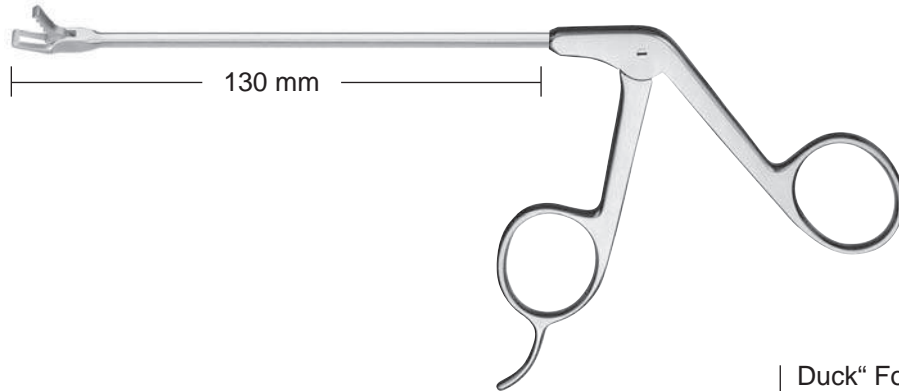

Standard



Duck

gerade / straight / recta / retta

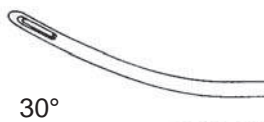

30°

Schaft gebogen / shaft curved
vaina curva / curva:

rechts / right / derecha / destra
links / left / izquierda / sinistra



45°

rechts / right / derecha / destra
links / left / izquierda / sinistra



7°

aufwärts / upwards
hacia arriba / in alto



abwärts / downwards
hacia abajo / in basso



15°

aufwärts / upwards
hacia arriba / in alto



abwärts / downwards
hacia abajo / in basso

Standard	Duck“ Form Duck“ shaped pico de pato morso con paletta
3,4 mm Ø cutting size 6 x 3,5 R444-034130-000	3,4 mm Ø cutting size 6 x 3,5 R444-034130-200
R444-034130-030	R444-034130-230
R444-034130-130	R444-034130-330
R444-034130-045	R444-034130-245
R444-034130-145	R444-034130-345
R444-034130-007	R444-034130-207
R444-034130-107	R444-034130-307
R444-034130-015	R444-034130-215
R444-034130-115	R444-034130-315

Stanze, gezahnt, breit
Punch, serrated, wide
Pinza cortante, aserrada, ancho
Pinza dentellata, largo

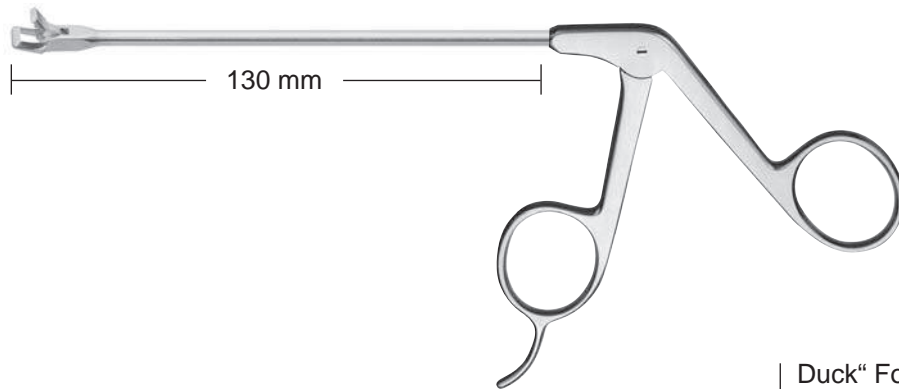

Standard



Duck

gerade / straight / recta / retta



30°

Schaft gebogen / shaft curved
vaina curva / curva:

rechts / right / derecha / destra
links / left / izquierda / sinistra



45°

rechts / right / derecha / destra
links / left / izquierda / sinistra



7°

aufwärts / upwards
hacia arriba / in alto



abwärts / downwards
hacia abajo / in basso



15°

aufwärts / upwards
hacia arriba / in alto



abwärts / downwards
hacia abajo / in basso

Standard	Duck“ Form Duck“ shaped pico de pato morso con paletta
3,4 mm Ø cutting size 4 x 4 R443-034130-000	3,4 mm Ø cutting size 4 x 4 R443-034130-200
R443-034130-030	R443-034130-230
R443-034130-130	R443-034130-330
R443-034130-045	R443-034130-245
R443-034130-145	R443-034130-345
R443-034130-007	R443-034130-207
R443-034130-107	R443-034130-307
R443-034130-015	R443-034130-215
R443-034130-115	R443-034130-315

Stanze, gezahnt, extra breit
Punch, serrated, extra wide
Pinza cortante, aserrada, adicional ancho
Pinza dentellata, speciale largo

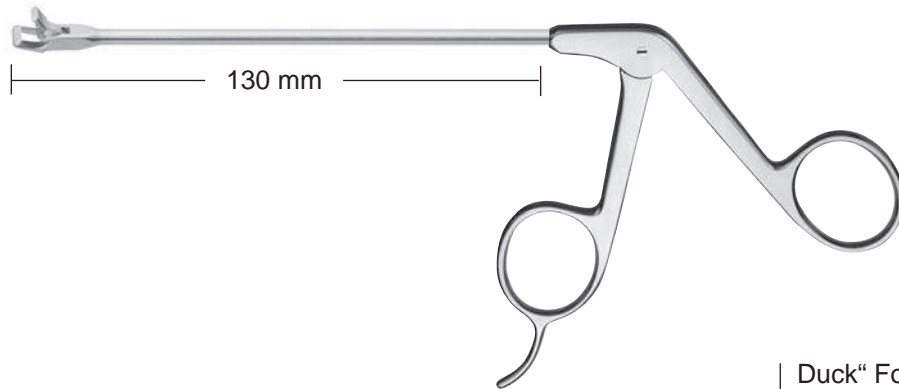

Standard



Duck

gerade / straight / recta / retta

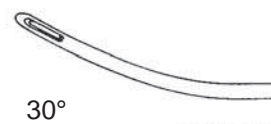

30°

Schaft gebogen / shaft curved
vaina curva / curva:

rechts / right / derecha / destra
links / left / izquierda / sinistra



45°

rechts / right / derecha / destra
links / left / izquierda / sinistra



7°

aufwärts / upwards
hacia arriba / in alto



abwärts / downwards
hacia abajo / in basso



15°

aufwärts / upwards
hacia arriba / in alto



abwärts / downwards
hacia abajo / in basso

Standard	Duck“ Form Duck“ shaped pico de pato morso con paletta
3,4 mm Ø cutting size 5 x 4,5 R446-034130-000	3,4 mm Ø cutting size 5 x 4,5 R446-034130-200
R446-034130-030	R446-034130-230
R446-034130-130	R446-034130-330
R446-034130-045	R446-034130-245
R446-034130-145	R446-034130-345
R446-034130-007	R446-034130-207
R446-034130-107	R446-034130-307
R446-034130-015	R446-034130-215
R446-034130-115	R446-034130-315

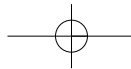

Mikro-Scheren Stanze
Slender Punch
Micro pinza cortante
Micropinza Basket

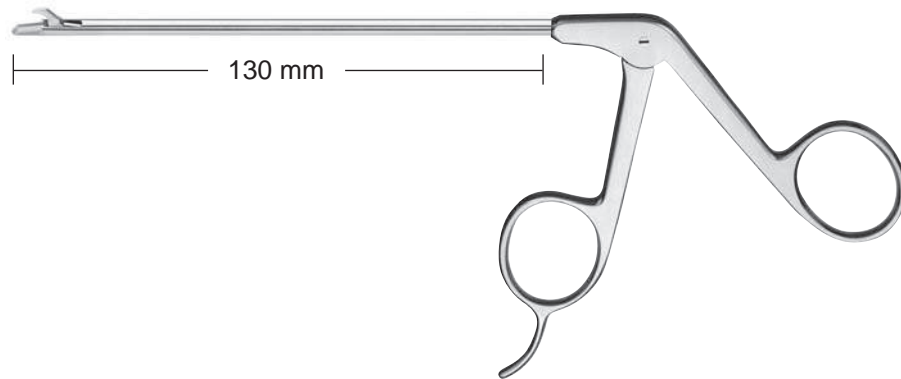

3,4 mm Ø
cutting size 0,8 x 5



gerade / straight / recta / retta

R447-034130-000

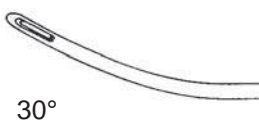

30°

Schaft gebogen / shaft curved
vaina curva / curva:
rechts / right / derecha / destra
links / left / izquierda / sinistra

R447-034130-030

R447-034130-130



45°

rechts / right / derecha / destra
links / left / izquierda / sinistra

R447-034130-045

R447-034130-145



7°

aufwärts / upwards
hacia arriba / in alto

R447-034130-007



abwärts / downwards
hacia abajo / in basso

R447-034130-107



15°

aufwärts / upwards
hacia arriba / in alto

R447-034130-015



abwärts / downwards
hacia abajo / in basso

R447-034130-115

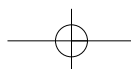

Stanze oval
Oval Punch
Pinza ovale
Pinza oval

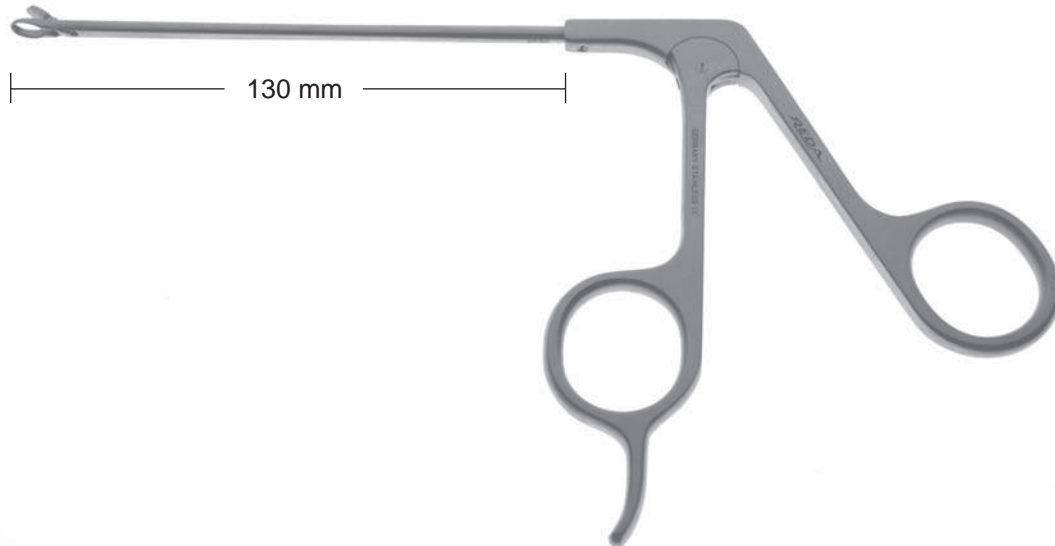

gerade / straight / recta / retta

3,4 mm Ø
cutting size 4,4 mm

R448-034130-000

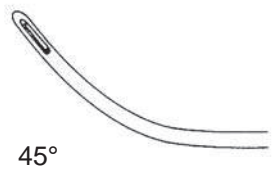

rechts / right / derecha / destra

R448-034130-045

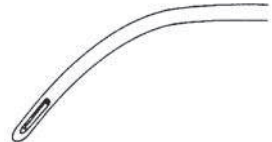

links / left / izquierda / sinistra

R448-034130-145

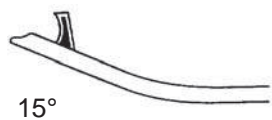

aufwärts / upwards / hacia arriba / in alto

R448-034130-015

aufgewinkelt / angled up / pico de pato / paletta

R448-034130-200

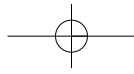

Arthroskopie-Stanzen
 Arthroscopy Punches
 Pinzas cortantes
 Pinze taglienti

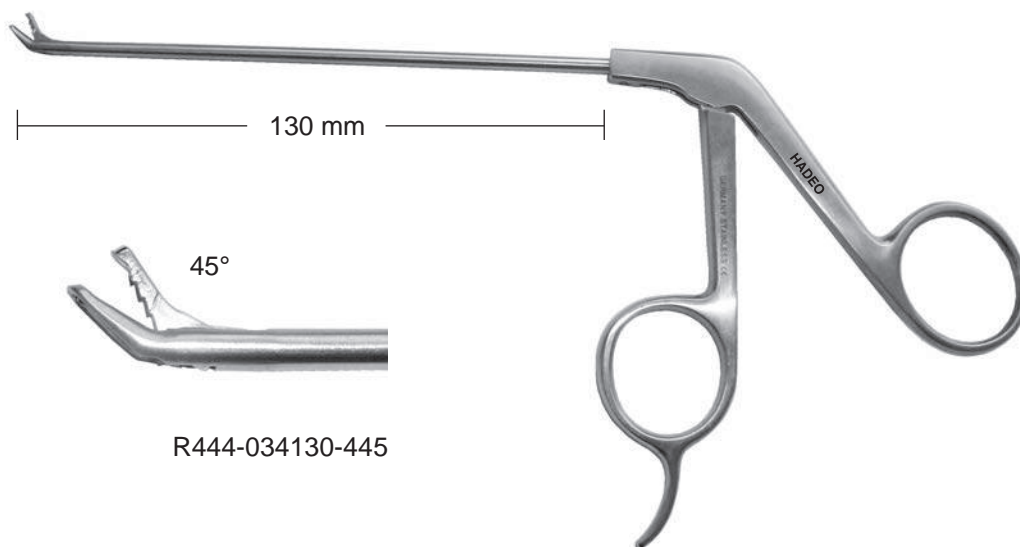

R444-034130-445

Biopsie-Stanze, 45° nach oben schneidend, 3,4 mm Ø
 Biopsy punch, 45° upcurved cutting, 3.4 mm Ø
 Pinza para biopsia, 45° corte hacia arriba, 3,4 mm Ø
 Pinza per biopsia, 45° tagliente in alto, 3,4 mm Ø



cutting size 3,8 x 2,4

Antrumstanze durchschneidend, 3,5 mm Ø, 130 mm Nutzlänge
 Antrum punch through cutting, 3.5 mm Ø, 130 mm working length
 Pinza Antrum tajante, 3,5 mm Ø, largo útil de 130 mm
 Pinza Antrum tagliente, 3,5 mm Ø, 130 mm lunghezza

- | | |
|-------------------------------------|-----------------|
| oben / upward / arriba / alto | R448-035130-000 |
| rechts / right / derecha / destra | R448-035130-600 |
| links / left / izquierda / sinistra | R448-035130-800 |
| unten / downward / abajo / basso | R448-035130-900 |

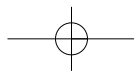

Biopsie-Stanze, seitlich schneidend 3,4 mm Ø
 Biopsy punch, side-biter 3.4 mm Ø
 Pinza para biopsia, corte lateral 3,4 mm Ø
 Pinza per biopsia, taglio laterale 3,4 mm Ø

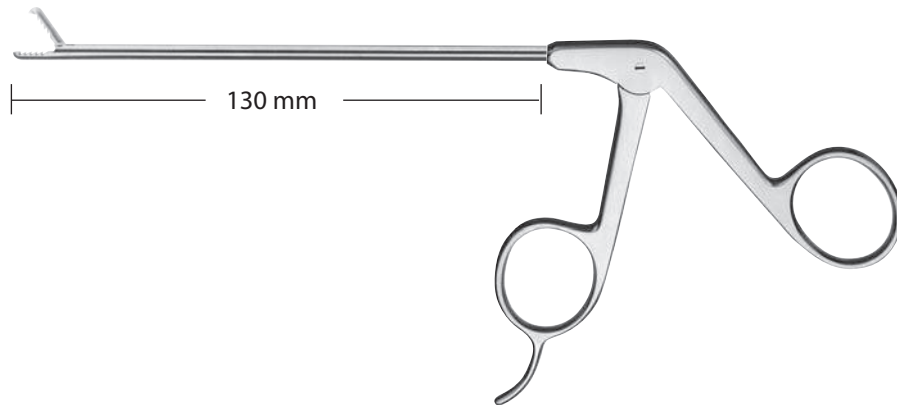

Biopsie-Stanze, seitlich schneidend 3,4 mm Ø
 Biopsy punch, side-biter 3.4 mm Ø
 Pinza para biopsia, corte lateral 3,4 mm Ø
 Pinza per biopsia, taglio laterale 3,4 mm Ø

mit Schippe
 scoope nose
 de nariz aguda
 morso con paletta

stumpf
 blunt nose
 de nariz roma
 smussa

Maulteil gewinkelt / jaw angled / boca angulada / morso angolato:



90°

rechts / right / derecha / destra

R440-034130-590

R441-034130-590

links / left / izquierda / sinistra

R440-034130-790

R441-034130-790

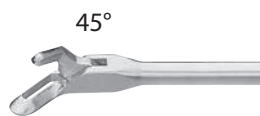

45°

rechts / right / derecha / destra

R440-034130-545

R441-034130-545

links / left / izquierda / sinistra

R440-034130-745

R441-034130-745

Biopsie-Stanze, seitlich schneidend, breit
 Biopsy punch, side-biter, wide
 Pinza para biopsia, corte lateral, ancho
 Pinza per biopsia, taglio laterale, largo

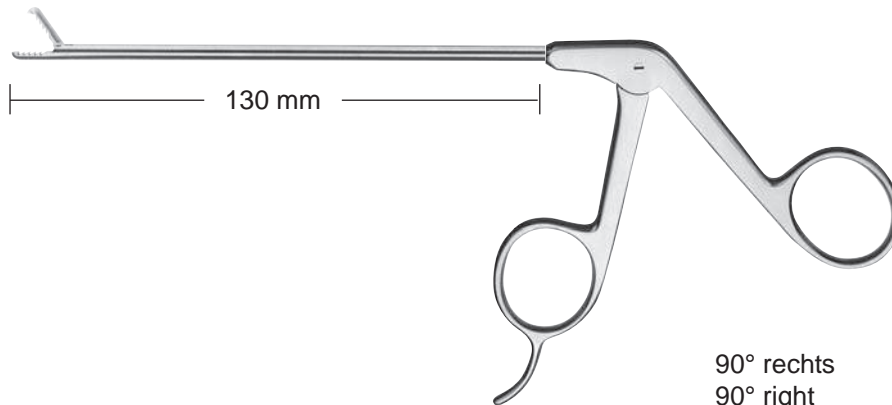

gerade / straight / recta / retta

90° rechts
 90° right
 90° derecha
 90° destra

90° links
 90° left
 90° izquierda
 90° sinistra

3,4 mm Ø
 cutting size 4 x 4
 R443-034130-590

3,4 mm Ø
 cutting size 4 x 4
 R443-034130-790



30°

Schaft gebogen / shaft curved
 vaina curva / curva:

rechts / right / derecha / destra
 links / left / izquierda / sinistra

R443-034130-530
 R443-034130-630

R443-034130-730
 R443-034130-830



45°

rechts / right / derecha / destra
 links / left / izquierda / sinistra

R443-034130-545
 R443-034130-645

R443-034130-745
 R443-034130-845



7°

aufwärts / upwards
 hacia arriba / in alto

R443-034130-507

R443-034130-707



abwärts / downwards
 hacia abajo / in basso

R443-034130-607

R443-034130-807



15°

aufwärts / upwards
 hacia arriba / in alto

R443-034130-515

R443-034130-715



abwärts / downwards
 hacia abajo / in basso

R443-034130-615

R443-034130-815

Arthroskopie-Rotationszange
 Arthroscopy rotary punch
 Pinza para biopsia rotatoria
 Pinza rotante



Arthroskopie-Rotationszange für große Schnitte
 100 mm Nutzlänge, Ringgriff Standard

Arthroscopy rotary punch for big cutting size
 100 mm working length, grip handle

Pinza para biopsia rotatoria, para cortes grandes,
 largo útil de 100 mm, mango de anillo corriente

Pinza rotante per tagli grossi lunghezza
 lavorativa 100 mm impugnatura ad anelli standard



90° rechts / right
 90° hacia la derecha / 90° a destra

R449-035100-090 C



90° links / left
 90° hacia la izquierda / 90° a sinistra

R449-035100-190 C

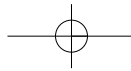

HADEO
INSTRUMENTE GERMANY

Arthroskopie-Rotationszange
Arthroscopy rotary punch
Pinza para biopsia rotatoria
Pinza rotante

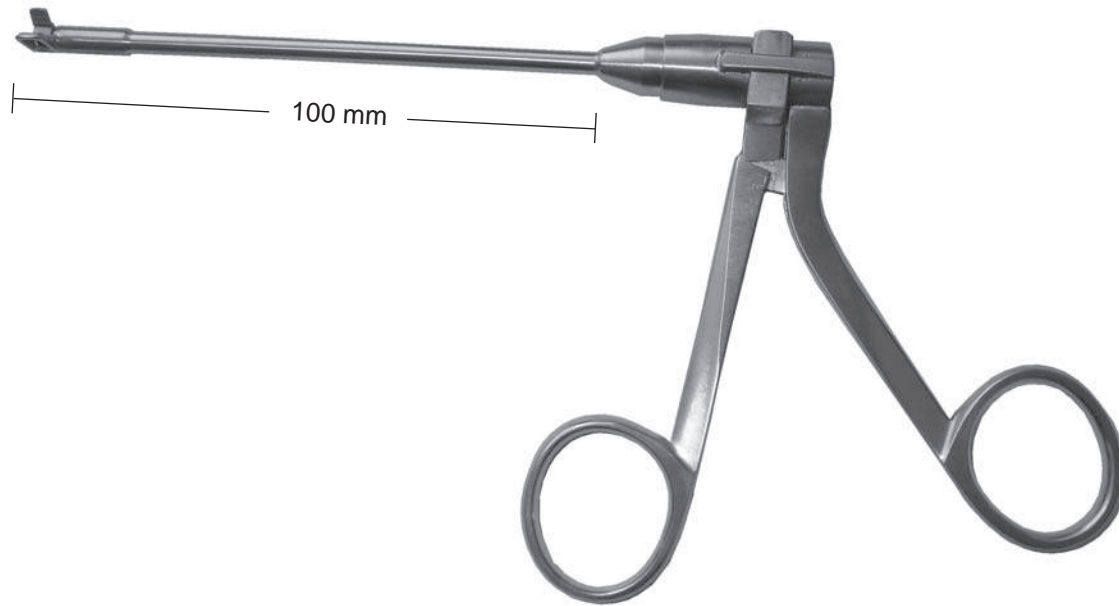

Arthroskopie-Rotationszange für große Schnitte
100 mm Nutzlänge, Ringgriff Standard

Arthroscopy rotary punch for big cutting size
100 mm working length, grip handle

Pinza para biopsia rotatoria, para cortes grandes,
largo útil de 100 mm, mango de anillo corriente

Pinza rotante per tagli grossi lunghezza
lavorativa 100 mm impugnatura ad anelli standard



90° rechts / right
90° hacia la derecha / 90° a destra

R449-035100-090



90° links / left
90° hacia la izquierda / 90° a sinistra

R449-035100-190

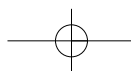

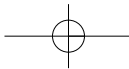

HADEO
INSTRUMENTE GERMANY

Arthroskopie-Saugstanze
Arthroscopy suction punch
Pinza de succión
Pinza d'aspirazione

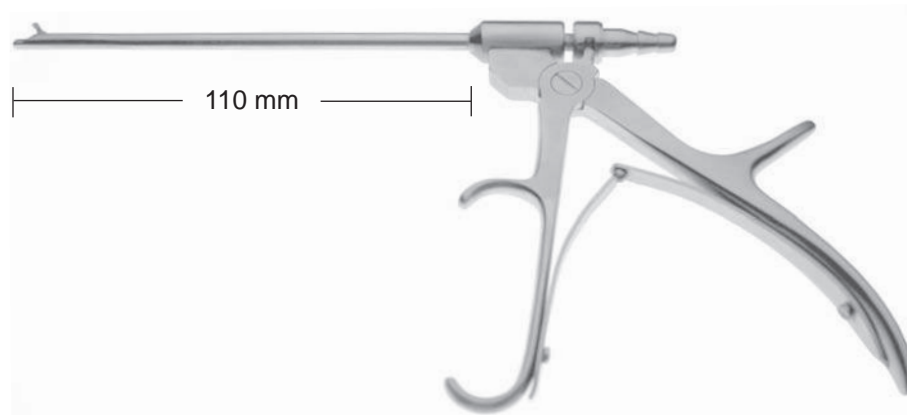

unten schneidend
downwards cutting
corte hacia abajo
tagliente in basso

R446-040110-01



durchschneidend
through cutting
cortante
tagliente

R446-040110-02

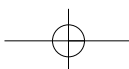

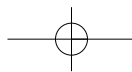

HADEO
INSTRUMENTE GERMANY

Arthroskopie-Saugstanze drehbar 360°
Arthroscopy suction punch rotatable 360°
Pinza de succión, girable en ángulo de 360°
Pinza d'aspirazione, rotativa 360°

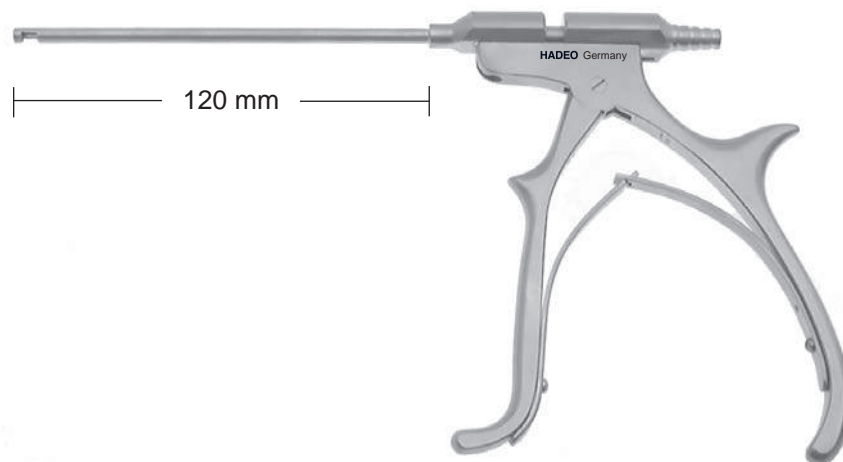

Arthroskopie-Saugstanze drehbar 360°
zerlegbar, 120 mm Nutzlänge, 4,5 mm Ø

R446-045130-00 R

Arthroscopy suction punch rotatable 360°
dismountable, 120 mm working length 4.5 mm Ø

Pinza de succión, girable en 360°
desmontable, largo útil de 120 mm, 4,5 mm Ø

Pinza d'aspirazione, rotativa 360°
modulare, lunghezza lavorativa 120 mm, 4,5 mm Ø

Schneidehülse allein für Saugstanze
Cutting sleeve only for suction punch
Tubo cortante suelto para la pinza arriba mencionada
Guaina tagliente sola per pinza d'aspirazione

R446-045130-00 I

Mantelrohr allein
Outer tube alone
Tubo exterior
Camica intercambiabile

R446-045130-00 A

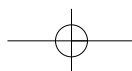

Hakenschere
Hook scissors
Tijera en forma de gancho
Forbice uncinata

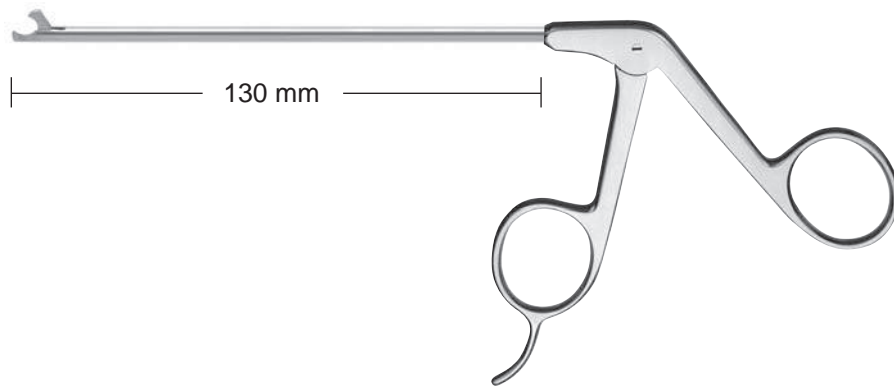

Hakenschere
Hook scissors
Tijera en forma de gancho
Forbice uncinata
gerade / straight / recta / retta

3,4 mm Ø

2,8 mm Ø

R450-034130-000

R450-028130-000



30°

Schaft gebogen / shaft curved
vaina curva / curva:
rechts / right / derecha / destra
links / left / izquierda / sinistra

R450-034130-030

R450-028130-030

R450-034130-130

R450-028130-130



45°

rechts / right / derecha / destra
links / left / izquierda / sinistra

R450-034130-045

R450-028130-045

R450-034130-145

R450-028130-145



45°

Maulteil gewinkelt / jaw angled
boca angulada / morso angolato:
rechts / right / derecha / destra
links / left / izquierda / sinistra

R450-034130-245

R450-034130-345

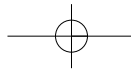

HADEO
INSTRUMENTE GERMANY

Schere gezahnt
Scissors serrated
Tijera dentada
Forbici dentellate

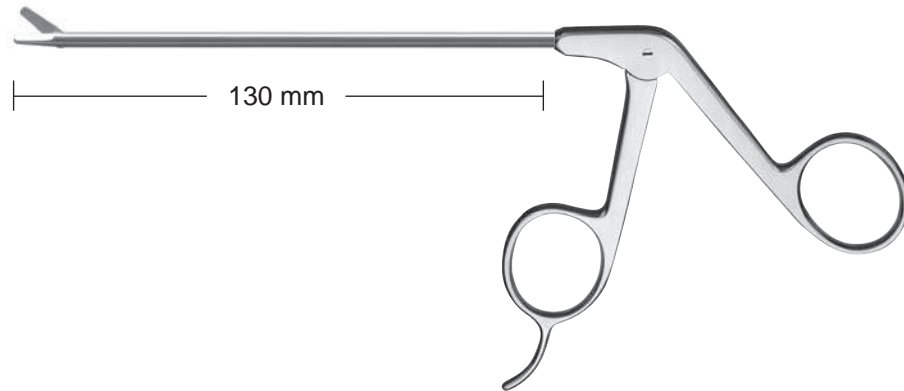

3,4 mm Ø



Schere gezahnt
Scissors serrated
Tijera dentada
Forbici dentellate

gerade / straight / recta / retta

R451-034130-000

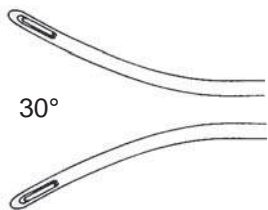

30°

Schaft gebogen / shaft curved
vaina curva / curva:

rechts / right / derecha / destra

R451-034130-030

links / left / izquierda / sinistra

R451-034130-130

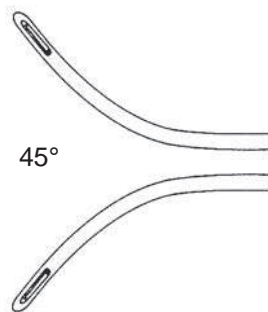

45°

rechts / right / derecha / destra

R451-034130-045

links / left / izquierda / sinistra

R451-034130-145

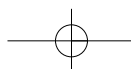

Arthroskopie-Faßzangen
 Arthroscopy grasper
 Pinzas de agarre para artroscopía
 Pinze da presa per artroscopia

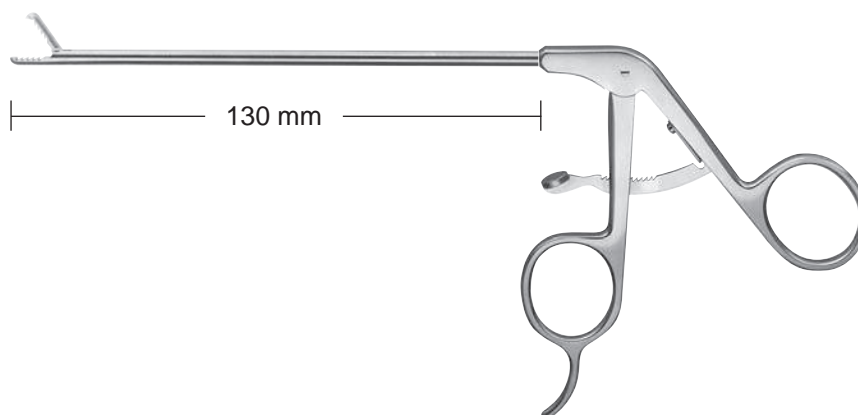

Greif-Zange
 Grasping Forceps
 Pinza de agarre
 Pinza da presa, morso robusto a cocodrillo

4,5 mm Ø R430-045130-000
 3,4 mm Ø R430-034130-000
 2,8 mm Ø R430-028130-000

Greif-Zange mit Sperre
 Grasping forceps, with ratchet
 Pinza de agarre con cremallera
 Pinza da presa dotata di cremagliera

4,5 mm Ø R431-045130-000
 3,4 mm Ø R431-034130-000
 2,8 mm Ø R431-028130-000



Faß-Zange mit Mauszahn
 Grasping forceps with mouse teeth
 Pinza de agarre con diente de ratón
 Pinza da presa con dente di topo

3,4 mm Ø R432-034130-000
 2,8 mm Ø R432-028130-000

Faß-Zange, Mauszahn und Sperre
 Grasping forceps with mouse teeth and ratchet
 Pinza de agarre con diente de ratón, y cremallera
 Pinza da presa con dente di topo dotata di cremagliera

3,4 mm Ø R433-034130-000
 2,8 mm Ø R433-028130-000



Faß-Biopsie-Zange
 Grasping and biopsy forceps
 Pinza de agarre para biopsia
 Pinza da presa per biopsia

3,4 mm Ø R434-034130-000
 2,8 mm Ø R434-028130-000

Faß-Biopsie-Zange mit Sperre
 Grasping and biopsy forceps with ratchet
 Pinza de agarre para biopsia con cremallera
 Pinza da presa per biopsia dotata di cremagliera

3,4 mm Ø R435-034130-000
 2,8 mm Ø R435-028130-000

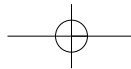

HADEO
INSTRUMENTE GERMANY

Biopsie-Zange
Biopsy forceps
Pinza de biopsia
Pinza da biopsia

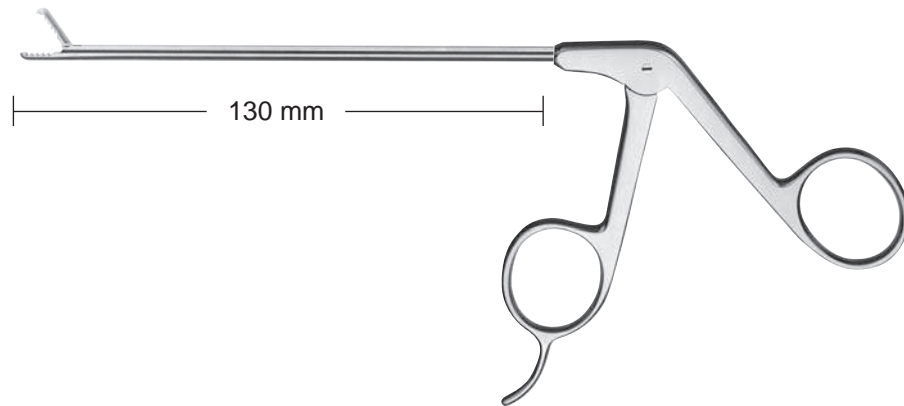

Biopsie-Zange
Biopsy forceps
Pinza de biopsia
Pinza da biopsia

3,4 mm Ø R436-034130-000
2,8 mm Ø R436-028130-000



Biopsie-Zange, mit Dorn
Biopsy forceps, with spike
Pinza de biopsia, con pico
Pinza da biopsia, con picco

3,4 mm Ø R436-034130-001
2,8 mm Ø R436-028130-001

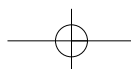

Arthroskopie-Zangen
 Arthroscopy forceps
 Pinzas para artroscopía
 Pinze per artroscopia

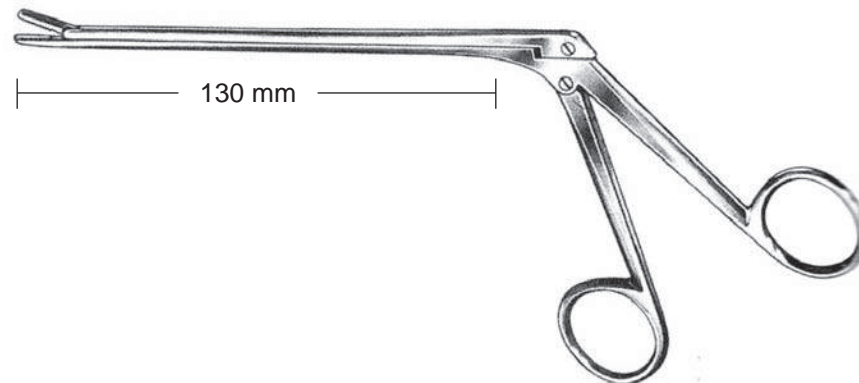

Meniskus-Faßzange kräftig
 Meniscus grasping forceps, strong
 Pinza de agarre para el menisco, muy fuerte
 Pinza da presa, robusta, per menisco

2 x 10 mm	R436-042150-210
3 x 10 mm	R436-042150-310
4 x 10 mm	R436-042150-410

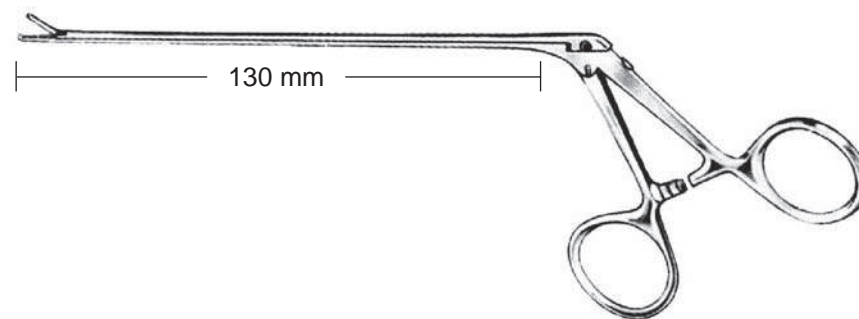

Mini-Faß-Zange mit Mauszahn und Sperre, 2,2 mm Ø
 Mini grasper with mouse teeth and ratchet, 2.2 mm Ø
 Pinza de agarre, modelo muy fino, con diente de ratón y cremallera, 2,2 mm Ø
 Mini pinza da presa con dente di topo, dotata di cremagliera, 2,2 mm Ø

R437-022130-000

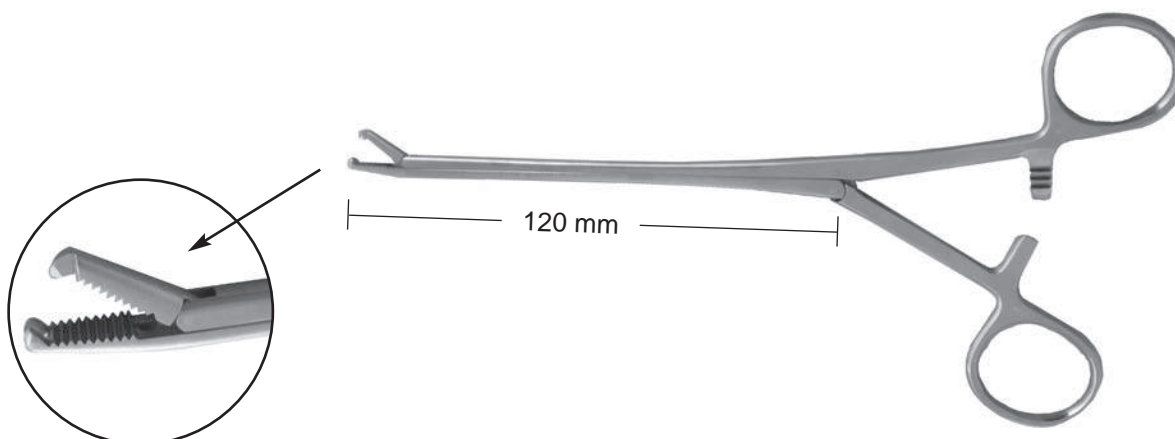

Meniskusretraktor gerade mit Mauszahn und Sperre
 Meniscus retractor straight with mouse teeth and ratchet
 Retractor de menisco, recto, con diente de ratón y cremallera
 Retratore per menisco, retto, con dente di topo dotato di cremagliera

R438-035130-000

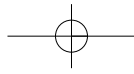

Faden Zangen
Ligature forceps
Pinzas para ligadura
Pinze per legatura

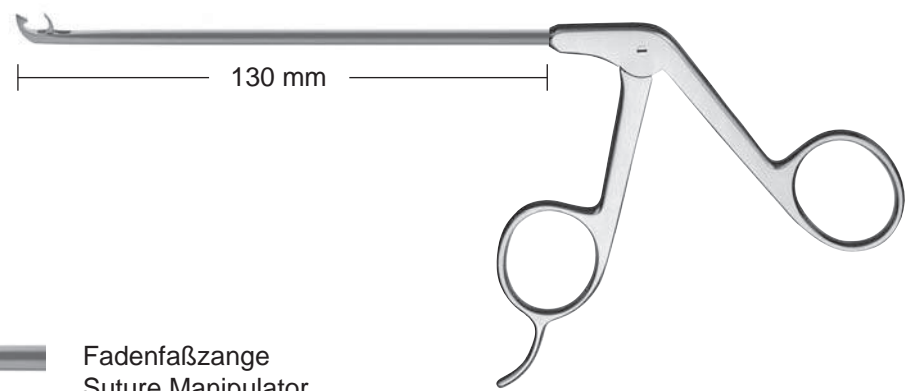

Fadenfaßzange
Suture Manipulator
pinza de agarre para sutura
pinza da presa per legature

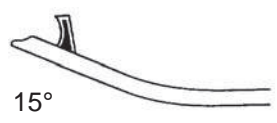

gerade / straight / recta / retta

R439-034130-000



15°

aufwärts / upwards
hacia arriba / in alto

R439-034130-015



45°

rechts / right / derecha / destra

R439-034130-045



links / left / izquierda / sinistra

R439-034130-145



Fadenfänger gerade
Suture grasper
pinza de agarre recta
prendifilo retto

R439-034130-100

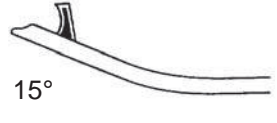

15°

aufwärts / upwards
hacia arriba / in alto

R439-034130-115



Faden Punch gerade
Suture punch straight
pinza de agarre recta
pinza perforatrice

R439-034130-200



45° aufwärts / upwards
45° hacia arriba / in alto

R439-034130-300



10° aufwärts / upwards
10° hacia arriba / in alto

R439-034130-310

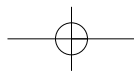

Hand-Instrumente
 Hand instruments
 Instrumentos manuales
 Strumenti manuali



Hakensonde graduiert
 Hook probe graduated
 Gancho explorador graduado
 Palpatore graduato ad uncino
 3 mm
 5 mm

R490-030110-03
 R490-030110-05



Skalpellmesser
 Scalpel knife
 Cuchillo de bisturí
 Coltello a bisturi

R490-030110-11



Hakenmesser
 Hook knife
 Cuchillo en forma de gancho
 Coltello uncinato

R490-030110-12



Messer retrograd
 Knife, retrograde
 Cuchillo retrógrado
 Coltello retrogrado

R490-030110-13

Banana-Messer
 Banana knife
 Cuchillo en forma de plátano
 Coltello a banana



glatt / smooth / liso / liscio

R490-030110-14



gezahnt / serrated / dentado / dentellato

R490-030110-15



Rosettenmesser
 Rosette knife
 Cuchillo en forma de roseta
 Coltello a rosetta

R490-030110-16

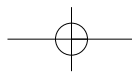

HADEO
INSTRUMENTE GERMANY

Hand-Instrumente
Hand instruments
Instrumentos manuales
Strumenti manuali con impugnatura fissa



Meniskotom nach Smillie
Smillie knife
Meniscótomo de Smillie
Meniscotomo di Smillie
3 mm
5 mm
7 mm

R490-030110-43
R490-030110-45
R490-030110-47



Messer sichelförmig
Sickle knife
Cuchillo en forma de hoz
Coltello a falce

R490-030110-17



Löffel, 3 mm Ø
Spoon, 3 mm Ø
Cucharilla, 3 mm Ø
Cucchiaio 3 mm Ø

R490-030110-21



Ring-Kürette
Ring curette
Cureta en forma de anillo
Curetta ad anello

3 mm Ø
5 mm Ø
7 mm Ø

R490-030110-31
R490-030110-32
R490-030110-33



Knorpelfeile
Cartilage file
Lima para cartilago
Lima per cartilagine

R490-030110-51

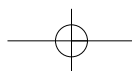

Hand-Instrumente, zweiteilig
 Hand instruments, two parts
 Instrumentos manuales, de dos partes
 Strumenti manuali, a due parti



Griff allein mit Spannzange
 Handle alone with wrench
 Mango solo con adaptador de fijación
 Impugnatura sola con adattatore di fissazione

R 492-000000-000



Meniskotom nach Smillie
 Smillie knife
 Meniscótomo de Smillie
 Meniscotomo di Smillie
 3 mm
 5 mm
 7 mm

R492-030110-43

R492-030110-45

R492-030110-47



Messer sichelförmig
 Sichel knife
 Cuchillo en forma de hoz
 Coltello a falce

R492-030110-17



Löffel, 3 mm Ø
 Spoon, 3 mm Ø
 Cucharilla, 3 mm Ø
 Cucchiaino 3 mm Ø

R492-030110-21



Ring-Kürette, 3 mm Ø
 Ring curette, 3 mm Ø
 Cureta en forma de anillo, 3 mm Ø
 Curetta ad anello, 3 mm Ø

R492-030110-31



Ring-Kürette, 7 mm Ø
 Ring curette, 7 mm Ø
 Cureta en forma de anillo, 7 mm Ø
 Curetta ad anello, 7 mm Ø

R492-030110-32



Knorpelfeile
 Cartilage file
 Lima para cartilago
 Lima per cartilagine

fein / fine / fina / fina
 grob / coarse / gruesa / grano grosso

R492-030110-51

R492-030110-52

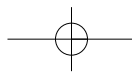

HADEO
INSTRUMENTE GERMANY

Hand-Instrumente, zweiteilig
Hand instruments, two parts
Instrumentos manuales, de dos partes
Strumenti manuali, a due parti



Hakensonde graduiert
Hook probe graduated
Gancho explorador graduado
Palpatore graduato ad uncino
2,5 mm
3,5 mm

R492-030110-03
R492-030110-04

Hakensonde spitz
Palpation hook pointed
Gancho explorador agudo
Palpatore acuto

R492-030110-00



Skalpellmesser
Scalpel knife
Cuchillo de bisturí
Coltello a bisturi

R492-030110-11



Hakenmesser
Hook knife
Cuchillo en forma de gancho
Coltello uncinato

R492-030110-12



Messer retrograd
Knife retrograde
Cuchillo retrógrado
Coltello retrogrado

R492-030110-13

Banana-Messer
Banana knife
Cuchillo en forma de plátano
Coltello a banana



glatt / smooth / liso / liscio

R492-030110-14



gezahnt / serrated / dentado / dentellato

R492-030110-15



Rosettenmesser
Rosette knife
Cuchillo en forma de roseta
Coltello a rosetta

R492-030110-16

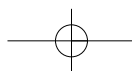

Hand-Instrumente
 Hand instruments
 Instrumentos manuales
 Strumenti manuali con impugnatura fissa



Meniskotom nach Smillie
 Smillie meniscotome
 Meniscótomo de Smillie
 Meniscotomo di Smillie
 3 mm
 5 mm

R494-030110-43
 R494-030110-45



Messer sichelförmig
 Sichel knife
 Cuchillo en forma de hoz
 Coltello a falce

R494-030110-17



Löffel, 3 mm Ø
 Spoon 3 mm Ø
 Cucharilla, 3 mm Ø
 Cucchiaino 3 mm Ø

R494-030110-21



Ring-Kürette, 3 mm Ø
 Ring curette, 3 mm Ø
 Cureta en forma de anillo, 3 mm Ø
 Curetta ad anello, 3 mm Ø

R494-030110-31

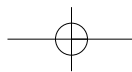

HADEO
INSTRUMENTE GERMANY

Hand-Instrumente
Hand instruments
Instrumentos manuales
Strumenti manuali



Hakensonde
Hook probe
Gancho explorador
Palpatore ad uncino
3,5 mm graduert / graduated / graduado
4 mm

R494-030110-03
R494-030110-04



Skalpellmesser
Scalpel knife
Cuchillo de bisturí
Coltello a bisturi

R494-030110-11



Hakenmesser
Hook knife
Cuchillo en forma de gancho
Coltello uncinato

R494-030110-12



Messer retrograd
Knife, retrograde
Cuchillo retrógrado
Coltello retrogrado

R494-030110-13

Banana-Messer
Banana knife
Cuchillo en forma de plátano
Coltello a banana



glatt / smooth / liso / liscio

R494-030110-14



gezahnt / serrated / dentado / dentellato

R494-030110-15



Rosettenmesser
Rosette knife
Cuchillo en forma de roseta
Coltello a rosetta

R494-030110-16

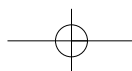

Magnetstab
Magnetic probe
Imán
Palpatore magnetico



Magnetstab stumpf, 5 mm Ø, 196 mm Nutzlänge
Magnetic probe blunt, 5 mm Ø, 196 mm working length
Imán romo, Ø 5 mm, largo útil de 196 mm
Palpatore magnetico smusso, Ø 5 mm, lunghezza lavorativa 196 mm

R490-050196-000



Wechsel- und Führungsstab 4 mm Ø, 250 mm lang
Switching rod and guide 4 mm Ø, 250 mm long
Varilla de introducción y cambio, 4 mm Ø, largo útil de 250 mm
Bastoncino di cambiamento e di guida, 4 mm Ø, lunghezza 250 mm

R490-040250-000

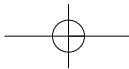

HADEO
INSTRUMENTE GERMANY

Monopolare Elektroden
Monopolar Electrodes
Electrodos monopolares
Elettrodi monopolari

Monopolare Elektroden, 3,5 mm Ø, 136 mm Nutzlänge
Monopolar Electrodes, 3,5 mm Ø, 136 mm working length
Electrodos monopolares, 3,5 mm Ø, largo útil de 136 mm
Elettrodi monopolari, 3,5 mm Ø, 136 mm lunghezza lavorativa

136 mm

Nadel 90° abgewinkelt
Needle angled 90°
Aguja acodada 90°
Ago curvo 90°

1,5 x 0,8

R460-035136-001



Nadel 90° abgewinkelt
Needle angled 90°
Aguja acodada 90°
Ago curvo 90°

4 x 0,8

R460-035136-004



Messer 45° gekröpft
Knife angled 45°
Cuchillo acodado 45°
Coltello curvo 45°

1,5 x 0,8

R460-035136-021



Nadel 45° gekröpft
Needle angled 45°
Aguja acodado 45°
Ago curvo 45°

3,5 x 0,8

R460-035136-031



Tastelektrode 90° abgewinkelt
Palpation electrode angled 90°
Electrodo de palpación, acodado 90°
Elettrodo palpatore, curva 90°

3 x 1,5

R460-035136-013

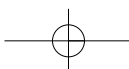

Spülkanüle
 Irrigation cannula
 Cánula de irrigación
 Cannula d'irrigazione



Spülkanüle mit 2 seitlichen Löchern, LL-Anschluß, 4,5 mm Ø, 8,3 cm
 Irrigation cannula with 2 holes, LL-connection, 4.5 mm Ø, 8.3 cm
 Cánula de irrigación con dos perforaciones laterales, conexión LL, 4,5 mm Ø, 8,3 cm
 Cannula d'irrigazione con 2 fori laterali, attacco LL, 4,5 mm Ø, 8,3 cm

R470-045083-000



scharfer Obturator
 sharp obturator
 obturador agudo
 otturatore acuto

R470-045083-001



stumpfer Obturator
 blunt obturator
 obturador romo
 otturatore smusso

R470-045083-002



Spüladapter mit Schlaucholive
 Irrigation adapter with tube connection
 Adaptador con conexión al tubo
 Adattatore dotato di attacco per tubi

R470-045000-000

Spülkanüle
 Irrigation cannula
 Cánula de irrigación
 Cannula d'irrigazione



3,2 mm Ø

4,5 mm Ø

Kanüle für Spülung mit Hahn, LL-Anschluß, 7 cm lang
 Cannula for irrigation with stop cock LL-connection, 7 cm length
 Cánula de irrigación con llave, conexión LL, largo útil de 7 cm
 Cannula d'irrigazione con rubinetto, attacco LL, lunghezza 7 cm

R471-032070-000

R471-045070-000



scharfer Obturator
 sharp obturator
 obturador agudo
 otturatore acuto

R471-032070-024

R471-045070-024



stumpfer Obturator
 blunt obturator
 obturador romo
 otturatore smusso

R471-032070-003

R471-045070-003

Spülsatz, komplett
 Aspiration cannula complete
 Cánula de irrigación completa
 Cannula d'irrigazione completa di trocar e otturatore

R471-032070-199

R471-045070-199



Kanüle für Spülung, LL-Anschluß, 3,2 mm Ø, 7 cm lang
 Cannula for irrigation, LL-connection, 3,2 mm Ø, 7 cm length
 Cánula de irrigación, conexión LL, 3,2 mm Ø, largo útil de 7 cm
 Cannula d'irrigazione, attacco LL 3,2 mm Ø, lunghezza 7 cm

R472-032070-000

Endoskope für Arthroskopie
 Endoscopes for Arthroscopy
 Endoscopios para artroscopía
 Ottiche per artroscopia

Ø 1,9 mm

Arthroskop, autoklavierbar mit integrierter Faser zur Beleuchtung für diagnostische und operative Eingriffe:
 kleine Gelenke

Arthroscope, autoclavable, with integrated fiber optic for illumination, for diagnostic and operation:
 small joint

Artroscopios (ópticas) autoclavables con fibroptica incorporado para intervenciones diagnósticas y operativas:
 articulaciones pequeñas

Ottiche autoclavabili con fibre ottiche per interventi diagnostici e operativi:
 Piccole articolazioni

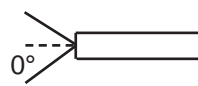
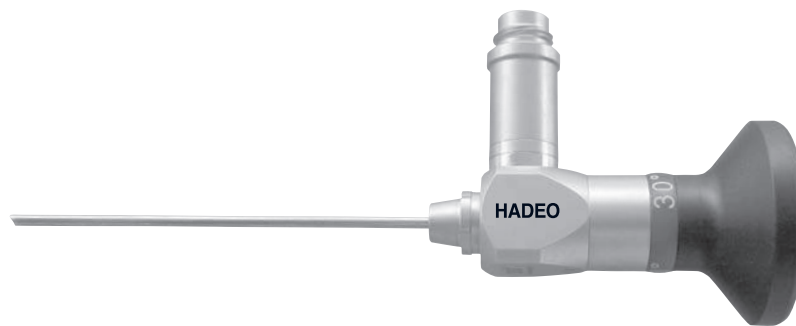

Geradeausblick
 Direct vision
 Vision directa
 Visione diretta angolo di

69 mm

R400-019069-000

102 mm

R400-019102-000

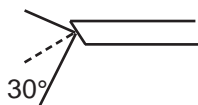

Vorausblick
 Foroblique vision
 ángulo de
 Visione grandangolo, angolo di

R400-0190069-030

R400-019102-030

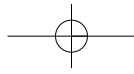

Trokarhülsen für Endoskope mit Ø 1,9 mm
 Trocar sleeves for endoscopes with Ø 1.9 mm
 Tubos para endoscopios de Ø 1,9 mm
 Camicie per artroscopia, ottiche di Ø 1,9 mm

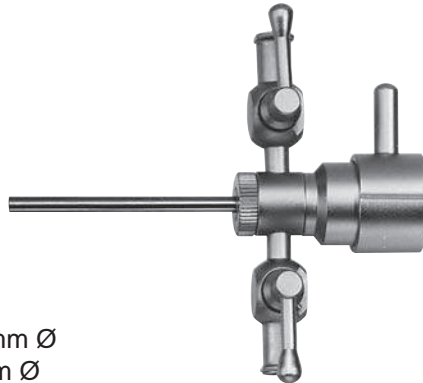

Trokar-Hülse mit zwei Spülhähnen, drehbar, 1,9 mm Ø
 Trocar sleeve, with two stop cocks rotating, 1.9mm Ø
 Tubo con dos llaves giratorias, de 1,9 mm Ø
 Camicia per trocar, con due rubinetti d'irrigazione rotativi, 1,9 mm Ø

	0°	30°
69 mm	R414-019069-000	R414-019069-030
102 mm	R413-019102-000	R413-019102-030

Obturator 1,9 mm Ø
 Obturator 1.9 mm Ø
 Obturador de 1,9 mm Ø
 Otturatore 1,9 mm Ø

scharf / sharp / agudo / punta trequarti



69 mm	R410-019069-001
102 mm	R410-019102-001

konisch stumpf / conical blunt / cónico romo / punta conica smussa



69 mm	R410-019069-002
102 mm	R410-019102-002

stumpf / blunt / romo / punta cilindrica smussa



69 mm	R410-019069-003
102 mm	R410-019102-003

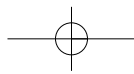

Instrumente für 2. Einstich
Instruments for 2nd puncture
Instrumentos para la segunda perforación
Strumenti per secondo ingresso

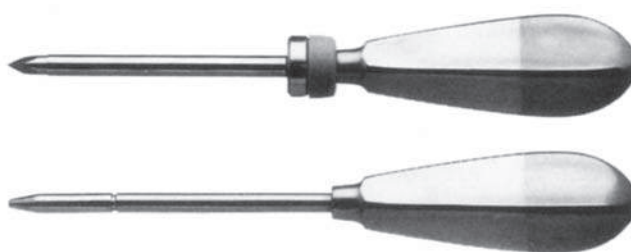

Trokarhülle mit scharfem und stumpfem Obturator, 2,5 mm Ø
Trocar sleeve with sharp and blunt obturator, 2.5 mm Ø
Tubo con obturadores agudos y romos, 2,5 mm Ø
Camicia con otturatore acuto e smusso, 2,5 mm Ø

R490-025110-43

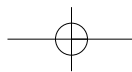

HADEO
INSTRUMENTE GERMANY

Instrumente für 2. Einstich
Instruments for 2nd puncture
Instrumentos para la segunda perforación
Strumenti per secondo ingresso

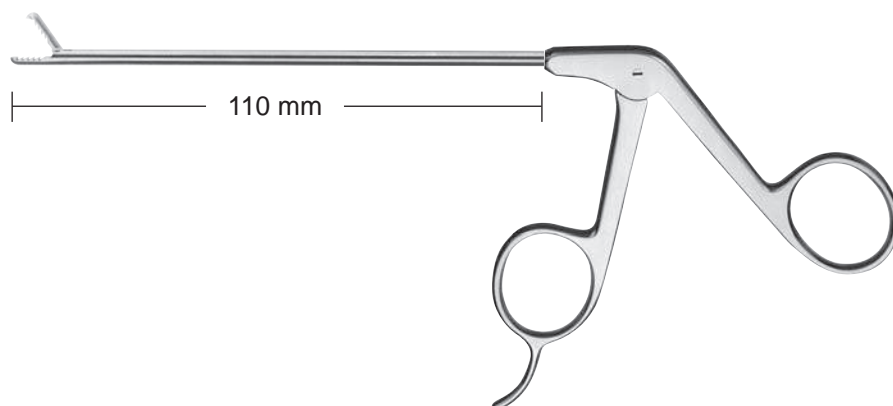

Zange mit Doppellöfel, 2 mm Ø
Forceps with double spoon, 2 mm Ø
Pinza con cucharilla doble, 2 mm Ø
Pinza con cucchiaio doppio, 2 mm Ø

R480-020110-000



Zange durchschneidend, 2 mm Ø
Forceps cutting through, 2 mm Ø
Pinza cortante, 2 mm Ø
Pinza tagliente, 2 mm Ø

R481-020110-000



Schere, 2 mm Ø
Scissors, 2 mm Ø
Tijera, 2 mm Ø
Forbice retta, 2 mm Ø

R485-020110-000



Faß-Biopsie-Zange, 2 mm Ø
Grasping and biopsy forceps, 2 mm Ø
Pinza de agarre y biopsia, 2 mm Ø
Pinza da presa e per biopsia, 2 mm Ø

R486-020110-000



Greif-Zange, 2 mm Ø
Grasping Forceps, 2 mm Ø
Pinza de agarre, 2 mm Ø
Pinza da presa, morso robusto a coccodrillo, 2 mm Ø

R487-020110-000

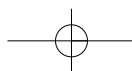

Endoskop Ersatzteile und Zubehör
Endoscope Spare Parts and Accessories
Piezas de repuesto y Accesorios para Artroscopia
Pezzo di ricambio e accessori per artroscopia

Farbcode für Blickrichtung:
Colour coding for indication of direction of view:
Indicación a color para definir la dirección de la vista:
Codice a colore per indicare la direzione di vista:
grün / green / verde / verde = 0°
rot / red / rojo / rosso = 30°
orange / orange / naranja / arancione = 45°
gelb / yellow / amarillo / giallo = 70°

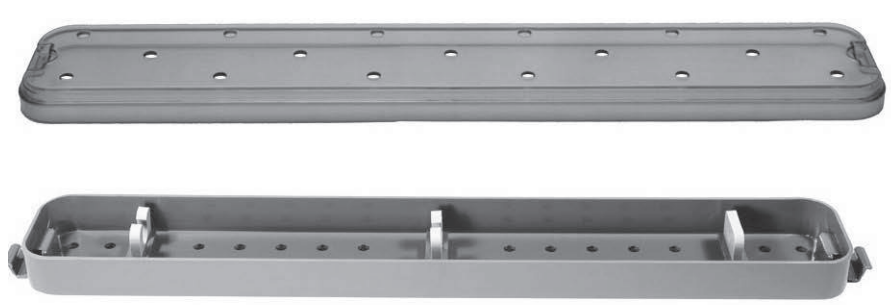
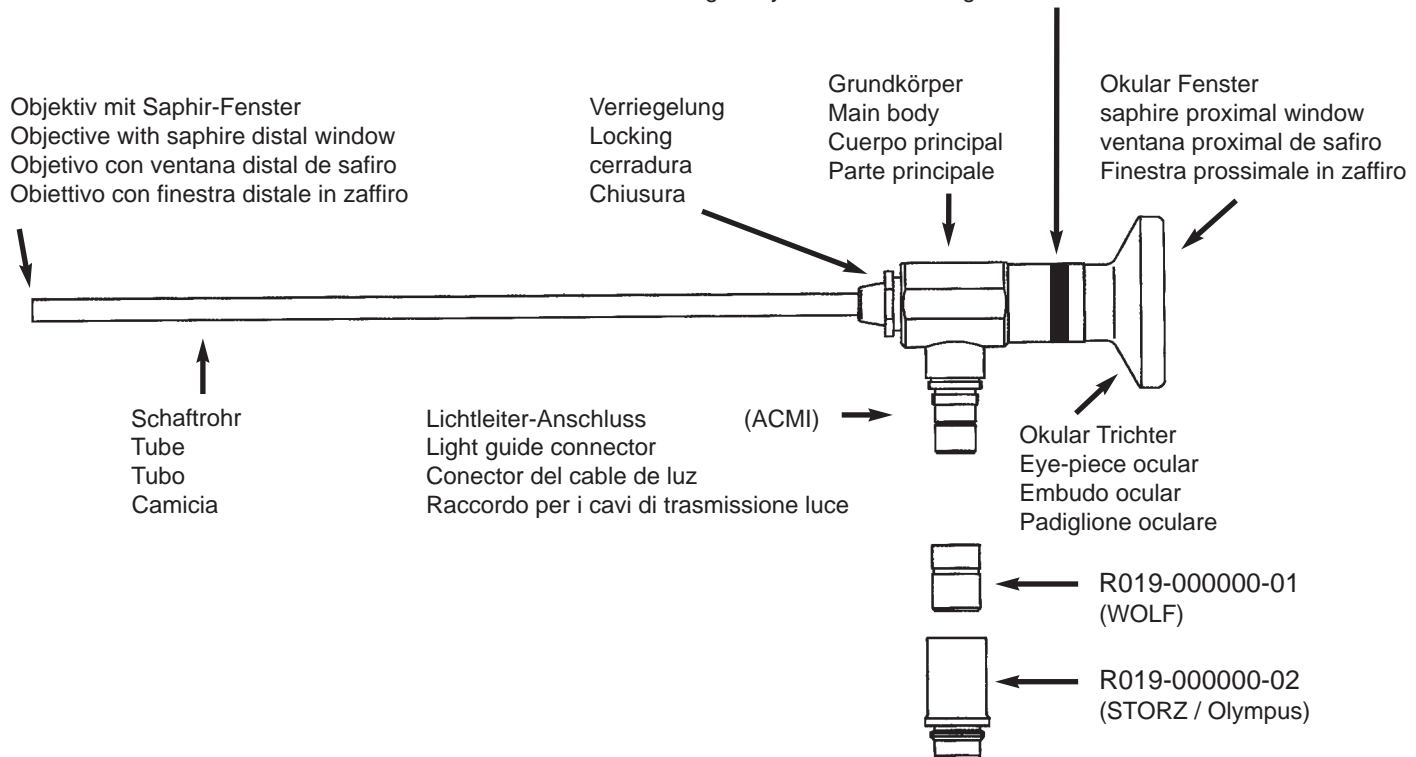

Scope Pak klein für Arthroskop
Scope pak small for one Arthroscope
Caja pequeña para Artroscopio
Contentitore piccolo per artroscopi

R019-9312

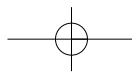

HADEO
INSTRUMENTE GERMANY

Zubehör
Accessoris
Accesorios
Accessori



Antibeslagmittel Ultra Stop 25 ml unsteril in Pipettenflasche
Anti Fog liquid Ultra Stop 25 ml non sterile
Agente antivano ultra stop 25 ml, no esteril en frasco de pipeta
Prodotto antiappannamento ultra-stop, 25 ml, flacone a pipetta, non sterile

R019-000000-025

Antibeslagmittel Ultra Stop steril 30 ml in Einstichflasche
Anti Fog liquid Ultra Stop sterile incision bottle 30 ml
Agente antivano ultra stop, esteril 30 ml en frasco de pinchazo
Prodotto antiappannamento ultra-stop, 30 ml, flacone perfosabile, sterile

R019-000000-030



Reinigungsmittel, Tube mit 6gr. f. distale u. proximale Linsen u. Fiberglas-Flächen von Endoskopen
Cleaning waste, 6gr. f. distal and proximal windows and fiber optic port of endoscopes
Agente de limpieza, tubo con 6gr para ventanas y optical distales y proximales
Prodotto per la pulizia delle ottiche distale e prossimale, tubo con 6gr

98002-06

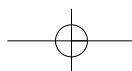

Container Typen und Dimensionen
Container models and dimensions
Modelos de contenedores y medidas
Modelli dei container e dimensioni

285 x 280 x 200 mm



Deckel gelocht
Boden ungelocht
Perforated lid
Unperforated bottom
Tapa perforada
Cuerpo sin perforación
Coperchio con filtro
Fondo senza filtro



Deckel gelocht
Boden gelocht
Perforated lid
Perforated bottom
Tapa perforada
Cuerpo perforado
Coperchio con filtro
Fondo con filtro



Sicherheitsdeckel
Boden ungelocht
Safety lid
Unperforated bottom
Tapa de seguridad
Cuerpo sin perforación
Coperchio di protezione
Fondo senza filtro



Sicherheitsdeckel
Boden gelocht
Safety lid
Perforated bottom
Tapa de seguridad
Cuerpo perforado
Coperchio di protezione
Fondo con filtro



silber
gelb
rot
blau
grün

R 310.20
R 320.20
R 330.20
R 340.20
R 350.20

R 311.20
R 321.20
R 331.20
R 341.20
R 351.20

R 312.20
R 322.20
R 332.20
R 342.20
R 352.20

R 313.20
R 323.20
R 333.20
R 343.20
R 353.20

Lagerungs- und Sterilisierack
Storage- and sterilization rack
Soporto para almacenaje y esterilizacion
Alloggio strumenti

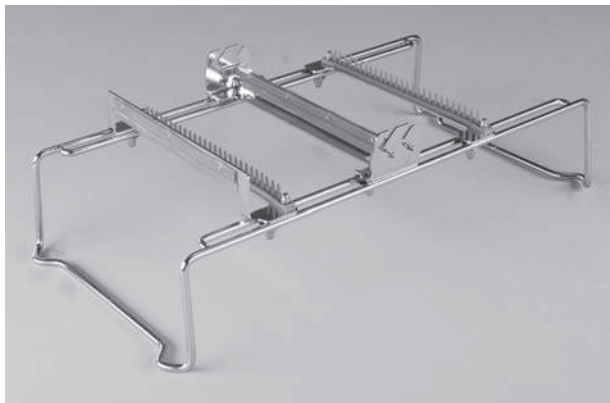

89258-25
232 x 210 x 155 mm

für Arthroskopie Instrumente
for arthroscopy instruments
para instrumentos de artroscopia
per strumenti artroscopici

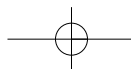

Index ART - Arthroskopie
Index ART - Arthroscopy

HADEO
INSTRUMENTE GERMANY

INDEX DEUTSCH

A	
Antrum-Stanzen23
Arthroskope Ø 4 mm2
Arthroskopie Ø 1,9 mm46
Arthroskopie Ø 2,7 mm4 / 6 / 8
B	
Biopsie-Stanze, seitlich schneidend24
Biopsie-Zange33
C	
Container Typen und Dimensionen52
E	
Endoskop Ersatzteile und Zubehör50
F	
Faden Zangen35
Faßzangen32
Faßzangen33
H	
Hakenschere30
Hakenstanze, mit Schippe12 - 15
Hand-Instrumente36
I	
Instrumente für 2. Einstich48
M	
Magnetstab42
Mikro-Scheren Stanze21
Monopolare Elektroden43
R	
Rotationszange26
S	
Saug- / Spülhandgriff pistolenförmig10
Saugstanze29
Schere gezahnt31
Spülkanüle44
Stanze oval22
Stanze, gezahnt16
Stanze, gezahnt "Duck" Form17
Stanze, gezahnt, breit19
Stanze, gezahnt, extra breit20
Stanze, gezahnt, lang18
T	
Trokarhülsen Ø 2,7 mm5 / 7 / 9
Trokarhülsen Ø 4 mm3
Trokarhülsen Ø 1,9 mm47
U	
Überlastschutz11

INDEX ENGLISH

A	
Antrum Punches23
Arthroscope Ø 4 mm2
Arthroscopy Ø 1,9 mm46
Arthroscopy Ø 2,7 mm4 / 6 / 8
B	
Biopsy forceps33
Biopsy punch, side-biter24
C	
Container models and dimensions52
E	
Endoscope Spare Parts and Accessoris50
G	
Grasper32
Grasping forceps34
H	
Hand instruments36
Hook punch, blunt nose12 - 15
Hook scissors30
I	
Instruments for 2nd puncture48
Irrigation cannula44
L	
Ligature forceps35
M	
Magnetic probe42
Monopolar Electrodes43
O	
Oval Punch22
Overload protection11
P	
Punch, serrated16
Punch, serrated, "Duck" shaped17
Punch, serrated, extra wide20
Punch, serrated, long18
Punch, serrated, wide19
R	
Rotary punch26
S	
Scissors serrated31
Slender Punch21
Suction / Irrigation handle pistol style10
Suction punch29
T	
Trocar sleeves Ø 2.7 mm5 / 7 / 9
Trocar sleeves Ø 4 mm3
Trocar sleeves Ø 1.9 mm47

INDICE ESPAÑOL

A	
Artroscopios Ø 4 mm	2
Aspiración / irrigación manejo a pistola	10
Artroscopia Ø 1,9 mm	46
Artroscopia Ø 2,7 mm	4 / 6 / 8
C	
Cánula de irrigación	44
E	
Electrodos monopolares	43
I	
Imán	42
Instrumentos manuales	36
Instrumentos para la segunda perforación	48
M	
Micro pinza cortante	21
Modelos de contenedores y medidas	52
P	
Piezas de repuesto y Accesorios para Artroscopia	50
Pinza cortante aserrada	16
Pinza cortante, aserrada, adicional ancho	20
Pinza cortante, aserrada, ancho	19
Pinza cortante, aserrada, pico de pato	17
Pinza cortante, de nariz aguda	12 - 15
Pinza cortante, largo	18
Pinza de biopsia	33
Pinza de succión	29
Pinza oval	22
Pinza para biopsia rotatoria	26
Pinza para biopsia, corte lateral	24
Pinzas	34
Pinzas antrum	23
Pinzas de agarre par	32
Pinzas para ligadura	35
Protección de sobrecarga	11
T	
Tijera dentada	31
Tijera en forma de gancho	30
Tubos para de Ø 1,9 mm	47
Tubos para endoscopios de Ø 2,7 mm	5 / 7 / 9
Tubos para endoscopios de Ø 4 mm	3

INDICE ITALIANO

A	
Artroscopes Ø 4 mm	2
Artroscopia Ø 1,9 mm	46
Artroscopia Ø 2,7 mm	4 / 6 / 8
C	
Camicie ottiche di Ø 1,9 mm	47
Camicie Ø 2,7 mm	5 / 7 / 9
Camicie per artroscopia, ottiche di Ø 4 mm	3
Cannula d'irrigazione	44
E	
Elettrodi monopolari	43
F	
Forbice uncinata	30
Forbici dentellate	31
I	
Impugnatura a pistola	10
M	
Micropinza Basket	21
Modelli dei container e dimensioni	52
P	
Palpatore magnetico	42
Pezzo di ricambio e accessori per artroscopia	50
Pinza d'aspirazione	29
Pinza da biopsia	33
Pinza dentellata	16
Pinza dentellata, largo	19
Pinza dentellata, lungo	18
Pinza dentellata, morso con paletta	17
Pinza dentellata, speciale largo	20
Pinza oval	22
Pinza per biopsia, taglio laterale	24
Pinza rotante	26
Pinza uncinata, morso con paletta	12-15
Pinze	34
Pinze antrum	23
Pinze da presa	32
Pinze per legatura	35
Protezione contro sovraccarico	11
S	
Strumenti manuali	36
Strumenti per secondo ingresso	48

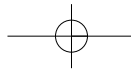

Nummernverzeichnis
Numerical Index
Indice numérico
Indice numerico

HADEO
INSTRUMENTE GERMANY

R400-019069-000	.46	R431-034130-000	.32	R440-035130-000	.12
R400-019069-030	.46	R431-045130-000	.32	R440-035130-000 S	.12
R400-019102-000	.46	R432-028130-000	.32	R440-035130-030	.12
R400-019102-030	.46	R432-034130-000	.32	R440-035130-030 S	.12
R400-027110-000	.4	R433-028130-000	.32	R440-035130-130	.12
R400-027110-030	.4	R433-034130-000	.32	R440-035130-130 S	.12
R400-027110-070	.4	R434-028130-000	.32	R441-028130-000	.14
R400-027175-000	.6	R434-034130-000	.32	R441-028130-007	.14
R400-027175-030	.6	R435-028130-000	.32	R441-028130-015	.14
R400-027175-070	.6	R435-034130-000	.32	R441-028130-030	.14
R400-027188-000	.8	R436-028130-000	.33	R441-028130-045	.14
R400-027188-030	.8	R436-028130-001	.33	R441-028130-107	.14
R400-027188-070	.8	R436-034130-000	.33	R441-028130-115	.14
R400-040175-000	.2	R436-034130-001	.33	R441-028130-130	.14
R400-040175-030	.2	R436-042150-210	.34	R441-028130-145	.14
R400-040175-045	.2	R436-042150-310	.34	R441-028130-200	.17
R400-040175-070	.2	R436-042150-410	.34	R441-028130-207	.17
R410-019069-001	.47	R437-022130-000	.34	R441-028130-215	.17
R410-019069-002	.47	R438-035130-000	.34	R441-028130-230	.17
R410-019069-003	.47	R439-034130-000	.35	R441-028130-245	.17
R410-019102-001	.47	R439-034130-015	.35	R441-028130-307	.17
R410-019102-002	.47	R439-034130-045	.35	R441-028130-315	.17
R410-019102-003	.47	R439-034130-100	.35	R441-028130-330	.17
R410-027110-001	.5	R439-034130-115	.35	R441-028130-345	.17
R410-027110-002	.5	R439-034130-145	.35	R441-028130-400	.15
R410-027110-003	.5	R439-034130-200	.35	R441-028130-407	.15
R410-027175-001	.7	R439-034130-300	.35	R441-028130-415	.15
R410-027175-002	.7	R439-034130-310	.35	R441-028130-430	.15
R410-027175-003	.7	R440-028130-000	.12	R441-028130-445	.15
R410-027188-001	.9	R440-028130-007	.12	R441-028130-607	.15
R410-027188-002	.9	R440-028130-015	.12	R441-028130-615	.15
R410-027188-003	.9	R440-028130-030	.12	R441-028130-630	.15
R410-040175-001	.3	R440-028130-045	.12	R441-028130-645	.15
R410-040175-002	.3	R440-028130-107	.12	R441-034130-000	.14
R410-040175-003	.3	R440-028130-115	.12	R441-034130-007	.14
R411-040175-030	.3	R440-028130-130	.12	R441-034130-015	.14
R411-040175-070	.3	R440-028130-145	.12	R441-034130-030	.14
R412-040175-030	.3	R440-028130-200	.13	R441-034130-045	.14
R412-040175-070	.3	R440-028130-207	.13	R441-034130-107	.14
R413-027110-030	.5	R440-028130-215	.13	R441-034130-115	.14
R413-027110-070	.5	R440-028130-230	.13	R441-034130-130	.14
R413-027175-030	.7	R440-028130-245	.13	R441-034130-145	.14
R413-027175-070	.7	R440-028130-307	.13	R441-034130-200	.17
R413-027188-030	.9	R440-028130-315	.13	R441-034130-207	.17
R413-027188-070	.9	R440-028130-330	.13	R441-034130-215	.17
R413-040175-030	.3	R440-028130-345	.13	R441-034130-230	.17
R413-040175-070	.3	R440-034130-000	.12	R441-034130-245	.17
R414-019069-030	.47	R440-034130-007	.12	R441-034130-307	.17
R414-019102-030	.47	R440-034130-015	.12	R441-034130-315	.17
R414-027110-030	.5	R440-034130-030	.12	R441-034130-330	.17
R414-027110-070	.5	R440-034130-045	.12	R441-034130-345	.17
R414-027175-030	.7	R440-034130-107	.12	R441-034130-400	.15
R414-027175-070	.7	R440-034130-115	.12	R441-034130-407	.15
R414-027188-030	.9	R440-034130-130	.12	R441-034130-415	.15
R414-027188-070	.9	R440-034130-145	.12	R441-034130-430	.15
R414-040175-030	.3	R440-034130-200	.13	R441-034130-445	.15
R414-040175-070	.3	R440-034130-207	.13	R441-034130-545	.24
R415-000000-002	.10	R440-034130-215	.13	R441-034130-590	.24
R415-000000-027	.10	R440-034130-230	.13	R441-034130-607	.15
R415-000000-040	.10	R440-034130-245	.13	R441-034130-615	.15
R415-027188-000	.10	R440-034130-307	.13	R441-034130-630	.15
R415-027188-030	.10	R440-034130-315	.13	R441-034130-645	.15
R415-040175-000	.10	R440-034130-330	.13	R441-034130-745	.24
R415-040175-030	.10	R440-034130-345	.13	R441-034130-790	.24
R430-028130-000	.32	R440-034130-545	.24	R442-028130-000	.16
R430-034130-000	.32	R440-034130-545 B	.24	R442-028130-007	.16
R430-045130-000	.32	R440-034130-590	.24	R442-028130-015	.16
R431-028130-000	.32	R440-034130-745	.24	R442-028130-030	.16
R431-028130-000 S	.32	R440-034130-790	.24	R442-028130-045	.16

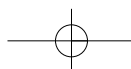

R442-028130-107	16	R444-034130-790	20	R470-045083-000	44
R442-028130-115	16	R446-034130-000	20	R470-045083-001	44
R442-028130-130	16	R446-034130-007	20	R470-045083-002	44
R442-028130-145	16	R446-034130-015	20	R471-032070-000	45
R442-034130-000	16	R446-034130-030	20	R471-032070-003	45
R442-034130-007	16	R446-034130-045	20	R471-032070-024	45
R442-034130-015	16	R446-034130-107	20	R471-032070-199	45
R442-034130-030	16	R446-034130-115	20	R471-045070-000	45
R442-034130-045	16	R446-034130-130	20	R471-045070-003	45
R442-034130-107	16	R446-034130-145	20	R471-045070-024	45
R442-034130-115	16	R446-034130-200	20	R471-045070-199	45
R442-034130-130	16	R446-034130-207	20	R472-032070-000	45
R442-034130-145	16	R446-034130-215	20	R480-020110-000	49
R443-034130-000	19	R446-034130-230	20	R481-020110-000	49
R443-034130-007	19	R446-034130-245	20	R485-020110-000	49
R443-034130-015	19	R446-034130-307	20	R486-020110-000	49
R443-034130-030	19	R446-034130-315	20	R487-020110-000	49
R443-034130-045	19	R446-034130-330	20	R490-025110-43	48
R443-034130-107	19	R446-034130-345	20	R490-030110-03	36
R443-034130-115	19	R446-040110-01	28	R490-030110-05	36
R443-034130-130	19	R446-040110-02	28	R490-030110-11	36
R443-034130-145	19	R446-045130-00 A	29	R490-030110-12	36
R443-034130-200	19	R446-045130-00 I	29	R490-030110-13	36
R443-034130-207	19	R446-045130-00 R	29	R490-030110-14	36
R443-034130-215	19	R447-034130-000	21	R490-030110-15	36
R443-034130-230	19	R447-034130-007	21	R490-030110-16	36
R443-034130-245	19	R447-034130-015	21	R490-030110-17	37
R443-034130-307	19	R447-034130-030	21	R490-030110-21	37
R443-034130-315	19	R447-034130-045	21	R490-030110-31	37
R443-034130-330	19	R447-034130-107	21	R490-030110-32	37
R443-034130-345	19	R447-034130-115	21	R490-030110-43	37
R443-034130-507	25	R447-034130-130	21	R490-030110-45	37
R443-034130-515	25	R447-034130-145	21	R490-030110-47	37
R443-034130-530	25	R448-034130-000	22	R490-030110-51	37
R443-034130-545	25	R448-034130-015	22	R490-040250-000	42
R443-034130-590	25	R448-034130-045	22	R490-050196-000	42
R443-034130-607	25	R448-034130-145	22	R492-000000-000	38
R443-034130-615	25	R448-034130-200	22	R492-030110-00	39
R443-034130-630	25	R448-035130-000	23	R492-030110-03	39
R443-034130-645	25	R448-035130-600	23	R492-030110-04	39
R443-034130-707	25	R448-035130-800	23	R492-030110-11	39
R443-034130-715	25	R448-035130-900	23	R492-030110-12	39
R443-034130-730	25	R449-035100-090	27	R492-030110-13	39
R443-034130-745	25	R449-035100-090 C	26	R492-030110-14	39
R443-034130-790	25	R449-035100-190	27	R492-030110-15	39
R443-034130-807	25	R449-035100-190 C	26	R492-030110-16	39
R443-034130-815	25	R450-028130-000	30	R492-030110-17	38
R443-034130-830	25	R450-028130-030	30	R492-030110-21	38
R443-034130-845	25	R450-028130-045	30	R492-030110-31	38
R444-034130-000	18	R450-028130-130	30	R492-030110-32	38
R444-034130-007	18	R450-028130-145	30	R492-030110-43	38
R444-034130-015	18	R450-034130-000	30	R492-030110-45	38
R444-034130-030	18	R450-034130-030	30	R492-030110-47	38
R444-034130-045	18	R450-034130-045	30	R492-030110-51	38
R444-034130-107	18	R450-034130-130	30	R494-030110-03	41
R444-034130-115	18	R450-034130-145	30	R494-030110-04	41
R444-034130-130	18	R450-034130-245	30	R494-030110-11	41
R444-034130-145	18	R450-034130-345	30	R494-030110-12	41
R444-034130-200	18	R451-034130-000	31	R494-030110-13	41
R444-034130-207	18	R451-034130-030	31	R494-030110-14	41
R444-034130-215	18	R451-034130-045	31	R494-030110-15	41
R444-034130-230	18	R451-034130-130	31	R494-030110-16	41
R444-034130-245	18	R451-034130-145	31	R494-030110-17	40
R444-034130-307	18	R460-035136-001	43	R494-030110-21	40
R444-034130-315	18	R460-035136-004	43	R494-030110-31	40
R444-034130-330	18	R460-035136-013	43	R494-030110-43	40
R444-034130-345	18	R460-035136-021	43	R494-030110-45	40
R444-034130-445	23	R460-035136-031	43		
R444-034130-590	20	R470-045000-000	44		

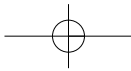

HADEO
INSTRUMENTE GERMANY

