

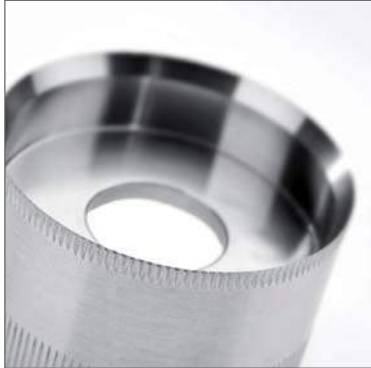

Plastische Chirurgie
Plastic Surgery
Cirugía Plástica
Chirurgia Plastica



HADEO
INSTRUMENTE GERMANY





Wondershare PDFelement



Hadeo instrumente



HADEO

INSTRUMENTE GERMANY

Charrière (Ch) French (F)	Durchmesser in mm	Inches	Gauge (G)	Durchmesser in mm	Inches
1	0,33	0,013	35	0,13	0,005
2	0,67	0,025	34	0,18	0,007
3	1,00	0,039	33	0,20	0,008
4	1,33	0,051	32	0,23	0,009
5	1,67	0,065	31	0,25	0,010
6	2,00	0,0787	30	0,30	0,012
7	2,33	0,092	29	0,33	0,013
8	2,67	0,105	28	0,36	0,014
9	3,00	0,1181	27	0,41	0,016
10	3,33	0,131	26	0,46	0,018
11	3,67	0,144	25	0,51	0,020
12	4,00	0,1575		0,53	0,021
13	4,33	0,170	24	0,56	0,022
14	4,67	0,184	23	0,64	0,025
15	5,00	0,1968	22	0,71	0,028
16	5,33	0,210	21	0,81	0,032
17	5,67	0,223	20	0,89	0,035
18	6,00	0,2362		0,97	0,038
19	6,33	0,249	19	1,07	0,042
20	6,67	0,263	18	1,27	0,050
21	7,00	0,2756	17	1,50	0,059
22	7,33	0,288	16	1,65	0,065
23	7,67	0,302	15	1,83	0,072
24	8,00	0,3150	14	2,11	0,083
25	8,33	0,328	13	2,41	0,095
26	8,67	0,341	12	2,77	0,109
27	9,00	0,3543	11	3,05	0,120
28	9,33	0,367	10	3,40	0,134
29	9,67	0,380	9	3,76	0,148
30	10,00	0,3973	8	4,19	0,165
31	10,33	0,407	7	4,57	0,180
32	10,67	0,420	6	5,16	0,203
34	11,33	0,446			
36	12,00	0,4724			
38	12,67	0,494			
40	13,33	0,5199			
45	15,00	0,5905			

1 OZ	0,028 ml	35 OZ	1,0 l
5 OZ	0,140 ml	128 OZ	3,7 l
16 OZ	0,450 ml		

HADEO
INSTRUMENTE GERMANY**GARANTIE / WARRANTY / GARANTIA / GARANZIA****GARANTIE**

Wir gewähren auf alle Hadeo Instrumente 3 Jahre Garantie. Voraussetzung ist der sach- und fachgerechte Einsatz der Instrumente.
Von der Garantie sind Verschleißerscheinungen ausgeschlossen.

WARRANTY

Our Hadeo products are free from manufacturing defects in material and workmanship. We therefore give on all instruments a guarantee of 3 years provided that the instruments are maintained and cleaned properly and used normally for their intended purpose.

GARANTIA

Estamos convencidos de nuestra calidad y concedemos a todos los instrumentos de Hadeo 3 años de garantía contra cualquier defecto de fabricación, siempre y cuando se usen adecuadamente. De la garantía excluimos la manifestación de desgaste.

GARANZIA

Siamo convinti della nostra qualità e concediamo 3 anni di garanzia sulla funzione dei tutti gli strumenti Hadeo sotto la presupposizione che l'utilizzo è da esperto.
Escluso della garanzia sono tracce di consumo.



HADEO Ltda. wurde im Jahr 1978 in Bogotá, Kolumbien, gegründet. Ziel der Firmengründung war der Vertrieb von chirurgischen Instrumenten.

In den 35 Jahren ihres Bestehens hat sich die Firma HADEO zu einem bekannten und zuverlässigen Partner der Ärzteschaft in Kolumbien entwickelt. Sie stellt ihren Kunden Instrumente von hoher Qualität zur Verfügung, und sieht ihre Aufgabe darin, die Erwartungen ihrer Kunden stets zu erfüllen. Aus diesem Grunde bietet die Firma HADEO Dienstleistungen und Produkte von hoher Qualität.

Motivierte Mitarbeiter tragen mit ihrer Selbständigkeit und ihrem persönlichen Engagement wesentlich zum Erfolg der Firma bei, was eine positive Auswirkung auf die Geschäftsbeziehung zu unseren Kunden hat.

HADEO vertreibt chirurgische Instrumente in den Bereichen:

- Allgemein- und Viszeralchirurgie
- Gefäß-, Mikro- und Neurochirurgie
- Herz- und Thoraxchirurgie
- Gynäkologie und Urologie
- HNO, Ophthalmologie
- Orthopädie
- Plastische Chirurgie
- Laparoskopie
- Endo- Neurochirurgie
- Arthroskopie
- Sinuskopie
- Cytoskopie
- Hysteroskopie

Die Firma HADEO bietet eine hohe Lieferbereitschaft und Flexibilität mit der Absicht die volle Zufriedenheit ihrer Kunden zu gewährleisten.

HADEO Limitada fue fundada en el año de 1978 en Bogotá, Colombia, con el propósito de distribuir instrumentos quirúrgicos de la más alta calidad.

Durante los más de 35 años de su existencia la empresa HADEO se ha convertido en un proveedor bien conocido y responsable para el cuerpo médico en el país. Ofrece instrumental de primera calidad y presta sus servicios con el fin de cumplir en la mejor forma las expectativas de sus clientes. Nuestro equipo de trabajo contribuye al éxito de la empresa con su compromiso y su entusiasmo, lo cual incrementa una relación favorable con la clientela.

Nuestras especialidades en cirugía incluyen instrumentos para:

- Cirugía general y visceral
- Cirugía vascular, micro cirugía, neurocirugía
- Cirugía cardiovascular
- Ginecología y urología
- ORL, oftalmología
- Ortopedia
- Cirugía plástica
- Laparoscopia
- Endo-neurocirugía
- Artroscopia
- Sinuscopia
- Cistoscopia
- histeroscopia

HADEO LTDA dispone de un surtido stock lo cual nos permite despachar con prontitud y flexibilidad con el fin de lograr la mayor satisfacción de nuestros clientes.

IMPORTANT INFORMATION CONCERNING PREPARING AND STERILIZING SURGICAL INSTRUMENTS

Dear Sirs,
please read the following instructions very carefully before using the instruments.

1. INITIAL USE

All instruments which are being used for the first time must be thoroughly cleaned, rinsed and then sterilized before using.

2. TREATING INSTRUMENTS AFTER USAGE

- a.) The instruments might be immediately thoroughly cleaned and disinfected. Please follow the manufacturer's instructions when using cleaning agents and disinfectants.
- b.) Instruments which may be dismantled must be cleaned and disinfected after being taken apart.
- c.) Cleaning may be carried out either manually or with a machine. Care should be taken that only cleaning agents and disinfectants are used, which are changed daily.
- d.) Following chemical disinfection and manual cleaning, all instruments must always be thoroughly rinsed under running water.
- e.) The temperature of water used in a machine for cleaning should not exceed 45°C.
- f.) Whether cleaning is carried out manually or by machine, we especially ask you to ensure that the correct dosage for cleaning solutions or the correct combination of disinfectant and cleaning solution, is employed. Similar importance should be applied to the length of time the agents require to perform properly and to the temperature set.
- g.) Hinged instruments should be opened before cleaning.
- h.) Please ensure that the perforated instrument trays, when loaded, do not exceed 10 kg in weight.
- i.) Please take care that when instruments are being cleaned they are arranged proper in a manne that fluids can circulate freely.
- j.) Deposits remaining after the cleaning process must be completely removed in the first rinse which now follows. The optimum temperature for final rinsing has proved to be between 70° and 90° C. Please use only purified water in this final cleaning stage.
- k.) The instruments must be carefully dried after cleaning and rinsing is completed.
- l.) Moving parts and the cutting edges of shears and scissors must be treated with preservatives which are both suitable and physiologically safe.

3. TESTING FOR CORRECT FUNCTIONING

- a.) Instruments must be carefully and thoroughly checked before every occasion that they are used.

- b.) After each time they are cleaned, the instruments must be macroscopically clean, i.e., visibly free from proteinbased residues and other soiling.
- c.) Care should be taken so that cracks, breakages and corrosion are noticed.
- d.) Instruments with flecks should be separated and taken out for special treatment.
- e.) All moving parts as well as working tips and blades should be checked with special care.
- f.) Checking should be carried out according to the extent to which the instruments will be used.
- g.) Instruments which are in any way defective or damaged should be immediately sorted out from the others.

4. STERILIZATION

- a.) All stainless steel surgical instruments supplied by us may be sterilized in an autoclave.
- b.) Please follow the manufacturer's operating instructions when using autoclave. All machines used must comply with all current quality and other standards.
- c.) Instruments are being sterilized/ autoclaved at a temperature of 134°C.
- d.) Sterilization packing material must comply with all current standards.
- e.) Instruments with ratchets or self-retaining mechanisms should be sterilized opened or in the first ratchet position.
- f.) Please ensure that perforated instrument trays, when loaded do not exceed 10 kg in weight.

5. IN GENERAL

- a.) All surgical instruments supplied by us have been thoroughly inspected before dispatch and leave our factory in perfect condition. Damage which can arise as a result of transporting, cleaning, preserving, sterilizing or storing, must be prevented.
- b.) Please handle surgical instruments always with the utmost care.
- c.) Instruments must be stored in a clean and dry place.
- d.) If you have any queries or problems please contact us at any time:

We should like to point out that, if the above-mentioned directions are not followed or the instruments supplied by us are not properly used, all guarantee claims become void and any consequences must be borne by yourselves.

SUGERENCIAS PARA LA LIMPIEZA, ESTERILIZACIÓN Y MANTENIMIENTO DE INSTRUMENTOS QUIRÚRGICOS

ENJUAGADO

Tras el uso enjuagar enseguida los instrumentos bajo un chorro de agua caliente (no hirviendo). El enjuagado debe servir para quitar los residuos de sangre, mucosas y tejidos.

LIMPIEZA

Si la limpieza no se efectúa inmediatamente después del enjuagado, los instrumentos tienen que sumergirse en una solución de agua y detergente con PH neutro (7)

Para los instrumentos muy delicados (algunos tipos de porta agujas o tijeras se aconseja una limpieza manual: ver punto "C".

a.- Limpieza en la pila de ultrasonido

Los instrumentos tienen que estar en la pila el tiempo necesario recomendado por el fabricante para efectuar el ciclo del lavado, generalmente de 5 a 10 minutos.

Los instrumentos con bisagras o juntas (articulaciones) tienen que sumergirse en la pileta en posición abierta.

Asegurarse de que las hojas afiladas de las tijeras, bisturíes para gingivectomía, curetas, etc. no estén en contacto con otros instrumentos.

Todos los instrumentos deben estar completamente sumergidos en la solución de lavado.

No poner instrumentos de diferentes metales (acero inoxidable, instrumentos cromados, latón, etc.) en el mismo ciclo de lavado.

Cambiar a menudo la solución para el lavado, como mínimo todas las veces que lo recomienda el fabricante de la pila de ultrasonidos.

Enjuagar concienzudamente los instrumentos con agua corriente tras lavado con ultrasonidos para quitar los residuos de la solución de lavado.

b.- Limpieza con lavadora

Seguir las indicaciones del fabricante. Asegurarse de que los instrumentos hayan sido lubricados tras el último ciclo de lavado y antes del ciclo de esterilización.

c.- Limpieza manual

La mayor parte de los fabricantes de instrumentos indican el lavado con los ultrasonidos como el modo mejor y más eficaz para limpiar los instrumentos quirúrgicos, especialmente los que tienen bisagras, cierres y en general articulaciones. Si la limpieza con los ultrasonidos no es posible, se aconseja usar el método siguiente:

- Usar cepillos rígidos de plástico, nylon, etc.
- Cepillar concienzudamente los instrumentos más delicados y, si es posible, enjuagar, limpiar y esterilizar estos instrumentos separadamente.
- Verificar que toda la superficie de estos instrumentos esté limpia.
- Tras haber cepillado los instrumentos, enjuagarlos bajo el chorro de agua corriente.
- Durante el enjuagado abrir y cerrar las tijeras, las pinzas hemostáticas, los porta agujas y los demás instrumentos con bisagras o juntas y asegurarse de que las partes internas de las bisagras estén perfectamente enjuagadas como la superficie externa del instrumento.

SECADO, LUBRIFICACIÓN E INSPECCIÓN

Tras las operaciones de limpieza y de enjuagado, los instrumentos quirúrgicos tienen que ser secados perfectamente.

Todos los instrumentos con juntas o bisagras (acción "metal contra metal") como tijeras, pinzas hemostáticas, porta agujas, fórceps de extracción, etc., tienen que ser lubricados. Se aconsejan lubricantes específicos para el instrumental quirúrgico. No usar aceites o lubricantes industriales.

A este punto es buena norma inspeccionar el estado de cada instrumento y verificar el funcionamiento según el uso específico. Controlar y asegurarse de que:

- Las hojas de las tijeras estén lisas de arriba abajo y de que, una vez cerradas, no hagan juego. Probar las tijeras cortando gasa muy fina. Tres cuartas parte de la hoja tienen que cortar la gasa sin retenerla.

- Las puntas de las pinzas estén al mismo nivel.
- Las pinzas hemostáticas y los porta agujas no dejen pasar la luz entre las puntas cuando estén cerradas, se abran y cierren fácilmente y que las bisagras no estén demasiado flojas.
- Controlar el desgaste de la porta agujas sobre la superficie interna de las puntas.
- Las cánulas metálicas de aspiración estén bien limpiadas en su interior.
- Los instrumentos cortantes y los bisturíes tengan las hojas bien afiladas y no estropeadas.

ESTERILIZACIÓN EN AUTOCLAVE

Tras haber enjuagado, limpiado, secado, lubricado e inspeccionado los instrumentos, éstos pueden ser preparados para la esterilización separadamente o en serie.

Instrumentos individuales:

Las bolsas especiales monouso son el ideal para contener los instrumentos. Asegurarse de que las bolsas que contendrán los instrumentos con cierres y articulaciones (pinzas hemostáticas, porta agujas, etc.) sean lo bastante grandes como para contener los citados instrumentos en posición abierta.

Instrumentos en serie:

Poner los instrumentos en los especiales cestos o bandejas de acero inoxidable. Poner los instrumentos más pesados en la parte inferior cuando sean necesarias varias bandejas.

No cerrará nunca los instrumentos durante el ciclo en autoclave, un instrumento cerrado no estará nunca bien esterilizado, ya que el vapor no puede penetrar en la parte de cierre a contacto "metal contra metal". En el instrumento podría además romperse en la parte de la bisagra a causa de la expansión del metal debida al calor durante el ciclo del autoclave.

No cargar demasiado la cámara del autoclave ya que algunos instrumentos podrían formar "zonas de sombra" sobre otros en los que el vapor no penetraría.

ATENCIÓN

Al final del ciclo de esterilización - antes del ciclo de secado - abrir ligeramente la portezuela del autoclave y preceder con el ciclo desecado según las instrucciones del fabricante. Si la portezuela del autoclave se abre completamente antes del ciclo de secado, el aire frío de la habitación entraría en la cámara del autoclave causando la formación de condensación sobre los instrumentos y de consecuencia aparecerían las manchas de agua que vemos a menudo en los mismos.

ESTERILIZACIÓN EN FRÍO:

La mayor parte de las soluciones para la esterilización en frío esterilizan los instrumentos completamente tras 10 horas de inmersión. Esta acción química prolongada puede ser más perjudicial para los instrumentos que el ciclo normal de 20 minutos en autoclave.

Si los instrumentos tienen necesidad de ser simplemente "desinfectados", el proceso en frío es adecuado, ya que la desinfección tiene lugar en 10 minutos solamente.

Recuerde bien la diferencia entre:

ESTÉRIL - término absoluto (ningún organismo logra sobrevivir) y

DESINFECTADO - perfectamente limpio.

Usen siempre la técnica más adecuada de esterilización/limpieza de los instrumentos según el uso que se haga posteriormente de ellos.

Recuerden que la esterilización de los instrumentos no sustituye la limpieza de los mismos.

Recomendamos no volver a usar ni esterilizar los artículos de un solo uso. Si se tratan en el modo correcto los instrumentos construidos con las modernas aleaciones inoxidables pueden durar muchos años.

**INDICAZIONI PER LA CURA, PULITURA E LA STERILIZZAZIONE
DELLO STRUMENTARIO CHIRURGICO RISTERILIZZABILE****Misure preventive anticorrosione**

- 1) Raggruppare accuratamente gli strumenti correttamente confezionati e sterilizzati prima dell'operazione; selezionarli secondo l'intervento. Verificare sempre che la confezione esterna sia integra e che lo strumento stesso non sia danneggiato.
 - 2) Assicurarsi tramite l'indicatore di sterilizzazione collocato all'interno del vaglio che il contenuto sia stato sterilizzato.
 - 3) Disporre gli strumenti seguendo l'ordine di utilizzo durante l'operazione; lasciare gli strumenti non necessari nel vaglio; predisporre gli strumenti solo immediatamente prima dell'operazione.
 - 4) Nel corso dell'operazione rimuovere dagli strumenti sangue ed altri materiali biologici; dopo l'uso, riporre gli strumenti nel corretto alloggiamento.
 - 5) Risciacquare opportunamente gli strumenti cavi, al fine di evitare l'adesione di sangue e polvere d'osso.
 - 6) Per la pulitura degli strumenti utilizzare una soluzione lattata o una soluzione salina, ma non immergerli nelle suddette soluzioni.
 - 7) Iniziare l'operazione di pulitura subito dopo l'intervento. Strumenti utilizzati su pazienti con possibili infezioni: smaltire in modo analogo, eliminando sangue, polvere d'osso parti di tessuto in eccesso.
 - 8) Pulire gli strumenti in un luogo previsto nell'ambito della sala operatoria.
- Nel caso in cui gli strumenti vadano collocati direttamente nella centrale di sterilizzazione, è necessario dapprima coprirli, per evitare il rischio di contaminazione ai danni del personale o dell'ambiente circostante.

Disinfezione

Durante l'uso di disinfettanti chimici è necessario osservare scrupolosamente le indicazioni del produttore; utilizzare le soluzioni sempre previa diluizione. Nella fase termica di disinfezione con acqua bollente assicurarsi che l'acqua sia priva di corpi estranei.

Pulitura

Indipendentemente dal metodo utilizzato per la pulitura (meccanico o manuale) si raccomanda di verificare attentamente quale detergente vada utilizzato con ciascun metodo. Valori pH consigliati: tra 7,0 e 8,5.

1) Pulitura meccanica

Osservare scrupolosamente le istruzioni d'uso fornite dal produttore della macchina pulitrice. Predisporre gli

strumenti per la pulitura meccanica. Tutti gli strumenti appuntiti e delicati dovrebbero essere puliti manualmente.

Non sovraccaricare i vagli, mettere gli strumenti pesanti sul fondo del vaglio. Se necessario, immergere e risciacquare gli strumenti molto sporchi (strumenti cavi), prima di collocarli nella lavatrice.

2) Pulitura ad ultrasuoni

(fa parte dei metodi di pulitura meccanica)

Prima di inserire uno strumento nel bagno ad ultrasuoni, rimuovere i materiali organici in eccesso. I bagni ad ultrasuoni sono consigliati per le filettatrici o gli strumenti con solchi profondi. L'ultrasuono deve essere seguito da un programma di risciacquo normale.

3) Pulitura manuale

Richiede diverse spazzole in nylon, una canna da soffio ed un ugello da soffio/ un dispositivo ad aria compressa pulito, detergenti e solventi come per la pulitura meccanica.

Per gli additivi di pulitura osservare le indicazioni fornite dal produttore.

Per la pulitura degli strumenti dotati di cannula, passare più volte lo spazzolino di nylon attraverso la cannula eseguendo movimenti rotatori (non utilizzare spazzole in lana d'acciaio/metallo) fino alla completa rimozione dei residui eliminabili con questo metodo.

Soffiare poi con aria compressa nella cannula.

4) Asciugatura

Ogni strumento deve essere asciugato completamente sia internamente che esternamente per evitare la formazione di ruggine o malfunzionamenti.

Indicazioni per la sterilizzazione della strumentazione

Pulire immediatamente ed asciugare bene gli strumenti usati, non utilizzare detergenti e disinfettanti con additivi fortemente acidi o alcalini (ad es. soda, soda caustica o acidi)!

Sterilizzare la strumentazione solo a vapore A 134°!

Prima della sterilizzazione, assicurarsi che gli strumenti siano perfettamente funzionanti ed integri. La sterilizzazione non sostituisce la pulitura.

HADEO
INSTRUMENTE GERMANY

Markierungs- und Messinstrumente
Marking and Measuring Instruments
Instrumentos para marcar y medir
Strumenti per marcare e misurare



Winkelmesser
Goniometer
Goniómetro
Goniometro

MOELTGEN
03312-01
24 cm, 9 1/2"

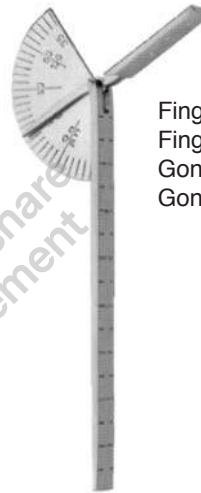

Finger-Goniometer
Finger goniometer
Goniómetro para dedos
Goniometro per le dita

03314-01
13 cm, 5 1/8"



03340-10	10 cm	4"
03340-15	15 cm	6"
03340-20	20 cm	8"
03340-30	30 cm	11 3/4"
03340-50	50 cm	19 3/4"

HADEO
INSTRUMENTE GERMANY

Markierungsinstrumente
Marking Instruments
Instrumentos para marcar
Strumenti per marcare

Facelift-Markierer
Facelift marker
Marcador para facelift
Marcatore per facelift



PITANGUY
03370-16
16 cm, 6¹/₄"

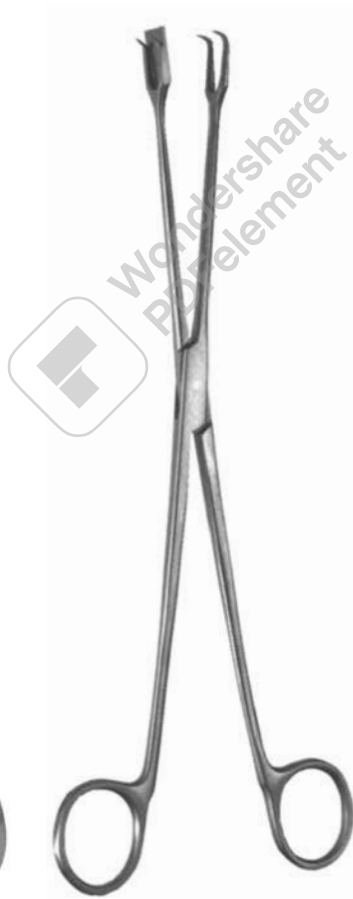

D'ASSUMPACO
03380-30
28 cm, 11"



LOCKWOOD
03390-30
32,5 cm, 12³/₄"

HADEO
INSTRUMENTE GERMANY

Markierungs- und Messinstrumente
Marking and Measuring Instruments
Instrumentos para marcar y medir
Strumenti per marcare e misurare



McKISSOCK
03400-38 38 mm, 1½"
03400-42 42 mm, 1⅔"
03400-45 45 mm, 1¾"



FREEMAN
03500-38 38 mm, 1½"
03500-42 42 mm, 1⅔"
03500-44 45 mm, 1¾"



CASTROVIEJO
43583-07 7 cm, 2¾"
43583-18 18 cm, 7"

0-20 mm



COLLIER
73193-30
30 cm, 11¾"

HADEO
INSTRUMENTE GERMANY

Dermatome
Dermatome
Dermàtomo
Dermatomo



SCHINK
07490-00
30 cm, 11³/₄"

compl.
mit/with/con
07490-01 (1) Stk./pcs
07490-02 (2) Stk./pcs



07490-01

Ersatzklinge
Spare blade
Hoja de repuesto
Lama di ricambio per dermatomo

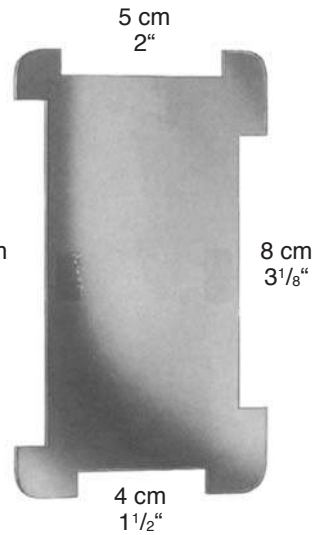

07490-02

Spannplatte
Skin straightening plate
Placa para extender la piel
Placca per stendipelle

HADEO
INSTRUMENTE GERMANY

Dermatome
Dermatome
Dermátomo
Dermatomo



HUMBY
07495-31
31 cm, 12¹/₄"



SILVER
07498-00
19 cm, 7¹/₂"



WATSON
07499-00
30 cm, 11³/₄"

Ersatzklingen, unsteril / Spare blade, non sterile
Hoja de repuesto, no esteril / Lama di ricambio, non sterile

07496-31

07296-00

07499-01

HADEO
INSTRUMENTE GERMANY

Skalpellgriffe
Scalpel Handles
Mangos de bisturíes
Manici per lama bisturi

passend zu den Klingen
for blades
para las hojas
per lama bisturi

(A) No. 10, 11, 12, 13, 14, 15, 16, 17, 18, 19



07103-00
Fig. 3

(A)



07103-01
Fig. 3 grad

(A)



07103-02
Fig. 3 L

(A)



07103-03
Fig. 3 L

(A)

HADEO
INSTRUMENTE GERMANY

Skalpellgriffe
Scalpel Handles
Mangos de bisturíes
Manici per lama bisturi

passend zu den Klingen
for blades
para las hojas
per lama bisturi

- (A) No. 10, 11, 12, 13, 14, 15, 16, 17, 18, 19
- (B) No. 20, 21, 22, 23, 24, 25



07104-00
Fig. 4

(B)



07104-02
Fig. 4 L

(B)



07105-02
Fig. 4 L

(B)



07106-01
Fig. 3

(A)

HADEO
INSTRUMENTE GERMANY

Skalpellsgriffe
Scalpel Handles
Mangos de bisturíes
Manici per lama bisturi

passend zu den Klängen
for blades
para las hojas
per lama bisturi

- (A) No. 10, 11, 12, 13, 14, 15, 16, 17, 18, 19
- (B) No. 20, 21, 22, 23, 24, 25



07107-00
Fig. 7

(A)



07107-01
Fig. 7K

(A)



07108-00
Fig. 8

(B)

HADEO
INSTRUMENTE GERMANY

Mini-Skalpellgriffe/Skalpellklingen
Scalpel Handles
Mangos de bisturíes
Manici per lama bisturi/lame per bisturi



07161-00 07162-00 07165-00 07167-00

Packung mit 10 Stück
box of 10
en cajas de 10 unidades
confezione di 10 pezzi

07109-10 10,0 cm, 4"
07109-13 13,0 cm, 5¹/₈"
07109-15 15,5 cm, 6"



HADEO
INSTRUMENTE GERMANY

Skalpellgriffe
Scalpel Handles
Mangos de bisturías
Manici per lama bisturi

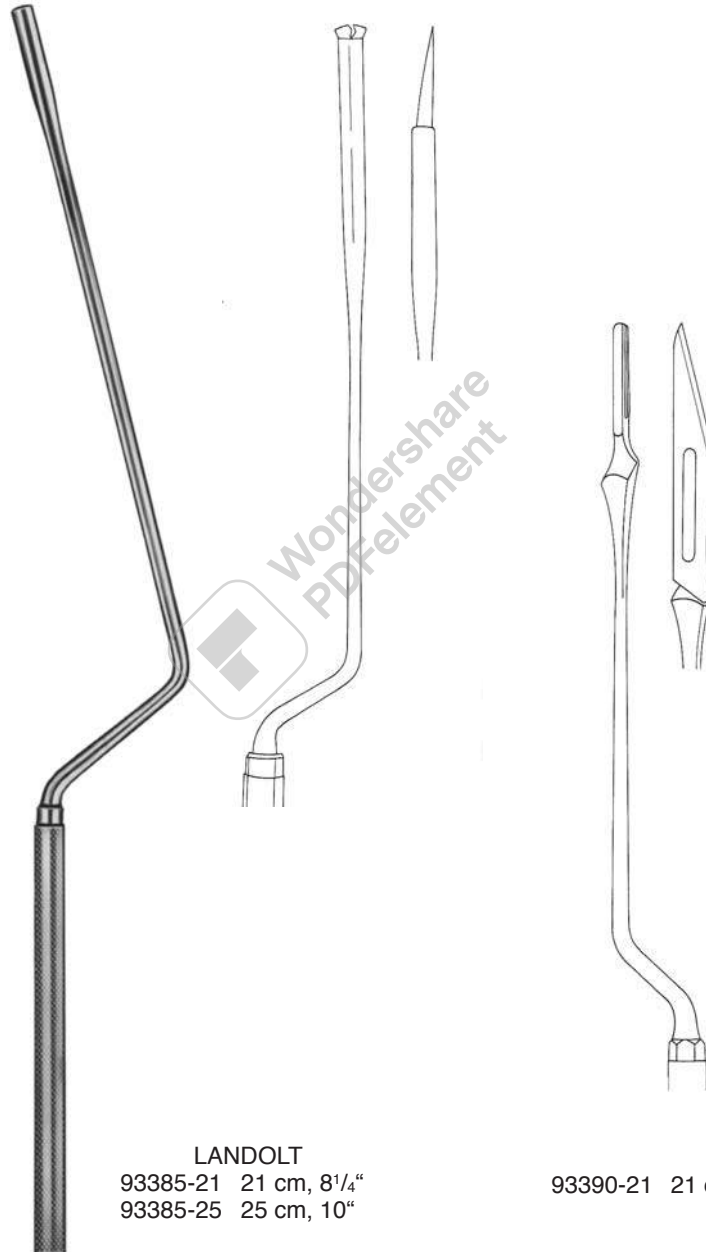

HADEO
INSTRUMENTE GERMANY

Präparierscheren
Dissecting Scissors
Tijeras de disección
Forbici per dissezione



MAYO



09160-14	14 cm, 5 ¹ / ₂ "	09161-14
09164-14 TC	14 cm, 5 ¹ / ₂ "	09165-14 TC
09962-14 SC	14 cm, 5 ¹ / ₂ "	09963-14 SC

09160-17	17 cm, 6 ³ / ₄ "	09161-17
09164-17 TC	17 cm, 6 ³ / ₄ "	09165-17 TC
09962-17 SC	17 cm, 6 ³ / ₄ "	09963-17 SC

HADEO
INSTRUMENTE GERMANY

Präparierscheren
Dissecting Scissors
Tijeras de disección
Forbici per dissezione



MAYO-STILLE

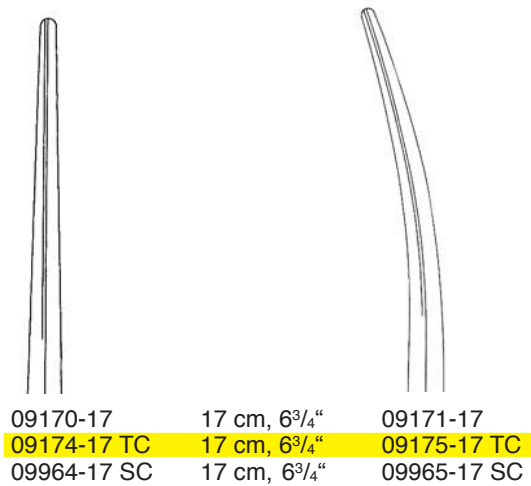
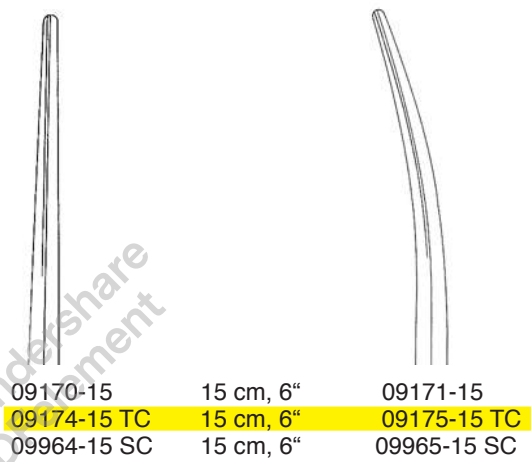

HADEO
INSTRUMENTE GERMANY

Präparierscheren
Dissecting Scissors
Tijeras de disección
Forbici per dissezione



LEXER



09190-16
09194-16 TC

16 cm, 6¹/₄"
16 cm, 6¹/₄"



09191-16
09195-16 TC



LEXER-BABY



09202-10
09206-10 TC

10 cm, 4"
10 cm, 4"



09203-10
09207-10 TC

HADEO

INSTRUMENTE GERMANY

Präparierscheren
Dissecting Scissors
Tijeras de disección
Forbici per dissezione



METZENBAUM





09280-12	12 cm, 4 ³ / ₄ "	09281-12
09284-12 TC	12 cm, 4³/₄"	09285-12 TC
09966-11 SC	12 cm, 4 ³ / ₄ "	09967-11 SC
09280-15	15 cm, 6"	09281-15
09284-15 TC	15 cm, 6"	09285-15 TC
09970-14 SC	15 cm, 6"	09971-14 SC
09280-18	18 cm, 7"	09281-18
09284-18 TC	18 cm, 7"	09285-18 TC
09970-18 SC	18 cm, 7"	09971-18 SC
09280-20	20 cm, 8"	09281-20
09284-20 TC	20 cm, 8"	09285-20 TC
09970-20 SC	20 cm, 8"	09971-20 SC
09280-23	23 cm, 9"	09281-23
09284-23 TC	23 cm, 9"	09285-23 TC
09970-23 SC	23 cm, 9"	09971-23 SC

HADEO
INSTRUMENTE GERMANY

Präparierscheren
Dissecting Scissors
Tijeras de disección
Forbici per dissezione





METZENBAUM

		
09270-15	15 cm, 6"	09271-15
09270-18	18 cm, 7"	09271-18
09274-15 TC	15 cm, 6"	09275-15 TC
09274-18 TC	18 cm, 7"	09275-18 TC



METZENBAUM-FINO

		
09282-15	15 cm, 6"	09283-15
09286-15 TC	15 cm, 6"	09287-15 TC
09282-18	18 cm, 7"	09283-18
09286-18 TC	18 cm, 7"	09287-18 TC
09282-20	20 cm, 8"	09283-20
09286-20 TC	20 cm, 8"	09287-20 TC
09282-23	23 cm, 9"	09283-23
09286-23 TC	23 cm, 9"	09287-23 TC

HADEO
INSTRUMENTE GERMANY

Präparierscheren
Dissecting Scissors
Tijeras de disección
Forbici per dissezione



SANVENERO



09302-14 14 cm, 5 1/2"



09303-14



JOSEPH



09304-14 14 cm, 5 1/2"



09305-14

HADEO
INSTRUMENTE GERMANY

Präparierscheren
Dissecting Scissors
Tijeras de disección
Forbici per dissezione



KILNER (RAGNELL)



09310-12	12 cm, 4 ³ / ₄ "
09314-12 TC	12 cm, 4 ³ / ₄ "
09995-12 SC	12 cm, 4 ³ / ₄ "
09310-15	15 cm, 6"



REYNOLDS (JAMESON)

09321-15	15 cm, 6"
09993-15 SC	15 cm, 6"
09321-18	18 cm, 7"

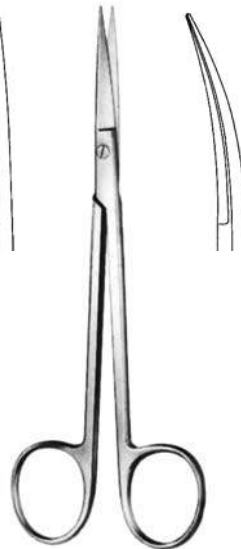

KELLY

09540-16	16 cm, 6 ¹ / ₄ "	09541-16
09542-16 TC	16 cm, 6 ¹ / ₄ "	09543-16 TC
09544-16 SC	16 cm, 6 ¹ / ₄ "	09545-16 SC

HADEO
INSTRUMENTE GERMANY

Feine Scheren
Delicate Scissors
Tijeras finas
Forbici delicate

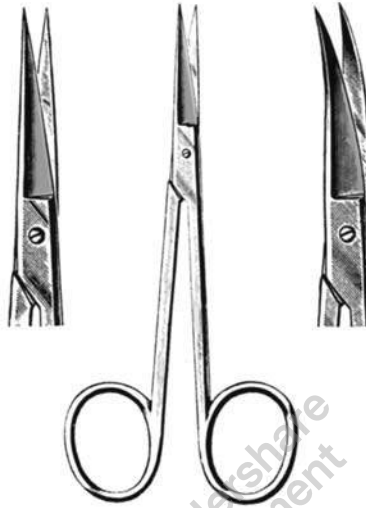

IRIS

09340-09	9 cm, 3 1/2"	09341-09
09340-10	10 cm, 4"	09341-10
09340-11	11 cm, 4 3/8"	09341-11
09344-11 TC	11 cm, 4 3/8"	09345-11 TC
09980-11 SC	11 cm, 4 3/8"	09981-11 SC



BONN

09342-08 8 cm, 3 1/8" 09343-08

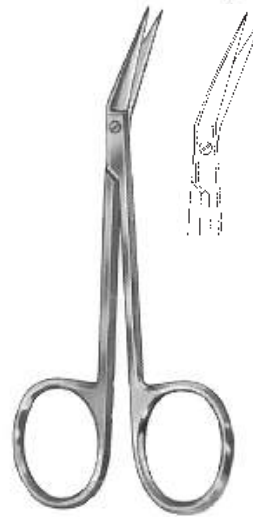

IRIS

09346-11
11 cm, 4 3/8"

HADEO
INSTRUMENTE GERMANY

Feine Scheren
Delicate Scissors
Tijeras finas
Forbici delicate



KNAPP
10 cm, 4"



09348-01



09348-02



09348-03



09348-04



09348-05



09348-06

HADEO
INSTRUMENTE GERMANY

Feine Scheren
Delicate Scissors
Tijeras finas
Forbici delicate



LITTLER
09349-12
12 cm, 4³/₄"



GRAEFE
09350-10
10 cm, 4"

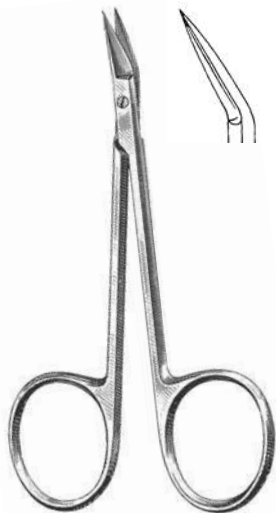

CONVERSE/WILMER/WALTER
09352-10
10 cm, 4"



COTTLE
09358-11
11 cm, 4³/₈"

HADEO
INSTRUMENTE GERMANY

Feine Scheren
Delicate Scissors
Tijeras finas
Forbici delicate



GRADLE
09350-09 9,5 cm, 3³/₄" 09351-09



09352-09 9,5 cm, 3³/₄" 09353-09



09354-10 10 cm, 4" 09355-10



09356-10 10 cm, 4" 09357-10

HADEO
INSTRUMENTE GERMANY

Feine Scheren
Delicate Scissors
Tijeras finas
Forbici delicate

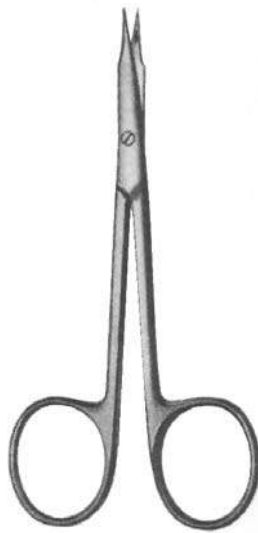

STEVENS
11 cm, 4³/₈"

spitz
sharp
agudo
acuti



09360-11
09984-11SC



09361-11
09985-11 SC



stumpf
blunt
romo
smussi



09362-11



09363-11

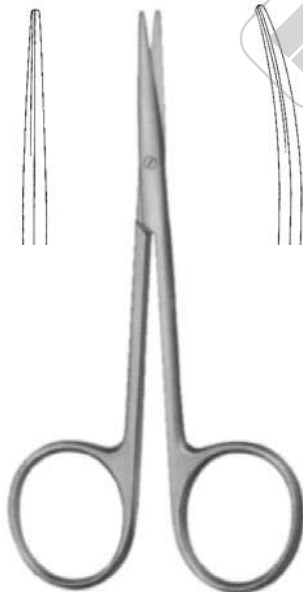

STRABISMUS

09370-11 11 cm, 4³/₈" 09371-11
09374-11TC 11 cm, 4³/₈" 09375-11TC

HADEO
INSTRUMENTE GERMANY

Feine Scheren
Delicate Scissors
Tijeras finas
Forbici delicate



WAGNER
12 cm, 4³/₄"



09828-12



09826-12



09824-12
09982-12SC



WAGNER
12 cm, 4³/₄"



09823-12



09829-12



09825-12
09983-12 SC

HADEO
INSTRUMENTE GERMANY

Zahnfleischscheren
Gum Scissors
Tijeras para encias
Forbici gengivali



LA GRANGE
09854-11
11,5 cm, 4½"

CHADWICK
09855-11
11,5 cm, 4½"

HADEO
INSTRUMENTE GERMANY

Nasenschere
Nasal Scissors
Tijeras nasales
Forbici nasali



HEYMAN
09401-18 18 cm, 7"



FOMON
09403-15 15 cm, 6"



COTTLE
09405-16 16 cm, 6 1/4"
09405-16TC 16 cm, 6 1/4"



COTTLE-MASING
09406-10 10 cm, 4" 09407-10



FOMON
09617-13 13 cm, 5 1/8"

HADEO
INSTRUMENTE GERMANY

Fadenscheren
Stitch Scissors
Tijeras para hilos
Forbici taglia fili



SPENCER
09802-09 9 cm, 3 $\frac{1}{2}$ "
09802-11 11 cm, 4 $\frac{3}{8}$ "



LITTAUER
09804-14
14 cm, 5 $\frac{1}{2}$ "



O`BRIEN
09805-09
9 cm, 3 $\frac{1}{2}$ "

HADEO
INSTRUMENTE GERMANY

Knorpelscheren/Zahnfleischscheren
Cartilage Scissors/Gum Scissors
Tijeras para cartilago/Tijeras para encías
Forbici per cartilagine/Forbici gengivali



MC INDOE
09614-19
19 cm, 7 1/2"

1 Schneide gezahnt
1 blade toothed
1 hoja dentada
1 taglio dentellato



09820-13 GOLDMAN-FOX 09821-13
13 cm, 5 1/8" 09821-13SC

HADEO
INSTRUMENTE GERMANY

Face-Lift Scheren
Face-Lift Scissors
Face Lift tijeras
Face Lift forbici



GORNEY



10010-19
10012-19 TC
10014-19 SC

19 cm, 7 1/2"
19 cm, 7 1/2"
19 cm, 7 1/2"



10011-19
10013-19 TC
10015-19 SC



GORNEY-FREEMAN

10061-19 19 cm, 7 1/2"
10061-19 TC 19 cm, 7 1/2"
10061-19 SC 19 cm, 7 1/2"

10061-23 23 cm, 9"
10061-23 TC 23 cm, 9"
10061-23 SC 23 cm, 9"

HADEO
INSTRUMENTE GERMANY

Face-Lift Scheren
Face-Lift Scissors
Face-Lift tijeras
Face Lift forbici



KAYE

10028-14 TC	14 cm, 5 1/2"	10029-14 TC
10034-14 SC	14 cm, 5 1/2"	10035-14 SC
10030-18 TC	18 cm, 7"	10031-18 TC
10036-18 SC	18 cm, 7"	10037-18 SC
10032-23 TC	23 cm, 9"	10033-23 TC
10038-23 SC	23 cm, 9"	10039-23 SC



PECK-JOSEPH

10044-14	14,5 cm, 5 3/4"	10045-14
10048-14 SC	14,5 cm, 5 3/4"	10049-14 SC



BEUSE

10050-14	14 cm, 5 1/2"	10051-14
10050-18	18 cm, 7"	10051-18

HADEO
INSTRUMENTE GERMANY

Blepharoplastik Scheren
Blepharoplasty Scissors
Tijeras para blefaroplastia
Forbici per blefaroplastica

**GREENBERG-PAR**

10201-11 11,5 cm 4 1/2"
10201-11SC 11,5 cm 4 1/2"

**KAYE**

10206-11 11,5 cm, 4 1/2" 10207-11
10206-11SC 11,5 cm, 4 1/2" 10207-11SC

HADEO
INSTRUMENTE GERMANY

Mikro Scheren
Micro Scissors
Micro tijeras
Micro Forbice

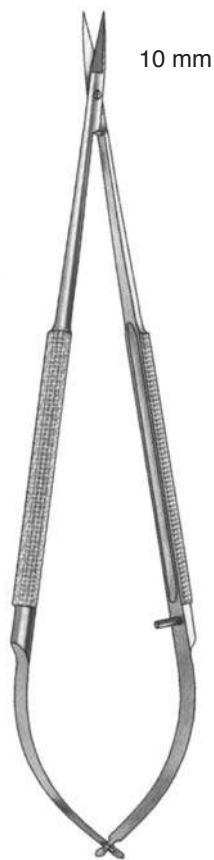

10 mm

11 cm
4³/₈"

10202-11

10203-11

14,5 cm
5³/₄"

10202-14
10202-14T

10203-14
10203-14T

18 cm
7"

10202-18
10202-18T

10203-18
10203-18T

21 cm
8¹/₄"

10202-21
10202-21T

10203-21
10203-21T

23 cm
9"

10202-23

10203-23

T= Titan, titanium, titanio, titanio

HADEO
INSTRUMENTE GERMANY

Mikro Scheren
Micro Scissors
Micro tijeras
Micro Forbice

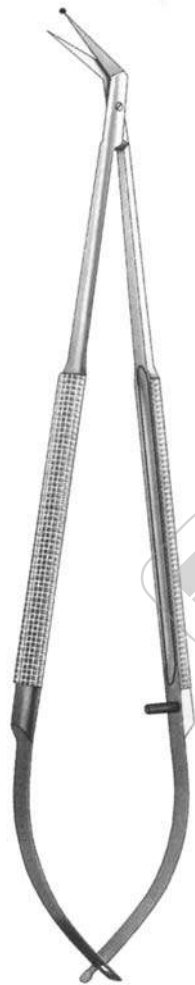

18 cm 7"



25°

10220-25
10220-25T



45°

10220-45
10220-45T



60°

10220-60
10220-60T

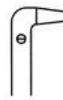

90°

10220-90
10220-90T



125°





10220-00
10220-00T

T= Titan, titanium, titanio, titanio

HADEO
INSTRUMENTE GERMANY

Mikro Scheren
Micro Scissors
Micro tijeras
Micro Forbice



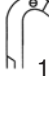



	11 cm 4 ³ / ₈ "	14,5 cm 5 ³ / ₄ "	18 cm 7"	21 cm 8 ¹ / ₄ "	23 cm 9"
 25°	10226-11	10226-14	10226-18 10226-18T	10226-21	10226-23
 45°	10227-11	10227-14	10227-18 10227-18T	10227-21	10227-23
 60°	10228-11	10228-14	10228-18 10228-18T	10228-21	10228-23
 90°	10229-11	10229-14	10229-18 10229-18T	10229-21	10229-23
 125°	10230-11	10230-14	10230-18 10230-18T	10230-21	10230-23

T= Titan, titanium, titanio, titanio

HADEO
INSTRUMENTE GERMANY









Anatomische und chirurgische Pinzetten
Dressing and Tissue Forceps
Pinzas de disección sin/con dientes
Pinze per dissezione, chirurgiche/anatomiche

				
STANDARD			USA	STILLE
cm				
10,5 4 1/4"	11102-10			
11,5 4 1/2"	11102-11			
12,0 4 3/4"			11104-12	
13,0 5 1/8"	11102-13		11104-13	11106-13
14,5 5 3/4"	11102-14	11103-14	11104-14	
15,0 6"				11106-15
15,5 6"			11104-15	
16,0 6 1/4"	11102-16			
18,0 7"	11102-18		11104-18	
20,0 8"	11102-20			
21,0 8 1/4"			11104-21	

			
schmal narrow estrecha stretta		POTTS-SMITH	POTTS-SMITH 1x2
cm			
11,5 4 1/2"	11110-11		
13,0 5 1/8"	11110-13		
14,5 5 3/4"	11110-14	11114-14 TC	
16,0 6 1/4"	11110-16	11114-16 TC	
18,0 7"	11110-18	11112-18	11116-18 TC
20,0 8"	11110-20	11114-20 TC	11126-18
21,0 8 1/4"		11112-21	11116-21 TC
25,0 10"	11110-25	11112-25	11116-25 TC
			11126-21
			11126-25



Chirurgische Pinzetten
Tissue Forceps
Pinzas de disección con dientes
Pinze per dissezione, chirurgiche

				
	1x2	1x2	1x2	1x2
	STANDARD	USA	STILLE	schmal narrow estrecha stretta
cm				
10,5 4 1/4"	11120-10			
11,5 4 1/2"	11120-11			11130-11
12,0 4 3/4"		11122-12		
13,0 5 1/8"	11120-13	11122-13		11130-13
14,5 5 3/4"	11120-14	11122-14		11130-14
15,0 6"			11124-15	
15,5 6"		11122-15		
16,0 6 1/4"	11120-16			11130-16
18,0 7"	11120-18	11122-18		11130-18
20,0 8"	11120-20			11130-20
21,0 8 1/4"		11122-21		
				
	OEHLER	2x3	3x4	4x5
cm				
11,5 4 1/2"		11140-11		
13,0 5 1/8"		11140-13	11150-13	11160-13
14,5 5 3/4"		11140-14	11150-14	11160-14
16,0 6 1/4"	11132-16 TC	11140-16	11150-16	11160-16
18,0 7"	11132-18 TC	11140-18		
20,0 8"	11132-20 TC	11140-20		



Anatomische und chirurgische Pinzetten
 Dressing and Tissue Forceps
 Pinzas de disección sin/con dientes
 Pinze per dissezione, chirurgiche/anatomiche



ADSON
 11170-12 12,0 cm, 4 3/4"
 11170-15 15,0 cm, 6"



ADSON
 11170-12F 12 cm, 4 3/4"

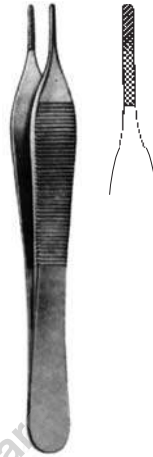

ADSON
 11174-12 TC 12,0 cm, 4 3/4"
 11174-15 TC 15,0 cm, 6"



ADSON micro
 11176-12 12,0 cm, 4 3/4"
 11176-15 15,0 cm, 6"



ADSON-DeBAKEY atraumatic
 11177-12
 12,0 cm, 4 3/4"

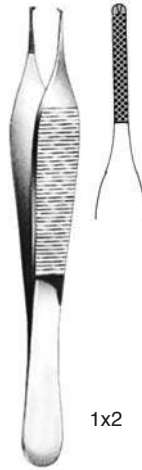

ADSON
 11178-12
 12,0 cm, 4 3/4"

1x2



ADSON
 11179-12
 12 cm, 4 3/4"

2x3



Chirurgische Pinzetten
Tissue Forceps
Pinzas de disección con dientes
Pinze per dissezione, chirurgiche



1x2

ADSON
11180-12 12,0 cm, 4 3/4"
11180-15 15,0 cm, 6"



1x2

ADSON
11180-12F 12 cm, 4 3/4"

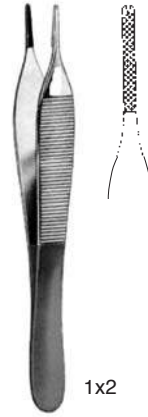

1x2

ADSON
11181-12 TC 12,0 cm, 4 3/4"
11181-15 TC 15,0 cm, 6"



BEASELEY BABCOCK
11182-12 12 cm, 4 3/4"



1x2

ADSON micro
11186-12 12,0 cm, 4 3/4"
11186-15 15,0 cm, 6"



1x2

ADSON
11187-12 12 cm, 4 3/4"

HADEO
INSTRUMENTE GERMANY

Chirurgische Pinzetten
Tissue Forceps
Pinzas de disección con dientes
Pinze per dissezione, chirurgiche



7x7

ADSON-BROWN
11188-12 12,0 cm, 4 3/4"
11188-15 15,0 cm, 6"
11189-12 TC 12,0 cm, 4 3/4"



7x7

ADSON-BROWN
11188-12F 12 cm, 4 3/4"



7x7

ADSON-BROWN
11191-12 12 cm, 4 3/4"



Anatomische und chirurgische Pinzetten
 Dressing and Tissue Forceps
 Pinzas de disección sin/con dientes
 Pinze per dissezione, chirurgiche/anatomiche



1x2

WAUGH

- 11187-18 18 cm, 7"
- 11187-20 20 cm, 8"
- 11187-25 25 cm, 10"
- 11187-30 30 cm, 11 3/4"



9x9

BROWN

- 11189-15 15,0 cm, 6"
- 11189-20 20,0 cm, 8"
- 11189-25 25,0 cm, 10"



GRAEFE

- 11190-10 10,5 cm, 4.1"



11221-17

CUSHING

- 11220-17
- 11224-17 TC**
- 17,0 cm, 6 3/4"



11223-17

CUSHING

- 11222-17
- 11225-17 TC**
- 17,0 cm, 6 3/4"



5x6

LERCHE

- 11232-15
- 15,0 cm, 6"

HADEO
INSTRUMENTE GERMANY

Anatomische und chirurgische Pinzetten
Dressing and Tissue Forceps
Pinzas de disección sin/con dientes
Pinze per dissezione, chirurgiche/anatomiche



1x2

FERRIS-SMITH
11246-18
18,0 cm, 7"



2x3

FERRIS-SMITH
11248-18
18,0 cm, 7"



DUVAL
11250-14
14,5 cm, 5 3/4"



COLLIN-DUVAL
11252-20
20,0 cm, 8"



Russ. Mod.
11256-15 15,0 cm, 6"
11256-20 20,0 cm, 8"
11256-25 25,0 cm, 10"



1x2

McINDOE
11257-15
15,0 cm, 6"



McINDOE
11258-15 15,0 cm, 6"
11259-15 TC 15,0 cm, 6"

HADEO
INSTRUMENTE GERMANY

Anatomische und chirurgische Pinzetten
Dressing and Tissue Forceps
Pinzas de disección sin/con dientes
Pinze per dissezione, chirurgiche/anatomiche



SEMKEN

11260-12 12,5 cm, 5"
11260-15 15,5 cm, 6"
11261-15 TC 15,5 cm, 6"



1x2

SEMKEN

11270-12 12,5 cm, 5"
11270-15 15,5 cm, 6"
11271-15 TC 15,5 cm, 6"
11271-18 TC 18 cm, 7"



1x2

GILLIES

11272-15 15,5 cm, 6"
11273-15 TC 15,5 cm, 6"



15,5 cm, 6"

11274-06
0,6 mm

11274-08
0,8 mm

11274-10
1,0 mm



GERALD

11302-17 17,5 cm, 6,9"
11302-23 23,0 cm, 9"
11304-17 TC 17,0 cm, 6 3/4"



GERALD

11303-17
17,5 cm, 6,9"



Anatomische und chirurgische Pinzetten
 Dressing and Tissue Forceps
 Pinzas de disección sin/con dientes
 Pinze per dissezione, chirurgiche/anatomiche



GERALD
 11305-17
 17,5 cm, 6.9"



GERALD
 11310-17 17,5 cm, 6.9"
 11312-17 TC 17,5 cm, 6.9"



GERALD
 11311-17
 17,5 cm, 6.9"



CUSHING-TAYLOR
 11312-18 TC
 18,5 cm, 7 1/4"



GERALD
 11313-17
 17,5 cm, 6.9"



11314-01



11314-02



TAYLOR
 17 cm, 6 3/4"



11315-01



11315-02

TAYLOR
 17 cm, 6 3/4"

HADEO
INSTRUMENTE GERMANY

Anatomische und chirurgische Pinzetten
Dressing and Tissue Forceps
Pinzas de disección sin/con dientes
Pinze per dissezione, chirurgiche/anatomiche

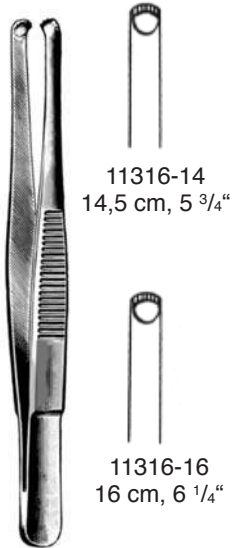

11316-14
14,5 cm, 5 3/4"

11316-16
16 cm, 6 1/4"



11316-20
20 cm, 8"

DURANTE

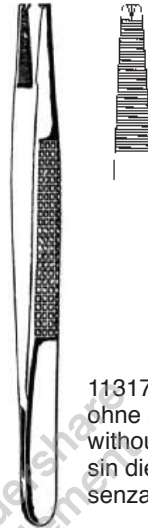

BONNEY
18 cm, 7"

- 11317-12 1x2
- 11317-23 2x3
- 11319-12 TC 1x2

11317-00
ohne Zähne
without teeth
sin dientes
senza denti

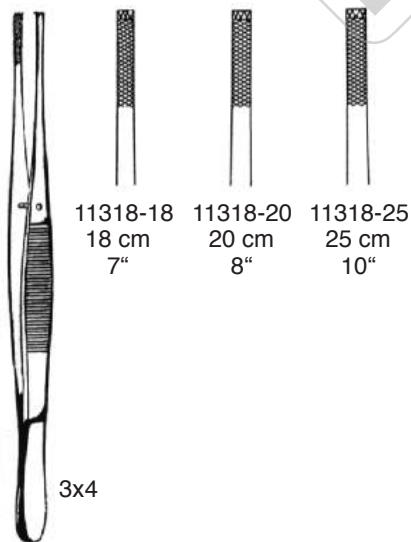

11318-18
18 cm
7"

11318-20
20 cm
8"

11318-25
25 cm
10"

3x4

STILLE-BARRAYA

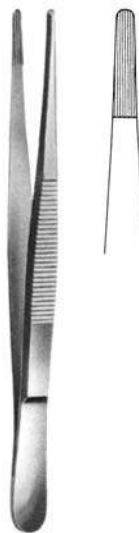

OCHSNER
11319-14
14,5 cm, 5 3/4"



SINGLEY
11320-18 18 cm, 7"
11320-23 23 cm, 9"



Splitterpinzetten
 Splinter Forceps
 Pinzas para espinas
 Pinze per schegge

Fig.: 1



11401-01
 12 cm, 4 3/4"

3



11403-03
 12 cm, 4 3/4"

3c



11403-04
 11 cm, 4 3/8"

Fig.: 4



11404-04
 11 cm, 4 3/8"

5



11405-05
 11 cm, 4 3/8"

7



11407-07
 12 cm, 4 3/4"



Mikro- Knüpfpinzetten
 Micro Suture Tying Forceps
 Micro pinzas para ligaduras
 Micro pinze per legature



	0,3 mm	0,8 mm
12 cm, 4 ³ / ₄ "	12102-12	
	12102-12D	
15 cm, 6"	12104-15	
	12104-15D	
18 cm, 7"		12108-18
		12108-18D
21 cm, 8 ¹ / ₄ "		12102-21
		12102-21D
23 cm, 9"		12102-23
		12102-23D



	0,3 mm	0,8 mm
12 cm, 4 ³ / ₄ "	12103-12	
	12103-12D	
15 cm, 6"	12103-15	
	12103-15D	
18 cm, 7"		12109-18
		12109-18D
21 cm, 8 ¹ / ₄ "		12109-21
		12109-21D
23 cm, 9"		12109-23
		12109-23D



	0,3 mm	0,3 mm
15 cm, 6"	12090-15D	12091-15D
18 cm, 7"	0,4 mm	0,4 mm
	12090-18D	12091-18D
21 cm, 8 ¹ / ₄ "	0,8 mm	0,8 mm
	12090-21D	12091-21D
23 cm, 9"	12090-23D	12091-23D



D = mit diamantiertem Maul
 with diamond jaw
 con boca de diamante
 con morso diamantato

HADEO

INSTRUMENTE GERMANY

Mikro- Ring-Pinzette mit diamantiertem Maul + TITAN
 Micro Ring Forceps with Diamond Jaw + Titanium
 Micro Pinzas con anillo con boca de diamante + Titanio
 Micro Pinza ad anello con morso diamantato +Titanio



	Ø 1 mm x 0,5 mm	Ø 2 mm x 1 mm
15 cm, 6"	12112-15D 12112-15T	12114-15D 12114-15T
18 cm, 7"	12112-18D 12112-18T	12114-18D 12114-18T
21 cm, 8 ¹ / ₄ "	12112-21D 12112-21T	12114-21D 12114-21T
23 cm, 9"	12112-23D 12112-23T	12114-23D 12114-23T

D = mit diamantiertem Maul
 with diamond jaw
 con boca de diamante
 con morso diamantato
 T = Titan, titanium, titanio, titanio

HADEO
INSTRUMENTE GERMANY

Atrauma- Mikro- Pinzette
Atrauma Micro Forceps
Micro pinza atraumaticas
Micro Pinza Atraumatica



	1,2 mm	2,0 mm
15 cm, 6"	12115-15 12115-15T	12116-15
18 cm, 7"	12115-18 12115-18T	12116-18
21 cm, 8 ¹ / ₄ "	12115-21 12115-21T	12116-21
23 cm, 9"	12115-23 12115-23T	12116-23

T = Titan, titanium, titanio, titanio

De BAKEY

HADEO
INSTRUMENTE GERMANY

TC Atrauma Pinzette
TC Atrauma Forceps
Pinza atraumaticas con TC
Pinza Atraumatica TC

Wondershare
PDFelement

	1,2 mm	2,0 mm
18 cm, 7"	12117-18 TC	12118-18 TC
21 cm, 8¼"	12117-21 TC	12118-21 TC
23 cm, 9"	12117-23 TC	12118-23 TC

De BAKEY TC

HADEO
INSTRUMENTE GERMANY

Atraumatische Pinzetten
Atraumatic Tissue Forceps
Pinzas atraumaticas
Pinze Atraumatiche



DE BAKEY
12302-16 16 cm, 6 1/4"
12302-20 20 cm, 8"
12302-24 24 cm, 9 1/2"

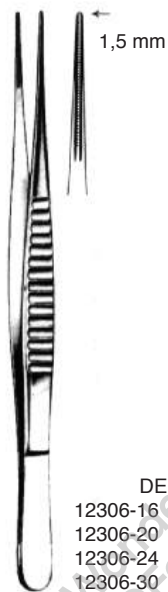

DE BAKEY
12306-16 16 cm, 6 1/4"
12306-20 20 cm, 8"
12306-24 24 cm, 9 1/2"
12306-30 30 cm, 11 3/4"



DE BAKEY
12308-16 16 cm, 6 1/4"
12308-20 20 cm, 8"
12308-24 24 cm, 9 1/2"
12308-30 30 cm, 11 3/4"



DE BAKEY
12309-16 16 cm, 6 1/4"
12309-20 20 cm, 8"
12309-24 24 cm, 9 1/2"
12309-30 30 cm, 11 3/4"



DE BAKEY
12304-16 16 cm, 6 1/4"
12304-20 20 cm, 8"
12304-24 24 cm, 9 1/2"
12304-30 30 cm, 11 3/4"

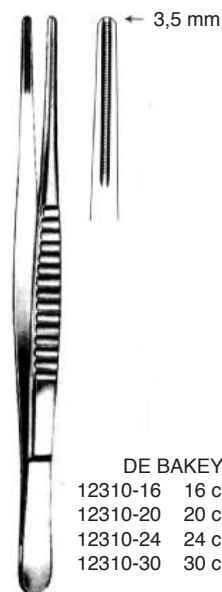

DE BAKEY
12310-16 16 cm, 6 1/4"
12310-20 20 cm, 8"
12310-24 24 cm, 9 1/2"
12310-30 30 cm, 11 3/4"

HADEO
INSTRUMENTE GERMANY

Iris Pinzetten
Iris Forceps
Pinzas para iris
Pinze per iride



GRAEFE
43810-10
10 cm, 4"



GRAEFE
43811-10
10 cm, 4"



GRAEFE
43813-10
10 cm, 4"



GRAEFE
43820-10
10 cm, 4"

1x2



GRAEFE
43821-10
10 cm, 4"

1x2



GRAEFE
43823-10
10 cm, 4"

1x2

HADEO
INSTRUMENTE GERMANY

Iris Pinzetten
Iris Forceps
Pinzas para iris
Pinze per iride



BISHOP-HARMAN
43940-05 8,5 cm, 3.4"
0,5 mm



BISHOP-HARMAN
43940-08 8,5 cm, 3.4"
0,8 mm



BISHOP-HARMAN
43942-05 8,5 cm, 3.4"
0,5 mm

1x2



BISHOP-HARMAN
43942-08 8,5 cm, 3.4"
0,8 mm

1x2

HADEO
INSTRUMENTE GERMANY

Nahtpinzetten
Suture forceps
Pinzas para sutura
Pinza per sutura



MOD. TUEBINGEN
43950-10
10 cm, 4"



MOD. BONN
43952-10
10 cm, 4"/ 0,12 mm

1x2



MOD. TUEBINGEN
43953-10
10 cm, 4"



Muskelpinzetten, Nahtpinzetten, Chalazionspinzetten, Cilienpinzetten
 Muscle Forceps, Suture forceps, Forceps for Chalazion, Cilia Forceps
 Pinzas musculares, Pinza para sutura, Pinzas de chalazión, Pinza depilatorias
 Pinza muscolare, Pinza per sutura, Pinze per calazio, Pinza depilatoria

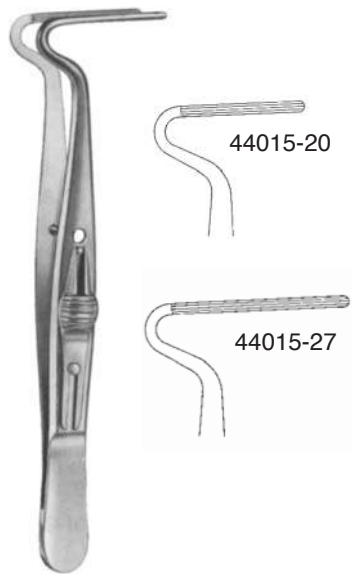

BERKE
10 cm, 4"



auch mit breitem Griff verfügbar
 also available with broad handle
 también disponible con apoyo ancho
 disponibile con impugnatura larga

- 44150-01 0,12 mm
- 44150-03 0,30 mm
- 44150-05 0,50 mm
- 44150-10 1,00 mm
- 44150-15 1,50 mm

CASTROVIEJO
10 cm, 4"



DESMARRES
9 cm, 3 1/2"

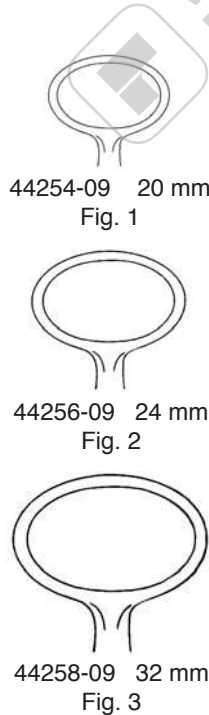

BARRAQUER
44425-10 10,5 cm, 4.1"

HADEO
INSTRUMENTE GERMANY

Fixierpinzetten
Fixation forceps
Pinzas para fijación
Pinze fissatrici



GREEN
10 cm, 4"

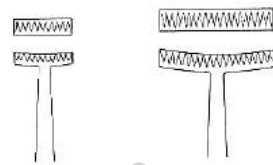

44076-05 44076-10
5 mm 10 mm

ohne Sperre
without catch
sin cierre
senza cremagliera

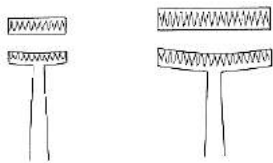

44078-05 44078-10
5 mm 10 mm

mit Sperre
with catch
con cierre
con cremagliera

HADEO
INSTRUMENTE GERMANY

Ohrpinzetten, Columellapinzette
Ear Forceps, Columella Forceps
Pinzas auriculares, Pinza para columela
Pinze auricolari, Pinza per columella



WILDE (TROELTSCH)
45201-11 11 cm, 4³/₈"



LUCAE
45206-14 14 cm, 5¹/₂"
45206-16 16 cm, 6¹/₄"

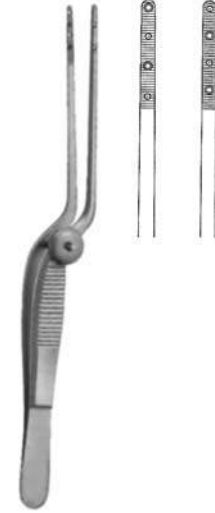

COTTLE
45208-14 14 cm, 5¹/₂"



TROELTSCH
47151-15 15 cm, 6"
47151-18 18 cm, 7"



JANSEN-GRUENWALD
47154-20 20 cm, 8"



COTTLE
47565-10 10 cm, 4"

HADEO
INSTRUMENTE GERMANY

Lidplatte
Lid Plate
Placa para párado
Placca per palpebre



JAEGER
43150-11 11 cm, 4³/₈"

HADEO
INSTRUMENTE GERMANY

Arterienklemmen
Artery Forceps
Pinzas hemostáticas
Pinze emostatiche



HARTMANN
13210-10 10 cm, 4"

Micro - HARTMANN
13214-10 10 cm, 4"

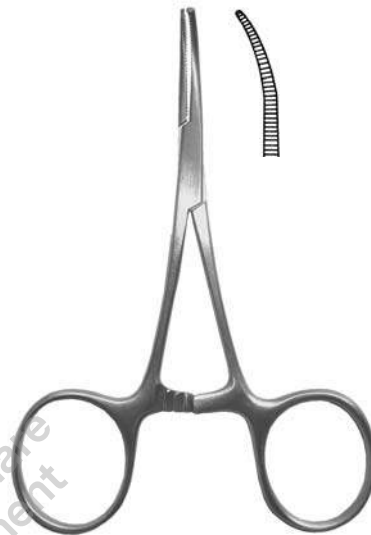

HARTMANN
13211-10 10 cm, 4"

Micro - HARTMANN
13215-10 10 cm, 4"

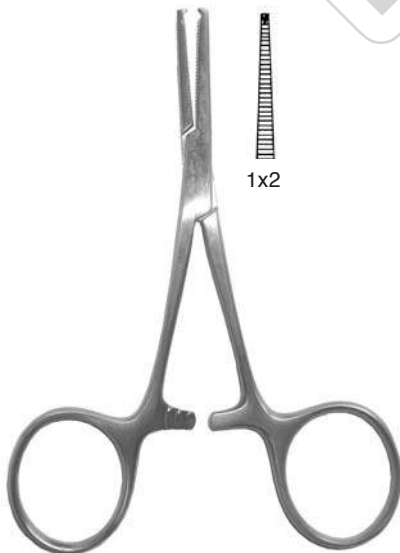

HARTMANN
13212-10 10 cm, 4"

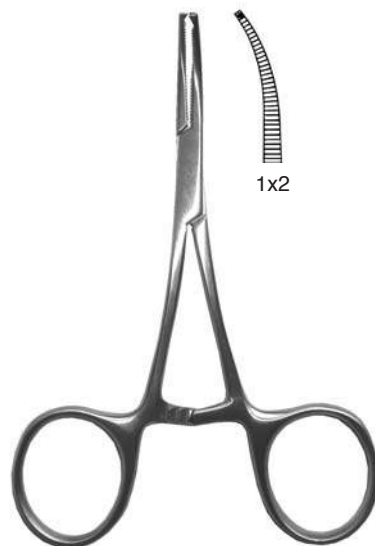

HARTMANN
13213-10 10 cm, 4"

HADEO
INSTRUMENTE GERMANY

Arterienklemmen
Artery Forceps
Pinzas hemostáticas
Pinze emostatiche

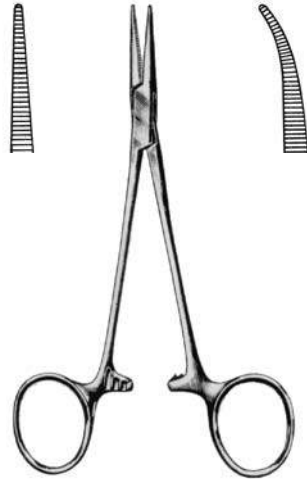

HALSTED-MOSQUITO

- | | | | | |
|------------------|----------|--------------|----------|------------------|
| 13224-12T | 13220-12 | 12,5 cm, 5" | 13221-12 | 13225-12T |
| | 13220-14 | 14,0 cm, 5½" | 13221-14 | |
| | 13220-18 | 18,0 cm, 7" | 13221-18 | |
| | 13220-21 | 21,0 cm, 8¼" | 13221-21 | |

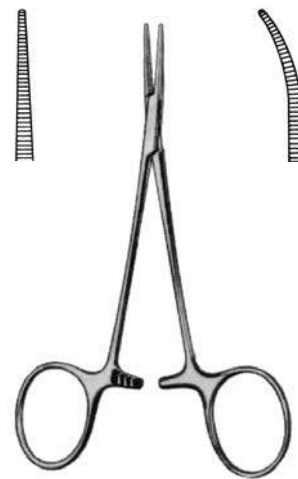

HALSTED-MOSQUITO micro

- | | | |
|----------------|--------------|----------|
| 13222-12 | 12,5 cm, 5" | 13223-12 |
| JACOBSEN micro | | |
| 13226-12 | 21,0 cm, 8¼" | 13227-12 |

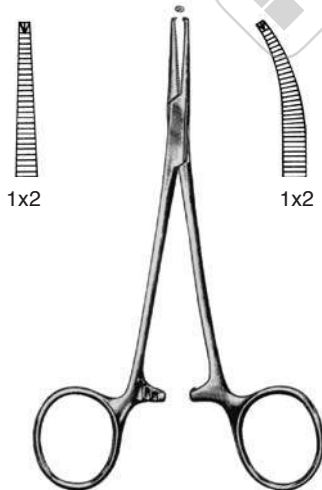

HALSTED-MOSQUITO

- | | | |
|----------|--------------|----------|
| 13230-12 | 12,5 cm, 5" | 13231-12 |
| 13230-14 | 14,0 cm, 5½" | 13231-14 |
| 13230-18 | 18,0 cm, 7" | 13231-18 |
| 13230-21 | 21,0 cm, 8¼" | 13231-21 |

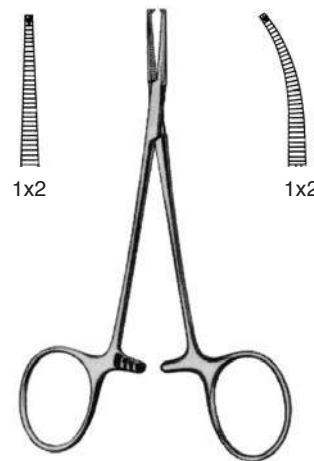

HALSTED-MOSQUITO micro

- | | | |
|----------|------------|----------|
| 13232-12 | 12 cm, 4¾" | 13233-12 |
|----------|------------|----------|

HADEO
INSTRUMENTE GERMANY

Arterienklemmen
Artery Forceps
Pinzas hemostáticas
Pinze emostatiche

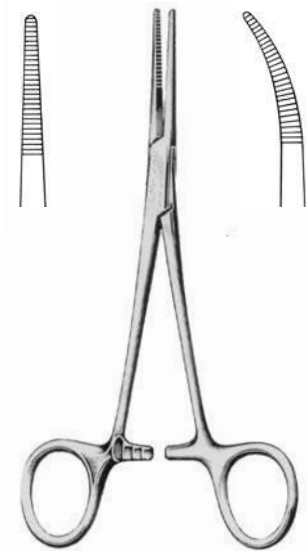

KELLY

- | | | |
|----------|---------------|----------|
| 13240-14 | 14 cm, 5 1/2" | 13241-14 |
| 13240-18 | 18 cm, 7" | 13241-18 |
| 13244-14 | 14 cm, 5 1/2" | 13245-14 |

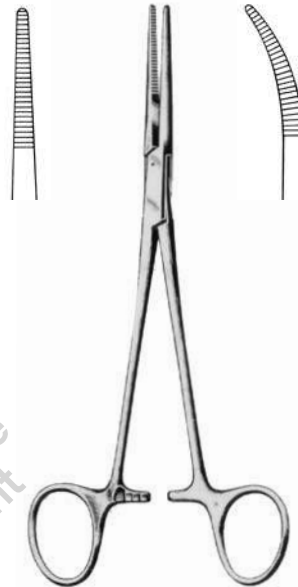

KELLY-RANKIN

- | | | |
|----------|---------------|----------|
| 13242-16 | 16 cm, 6 1/4" | 13243-16 |
|----------|---------------|----------|

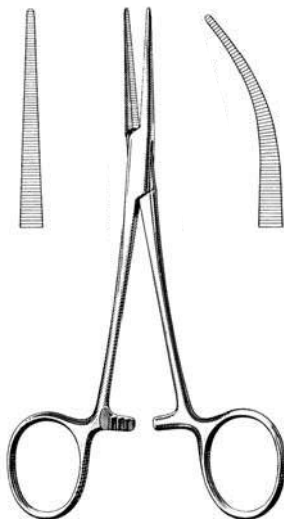

COLLER-CRILE

- | | | |
|----------|---------------|----------|
| 13256-14 | 14 cm, 5 1/2" | 13257-14 |
| 13258-16 | 16 cm, 6 1/4" | 13259-16 |

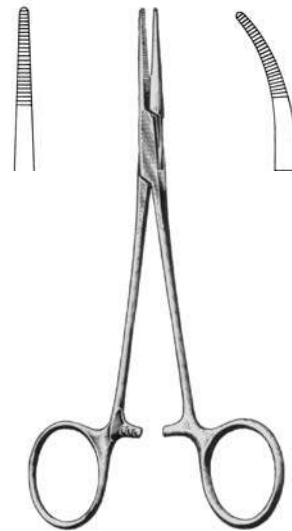

PROVIDENCE-HOSPITAL

- | | | |
|----------|---------------|----------|
| 13270-14 | 14 cm, 5 1/2" | 13271-14 |
|----------|---------------|----------|

HADEO
INSTRUMENTE GERMANY

Arterienklemmen
Artery Forceps
Pinzas hemostáticas
Pinze emostatiche

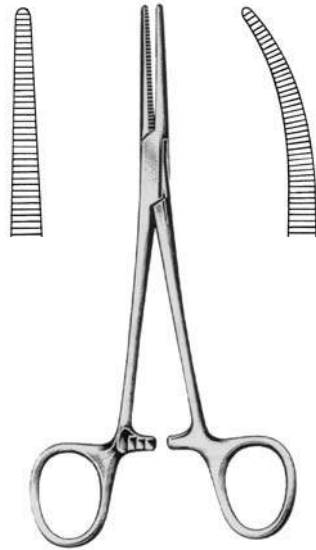

CRILE
13250-14 14 cm, 5 1/2" 13251-14
13250-18 18 cm, 7" 13251-18
13254-14 14 cm, 5 1/2" 13255-14

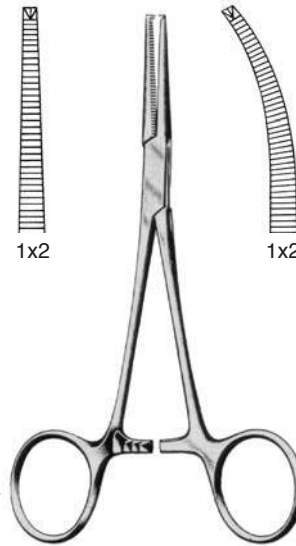

CRILE
13260-14 14 cm, 5 1/2" 13261-14

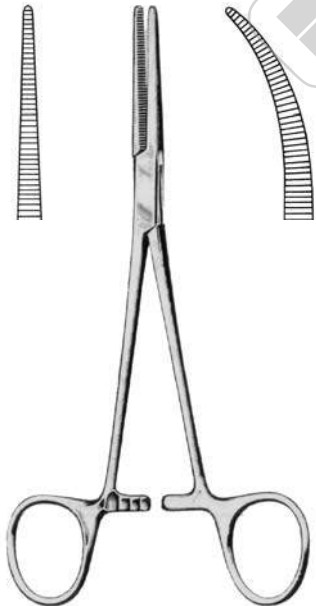

CRILE-RANKIN
13262-16 16 cm, 6 1/4" 13263-16

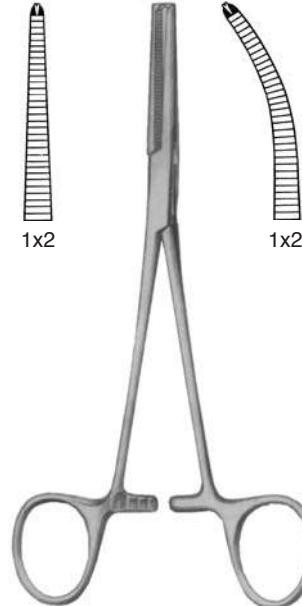

CRILE-RANKIN
13264-16 16 cm, 6 1/4" 13265-16

HADEO
INSTRUMENTE GERMANY

Arterienklemmen
Artery Forceps
Pinzas hemostáticas
Pinze emostatiche

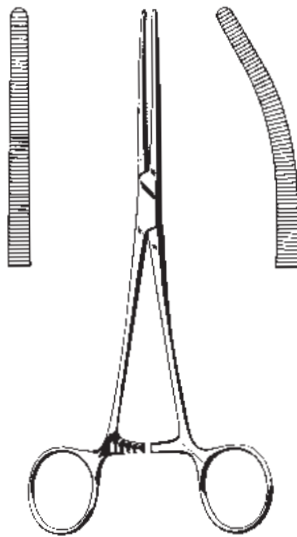

ROCHESTER-PEAN

13310-13 13,0 cm, 5 1/8" 13311-13
13310-14 14,0 cm, 5 1/2" 13311-14
13310-16 16,0 cm, 6 1/4" 13311-16

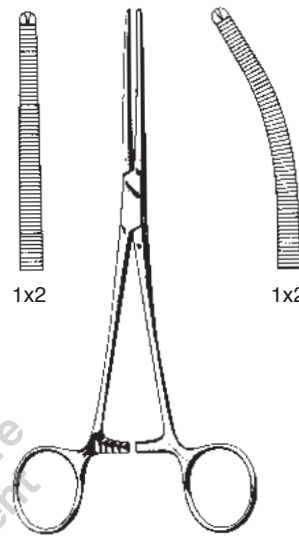

ROCHESTER-OCHSNER

13320-13 13,0 cm, 5 1/8" 13321-13
13320-14 14,0 cm, 5 1/2" 13321-14
13320-16 16,0 cm, 6 1/4" 13321-16

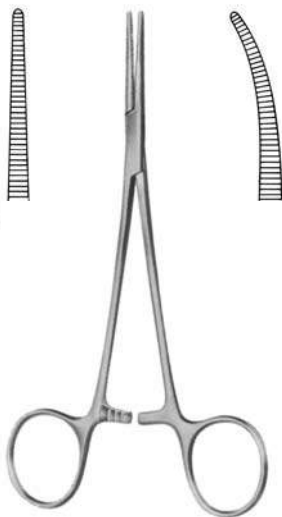

LERICHE

13380-15 15 cm, 6" 13381-15

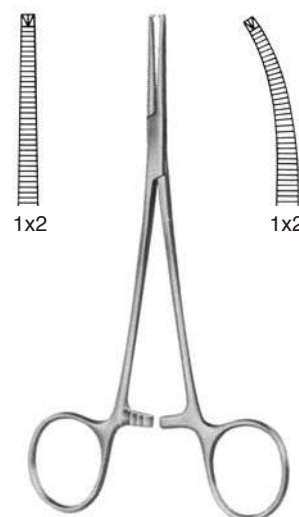

LERICHE

13382-15 15 cm, 6" 13383-15

HADEO
INSTRUMENTE GERMANY

Arterienklemmen
Artery Forceps
Pinzas hemostáticas
Pinze emostatiche

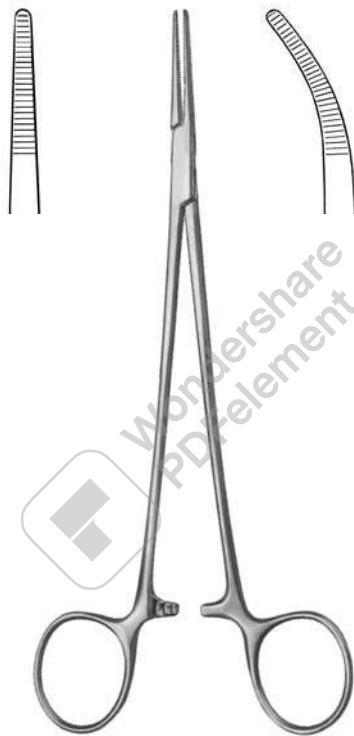

ADSON
13410-18 18,5 cm, 7¹/₄" 13411-18

HADEO
INSTRUMENTE GERMANY

Wundhaken
Retractors
Separadores
Divaricatori

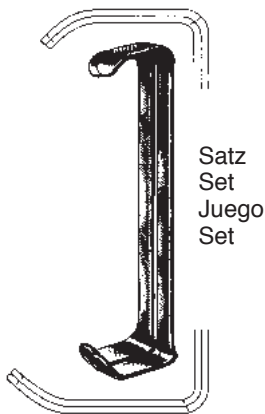

Satz
Set
Juego
Set

FARABEUFG
19102-12
12 cm, 4³/₄"

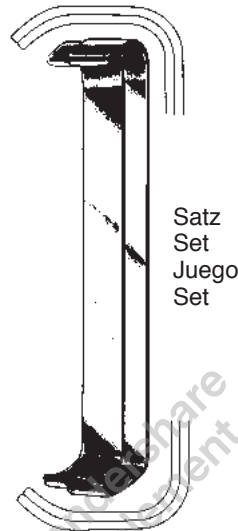

Satz
Set
Juego
Set

FARABEUFG
19102-15
15 cm, 6"

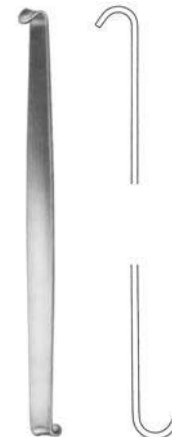

ROUX mini
19124-15
14 cm, 5¹/₂"



8x4 mm

15x5,5 mm

RAGNELL
19125-14
14 cm, 5¹/₂"

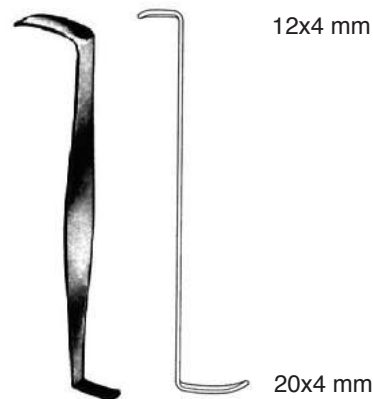

12x4 mm

20x4 mm

CRILE
19127-11
13 cm, 5¹/₈"

HADEO
INSTRUMENTE GERMANY

Bauch- und Darmspatel, biegsam
Abdominal and Intestinal Spatulas, malleable
Espátulas abdominales e intestinales, maleables
Spatole addominali e intestinali, malleabili



RIBBON

19168-06	6x200 mm
19168-08	8x200 mm
19168-10	10x200 mm
19168-12	12x200 mm
19168-17	17x200 mm
19168-20	20x200 mm
19168-25	25x200 mm
19169-25	25x250 mm



RIBBON

19170-20	20x330 mm
19170-25	25x330 mm
19170-32	32x330 mm
19170-40	40x330 mm
19170-45	45x330 mm
19170-50	50x330 mm
19170-65	65x330 mm
19170-76	76x330 mm

HADEO
INSTRUMENTE GERMANY

Wundhaken
Retractors
Separadores
Divaricatori



19 mm

DEAVER
19180-19
19 cm, 7½"



22 mm

DEAVER
19181-22
21,5 cm, 8½"

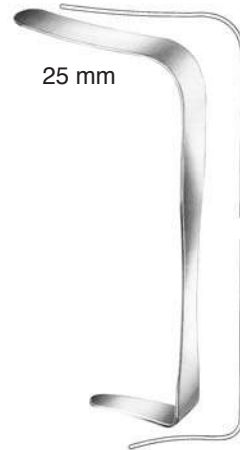

25 mm

DEAVER
19181-25
23 cm, 9"



25 mm

DEAVER
19183-25
30 cm, 11¾"



25 mm

DEAVER
19185-25
33 cm, 13"



25 mm

DEAVER
19187-25
36 cm, 14"

HADEO
INSTRUMENTE GERMANYWundhaken
Retractors
Separadores
DivaricatoriFREEMAN
19188-12
20 cm, 8", 12 mm wideFREEMAN
19188-12CL
20 cm, 8", 12 mm widemit Kaltlicht + Absaugung
with cold light + aspiration
con luz fria + aspiración
con luce fredda + aspirazione

Feine Wundhaken
Retractors
Separadores
Divaricatori



GRAEFE
19210-12

scharf
sharp
agudo
acuto



GRAEFE
19211-12

stumpf
blunt
romo
smusso



GUTHRIE
19212-01

scharf
sharp
agudo
acuto



12 cm, 4³/₄"



TYRELL
19213-12
12 cm, 4³/₄"

scharf
sharp
agudo
acuto

HADEO
INSTRUMENTE GERMANY

Feine Wundhaken
Retractors
Separadores
Divaricatori



FRAZIER

A	B
scharf	stumpf
sharp	blunt
agudo	romo
acuto	smusso

A 19214-13	13 cm, 5 1/8"
A 19214-18	18 cm, 7"

B 19215-13	13 cm, 5 1/8"
B 19215-18	18 cm, 7"



LAHEY
12 cm, 4 3/4"

19215-01

19215-02

19215-03



JOSEPH
16 cm, 6 1/4"

19216-01
1 mm

19216-02
2 mm

19216-07
7 mm

19216-05
5 mm

19216-10
10 mm

19217-03

19217-05

19217-07

KLEINERT-KUTZ
13 cm, 5 1/8"

HADEO
INSTRUMENTE GERMANY

Feine Wundhaken
Retractors
Separadores
Divaricatori



BARSKY
19218-01
15 cm, 6"



BARSKY
19218-02
15 cm, 6"



HUMBY
19218-11
11,5 cm, 4 1/2"

HADEO
INSTRUMENTE GERMANY

Wundhaken
Retractors
Separadores
Divaricatori

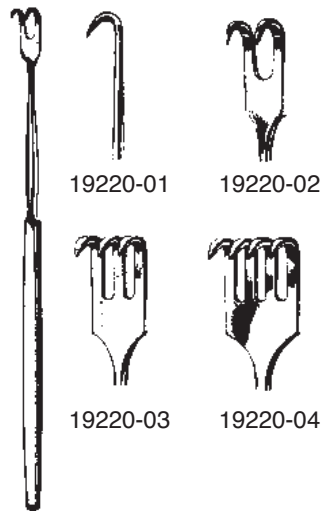

HADEO
16 cm, 6 1/4"

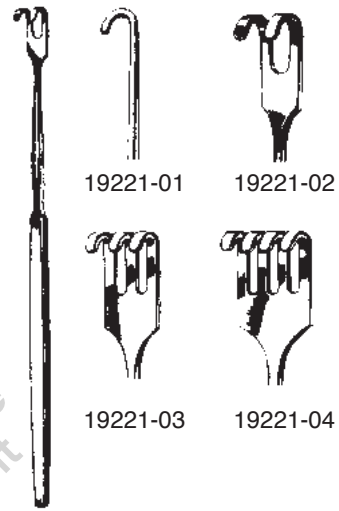

HADEO
16 cm, 6 1/4"

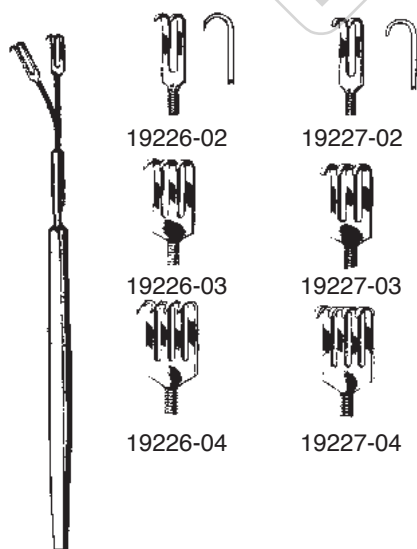

Hadeo, flexibel
16 cm, 6 1/4"



KLAPP
17,5 cm, 6.9"

HADEO
INSTRUMENTE GERMANY

Wundhaken
Retractors
Separadores
Divaricatori



DESMARRES
19230-00 16 cm, 6 1/4"

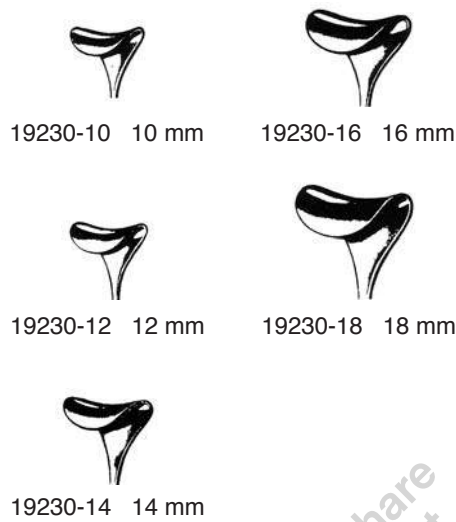

DESMARRES
19234-00 14 cm, 5 1/2"

8 mm

10 mm



KASDAN
19237-16 16 cm, 6 1/4"



VOLKMANN
11,5 cm, 4 1/2"

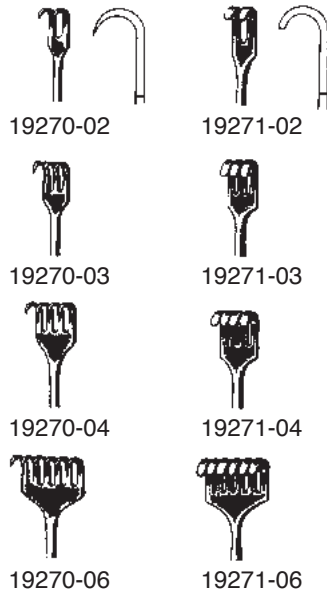

HADEO

INSTRUMENTE GERMANY

Wundhaken
Retractors
Separadores
Divaricatori



MEYERDING
18 cm, 7"



STRANDELL-STILLE
17 cm, 6³/₄"



HADEO
INSTRUMENTE GERMANY

Wundsperrer
Retractors
Separadores
Divaricatori

3x4



spitz
sharp
agudo
acuto

stumpf
blunt
romo
smusso

19610-07 **FINSEN** 7 cm, 2³/₄" 19611-07

4x4



spitz
sharp
agudo
acuto

stumpf
blunt
romo
smusso

19620-07 **ALM** 7 cm, 2³/₄" 19621-07
19620-10 10 cm, 4" 19621-10

3x3



spitz
sharp
agudo
acuto

stumpf
blunt
romo
smusso

19630-10 **JANZEN** 10 cm, 4" 19631-10

4x4



spitz
sharp
agudo
acuto

stumpf
blunt
romo
smusso

19634-10 **HOLZHEIMER** 10 cm, 4" 19635-10

HADEO
INSTRUMENTE GERMANY

Wundsperrer
Retractors
Separadores
Divaricatori

2x3
spitz
sharp
agudo
acuto
stumpf
blunt
romo
smusso

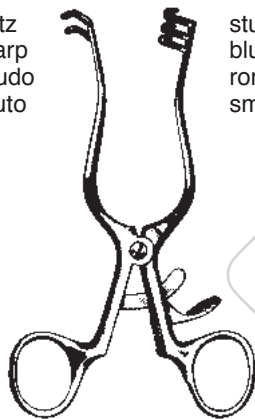

WEITLANER
19650-10 11,5 cm, 4 1/2" 19651-10

3x4
spitz
sharp
agudo
acuto
stumpf
blunt
romo
smusso

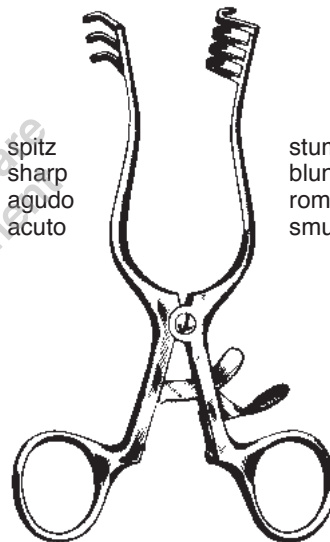

WEITLANER
19670-14 14 cm, 5 1/2" 19671-14

Endo Dissektoren
Endo dissectors
Disectores
Dissettori



24 cm, 9 1/2"



- 19741-01 LANGENBECK, 5,0 mm
- 19741-02 LANGENBECK, 7,0 mm
- 19741-03 LANGENBECK, 10,0 mm



- 19741-04 LANGENBECK, 5,0 mm
- 19741-05 LANGENBECK, 7,0 mm
- 19741-06 LANGENBECK, 10,0 mm



- 19741-07 LANGENBECK, 12,5 mm



- 19741-08 LANGENBECK-COTTLE 7,0 mm



- 19741-09 LANGENBECK-COTTLE, 7,0 mm



- 19741-10 LANGENBECK
konkav, concave, concavo, concavo



- 19741-11 Mini-LANGENBECK



Nervenhaken / nerve hook
gancho para nervios / uncino p. nervi

- 19741-12 links / left / izquierda / sinistra
- 19741-13 rechts / right / derecha / destra

HADEO

INSTRUMENTE GERMANY

Wundhaken für plastische Chirurgie
 Retractors for plastic surgery
 Separadores para cirugía plástica
 Divaricatore per chirurgia plastica



mit Kaltlicht + Absaugung
 with cold light + aspiration
 con luz fria + aspiracion
 con luce fredda + aspirazione

FERRIERA

19960-01	80 mm x 16 mm
19960-02	100 mm x 25 mm
19960-03	120 mm x 25 mm
19960-04	120 mm x 30 mm
19960-05	150 mm x 25 mm
19960-06	150 mm x 30 mm

TEBBETTS

19980-01	80 mm x 16 mm
19980-02	100 mm x 25 mm
19980-03	120 mm x 25 mm
19980-04	120 mm x 30 mm
19980-05	150 mm x 25 mm
19980-06	150 mm x 30 mm

Wundhaken für plastische Chirurgie
Retractors for plastic surgery
Separadores para cirugía plástica
Divaricatore per chirurgia plastica



BREAST
19970-01 26 cm, 10 1/4"



CORONAL
19980-18 18 cm, 7"



YANKOSKIE
19990-18 18 cm, 7"



YANCOSKIE
19991-18
23 cm, 9", 150 mm wide



FREEMAN
19995-22
18 cm, 7", 22 mm
19995-38
18 cm, 7", 38 mm wide

3 Finger
3 prongs
3 dientes
3 rebbi



5 Finger
5 prongs
5 dientes
5 rebbi

ANDERSON
19998-03 12 cm, 4 3/4" 19998-05

HADEO
INSTRUMENTE GERMANY

Spatel
Spatula
Espatula
Spatola

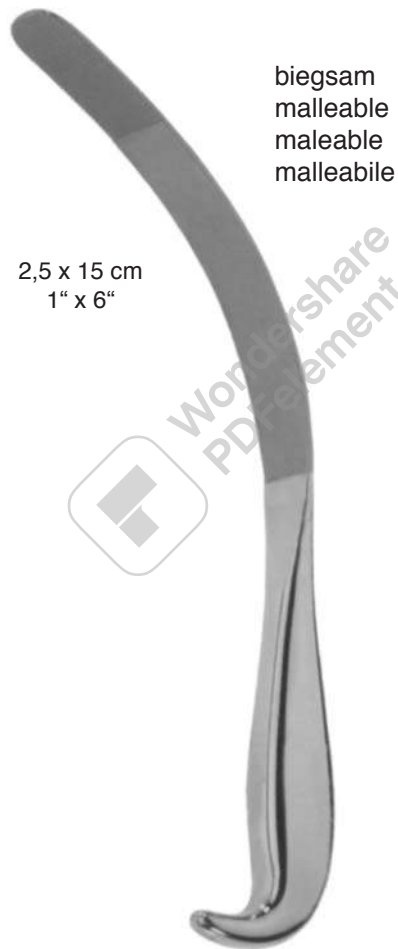

19992-31
31,5 cm, 12¹/₂"

HADEO
INSTRUMENTE GERMANY

Wundhaken für plastische Chirurgie
Retractors for plastic surgery
Separadores para cirugía plástica
Divaricatore per chirurgia plastica



GORNEY
19996-04
7,5 cm, 3", 38 mm



FREEMAN
19997-09
9 cm, 3 1/2", 20 mm

HADEO
INSTRUMENTE GERMANY

Brustdissektoren
Breast Dissectors
Separadores mamarios
Separatori mammari



AGRIS-DINGMAN
19999-00 36 cm, 14"

HADEO
INSTRUMENTE GERMANYBrustdissektoren
Breast Dissectors
Separadores mamarios
Separatori mammari

MacCOLLUM-DINGMAN
19999-01
41 cm, 16"



TEBBETTS
19999-02
33 cm, 13"



TEBBETTS
19999-03
33 cm, 13"



SILVERSTEIN
19999-04
35,6 cm, 14"

HADEO
INSTRUMENTE GERMANY

Wundhaken für plastische Chirurgie
Retractors for plastic surgery
Separadores para cirugía plástica
Divaricatore per chirurgia plastica

**BIGGS**

19999-30 30 mm
19999-50 50 mm

19999-30 CL 30 mm
19999-50 CL 50 mm

CL = mit Kaltlicht + Absaugung
with cold light + aspiration
con luz fria + aspiracion
con luce fredda + aspirazione

HADEO
INSTRUMENTE GERMANY

Nervenhaken, Durahaken
Nerve Hooks, Dura Hooks
Ganchos para nervios y para duramadre
Unicini per nervi e per dura-madre



CRILE
41054-20
20 cm, 8"

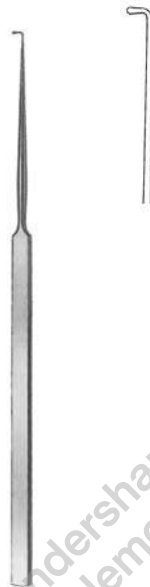

CUSHING
41056-18
18 cm, 7"



CUSHING
41058-18
18 cm, 7"



scharf
sharp
agudo
acuto

ADSON
41068-20
20 cm, 8"



stumpf
blunt
romo
smusso

ADSON
41069-20
20 cm, 8"

HADEO
INSTRUMENTE GERMANY

Feine Wundhaken
Retractors
Separadores
Divaricatori



spitz
sharp
agudo
acuti

O'CONNOR
43370-12
12 cm, 4³/₄"



spitz
sharp
agudo
acuti

WIENER
43372-13
13 cm, 5¹/₈"



stumpf
blunt
romo
smussi

WIENER
43373-13
13 cm, 5¹/₈"

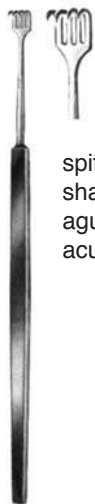

spitz
sharp
agudo
acuti

ROLLET
43376-13
13,5 cm, 5¹/₄"

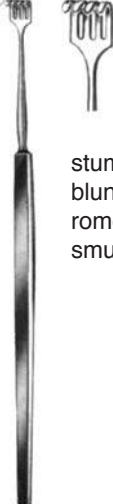

stumpf
blunt
romo
smussi

KNAPP
43377-13
13 cm, 5¹/₈"

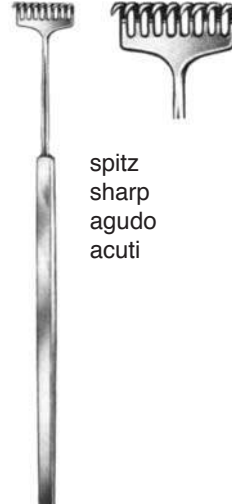

spitz
sharp
agudo
acuti

MILLER
43378-13
13 cm, 5¹/₈"

HADEO
INSTRUMENTE GERMANY

Nasenhaken
Nasal retractors
Separadores nasales
Retrattori nasali



CONVERSE

- 47538-01 9 cm, 3 1/2" 18 x 9,5 mm
- 47538-02 9 cm, 3 1/2" 28 x 12,5 mm
- 47538-03 9 cm, 3 1/2" 41 x 13,5 mm
- 47538-04 9 cm, 3 1/2" 53 x 13,5 mm

COTTLE

- 47540-16
16 cm, 6 1/4"

MALINIAC

- 47550-11
11 cm, 4 3/8"



AUFRICHT
47551-16
16 cm, 6 1/4"

AUFRICHT
47551-16L
16 cm, 6 1/4"

MASING-NEIVERT
47552-16
16 cm, 6 1/4"

COTTLE
47553-15
15 cm, 6"

10 x 12 mm

HADEO
INSTRUMENTE GERMANY

Hauthäkchen, Nasenhaken
Skin hook, Nasal retractors
Gancho para piel, Separadores nasales
Uncino per pelle, Retrattori nasali



COTTLE
14,5 cm, 5³/₄"

3 x 11 mm



KILNER
47555-08 8 cm, 3¹/₈"



FOMON
47556-16 16 cm, 6¹/₄"



FOMON
47557-17 17 cm, 6³/₄"



FREER
47558-15 15 cm, 6"



COTTLE-NEIVERT
47559-20 20 cm, 8"

HADEO
INSTRUMENTE GERMANY

Feine Wundhaken
Retractors
Separadores
Divaricatori



Fig. 1
47560-18



Fig. 2
47562-18

GILLIES
18 cm, 7"



LANGE
47563-22 23 cm, 9"



COTTLE
47564-16 16 cm, 6 1/4"



CONVERSE
47566-12 12 cm, 4 3/4"



MARTINEZ-KILNER
47567-11 11 cm, 4 3/8"

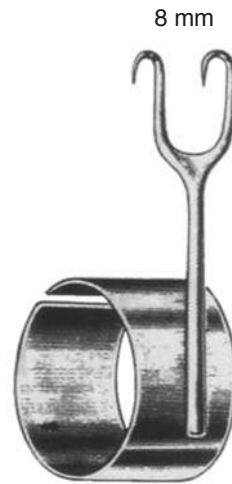

COTTLE
47568-08

HADEO
INSTRUMENTE GERMANY

Trachealhaken
Trachea Hooks
Ganchos para traqueotomía
Ganci per tracheotomia



JACKSON
55116-15
15 cm, 6"



JACKSON
55117-17
17 cm, 6³/₄"



NEWS
55120-15
15 cm, 6"

HADEO
INSTRUMENTE GERMANY

Nadelhalter
Needle Holders
Porta-agujas
Portaghi



DERF
25110-12 12 cm, 4³/₄" **25114-12 TC**

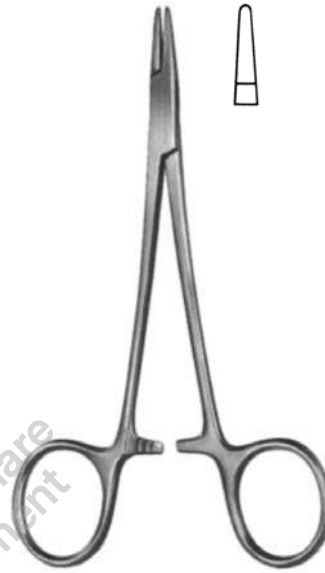

WEBSTER
25128-13 13 cm, 5¹/₈"
25129-13 TC 13 cm, 5¹/₈"



HALSEY
25130-13 13 cm, 5¹/₈" 25140-13
25134-13 TC 13 cm, 5¹/₈" 25144-13 TC

HADEO
INSTRUMENTE GERMANY

Nadelhalter
Needle Holders
Porta-agujas
Portaghi



BAUMGARTNER

- | | | |
|----------|-----------------|-------------|
| 25150-12 | 12,5 cm, 5" | 25154-12 TC |
| 25150-14 | 14,0 cm, 5 1/2" | 25154-14 TC |



CRILE-WOOD

- | | | |
|----------|-----------|-------------|
| 25160-15 | 15 cm, 6" | 25164-15 TC |
| 25160-18 | 18 cm, 7" | 25164-18 TC |
| | 20 cm, 8" | 25164-20 TC |
| | 23 cm, 9" | 25164-23 TC |



MAYO-HEGAR

- | | | |
|----------|---------------|-------------|
| 25180-12 | 12 cm, 4 3/4" | 25184-12 TC |
| 25180-14 | 14 cm, 5 1/2" | 25184-14 TC |
| 25180-16 | 16 cm, 6 1/4" | 25184-16 TC |
| 25180-18 | 18 cm, 7" | 25184-18 TC |
| 25180-20 | 20 cm, 8" | 25184-20 TC |



DeBAKEY

- | | |
|-------------|---------------|
| 25214-16 TC | 16 cm, 6 1/4" |
| 25214-18 TC | 18 cm, 7" |
| 25214-20 TC | 20 cm, 8" |
| 25214-23 TC | 23 cm, 9" |

HADEO
INSTRUMENTE GERMANY

Nadelhalter
Needle Holder
Porta-agujas
Portaghi

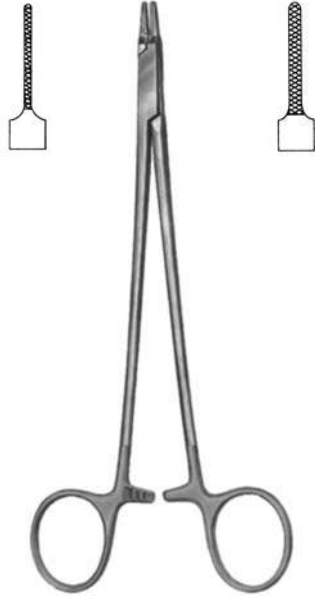

- | | | |
|-------------|---------------|-------------|
| 1 mm | RYDER | 2 mm |
| 25224-13TC | 13 cm, 5 1/8" | 25225-13 TC |
| 25224-15TC | 15 cm, 6" | 25225-15 TC |
| 25224-16TC | 16 cm, 6 1/4" | 25225-16 TC |
| 25224-18TC | 18 cm, 7" | 25225-18 TC |
| 25224-20TC | 20 cm, 8" | 25225-20 TC |

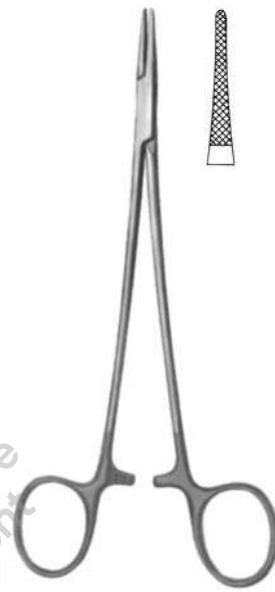

- | | |
|----------------------|-----------|
| MICROVASCULAR | |
| 25230-18TC | 18 cm, 7" |
| 25230-20TC | 20 cm, 8" |



- | | | |
|-------------------------|---------------|------------|
| BABY OLSEN-HEGAR | | |
| 25405-12 | 12 cm, 4 3/4" | 25406-12 |
| 25408-12TC | 12 cm, 4 3/4" | 25407-12TC |

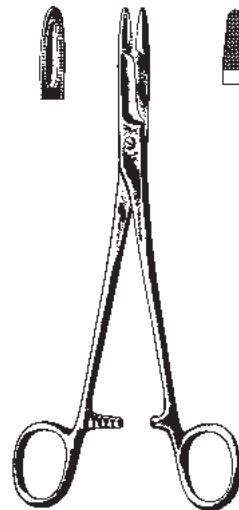

- | | | |
|--------------------|---------------|------------|
| OLSEN-HEGAR | | |
| 25410-14 | 14 cm, 5 1/2" | 25414-14TC |
| 25410-17 | 17 cm, 6 3/4" | 25414-17TC |
| | 18 cm, 7" | 25414-18TC |

HADEO
INSTRUMENTE GERMANY

Nadelhalter
Needle Holders
Porta-agujas
Portaghi

**GILLIES**

25434-11TC	11 cm, 4 ³ / ₈ "
25434-13TC	13 cm, 5 ¹ / ₈ "
25434-16TC	16 cm, 6 ¹ / ₄ "

HADEO
INSTRUMENTE GERMANY

Mikro-Nadelhalter
Micro Needle Holders
Micro-porta-agujas
Micro portaghi

ohne Sperre
without lock
sin cremallera
senza cremagliera

mit Sperre
with lock
con cremallera
con cremagliera



11,5 cm, 4 1/2"
13,0 cm, 5 1/8"
14,0 cm, 5 1/2"
18,0 cm, 7"
21,0 cm, 8 1/4"
23,0 cm, 9"

25660-12
25660-13
25660-14
25700-18

25661-12
25661-13
25661-14
25701-18

25720-12
25720-13
25720-14
25730-18
25730-21
25730-23

25731-12
25731-13
25731-14
25731-18
25731-21
25731-23

mit diamantiertem Maul
with diamond jaw
con boca de diamante
con morso diamantato

11,5 cm, 4 1/2"
13,0 cm, 5 1/8"
14,0 cm, 5 1/2"
18,0 cm, 7"
21,0 cm, 8 1/4"
23,0 cm, 9"

25720-12D
25720-13D
25720-14D
25730-18D
25730-21D
25730-23D

25671-12D
25671-13D
25671-14D
25731-18D
25731-21D
25731-23D

T= Titan, titanium, titanio, titanio



15,0 cm, 6"
18,0 cm, 7"
21,0 cm, 8 1/4"

93250-15T
93250-18T
93250-21T

93251-15T
93251-18T
93251-21T

93260-15T
93260-18T
93260-21T

93261-15T
93261-18T
93261-21T



BARRAQUER

HADEO
INSTRUMENTE GERMANY

Mikro-Nadelhalter mit Sperre
Micro Needle Holders, with lock
Micro-porta-agujas con cremallera
Micro portaghi, con cremagliera



CASTROVIEJO



14,0 cm, 5 1/2"
18,0 cm, 7"
21,5 cm, 8 1/2"
23,0 cm, 9"

25670-14
25670-18
25670-21

25671-14
25671-18

25672-14
25672-18
25672-21
25672-23

25673-14
25673-18

mit TC 1,4 mm
with TC jaw 1,4 mm
con TC 1,4 mm
con morso in TC 1,4 mm

14,0 cm, 5 1/2"
18,0 cm, 7"
21,5 cm, 8 1/2"
23,0 cm, 9"

25674-14
25674-18
25674-21

25675-14
25675-18

25676-14
25668-18
25668-21
25668-23

25677-14
25691-18

mit diamantiertem Maul 0,8 mm
with diamond jaw 0,8 mm
con boca de diamante 0,8 mm
con morso diamantato 0,8 mm

14,0 cm, 5 1/2"
18,0 cm, 7"
21,5 cm, 8 1/2"
23,0 cm, 9"

25672-14D
25672-18D
25672-21D
25672-23D

25673-14D
25673-18D

T= Titan, titanium, titanio, titanio
Maul/jaw/boca/morso 0,4mm

14,0 cm, 5 1/2"
18,0 cm, 7"
21,5 cm, 8 1/2"

25672-14T
25672-18T
25672-21T

25673-14T
25673-18T
25673-21T

HADEO
INSTRUMENTE GERMANY

Drahtzangen
Wire Twisting Forceps
Pinza para torcer hilos
Pinza torcifili



MAYO-HABERISSER TC

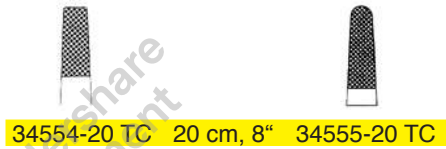
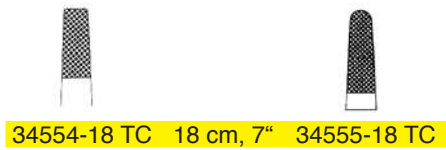
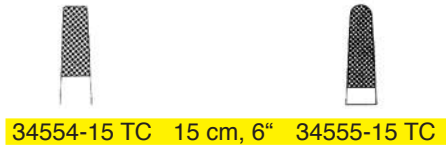

BERRY TC
34556-18TC 18 cm, 7"

HADEO
INSTRUMENTE GERMANY

Hohlmeißelzange
Bone Rongeurs
Pinzas-gubias
Pinze sgorbie

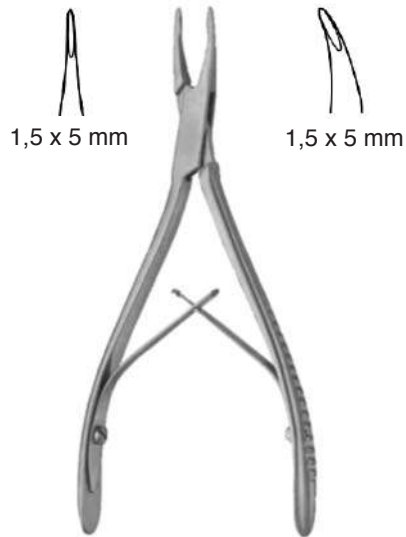

MICRO FRIEDMANN
33100-01 14,5 cm, 5³/₄" 33100-02



FRIEDMANN MINI
33101-12 12 cm, 4³/₄"



FRIEDMANN
33101-14 14 cm, 5¹/₂"



BEYER
33201-18 18 cm, 7"

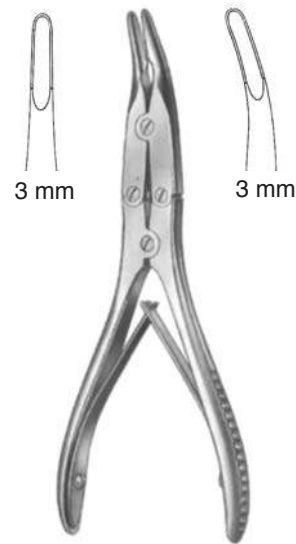

BÖHLER
33211-15 15 cm, 6" 33213-15

HADEO
INSTRUMENTE GERMANY

Knochensplitterzangen
Bone Cutting Forceps
Pinzas cortantes para huesos
Cesoie per ossa



BÖHLER
33280-15 15 cm, 6"



BÖHLER
33281-15 15 cm, 6"



COTTLE-KAZANJIAN
33282-19 19 cm, 7½"



MC INDOE
33283-17 17 cm, 6¾"

HADEO
INSTRUMENTE GERMANY

Hämmer
Bone Mallets
Martillos
Martelli

Ø 25 mm



GERZOG
33686-25
18 cm, 7" 250g

Ø 25 mm



33694-01 18,5 cm, 7 1/4", 135 g
33694-03 Ersatzbacken
Nylon Caps
Tapas de repuesto
Placche di ricambio

Ø 25 mm



33694-02 18,5 cm, 7 1/4"
mit Nylonbacke
with nylon tap
con tapa de nylon
con placca di nylon

Ø 20 mm



MEAD
33693-32
17 cm, 6 3/4" 320 g

Ø 22 mm



PARTSCH
33698-98
18 cm, 7" 199 g



QUISLING
33696-75
17 cm, 6 3/4"

Ø 30 mm



COTTLE
33700-05
18 cm, 7" 240 g

HADEO
INSTRUMENTE GERMANY

Elevatoren, Raspatoren
Elevators, Raspatories
Elevadores, Legras
Elevatori, Periostotomi



LANGENBECK
20 cm, 8"
33711-20 8 mm
33711-21 10 mm



WILLIGER
16 cm, 6 1/4"
33711-16



WILLIGER
16 cm, 6 1/4"
33712-16



WILLIGER
33713-17
16 cm, 6 1/4"



JOSEPH
33718-16
16 cm, 6 1/4"

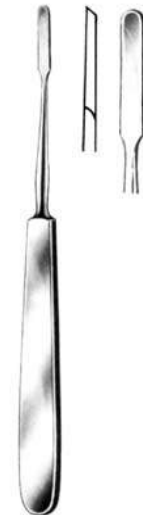

FOMON
33719-17
16 cm, 6 1/4"

HADEO
INSTRUMENTE GERMANY

Elevatoren, Raspatoren
Elevators, Raspatories
Elevadores, Legras
Elevatori, Periostotomi

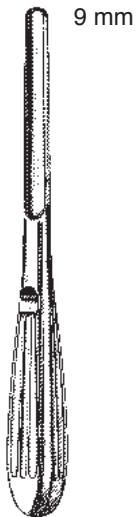

BOIES
33720-19
19 cm, 7½"



GORNEY
33720-21
21 cm, 8¼"

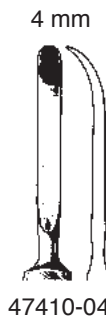

47410-04



McKENTY
15 cm, 6"

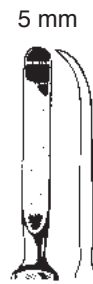

47410-05



JOSEPH
47411-16
16 cm, 6¼"



MASING
47414-21
22 cm, 8¾"



FREER
47415-18
18 cm, 7"



FREER
47417-19
19 cm, 7½"



FREER
47419-19
19 cm, 7½"

HADEO
INSTRUMENTE GERMANY

Elevatoren, Raspatoren
Elevators, Raspatories
Elevadores, Legras
Elevatori, Periostotomi



KILLIAN
47420-01
18,5 cm, 7¹/₄"



PIERCE
47420-02
21 cm, 8¹/₄"

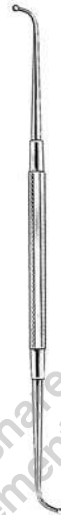

SINUS
47420-03
18 cm, 7"



PENNINGTON
47420-04
21 cm, 8¹/₄"



McKENY
47420-20
22 cm, 8³/₄"



HOWARTH
47421-21
21,5 cm, 8¹/₂"

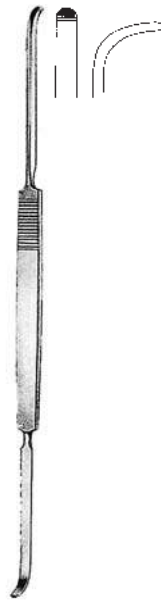

COTTLE
47421-23
23 cm, 9"



COTTLE JOSEPH
47422-22
22 cm, 8³/₄"

HADEO
INSTRUMENTE GERMANY

Elevatoren, Raspatoren
Elevators, Raspatories
Elevadores, Legras
Elevatori, Periostotomi



COTTLE
47423-22 22 cm, 8³/₄"



COTTLE
47424-16 16 cm, 6¹/₄"



COTTLE
47425-19 19 cm, 7¹/₂"



KILLIAN
47426-22 22 cm, 8³/₄"



HAJEK-BALLENGER
47428-21 22 cm, 8³/₄"



BALLENGER
47430-22 22 cm, 8³/₄"

HADEO
INSTRUMENTE GERMANY

Lippen- und Gaumenspaltinstrumente
Lip and Cleft Palate Instruments
Instrumentos para labios y fisura palatina
Strumenti per labbra e fessure del palato

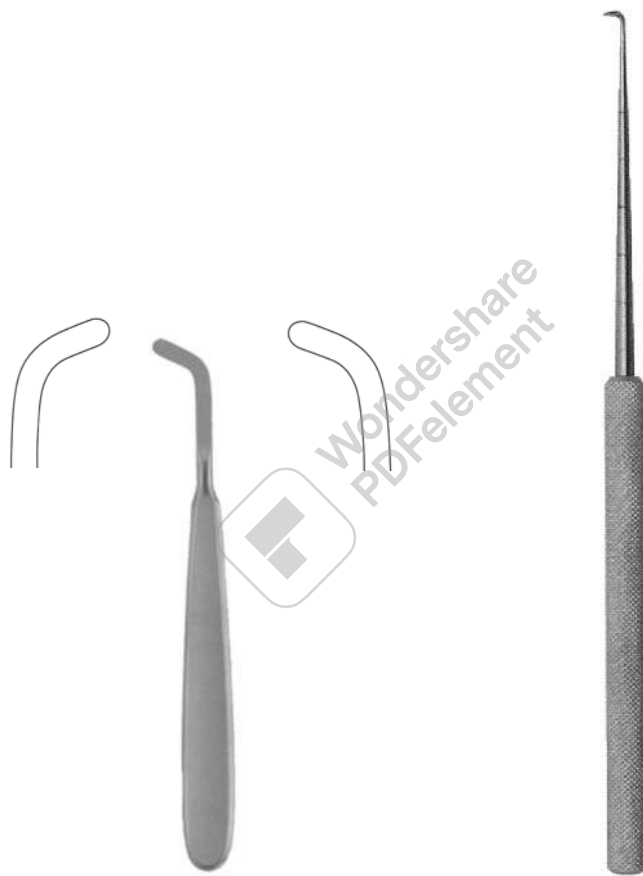

49278-01 14 cm, 5½" 49278-02

CRIONIN
49280-18 18 cm, 7"

HADEO
INSTRUMENTE GERMANY

Lippen- und Gaumenspaltinstrumente
Lip and Cleft Palate Instruments
Instrumentos para labios y fisura palatina
Strumenti per labbra e fessure del palato



BLAIR
49281-01
23 cm , 9"



BLAIR
49281-02
20 cm, 8"

HADEO
INSTRUMENTE GERMANYSaugkanülen
Suction Tubes
Tubos de aspiracion
Cannula aspirante

ADSON
41290-21
20 cm, 8¹/₄"
Ø 4 mm



BARON
41299-03 3FR Ø 1,0 mm
41299-05 5FR Ø 1,6 mm
41299-07 7FR Ø 2,3 mm

Arbeitslänge
working length
largo útil
lunghezza utile
75 mm

HADEO
INSTRUMENTE GERMANY

Saugkanülen
Suction Tubes
Tubos de aspiracion
Cannula aspirante

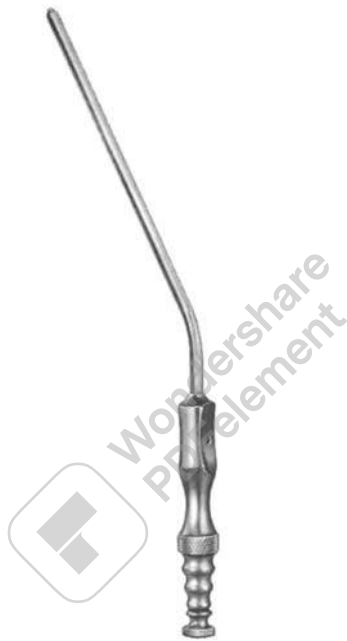

FRAZIER/FERGUSSON
19 cm, 7 1/2"

Charr.

F.G.	Ø	30°	75°
6	2,0 mm	41295-06	41297-06
7	2,3 mm	41295-07	41297-07
8	2,7 mm	41295-08	41297-08
9	3,0 mm	41295-09	41297-09
10	3,3 mm	41295-10	41297-10
11	3,6 mm	41295-11	41297-11
12	4,0 mm	41295-12	41297-12

HADEO
INSTRUMENTE GERMANY

Saugkanülen
Suction Tubes
Tubos de aspiracion
Cannula aspirante

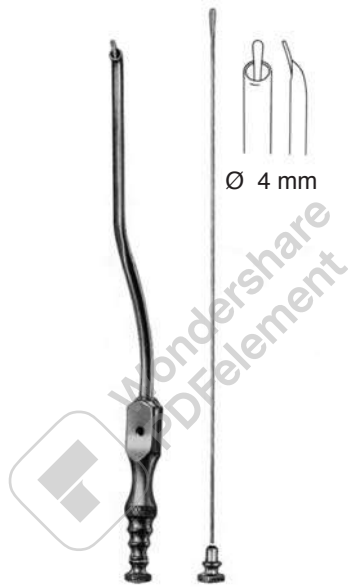

GUILLEN
47347-20
19 cm, 7½"
Ø 4 mm

HADEO
INSTRUMENTE GERMANY

Nasenspekula
Nasal Speculum
Espéculos nasales
Specoli nasali

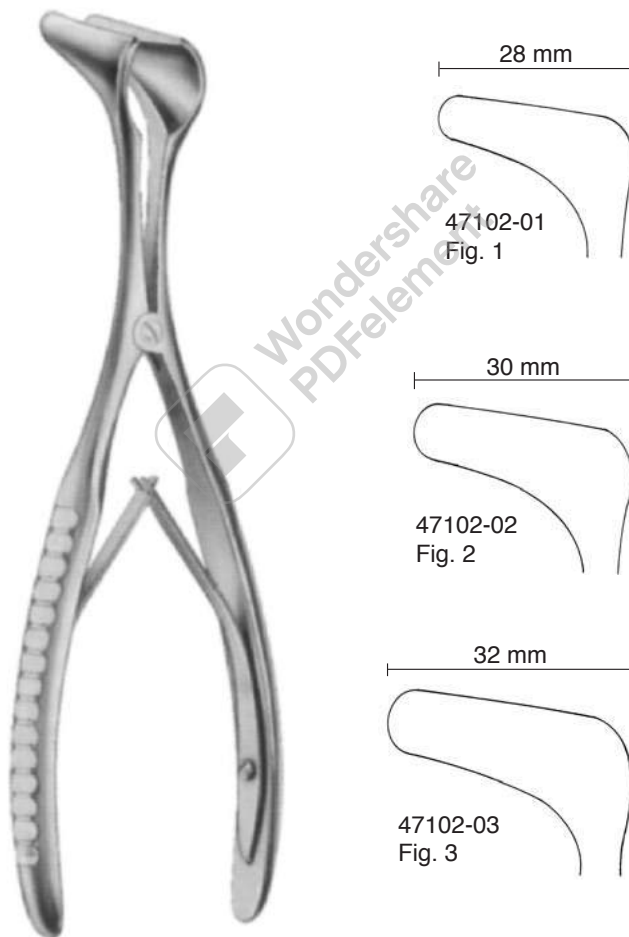

HARTMANN-HALLE
15 cm, 6"

HADEO
INSTRUMENTE GERMANY

Nasenspekula
Nasal Speculum
Espéculos nasales
Specoli nasali

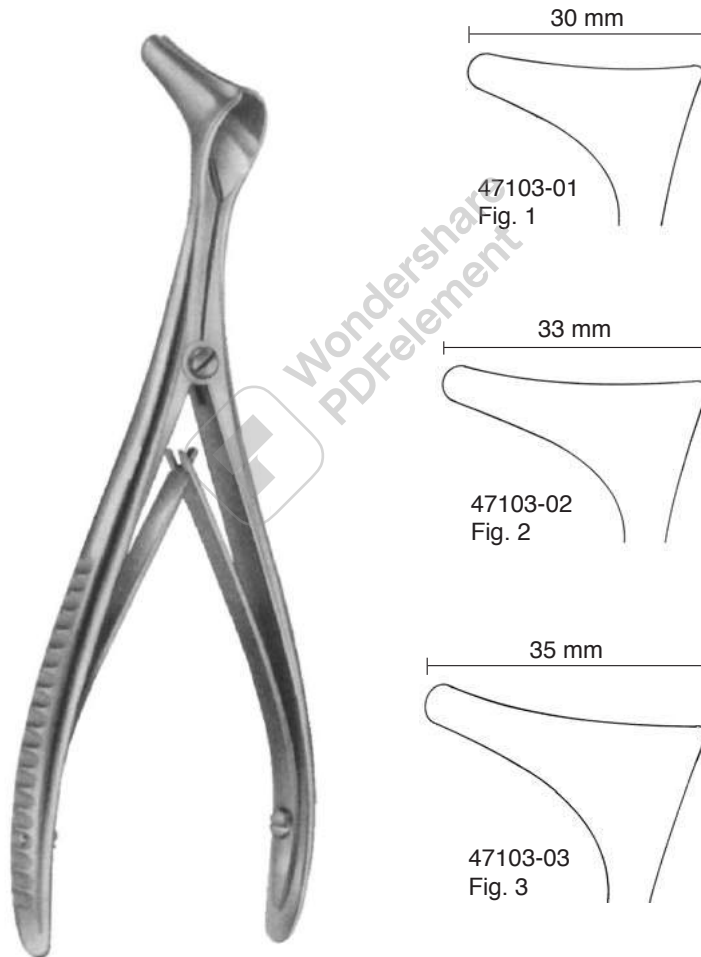

HARTMANN
16 cm, 6 1/4"

HADEO
INSTRUMENTE GERMANY

Nasenspekula
Nasal Speculum
Espéculos nasales
Specoli nasali



Mod. WIEN
14 cm, 5 1/2"

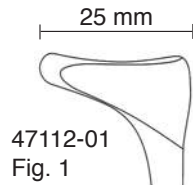

Baby, bebé, neonato

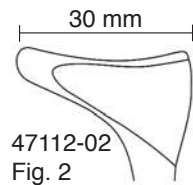

Kind, child, niño, bambino

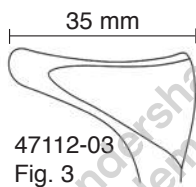

Erwachsene, Adult, adulto



TIECK-HALLE
47116-13
13,5 cm, 5 1/4"

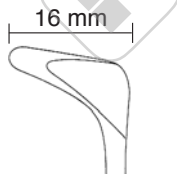

HADEO
47118-13
12,5 cm, 5"

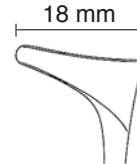

HADEO
INSTRUMENTE GERMANY

Nasenspekula
Nasal Specula
Espéculos nasales
Specoli nasali



KILLIAN
13 cm, 5 1/8"

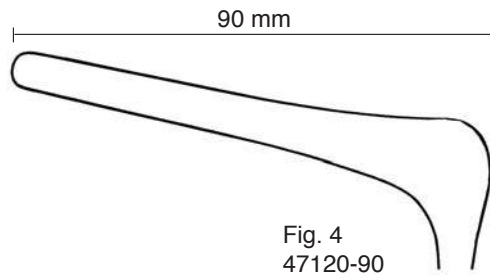
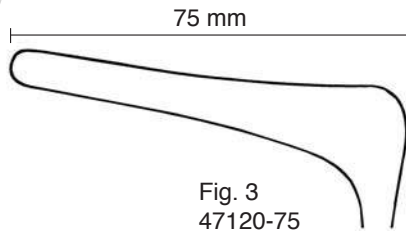
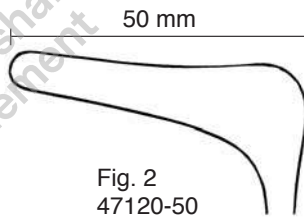
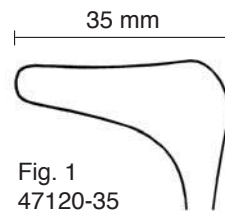

HADEO
INSTRUMENTE GERMANY

Nasenspekula
Nasal Specula
Espéculos nasales
Specoli nasali

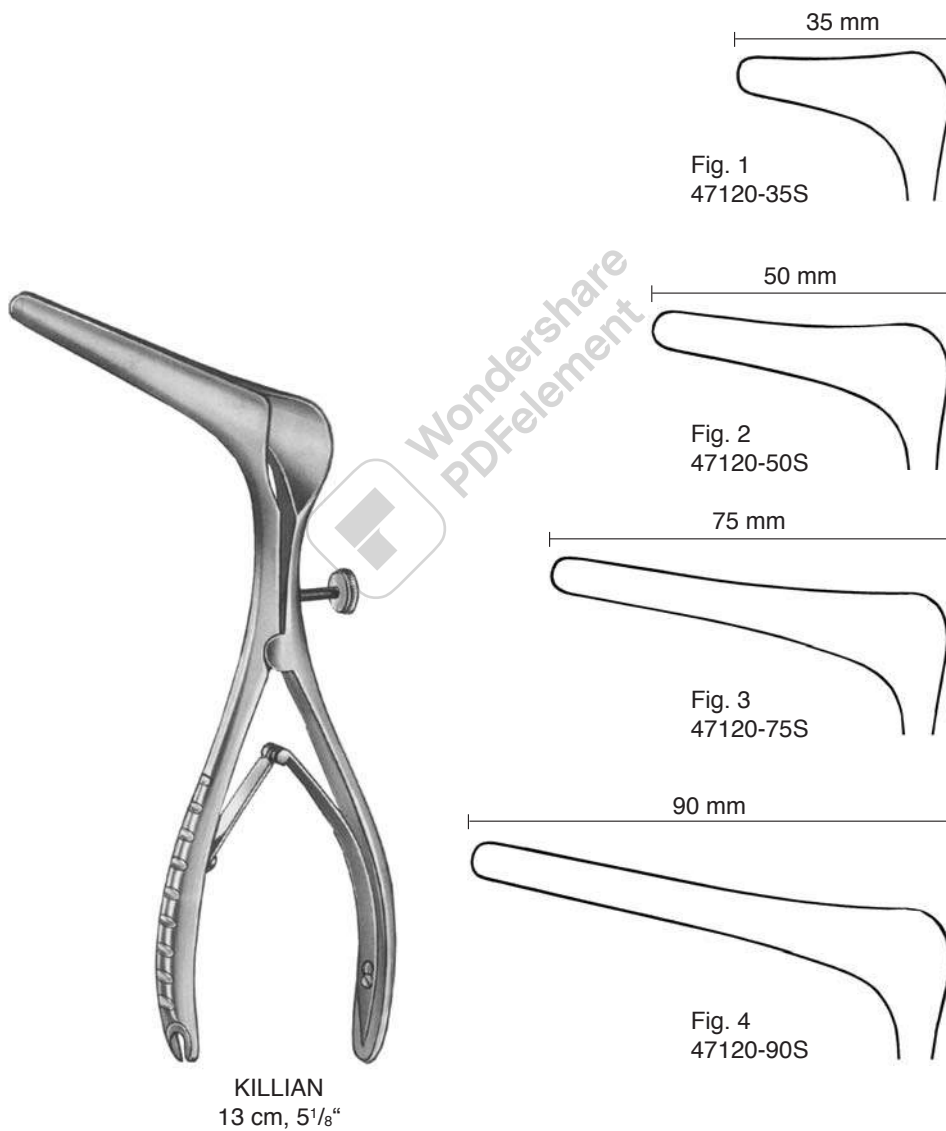

HADEO
INSTRUMENTE GERMANY

Nasenspekula
Nasal Speculum
Espéculos nasales
Specoli nasali

35 mm

Fig. 1
47124-35

50 mm

Fig. 2
47124-50

75 mm

Fig. 3
47124-75

90 mm

Fig. 4
47124-90



COTTLE
14 cm, 5 1/2"

HADEO
INSTRUMENTE GERMANY

Nasenspekula
Nasal Speculum
Espéculos nasales
Specoli nasali

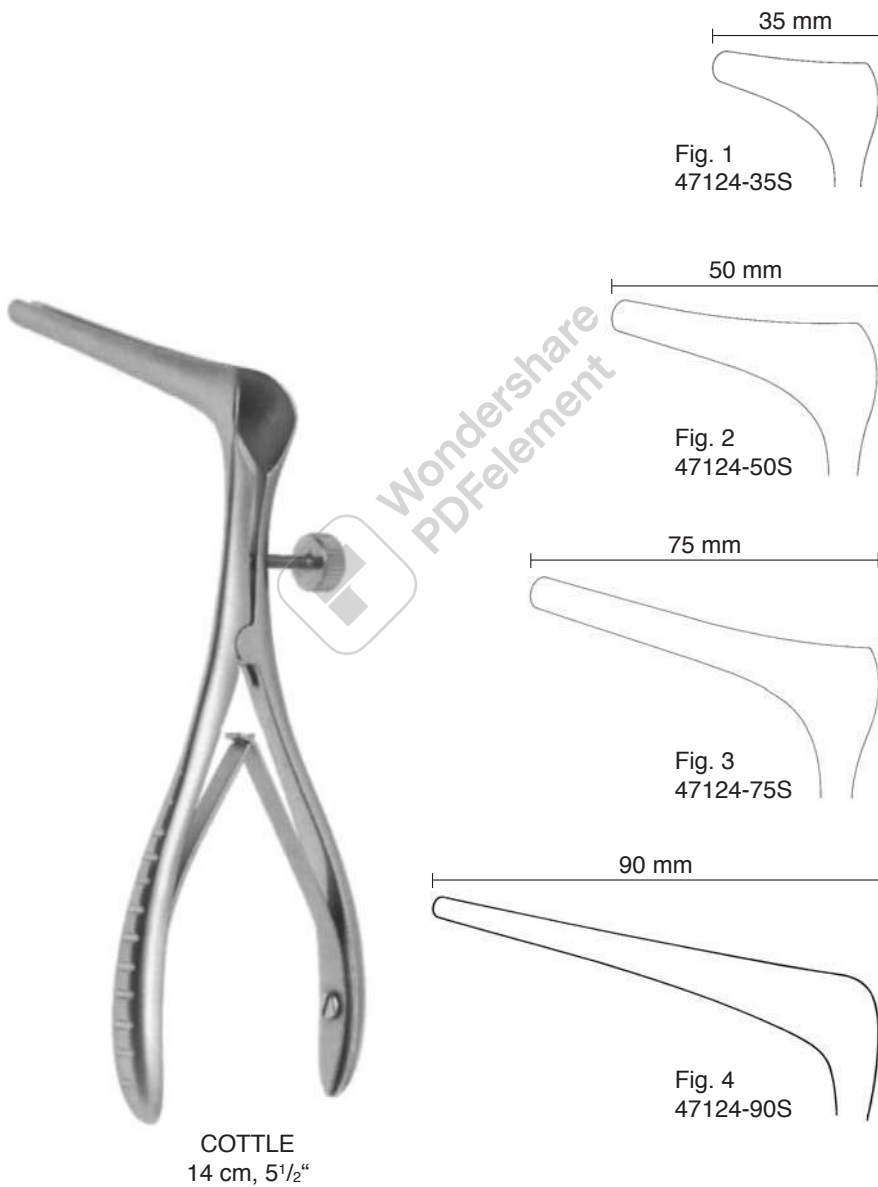

HADEO
INSTRUMENTE GERMANY

Nasentamponzange, Polypenzange
Nasal Tampon Forceps, Ear Polypus Forceps
Pinza para taponamiento, Pinzas para pólipos
Pinze per medicature, Pinze per polipi



WESTMACOTT
47158-20 20 cm, 8"



LUBET-BARBON
47159-20 20 cm, 8"



HARTMANN
47161-16 16 cm, 6 1/4"



HARTMANN
47161-20 20 cm, 8"

HADEO
INSTRUMENTE GERMANY

Polypenzangen, Septumzangen
Nasal Polypus and Septum Forceps
Pinzas para pólipos y para el tabique nasal
Pinze per polipi, Pinze per il setto nasale

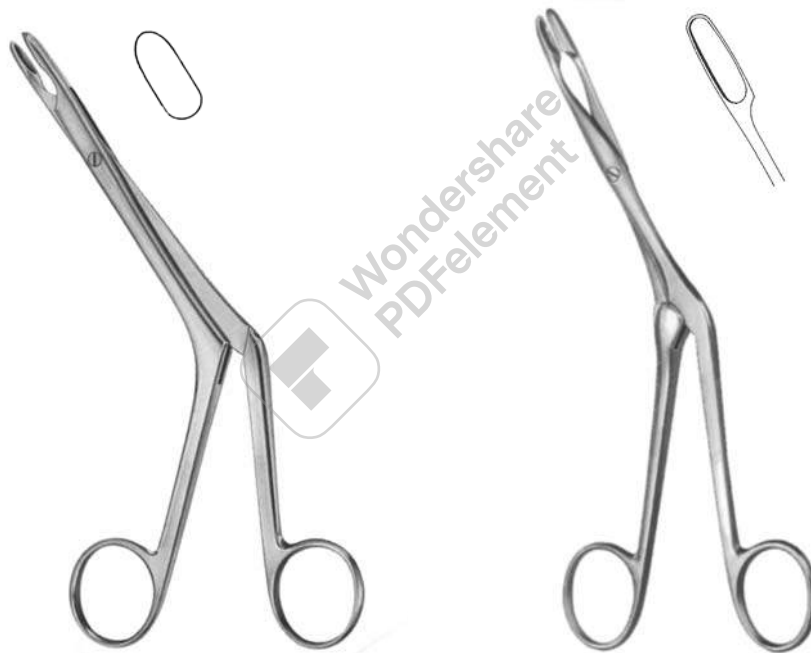

HEYMANN-KNIGHT
47169-18
18 cm, 7"

KNIGHT
47185-18
18 cm, 7"

HADEO
INSTRUMENTE GERMANY

Septumzangen
Septum Forceps
Pinzas para el tabique nasal
Pinze per il setto nasale



47191-01 47191-02

47191-03 47191-04

BRUENINGS
19 cm, 7 1/2"

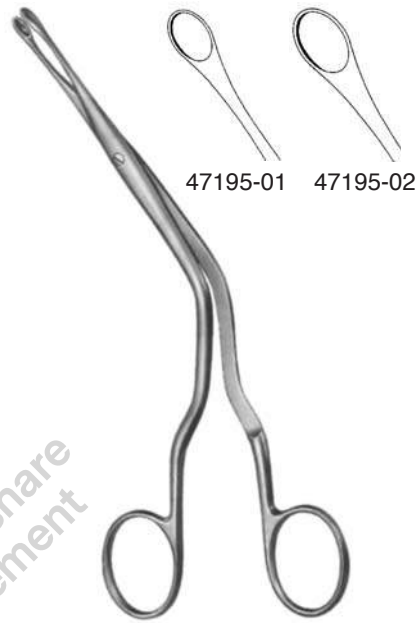

47195-01 47195-02

LUC
19 cm, 7 1/2"



GRAIG
47192-16 16 cm, 6 1/2"

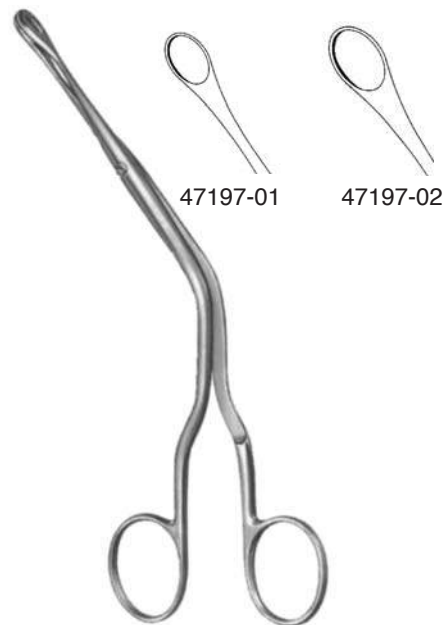

47197-01 47197-02

LUC
19 cm, 7 1/2"

HADEO
INSTRUMENTE GERMANY

Scharfe Nasenzange
Nasal Cutting Forceps
Pinzas cortantes nasales
Pinze taglienti nasali

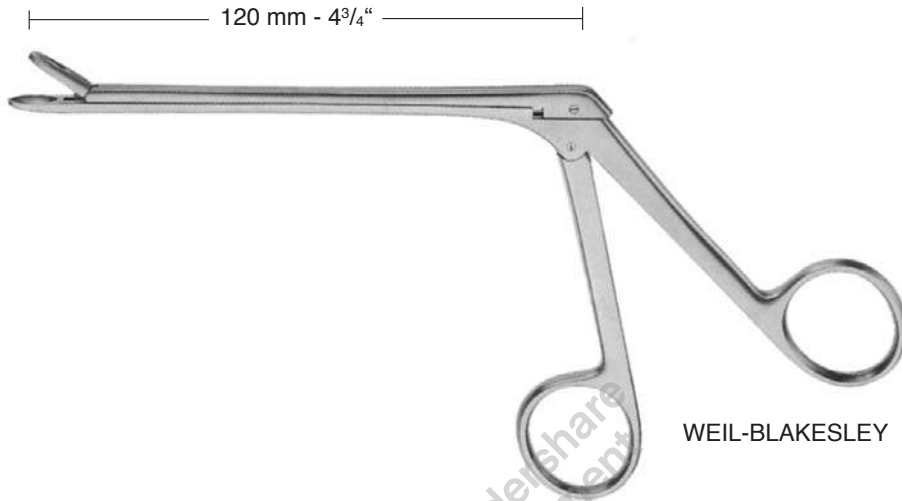
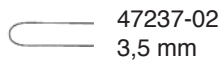
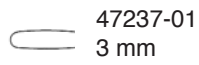

	Fig.1	Fig. 2	Fig.3	Fig.4	Fig. 5
	47223-01 3,0 mm	47223-02 3,6 mm	47223-03 4,2 mm	47223-04 4,8 mm	47223-05 5,8 mm
	47224-01 3,0 mm	47224-02 3,6 mm	47224-03 4,2 mm	47224-04 4,8 mm	47224-05 5,8 mm
	47225-01 3,0 mm	47225-02 3,6 mm	47225-03 4,2 mm	47225-04 4,8 mm	
	47226-01 2,0 mm	47226-02 2,5 mm	47226-03 3,0 mm		
	47227-01 2,0 mm	47227-02 2,5 mm	47227-03 3,0 mm		



Scharfe Nasenzangen
Nasal Cutting Forceps
Pinzas cortantes nasales
Pinze taglianti nasali



47239-01 47239-02



MYLES



SCHMEDEN

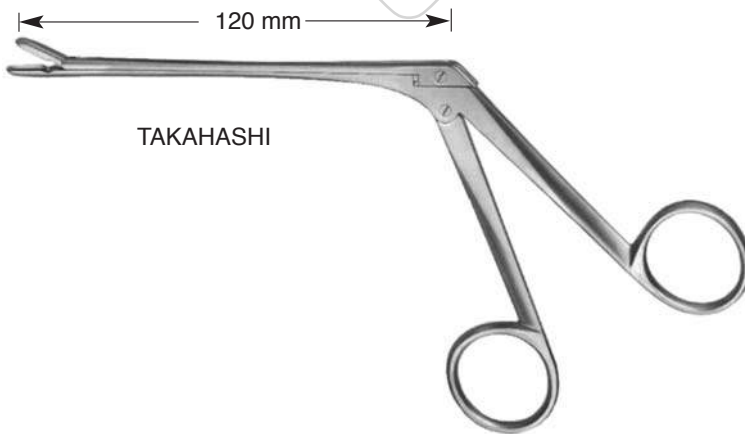

47242-00



47242-01

HADEO
INSTRUMENTE GERMANY

Septumzange, Scharfe Nasenzange
Septum Forcep, Nasal Cutting Forceps
Pinza para el tabique nasal, Pinza cortante nasal
Pinza per setto nasale, pinze taglienti nasali



RUBIN
47251-21
21 cm, 8 $\frac{1}{4}$ "



CAPLAN
47256-20
20 cm, 8"

HADEO
INSTRUMENTE GERMANY

Septumzangen
Septum Forceps
Pinzas para el tabique nasal
Pinze per il setto nasale



MIDDLETON-JANSEN
47323-19
19 cm, 7½"



MIDDLETON-JANSEN
47325-19
19 cm, 7½"

HADEO
INSTRUMENTE GERMANY

Rhinoplastikmesser
Rhinoplasty knives
Cuchillos nasales
bisturi nasale



JOSEPH
16 cm, 6 1/4"

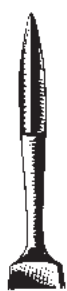

47370-16 47371-16
stumpf, blunt,
romo, smussi



47372-16 47373-16
spitz, pointed,
agudo, acuti



FREER
47374 - 16
16,5 cm, 6 1/2"



JOSEPH
47375 - 16
16 cm, 6 1/4"

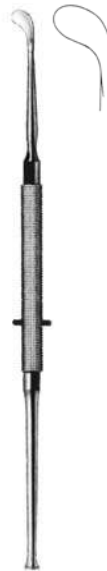

FREER
47375 - 19
19 cm, 7 1/2"



JOSEPH
47376 - 16
16 cm, 6 1/4"

HADEO
INSTRUMENTE GERMANY

Rhinoplastikmesser
Rhinoplasty knives
Cuchillos nasales
bisturi nasale



CONVERSE
47379 - 16
16 cm, 6¹/₄"



COTTLE
47380-15
15 cm, 6"



COTTLE
47382-15
15 cm, 6"



JOSEPH
47384-15
15 cm, 6"



JOSEPH
47385-15
15 cm, 6"



HADEO
19 cm 7¹/₂"



47386-01
spitz
pointed
agudo
acuto



47386-02
stumpf
blunt
romo
smusso

HADEO
INSTRUMENTE GERMANY

Schwingmesser
Septum Swivel Knives
Cuchillos para el tabique nasal
Coltelli per setto



BALLENGER
47390-03 - 47392-05
20 cm, 8"

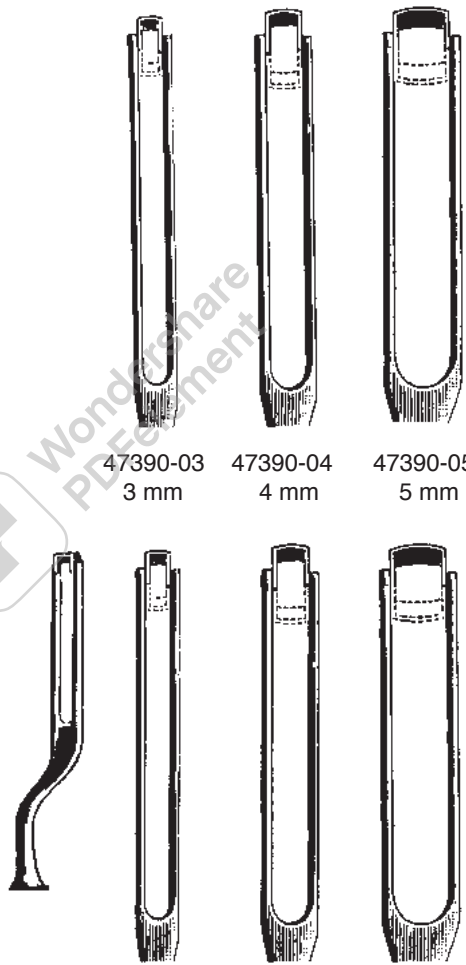

47390-03 3 mm
47390-04 4 mm
47390-05 5 mm

47392-03 3 mm
47392-04 4 mm
47392-05 5 mm

HADEO
INSTRUMENTE GERMANY

Kapselmesser
Capsulotorz knife
Cuchillo para capsula
Coltello per capsula



FOERSTER
47394-27 27 cm, 10¹/₂"

HADEO
INSTRUMENTE GERMANY

Septum Elevatoren
Septum Elevators
Elevadores para el tabique
Elevatori per setto

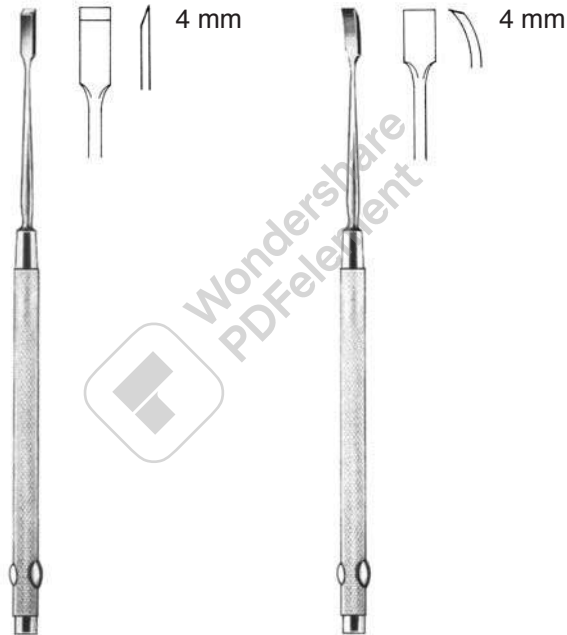

FREER
47450-04
15 cm, 6"

FREER
47451-04
15 cm, 6"

HADEO
INSTRUMENTE GERMANY

Septum Meißel, Osteotome
Rhinoplastic Chisels, Osteotomes
Cinceles para la plástica nasal, Osteotomos
Scalpelli per plastica nasale, Osteotomi

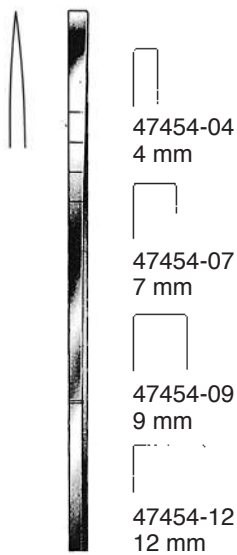

COTTLE
18 cm, 7"



COTTLE
47455-06
18 cm, 7"

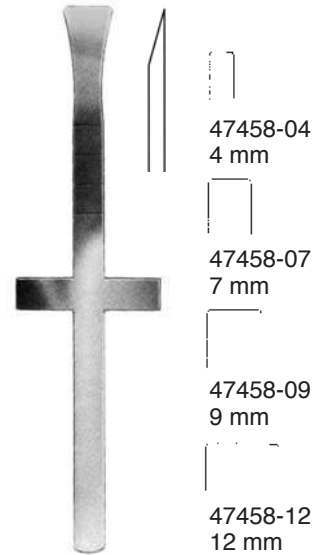

COTTLE
18 cm, 7"

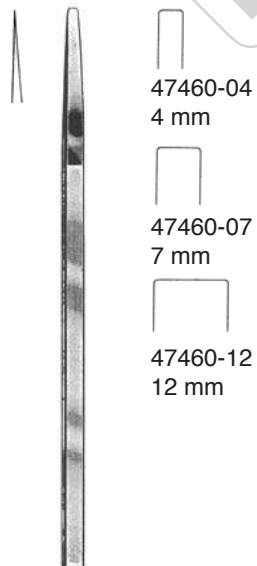

COTTLE
18 cm, 7"

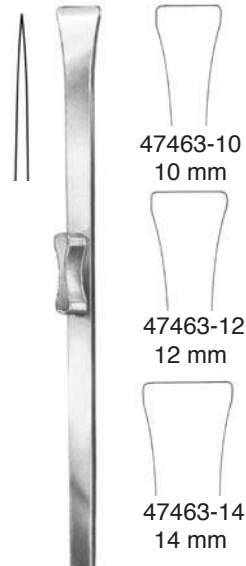

RUBIN
18,5 cm, 7 1/4"

HADEO
INSTRUMENTE GERMANY

Osteotome, Septum Meißel
Osteotomes, Rhinoplastic Chisels
Osteotomo, Cinceles para la plástica nasal
Osteotomi, Scalpelli per plastica nasale

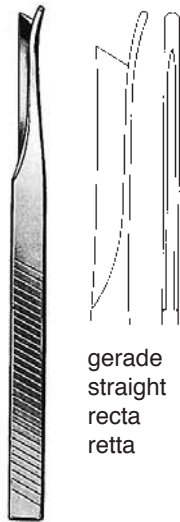

gerade
straight
recta
retta

SILVER
47473-01
18 cm, 7"

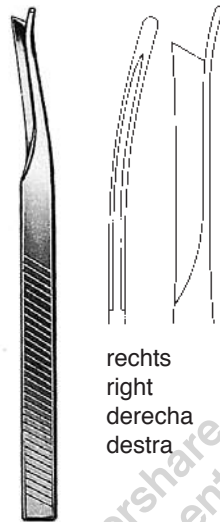

rechts
right
derecha
destra

SILVER
47473-02
18 cm, 7"

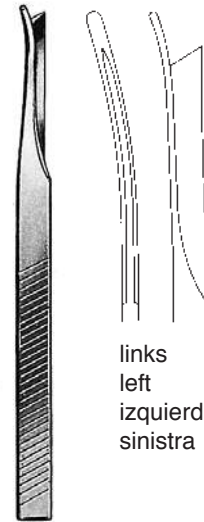

links
left
izquierda
sinistra

SILVER
47473-03
18 cm, 7"



47474-01
rechts
right
derecha
destra

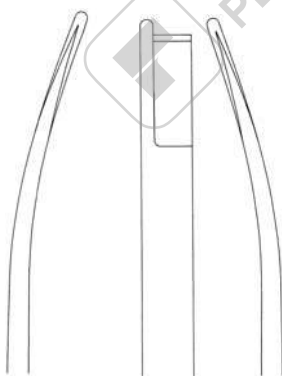

47474-02
links
left
izquierda
sinistra

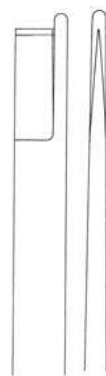

47474-03
gerade
straight
recta
retta

NEIVERT-ANDERSON
20,5 cm, 8" 7 mm



5 mm

KILLIAN
47481-05 16 cm, 6 1/4"

HADEO
INSTRUMENTE GERMANY

Osteotome
Osteotomes
Osteotomo
Osteotomi

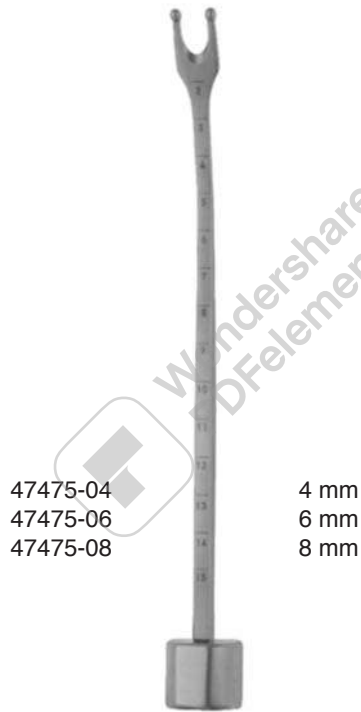

OBWEGESER
18,5 cm, 7¹/₄"

HADEO
INSTRUMENTE GERMANY

Septum Meißel, Osteotome, Hohlmeißel
Rhinoplastic Chisels, Osteotomes, Gouges
Cinceles para la plástica nasal, Osteotomos, Gubias
Scalpelli per plastica nasale, Osteotomi, Sgorbie



KILLIAN-CLAUS
47482-05
17 cm, 6³/₄"



HAJEK mm
47484-04 4
47484-06 6
47484-08 8
16 cm, 6¹/₄"



WEST
47486-16
16 cm, 6¹/₄"



WEST
47487-16
16 cm, 6¹/₄"



FREER
47489-16
16 cm, 6¹/₄"

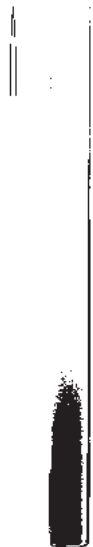

MINI-LAMBOTTE



12,5 cm, 5"	mm	17 cm, 6 ³ / ₄ "
33654-02	2	33652-02
33654-03	3	33652-03
33654-04	4	33652-04
33654-05	5	33652-05
33654-06	6	33652-06
33654-08	8	33652-08
33654-10	10	33652-10
33654-12	12	33652-12
33654-15	15	33652-15

HADEO
INSTRUMENTE GERMANY

Knorpelquetscher
Cartilage crusher
Macha cadera
Tritacartilagine



COTTLE
47461-00 7,5 cm, 3"

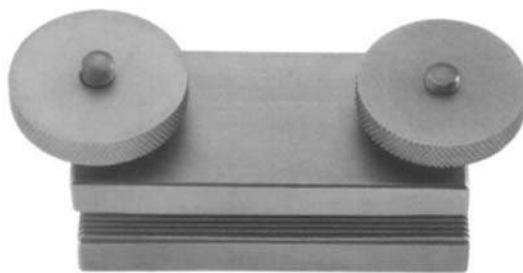

JOST
47462-00

HADEO
INSTRUMENTE GERMANY

Nasenraspeln
Nasal Rasps
Escofinas nasales
Raspa nasale



JOSEPH
47502-16 16 cm, 6 1/4"



MALTZ
47504-18 18 cm, 7"

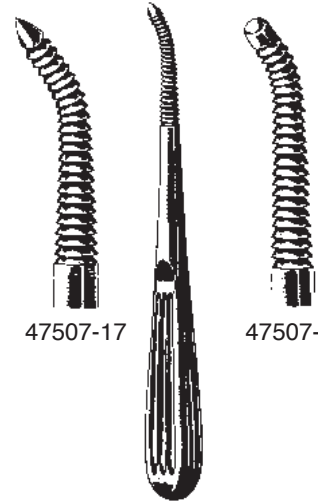

WIENER
18 cm, 7"



diamantiert
with diamond coating
con boca de diamante
diamantata

PEET
47523-01 19 cm 7 1/2" 47523-02



GLABELLA
47524-01 21 cm, 8 1/4"



47525-20
fein, fine, fino, fina
20 Zähne
20 teeth
20 dientes
20 denti

47526-20
grob, coarse, gruesa, grossa
11 Zähne
11 teeth
11 dientes
11 denti

PARKES
47525-20 21 cm, 8 1/4"

HADEO
INSTRUMENTE GERMANY

Nasenraspeln
Nasal Rasps
Escofinas nasales
Raspa nasale

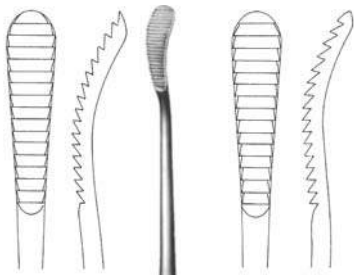

AUFRICHT
47511-21 21 cm, 8 1/4" 47513-21

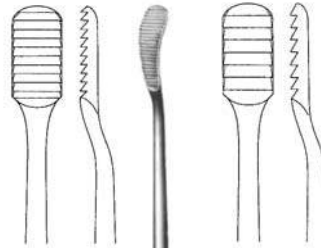

JOSEPH (LEWIS)
47514-16 18 cm, 7" 47516-16

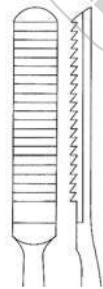

MALTZ (COTTLE)
47518-21 21 cm, 8 1/4"



47505-18 TC



47506-18 TC

MALTZ
17,5 cm, 6.9"



Nasenraspeln
Nasal Rasps
Escofinas nasales
Raspa nasale

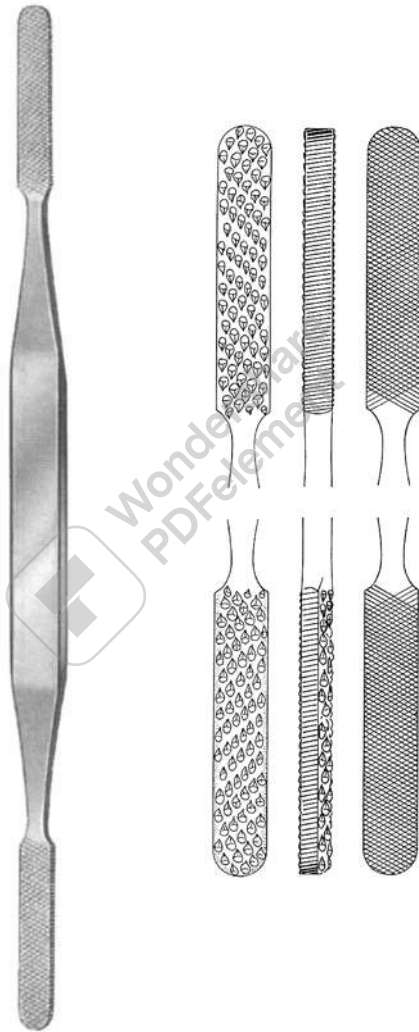

FOMON
47520-21
21 cm, 8¹/₄"

Nasenraspeln
Nasal Rasps
Escofinas nasales
Raspa nasale



FOMON

47522-01TC - 47522-09 TC
20 cm, 8"

Fig. 1/2 47522-01 TC Fig. 3/4 47522-04 TC Fig. 5/6 47522-05 TC Fig. 7/8 47522-07 TC Fig. 9/10 47522-09 TC

HADEO
INSTRUMENTE GERMANY

Nasenraspeln, Nasensägen
Nasal Rasps, Nasal Saws
Escofinas nasales, Sierras nasales
Raspa nasale, Seghe nasale

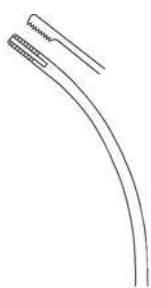

47530-01
Fig. 1



47530-02
Fig. 2



Drahtbürste zum Reinigen von Raspeln
Wirebrush for cleaning the rasps
Cepillo de alambre para limpiar las escofinas
Spazzolino di fili metallici per pulire le raspe

DINGMAN Set
47530-00 15 cm, 6"

47531-00 16 cm, 6 1/4"



47533-19
gerade
straight
recta
retta



47532-19
links
left
izquierda
sinistra



47534-19
rechts
right
derecha
destra

JOSEPH
19 cm, 7 1/2"

HADEO
INSTRUMENTE GERMANY

Nasensägen
Nasal Saws
Sierras nasales
Seghe nasale



JOSEPH
47535-01 17 cm, 6³/₄" 47535-02

HADEO
INSTRUMENTE GERMANY

Septumrichtzangen
Septum Straightening Forceps
Pinza para enderezar el tabique nasal
Pinza per la plastica nasale



ASCH
47571-23
23 cm, 9"



47572-23
gerade
straight
recta
retta

47573-23
links
left
izquierda
a sinistra

47575-23
rechts
right
derecha
a destra

WALSHAM
47572-23
23 cm, 9"

HADEO
INSTRUMENTE GERMANY

Zungendrücker, Mundsperrer
Tongue Depressors, Mouth Gags
Boja-lengua, Abre-Bocas
Abbassalingua, Apribocca



49115-01
Fig. 1
14 cm, 5 1/2"

49115-02
Fig. 2
15 cm, 6"

WIEDER



ANDREW
49117-11
11 cm, 4 3/8"

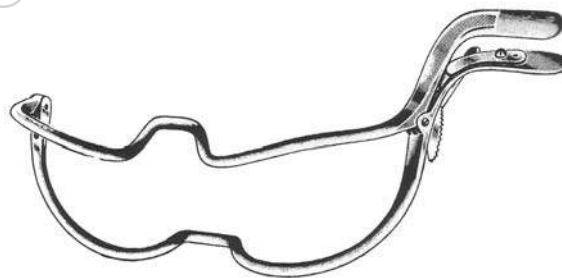

JENNINGS
49274-09 9 cm, 3 1/2"
49274-11 11 cm, 4 3/8"
49274-13 13 cm, 5 1/8"
49274-15 15 cm, 6"

HADEO
INSTRUMENTE GERMANY

Mundsperrer
Mouth Gags
Abre-Bocas
Apribocca

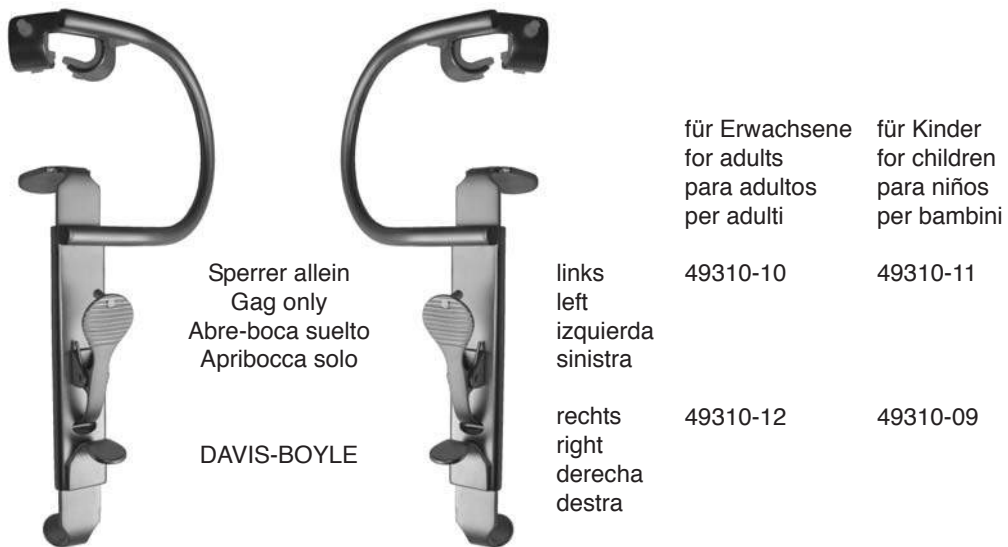

HADEO
INSTRUMENTE GERMANY

Mundsperrer
Mouth Gags
Abre-Bocas
Apribocca

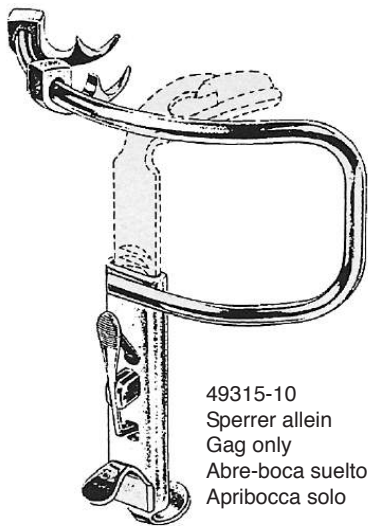

49315-10
Sperrer allein
Gag only
Abre-boca suelto
Apribocca solo

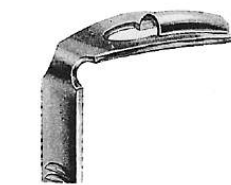

49315-01
Fig.1



49315-02
Fig.1



49315-03
Fig.1

KILNER-DOUGHTY
49315-00
compl.

49317- 00 DINGMANN, komplett
mit 3 auswechselbaren Zungendrucker,
2 seitliche Wangenhaken und 2 Zahnhaken

with 3 interchangeable tongue depressors,
2 rotating cheek holders,
2 movable tooth hooks an thread guide

con 3 baja lenguas intercambiables
2 valvas giratorias p. los labios
2 ganchos graduables

con 3 depressori intercambiabili,
2 valve laterali rotative,
2 uncini a denti mobile

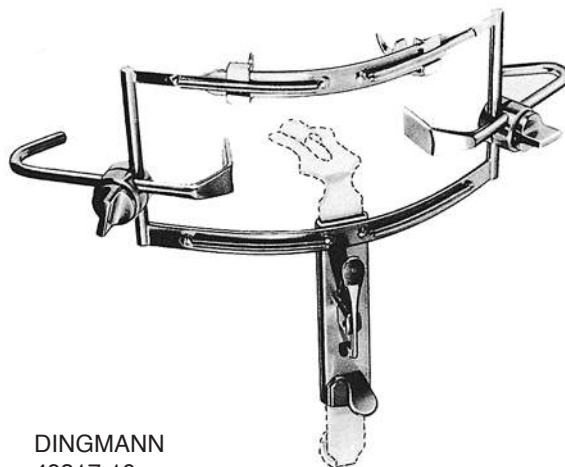

DINGMANN
49317-10
Sperrer allein, Gag only
Abre-boca suelto, Apribocca solo



1 24x62 mm
49317-01



2 28x65 mm
49317-02



3 31x75 mm
49317-03

HADEO
INSTRUMENTE GERMANY

Mundsperrer, Zungenspatel
Mouth Gags, Tongue depressor
Abre-Bocas, Baja-lengua
Apribocca, Abbassalingua

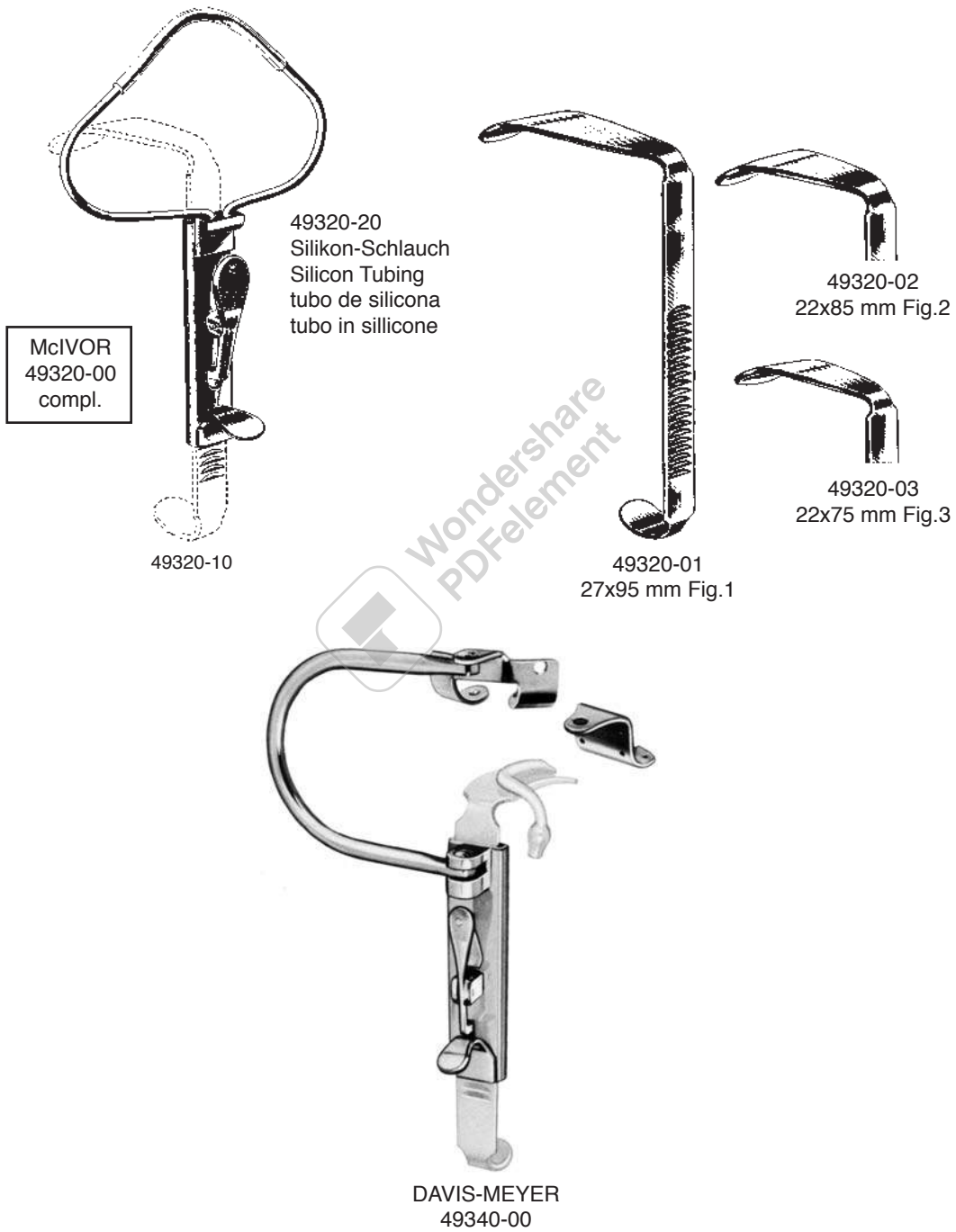

HADEO
INSTRUMENTE GERMANY

Zungenspatel
Tongue blades
Baja-lenguas
Abbassalingua



HADEO
INSTRUMENTE GERMANY

Wundhaken für Mund-Kiefer-Gesicht
Retractors, Raspatories for Mouth-, Jaw- and Face Surgery
Separadores para cirugía de boca -mandíbula- fiscal
Divaricatori, Periostotomi per bocca, mascella, viso



OBWEGESER
22 cm, 8³/₄"



49605-07 25x7 mm



49605-10 31x10 mm



49605-11 42x11 mm

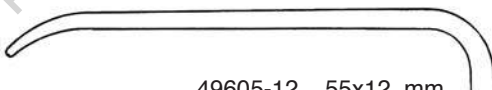

49605-12 55x12 mm

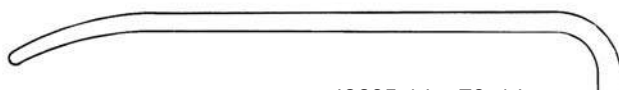

49605-14 70x14 mm



49605-16 80x16 mm

HADEO
INSTRUMENTE GERMANY

Wundhaken für Mund-Kiefer-Gesicht
Retractors, Raspatories for Mouth-, Jaw- and Face Surgery
Separadores para cirugía de boca -mandíbula- fiscal
Divaricatori, Periostotomi per bocca, mascella, viso



OBWEGESER
22 cm, 8³/₄"

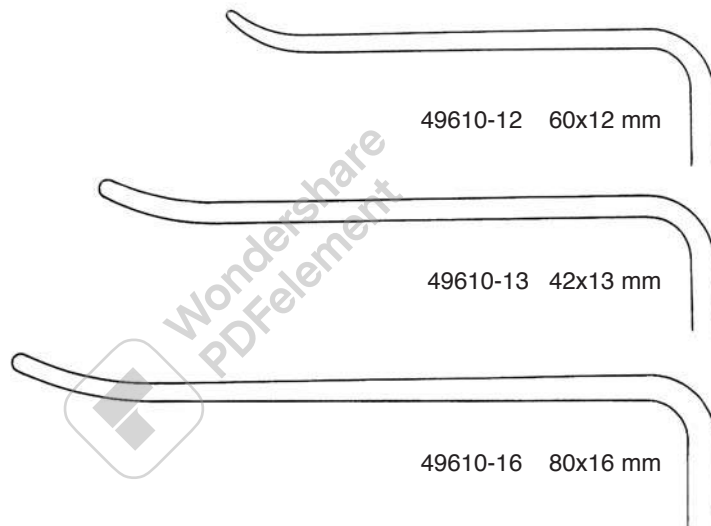

HADEO
INSTRUMENTE GERMANY

Wundhaken für Mund-Kiefer-Gesicht
Retractors, Raspatories for Mouth-, Jaw- and Face Surgery
Separadores para cirugía de boca- mandibula- fiscal
Divaricatori, per bocca, mascella, viso

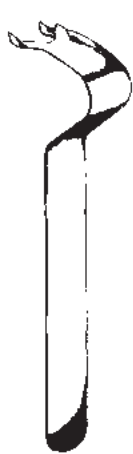
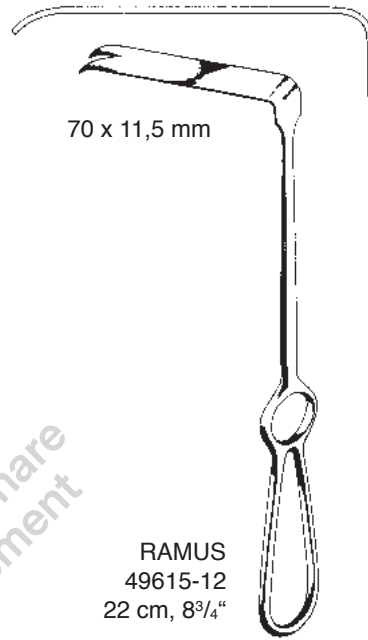
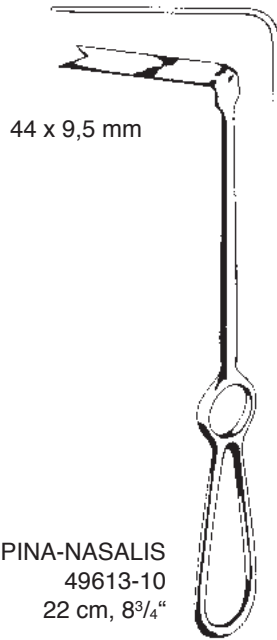

OBWEGESER
49620-15
15,5 cm, 6"

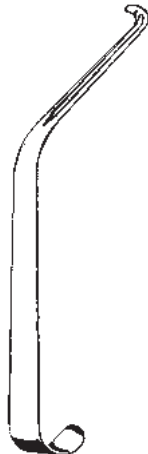

OBWEGESER
49623-16
16 cm, 6¹/₄"

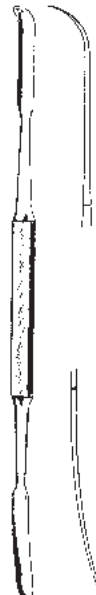

OBWEGESER
49627-01
21 cm, 8¹/₄"



OBWEGESER
49630-02
20,5 cm, 8"



Raspatorien, Elevatoren
Periosteal Elevators
Legras
Periostotomi



OBWEGESER
49635-18 17,5 cm, 7"



OBWEGESER
20 cm, 8"

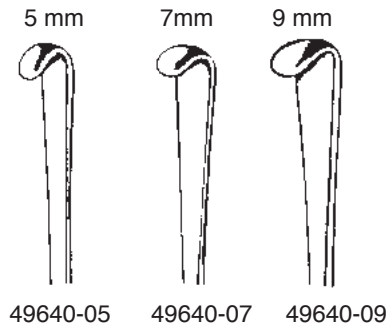

OBWEGESER
17,5 cm, 7"



49650-06



49650-07



49650-09



49650-11

HADEO
INSTRUMENTE GERMANY

Raspator, Wundhaken, Elevator
Raspatories, Retractor, Elevators
Legras, Separadores, Elevadores
Periostotomo, Divaricatore, Elevatore

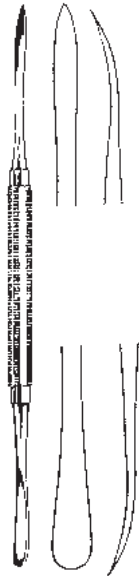

DINGMAN
49660-18 18 cm, 7"



19 cm, 7 1/2"

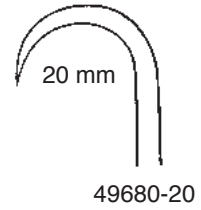
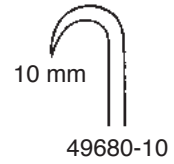

DINGMAN
49685-21 21 cm, 8 1/4"

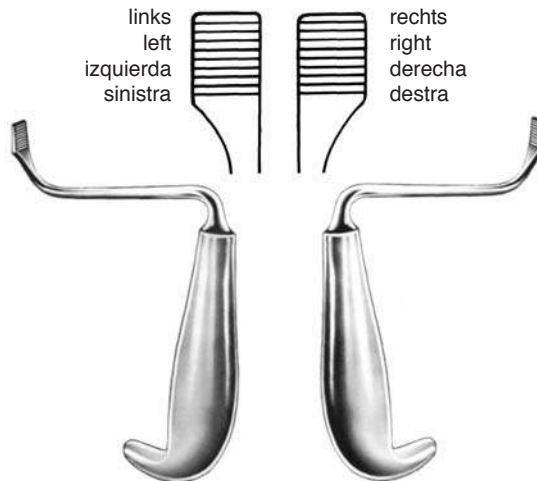

TESSIER
49691-15 15 cm, 6"

TESSIER
49692-15 15 cm, 6"

HADEO
INSTRUMENTE GERMANY

Osteotome
Osteotome
Osteótomos
Osteotomi



49666-10 10 mm
49666-15 15 mm
49666-20 20 mm

TESSIER
20,5 cm 8"



49667-10 10 mm
49667-15 15 mm

TESSIER
20,5 cm 8"



7 mm

49700-01
21,5 cm, 8 1/2"



10 mm

49700-02
21,5 cm, 8 1/2"

HADEO

INSTRUMENTE GERMANY

Endoskopische Instrumente
Endoscopic Instruments
Instrumentos para endoscopia
Strumenti endoscopici

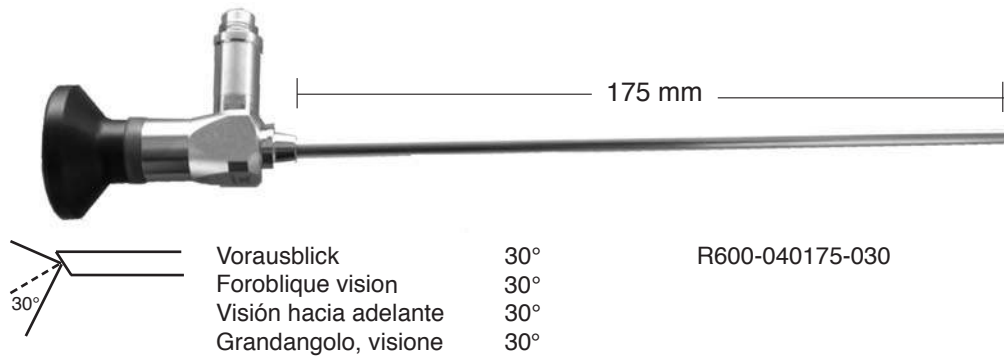

Endoskop für plastische Chirurgie 4 mm Ø, 30° Blickrichtung, 175 mm Nutzlänge, autoklavierbar, integrierte Faser für Ausleuchtung

Endo-Plastic-Scope 4 mm Ø, 30° direction of view, 175 mm working length, autoclavable, integrated fiberoptic bundle for illumination

Optica para endoplastia de 4 mm Ø, vision de 30°, largo útil de 175 mm, autoclavable, con fibra-optica para la iluminación

Ottica per endoplastica 4 mm Ø, visione 30°, lunghezza utile 175 mm, autoclavabile con fibre ottiche per illuminazione

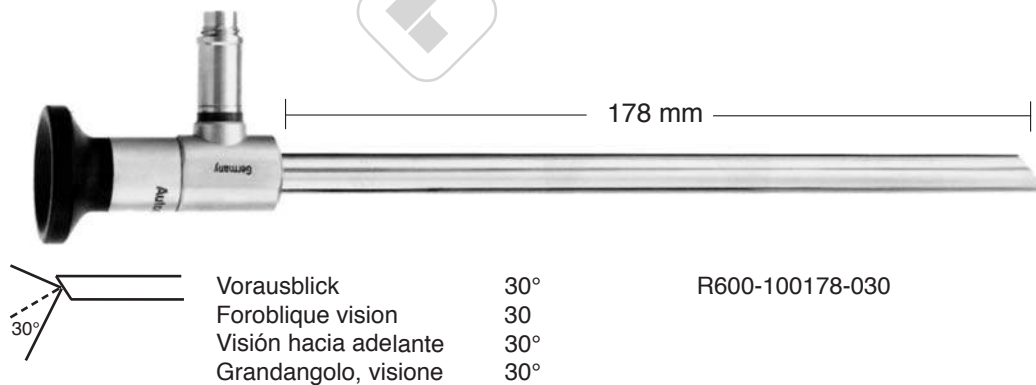

Endo-Plastik-Optik 10 mm Ø, 30° Blickrichtung, 178 mm Nutzlänge, autoklavierbar, integrierte Fiberoptik für Ausleuchtung

Endo-Plastic-Scope 10 mm Ø, 30° direction of view, 178 mm working length, autoclavable, integrated fiberoptic bundle for illumination

Optica para endoplastia de 10 mm Ø, vision de 30°, largo útil de 178 mm, autoclavable, con fibra-optica para la iluminación

Ottica per endoplastica 10 mm Ø, visione 30°, lunghezza utile 178 mm, autoclavabile con fibre ottiche per illuminazione

HADEO
INSTRUMENTE GERMANY

Endoskopische Instrumente
Endoscopic Instruments
Instrumentos para endoscopia
Strumenti endoscopici



Schaft für Plastische Chirurgie mit 1 Hahn, drehbar, passend für 4 mm Optik mit 175 mm Nutzlänge
Endo-Plastic Sheath with spatula, 1 stopcock rotatable, for 4 mm scope with 175 mm work. length
Camisa para cirugía plástica, una llave giratoria, para óptica de 4 mm, largo útil de 175 mm
Camicia per chirurgia plastica, con spatola, 1 rubinetto rotante, per ottica 4 mm,
lunghezza 175 mm

7x17 mm gefenstert / 7x17 mm fenestrated
7x17 mm fenestrada / 7x17 mm fenestrata

R610-040175-070

11x17 mm gefenstert / 11x17 mm fenestrated
11x17 mm fenestrada / 11x17 mm fenestrata

R610-040175-110

11x23 mm gefenstert / 11x23 mm fenestrated
11x23 mm fenestrada / 11x23 mm fenestrata

R610-040175-115

HADEO
INSTRUMENTE GERMANY

Endoskopische Instrumente
Endoscopic Instruments
Instrumentos para endoscopia
Strumenti endoscopici



R610-040175-001

Schaft für Plastische Chirurgie, schnabelförmig, breit/flach, 1 Hahn, drehbar,
passend für 4 mm Optik mit 175 mm Nutzlänge

Endo-Plastic Sheath with oblique beak wide/flat, 1 stopcock rotatable,
suitable f. 4 mm scope with 175 mm working length

Camisa para cirugía plástica en forma de pico, ancho y plano, con una llave giratoria,
para óptica de 4 mm, largo útil de 175 mm

Camicia per chirurgia plastica, a forma di becco, larga/piatta, 1 rubinetto rotante,
per ottica 4 mm, lunghezza utile 175 mm

HADEO
INSTRUMENTE GERMANY

Endoskopische Instrumente
Endoscopic Instruments
Instrumentos para endoscopia
Strumenti endoscopici



R610-040175-005

Schaft für Plastische Chirurgie, schnabelförmig, 1 Hahn, drehbar, passend für 4 mm Optik mit 175 mm Nutzlänge

Endo-Plastic Sheath with oblique beak, 1 stopcock rotatable, suitable f. 4 mm scope with 175 mm working length

Camisa para cirugía plástica en forma de pico, con una llave giratoria, para óptica de 4 mm, largo útil de 175 mm

Camicia per chirurgia plastica, a forma di becco, 1 rubinetto rotante, per ottica 4 mm, lunghezza utile 175 mm

HADEO

INSTRUMENTE GERMANY

Endoskopische Instrumente
Endoscopic Instruments
Instrumentos para endoscopia
Strumenti endoscopici



R631-030160-110

Schere gerade, drehbar für rechte und linke Anwendung, 3 mm Ø,
Griff mit HF-Anschluß, isoliert

Endoscopic Scissors, straight, insulated shaft, 3 mm Ø,
handle with HF connector, rotatable

Tijera recta, giratoria, para su aplicación hacia la derecha y la izquierda,
3 mm Ø, mango con contacto de alta frecuencia, aislada
Forbice, retta, 3 mm Ø, rotante, per uso a destra e a sinistra,
impugnatura con attacco per alta frequenza



R631-030160-112

Schere Metzenbaum, gebogen, drehbar für rechte und linke Anwendung,
3 mm Ø, Griff mit HF-Anschluß, isoliert

Endoscopic Metzenbaum Scissor, curved, insulated shaft, 3 mm Ø,
handle with HF connector, rotatable

Tijera curva, giratoria, para su aplicación hacia la derecha y la izquierda,
3 mm Ø, mango con contacto de alta frecuencia, aislada
Forbice Metzenbaum, curva, 3 mm Ø, rotante, per uso a destra e a
sinistra, impugnatura con attacco per alta frequenza



R631-030160-116

Hakenschere, drehbar für rechte und linke Anwendung, 3 mm Ø,
Griff mit HF-Anschluß, isoliert

Endoscopic Micro Hook Scissor, curved shaft for left or right hand,
3 mm Ø, handle with HF connector, rotatable

Tijera de pico, giratoria, para su aplicación hacia la derecha y la izquierda,
3 mm Ø, mango con contacto de alta frecuencia, aislada
Forbice ad uncino, curva, 3 mm Ø, rotante, per uso a destra e a sinistra,
impugnatura con attacco per alta frequenza

HADEO
 INSTRUMENTE GERMANY

 Endoskopische Instrumente
 Endoscopic Instruments
 Instrumentos para endoscopia
 Strumenti endoscopici

R631-030160-212

 Maryland Faszgrasper gebogen, drehbar, für rechte und linke Anwendung,
 3 mm Ø, Griff mit HF-Anschluß, isoliert

 Endoscopic Curved Grasper, rotating, insulated shaft for left and right,
 3 mm Ø, handle with HF connector

 Pinza de agarre raspar tipo Maryland, giratoria, para su aplicación hacia la
 derecha y la izquierda, 3 mm Ø, mango con contacto de alta frecuencia, aislada
 Pinza da presa Maryland, curva, rotante, per uso a destra e a sinistra,
 Ø 3 mm, impugnatura con attacco per alta frequenza

R631-030160-224

 Delphinazange, drehbar für rechte und linke Anwendung, 3 mm Ø,
 Griff mit HF-Anschluß, isoliert

 Endoscopic Needle Nose Grasper, rotatable for left and right use, 3 mm Ø,
 handle with HF connector

 Pinza de agarre en forma de delfino, giratoria, para su aplicación hacia la
 derecha y la izquierda, 3 mm Ø, mango con contacto de alta frecuencia, aislada
 Pinza da presa, rotante, per uso a destra e a sinistra, morso a delfino,
 Ø 3 mm, impugnatura con attacco per alta frequenza

R631-030160-246

 Faßgrasper, retrograd gezahnt, drehbar für rechte und linke Anwendung,
 3 mm Ø, Griff mit HF-Anschluß, isoliert

 Endoscopic Heavy Grasper, rotatable for left and right, insulated, 3 mm Ø,
 handle with HF connector

 Pinza de agarre, con dentadura en forma retrógrada, giratoria, para la
 aplicación hacia la derecha y la izquierda, 3 mm Ø, mango con contacto de
 alta frecuencia, aislada

 Pinza da presa, retrograda, rotante, per uso a destra e a sinistra, 3 mm Ø,
 impugnatura con attacco per alta frequenza

HADEO

INSTRUMENTE GERMANY

Endoskopische Instrumente
Endoscopic Instruments
Instrumentos para endoscopia
Strumenti endoscopici

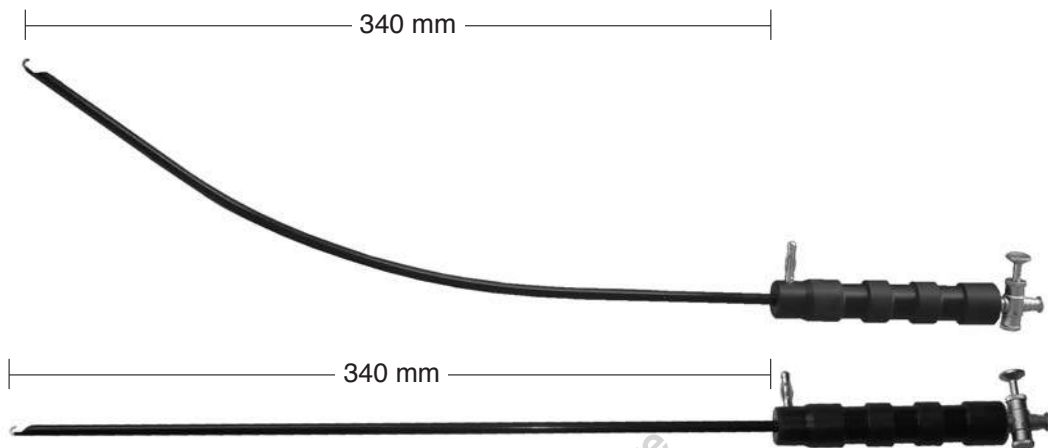

Monopolare Elektroden mit Saugkanal und Hahn, 5 mm Ø, 340 mm Nutzlänge
Monopolar electrodes with suction port and stopcock, 5 mm Ø, 340 mm working length
Electrodos monopolares con canal de succión y llave de 5 mm Ø, largo útil de 340 mm
Elettrodi monopolari con canale d'aspirazione e rubinetto, 5 mm Ø, lunghezza utile 340 mm



J-Haken Elektrode, gerade
J-Hook electrode straight
Electroda forma de gancho, recta
Elettrodo ad uncinetto, retto

R660-050340-002

J-Haken Elektrode, gebogen
J-Hook electrode curved
Electroda forma de gancho, curva
Elettrodo ad uncinetto, curvo

R661-050340-002



Spatel Elektrode, gerade
Spatula electrode straight
Electroda en forma de espátula, recta
Elettrodo a spatola, retto

R660-050340-004

Spatel Elektrode, gebogen
Spatula electrode curved
Electroda en forma de espátula, curva
Elettrodo a spatola, curvo

R661-050340-004

SET/100 Basic Plastic Surgery – Basis Set Plastische Chirurgie

1x	07103-00	scalpel handle no. 3
1x	07115-00	scalpel blade fig. 15
1x	09305-14	JOSEPH, scissors, cvd., 14,5 cm
1x	09310-12	KILNER, scissors, cvd., 12 cm
1x	09340-11	IRIS, scissors, str., 11 cm
1x	09341-11	IRIS, scissors, cvd., 11 cm
2x	11176-12	ADSON micro, dressing forceps, 12 cm
2x	11186-12	ADSON micro, tissue forceps, 1x2 t., 12 cm
4x	13220-12	HALSTED-MOSQUITO, forceps, str., 12,5 cm
6x	13221-12	HALSTED-MOSQUITO, forceps, cvd., 12,5 cm
2x	13320-14	ROCHESTER-OCHSNER, forceps, 1x2 t., str., 14 cm
4x	15111-09	BACKHAUS, towel forceps, 9 cm
2x	17170-18	FOERSTER, swab forceps, str., 18 cm
1x	19216-01	JOSEPH, hooklet, sharp, 1 prong, 16 cm
1x	19216-02	JOSEPH, hooklet, sharp, 2 prongs, 16 cm
1x	19650-10	WEITLANER, retractor, sharp, 11,5 cm
1x	21110-14	grooved director, 14,5 cm
1x	25137-11	BABY WEBSTER, needle holder TC, 11 cm
1x	25164-15	CRILE-WOOD, needle holder TC, 15 cm
1x	47560-18	GILLIES, hooklet, delicate, fig. 1, 18cm
2x	65110-15	ALLIS, tissue forceps, 4x5 t., 15 cm
1x	89127-08	bowl round, stainless steel, 80x40 mm, 0,14 l

SET/101 Abdominoplasty Set – Abdominoplastik Set

1x	07104-00	scalpel handle no. 4
1x	07120-00	scalpel blade fig. 20
1x	09165-14	MAYO, scissors TC, cvd., 14,5 cm
1x	10039-23	KAYE, face lift Supercut scissors, cvd., 23 cm
1x	10011-19	GORNEY, face lift scissors, cvd., 18,5 cm
1x	11112-18	POTTS-SMITH, dressing forceps, 18 cm
1x	11126-18	POTTS-SMITH, tissue forceps, 1x2 t., 18 cm
1x	11176-12	ADSON micro, dressing forceps, 12 cm
1x	11186-12	ADSON mirco, tissue forceps, 1x2 t., 12 cm
1x	11188-12	ADSON-BROWN, tissue forceps, 7x7 t., 12 cm
6x	15111-13	BACKHAUS, towel forceps, 13 cm
1x	19102-12	FARABEUF, retractor, double pair, 12 cm
2x	19216-07	JOSEPH, hooklet, sharp, 2 prongs, 16 cm
1x	19364-60	ISRAEL, retractor, blunt, 50x60 mm, 25 cm
1x	25144-13	HALSEY, needle holder TC, 13 cm
1x	25184-16	MAYO-HEGAR, needle holder TC, 16 cm
1x	25184-20	MAYO-HEGAR, needle holder TC, 20 cm

SET/102 Skin Graft Set – Hautverpflanzung Set

1x	03350-15	tape measure metal, 1,5 m
1x	07103-00	scalpel handle no. 3
1x	07115-00	scalpel blade fig. 15
1x	07490-00	SCHINK, dermatome, 30 cm
1x	09283-15	METZENBAUM-FINO, scissors, cvd, 15 cm
1x	09283-18	METZENBAUM-FINO, scissors, cvd., 18 cm
1x	11260-15	SEMKEN, dressing forceps, 15,5 cm
1x	11270-15	SEMKEN, tissue forceps, 1x2 t., 15,5 cm
3x	13221-12	HALSTED-MOSQUITO, forceps, cvd., 12,5 cm
4x	15111-13	BACKHAUS, towel forceps, 13 cm
1x	19212-01	GUTHRIE, double hooklet, small, 12 cm
1x	19240-10	SENN-GREEN, retractor, 10x6mm, 15cm
1x	25214-18	DeBAKEY, needle holder TC, 18 cm
1x	25164-15	CRILE-WOOD, needle holder TC, 15 cm
1x	47560-18	GILLIES, hooklet, delicate, fig. 1, 18 cm
2x	65110-15	ALLIS, tissue forceps, 4x5 t., 15 cm

SET/103 Nose Correction – Nasenkorrektur Set

1x	07107-00	scalpel handle no. 7
1x	07115-00	scalpel blade fig. 15
1x	09304-14	JOSEPH, scissors, str., 14 cm
1x	09310-12	KILNER, scissors, cvd., 12 cm
1x	09321-15	REYNOLDS, scissors, cvd., 15 cm
1x	09401-18	HEYMANN, scissors, 18 cm
1x	11176-12	ADSON micro, dressing forceps, 12 cm
1x	11186-12	ADSON micro, tissue forceps, 1x2 t., 12 cm
1x	11188-12	ADSON-BROWN, tissue forceps, 7x7 t., 12 cm
1x	13220-12	HALSTED-MOSQUITO, forceps, str., 12,5 cm
1x	13223-12	HALSTED-MOSQUITO, forceps, cvd., 12,5 cm
1x	13312-14	PEAN, forceps, str., 14 cm
4x	15111-13	BACKHAUS, towel forceps, 13 cm
1x	17111-20	GROSS-MAIER, dressing forceps, cvd., 20 cm
1x	19212-01	GUTHRIE, double hooklet, 12 cm
1x	19216-02	JOSEPH, hooklet, sharp, 2 prongs, 16 cm
1x	19218-01	BARSKY, hook, 15 cm
1x	19230-12	DESMARRES, retractor, 16 cm
1x	25137-11	BABY WEBSTER, needle holder TC, 11 cm
1x	25164-15	CRILE-WOOD, needle holder TC, 15 cm
1x	33100-01	FRIEDMAN micro, bone rongeur, str., 14 cm
1x	33694-01	mallet with interchangeable plastic, 18,5 cm
1x	33711-16	WILLIGER, raspatory, str., 16cm
1x	33711-20	LANGENBECK, elevator, 20 cm
1x	45206-14	LUCAE, ear forceps, 14 cm
1x	47120-35	KILLIAN, nasal speculum, 35 mm, 13 cm
1x	47120-50	KILLIAN, nasal speculum, 50 mm, 13 cm
1x	47224-01	WEIL-BLAKESLEY, forceps, fig. 1, 45°, 3 mm
1x	47256-20	CAPLAN, nasal cutting forceps, 20 cm
1x	47347-20	GUILLEN, suction raspatory, 19 cm
1x	47374-16	FREER, mucosa knife, 16,5 cm
1x	47423-22	COTTLE, septum elevator, 22 cm
1x	47454-04	COTTLE, rhinoplastic osteotome, 18 cm
1x	47454-07	COTTLE, rhinoplastic osteotome, 18 cm
1x	47470-04	FOMON, osteotome, 17 cm
1x	47522-05	FOMON, nasal raspel TC, fig. 5/6, 20 cm
1x	47551-16	AUFRICHT, nasal retractor, 16 cm
1x	47555-08	KILNER, nasal retractor, 8 cm
1x	47565-10	COTTLE, columella forceps, 10 cm
1x	47571-23	ASCH, septum forceps, str., 23 cm
1x	89127-08	bowl round, stainless steel, 80x40 mm, 0,14 l

SET/104 Face Lift Set

1x	03370-16	PITANGUY, facelift marker, 16 cm
1x	07107-00	scalpel handle no. 7
1x	07115-00	scalpel blade fig. 15
1x	09345-11	IRIS, scissors TC, cvd., 11 cm
1x	10015-19	GORNEY, face lift Supercut scissors, cvd., 18,5 cm
1x	10045-14	PECK-JOSEPH, dissecting scissors, cvd., 14,5 cm
1x	11176-12	ADSON micro, dressing forceps, 12 cm
1x	11186-12	ADSON micro, tissue forceps, 1x2 t., 12 cm
1x	11188-12	ADSON-BROWN, tissue forceps, 7x7 t., 12 cm
1x	11231-20	BROPHY, tissue forceps, 1x2 t., 20 cm
1x	13364-14	MARTEL, scalp flap forceps, 14 cm
1x	19102-12	FARABEUF, retractor double pair, 12 cm
1x	19216-02	JOSEPH, hooklet, sharp, 2 prongs, 16 cm
1x	19314-16	KOCHER-LANGENBECK, retractor, 21 cm
1x	19995-38	FREEMAN, retractor, sharp, 4 prongs, 18 cm
1x	25144-13	HALSEY, needle holder TC, 13 cm
1x	25164-15	CRILE-WOOD, needle holder TC, 15 cm
1x	47560-18	GILLIES, hooklet, delicate, fig. 1, 18 cm

**SET/105 Eyelid Plastic (Blepharoplasty) –
Set zur Lidstraffung (Blepharoplastik)**

1x	07103-00	scalpel handle no. 3
1x	07115-00	scalpel blade fig. 15
1x	09341-11	IRIS, scissors, cvd., 11 cm
1x	09362-11	STEVENS, scissors, str. 11 cm
1x	10313-14	GOMEL, scissors, cvd., 14 cm
1x	11186-12	ADSON micro, tissue forceps, 1x2 t., 12 cm
1x	13220-12	HALSTED-MOSQUITO, forceps, str., 12,5 cm
1x	13221-12	HALSTED-MOSQUITO, forceps, cvd., 12,5 cm
4x	15111-09	BACKHAUS, towel forceps, 9 cm
1x	19216-01	JOSEPH, hooklet, sharp, 1 prong, 16 cm
1x	19216-02	JOSEPH, hooklet, sharp, 2 prongs, 16 cm
1x	19230-12	DESMARRES retractor, 16 cm
1x	25670-14	CASTROVIEJO, needle holder, str., 14 cm
1x	44150-01	CASTROVIEJO, suturing forceps, 0,1 mm, 10 cm
1x	47560-18	GILLIES, hooklet, delicate, fig. 1, 18 cm

SET/106 Mammoplasty – Mammoplastik Set

1x	03340-20	ruler metal, 20 cm
1x	03500-38	FREEMAN, marker, 38 mm
1x	03500-42	FREEMAN, marker, 42 mm
1x	03500-44	FREEMAN, marker, 44 mm
1x	07107-00	scalpel handle no. 7
1x	07115-00	scalpel blade fig. 15
1x	09281-18	METZENBAUM, scissors, 18 cm
1x	09310-15	KILNER, scissors, 15 cm
1x	09583-15	neurosurgery scissors, cvd., 15 cm
1x	11102-14	dressing forceps, 14,5 cm
1x	11186-12	ADSON micro, tissue forceps, 1x2 t., 12 cm
2x	13223-12	HALSTED-MOSQUITO, micro, forceps, cvd., 12,5 cm
2x	13231-12	HALSTED-MOSQUITO, forceps, cvd., 12,5 cm
1x	13475-18	MIXTER BABY, forceps, 18 cm
6x	15111-13	BACKHAUS, towel forceps, 13 cm
1x	17110-25	GROSS-MAIER, dressing forceps, 25 cm
1x	19102-12	FARABEUF, retractor double par, 12 cm
1x	19314-12	KOCHER-LANGENBECK, retractor, 21 cm
1x	19999-00	AGRIS-DINGMAN, breast dissector, set of 2, 36 cm
1x	19999-02	TEBBETTS, breast dissector, 33 cm
1x	25164-15	CRILE-WOOD, needle holder TC, 15 cm
1x	25180-16	MAYO-HEGAR, needle holder, 16 cm
1x	47154-20	JANSEN, nasal forceps, 20 cm
1x	89127-08	bowl round, stainless steel, 80x40mm, 0,14 l

HADEO
 INSTRUMENTE GERMANY

 Nummernverzeichnis
 Numerical Index
 Índice numérico
 Indice numerico

03312-01.....2	07490-01.....5	09282-20.....17	09350-09.....23	09963-17.....13
03314-01.....2	07490-02.....5	09282-23.....17	09350-10.....22	09964-15.....14
03340-10.....2	07495-31.....6	09283-15.....17	09351-09.....23	09964-17.....14
03340-15.....2	07496-31.....6	09283-18.....17	09352-09.....23	09965-15.....14
03340-20.....2	07498-00.....6	09283-20.....17	09352-10.....22	09965-17.....14
03340-30.....2	07499-00.....6	09283-23.....17	09353-09.....23	09966-11.....16
03340-50.....2	07499-01.....6	09284-12.....16	09354-10.....23	09967-11.....16
03370-16.....3	09160-14.....13	09284-15.....16	09355-10.....23	09970-14.....16
03380-30.....3	09160-17.....13	09284-18.....16	09356-10.....23	09970-18.....16
03390-30.....3	09161-14.....13	09284-20.....16	09357-10.....23	09970-20.....16
03400-38.....4	09161-17.....13	09284-23.....16	09358-11.....22	09970-23.....16
03400-42.....4	09164-14.....13	09285-12.....16	09360-11.....24	09971-14.....16
03400-45.....4	09164-17.....13	09285-15.....16	09361-11.....24	09971-18.....16
03500-38.....4	09165-14.....13	09285-18.....16	09362-11.....24	09971-20.....16
03500-42.....4	09165-17.....13	09285-20.....16	09363-11.....24	09971-23.....16
03500-44.....4	09170-15.....14	09285-23.....16	09370-11.....24	09980-11.....20
07103-00.....7	09170-17.....14	09286-15.....17	09371-11.....24	09981-11.....20
07103-01.....7	09171-15.....14	09286-18.....17	09374-11.....24	09982-12.....25
07103-02.....7	09171-17.....14	09286-20.....17	09375-11.....24	09983-12.....25
07103-03.....7	09174-15.....14	09286-23.....17	09401-18.....27	09984-11.....24
07104-00.....8	09174-17.....14	09287-15.....17	09403-15.....27	09985-11.....24
07104-02.....8	09175-15.....14	09287-18.....17	09405-16.....27	09993-15.....19
07105-02.....8	09175-17.....14	09287-20.....17	09405-16TC...27	09995-12.....19
07106-01.....8	09190-16.....15	09287-23.....17	09406-10.....27	10010-19.....30
07107-00.....9	09191-16.....15	09302-14.....18	09407-10.....27	10011-19.....30
07107-01.....9	09194-16.....15	09303-14.....18	09540-16.....19	10012-19.....30
07108-00.....9	09195-16.....15	09304-14.....18	09541-16.....19	10013-19.....30
07109-10.....10	09202-10.....15	09305-14.....18	09542-16.....19	10014-19.....30
07109-13.....10	09203-10.....15	09310-12.....19	09543-16.....19	10015-19.....30
07109-15.....10	09206-10.....15	09310-15.....19	09544-16.....19	10028-14.....31
07110-00.....11	09207-10.....15	09314-12.....19	09545-16.....19	10029-14.....31
07111-00.....11	09270-15.....17	09321-15.....19	09614-19.....29	10030-18.....31
07112-00.....11	09270-18.....17	09321-18.....19	09617-13.....27	10031-18.....31
07113-00.....11	09271-15.....17	09340-09.....20	09802-09.....28	10032-23.....31
07115-00.....11	09271-18.....17	09340-10.....20	09802-11.....28	10033-23.....31
07116-00.....11	09274-15.....17	09340-11.....20	09804-14.....28	10034-14.....31
07118-00.....11	09274-18.....17	09341-09.....20	09805-09.....28	10035-14.....31
07119-00.....11	09275-15.....17	09341-10.....20	09820-13.....29	10036-18.....31
07120-00.....11	09275-18.....17	09341-11.....20	09821-13.....29	10037-18.....31
07121-00.....11	09280-12.....16	09342-08.....20	09821-13SC...29	10038-23.....31
07122-00.....11	09280-15.....16	09343-08.....20	09823-12.....25	10039-23.....31
07123-00.....11	09280-18.....16	09344-11.....20	09824-12.....25	10044-14.....31
07124-00.....11	09280-20.....16	09345-11.....20	09825-12.....25	10045-14.....31
07125-00.....11	09280-23.....16	09346-11.....20	09826-12.....25	10048-14.....31
07130-00.....11	09281-12.....16	09348-01.....21	09828-12.....25	10049-14.....31
07161-00.....10	09281-15.....16	09348-02.....21	09829-12.....25	10050-14.....31
07162-00.....10	09281-18.....16	09348-03.....21	09854-11.....26	10050-18.....31
07165-00.....10	09281-20.....16	09348-04.....21	09855-11.....26	10051-14.....31
07167-00.....10	09281-23.....16	09348-05.....21	09962-14.....13	10051-18.....31
07296-00.....6	09282-15.....17	09348-06.....21	09962-17.....13	10061-19.....30
07490-00.....5	09282-18.....17	09349-12.....22	09963-14.....13	10061-19SC...30

Nummernverzeichnis
Numerical Index
Indice numérico
Indice numerico

HADEO
INSTRUMENTE GERMANY

10061-19TC...30	10228-18T.....35	11120-1437	11186-1239	11311-1744
10061-23.....30	10228-21.....35	11120-1637	11186-1539	11312-1744
10061-23SC...30	10228-23.....35	11120-1837	11187-1239	11312-1844
10061-23TC...30	10229-1135	11120-2037	11187-1841	11313-1744
10201-1132	10229-14.....35	11122-1237	11187-2041	11314-0144
10201-11SC...32	10229-18.....35	11122-1337	11187-2541	11314-0244
10202-1133	10229-18T.....35	11122-1437	11187-3041	11315-0144
10202-14.....33	10229-21.....35	11122-1537	11188-1240	11315-0244
10202-14T.....33	10229-23.....35	11122-1837	11188-12F.....40	11316-1445
10202-18.....33	10230-1135	11122-2137	11188-1540	11316-1645
10202-18T.....33	10230-14.....35	11124-1537	11189-1240	11316-2045
10202-2133	10230-18.....35	11126-1836	11189-1541	11317-0045
10202-21T.....33	10230-18T.....35	11126-2136	11189-2041	11317-1245
10202-23.....33	10230-21.....35	11126-2536	11189-2541	11317-2345
10203-1133	10230-23.....35	11130-11.....37	11190-1041	11318-1845
10203-14.....33	11102-1036	11130-1337	11191-1240	11318-2045
10203-14T.....33	11102-11.....36	11130-1437	11220-1741	11318-2545
10203-18.....33	11102-1336	11130-1637	11221-1741	11319-1245
10203-18T.....33	11102-1436	11130-1837	11222-1741	11319-1445
10203-2133	11102-1636	11130-2037	11223-1741	11320-1845
10203-21T.....33	11102-1836	11132-1637	11224-1741	11320-2345
10203-2333	11102-2036	11132-1837	11225-1741	11401-0146
10206-1132	11103-1436	11132-2037	11232-1541	11403-0346
10206-11SC...32	11104-1236	11140-11.....37	11246-1842	11403-0446
10207-1132	11104-1336	11140-1337	11248-1842	11404-0446
10207-11SC...32	11104-1436	11140-1437	11250-1442	11405-0546
10220-0034	11104-1536	11140-1637	11252-2042	11407-0746
10220-00T.....34	11104-1836	11140-1837	11256-1542	12090-15D47
10220-25.....34	11104-2136	11140-2037	11256-2042	12090-18D47
10220-25T.....34	11106-1336	11150-1337	11256-2542	12090-21D47
10220-45.....34	11106-1536	11150-1437	11257-1542	12090-23D47
10220-45T.....34	11110-1136	11150-1637	11258-1542	12091-15D47
10220-60.....34	11110-13.....36	11160-1337	11259-1542	12091-18D47
10220-60T.....34	11110-14.....36	11160-1437	11260-1243	12091-21D47
10220-90.....34	11110-16.....36	11160-1637	11260-1543	12091-23D47
10220-90T.....34	11110-18.....36	11170-1238	11261-1543	12102-1247
10226-1135	11110-20.....36	11170-12F.....38	11270-1243	12102-12D47
10226-14.....35	11110-25.....36	11170-1538	11270-1543	12102-2147
10226-18.....35	11112-18.....36	11174-1238	11271-1543	12102-21D47
10226-18T.....35	11112-21.....36	11174-1538	11271-1843	12102-2347
10226-2135	11112-25.....36	11176-1238	11272-1543	12102-23D47
10226-23.....35	11114-14.....36	11176-1538	11273-1543	12103-1247
10227-1135	11114-16.....36	11177-1238	11274-0643	12103-12D47
10227-14.....35	11114-20.....36	11178-1238	11274-0843	12103-1547
10227-18.....35	11114-25.....36	11179-1238	11274-1043	12103-15D47
10227-18T.....35	11116-18.....36	11180-1239	11302-1743	12104-1547
10227-2135	11116-21.....36	11180-12F.....39	11302-2343	12104-15D47
10227-23.....35	11116-25.....36	11180-1539	11303-1743	12108-1847
10228-1135	11120-1037	11181-1239	11304-1743	12108-18D47
10228-14.....35	11120-11.....37	11181-1539	11305-1744	12109-1847
10228-18.....35	11120-1337	11182-1239	11310-1744	12109-18D47

12109-21.....47	12308-24.....51	13251-18.....62	19170-50.....66	19230-12.....73
12109-21D.....47	12308-30.....51	13254-14.....62	19170-65.....66	19230-14.....73
12109-23.....47	12309-16.....51	13255-14.....62	19170-76.....66	19230-16.....73
12109-23D.....47	12309-20.....51	13256-14.....61	19180-19.....67	19230-18.....73
12112-15D.....48	12309-24.....51	13257-14.....61	19181-22.....67	19234-00.....73
12112-15T.....48	12309-30.....51	13258-16.....61	19181-25.....67	19237-16.....73
12112-18D.....48	12310-16.....51	13259-16.....61	19183-25.....67	19270-02.....73
12112-18T.....48	12310-20.....51	13260-14.....62	19185-25.....67	19270-03.....73
12112-21D.....48	12310-24.....51	13261-14.....62	19187-25.....67	19270-04.....73
12112-21T.....48	12310-30.....51	13262-16.....62	19188-12.....68	19270-06.....73
12112-23D.....48	13210-10.....59	13263-16.....62	19188-12CL.....68	19271-02.....73
12112-23T.....48	13211-10.....59	13264-16.....62	19210-12.....69	19271-03.....73
12114-15D.....48	13212-10.....59	13265-16.....62	19211-12.....69	19271-04.....73
12114-15T.....48	13213-10.....59	13270-14.....61	19212-01.....69	19271-06.....73
12114-18D.....48	13214-10.....59	13271-14.....61	19212-02.....69	19302-01.....74
12114-18T.....48	13215-10.....59	13310-13.....63	19213-12.....69	19302-02.....74
12114-21D.....48	13220-12.....60	13310-14.....63	19214-13.....70	19302-03.....74
12114-21T.....48	13220-14.....60	13310-16.....63	19214-18.....70	19302-04.....74
12114-23D.....48	13220-18.....60	13311-13.....63	19215-01.....70	19302-05.....74
12114-23T.....48	13220-21.....60	13311-14.....63	19215-02.....70	19302-06.....74
12115-15.....49	13221-12.....60	13311-16.....63	19215-03.....70	19307-01.....74
12115-15T.....49	13221-14.....60	13320-13.....63	19215-13.....70	19307-02.....74
12115-18.....49	13221-18.....60	13320-14.....63	19215-18.....70	19610-07.....75
12115-18T.....49	13221-21.....60	13320-16.....63	19216-01.....70	19611-07.....75
12115-21.....49	13222-12.....60	13321-13.....63	19216-02.....70	19620-07.....75
12115-21T.....49	13223-12.....60	13321-14.....63	19216-05.....70	19620-10.....75
12115-23.....49	13224-12.....60	13321-16.....63	19216-07.....70	19621-07.....75
12115-23T.....49	13225-12.....60	13380-15.....63	19216-10.....70	19621-10.....75
12116-15.....49	13226-12.....60	13381-15.....63	19217-03.....70	19630-10.....75
12116-18.....49	13227-12.....60	13382-15.....63	19217-05.....70	19631-10.....75
12116-21.....49	13230-12.....60	13383-15.....63	19217-07.....70	19634-10.....75
12116-23.....49	13230-14.....60	13410-18.....64	19218-01.....71	19635-10.....75
12117-18.....50	13230-18.....60	13411-18.....64	19218-02.....71	19650-10.....76
12117-21.....50	13230-21.....60	19102-12.....65	19218-11.....71	19651-10.....76
12117-23.....50	13231-12.....60	19102-15.....65	19220-01.....72	19670-14.....76
12118-18.....50	13231-14.....60	19124-15.....65	19220-02.....72	19671-14.....76
12118-21.....50	13231-18.....60	19125-14.....65	19220-03.....72	19741-01.....77
12118-23.....50	13231-21.....60	19127-11.....65	19220-04.....72	19741-02.....77
12302-16.....51	13232-12.....60	19168-06.....66	19221-01.....72	19741-03.....77
12302-20.....51	13233-12.....60	19168-08.....66	19221-02.....72	19741-04.....77
12302-24.....51	13240-14.....61	19168-10.....66	19221-03.....72	19741-05.....77
12304-16.....51	13240-18.....61	19168-12.....66	19221-04.....72	19741-06.....77
12304-20.....51	13241-14.....61	19168-17.....66	19226-02.....72	19741-07.....77
12304-24.....51	13241-18.....61	19168-20.....66	19226-03.....72	19741-08.....77
12304-30.....51	13242-16.....61	19168-25.....66	19226-04.....72	19741-09.....77
12306-16.....51	13243-16.....61	19169-25.....66	19227-02.....72	19741-10.....77
12306-20.....51	13244-14.....61	19170-20.....66	19227-03.....72	19741-11.....77
12306-24.....51	13245-14.....61	19170-25.....66	19227-04.....72	19741-12.....77
12306-30.....51	13250-14.....62	19170-32.....66	19229-02.....72	19741-13.....77
12308-16.....51	13250-18.....62	19170-40.....66	19229-03.....72	19960-01.....78
12308-20.....51	13251-14.....62	19170-45.....66	19230-10.....73	19960-02.....78

Nummernverzeichnis
Numerical Index
Indice numérico
Indice numerico

HADEO
INSTRUMENTE GERMANY

19960-03.....78	25180-14.....92	25671-18.....96	33100-02.....98	34556-18.....97
19960-04.....78	25180-16.....92	25672-14.....96	33101-12.....98	41054-20.....85
19960-05.....78	25180-18.....92	25672-14D.....96	33101-14.....98	41056-18.....85
19960-06.....78	25180-20.....92	25672-14T.....96	33201-18.....98	41058-18.....85
19970-01.....79	25184-12.....92	25672-18.....96	33211-15.....98	41068-20.....85
19980-01.....78	25184-14.....92	25672-18D.....96	33213-15.....98	41069-20.....85
19980-02.....78	25184-16.....92	25672-18T.....96	33280-15.....99	41290-21.....107
19980-03.....78	25184-18.....92	25672-21.....96	33281-15.....99	41295-06.....108
19980-04.....78	25184-20.....92	25672-21D.....96	33282-19.....99	41295-07.....108
19980-05.....78	25214-16.....92	25672-21T.....96	33283-17.....99	41295-08.....108
19980-06.....78	25214-18.....92	25672-23.....96	33652-02.....132	41295-09.....108
19980-18.....79	25214-20.....92	25672-23D.....96	33652-03.....132	41295-10.....108
19990-18.....79	25214-23.....92	25673-14.....96	33652-04.....132	41295-11.....108
19991-18.....79	25224-13.....93	25673-14D.....96	33652-05.....132	41295-12.....108
19992-31.....80	25224-15.....93	25673-14T.....96	33652-06.....132	41297-06.....108
19995-22.....79	25224-18.....93	25673-18.....96	33652-08.....132	41297-07.....108
19995-38.....79	25224-20.....93	25673-18D.....96	33652-10.....132	41297-08.....108
19996-04.....81	25225-13.....93	25673-18T.....96	33652-12.....132	41297-09.....108
19997-09.....81	25225-15.....93	25673-21T.....96	33652-15.....132	41297-10.....108
19998-03.....79	25225-18.....93	25674-14.....96	33654-02.....132	41297-11.....108
19998-05.....79	25225-20.....93	25674-18.....96	33654-03.....132	41297-12.....108
19999-00.....82	25230-18.....93	25674-21.....96	33654-04.....132	41299-03.....107
19999-01.....83	25230-20.....93	25675-14.....96	33654-05.....132	41299-05.....107
19999-02.....83	25405-12.....93	25675-18.....96	33654-06.....132	41299-07.....107
19999-03.....83	25406-12.....93	25676-14.....96	33654-08.....132	43150-11.....58
19999-04.....83	25407-12.....93	25677-14.....96	33654-10.....132	43370-12.....86
19999-30.....84	25408-12.....93	25691-18.....96	33654-12.....132	43372-13.....86
19999-30CL.....84	25410-14.....93	25700-18.....95	33654-15.....132	43373-13.....86
19999-50.....84	25410-17.....93	25701-18.....95	33686-25.....100	43376-13.....86
19999-50CL.....84	25414-14.....93	25720-12.....95	33693-32.....100	43377-13.....86
25110-12.....91	25414-17.....93	25720-12D.....95	33694-01.....100	43378-13.....86
25114-12.....91	25414-18.....93	25720-13.....95	33694-02.....100	43583-07.....4
25128-13.....91	25434-11.....94	25720-13D.....95	33694-03.....100	43583-18.....4
25129-13.....91	25434-13.....94	25720-14.....95	33696-75.....100	43810-10.....52
25130-13.....91	25434-16.....94	25720-14D.....95	33698-98.....100	43811-10.....52
25134-13.....91	25660-12.....95	25730-18.....95	33700-05.....100	43813-10.....52
25136-11.....91	25660-13.....95	25730-18D.....95	33711-16.....101	43820-10.....52
25137-11.....91	25660-14.....95	25730-21.....95	33711-20.....101	43821-10.....52
25140-13.....91	25661-12.....95	25730-21D.....95	33711-21.....101	43823-10.....52
25144-13.....91	25661-13.....95	25730-23.....95	33712-16.....101	43940-05.....53
25150-12.....92	25661-14.....95	25730-23D.....95	33713-17.....101	43940-08.....53
25150-14.....92	25668-18.....96	25731-12.....95	33718-16.....101	43942-05.....53
25154-12.....92	25668-21.....96	25731-13.....95	33719-17.....101	43942-08.....53
25154-14.....92	25668-23.....96	25731-14.....95	33720-19.....102	43950-10.....54
25160-15.....92	25670-14.....96	25731-18.....95	33720-21.....102	43952-10.....54
25160-18.....92	25670-18.....96	25731-18D.....95	34554-15.....97	43953-10.....54
25164-15.....92	25670-21.....96	25731-21.....95	34554-18.....97	44015-20.....55
25164-18.....92	25671-12D.....95	25731-21D.....95	34554-20.....97	44015-27.....55
25164-20.....92	25671-13D.....95	25731-23.....95	34555-15.....97	44076-05.....56
25164-23.....92	25671-14.....96	25731-23D.....95	34555-18.....97	44076-10.....56
25180-12.....92	25671-14D.....95	33100-01.....98	34555-20.....97	44078-05.....56

HADEO
 INSTRUMENTE GERMANY

 Nummernverzeichnis
 Numerical Index
 Índice numérico
 Indice numerico

44078-10.....56	47191-02119	47385-15.....125	47473-02.....130	47551-16.....87
44150-01.....55	47191-03119	47386-01.....125	47473-03.....130	47551-16L.....87
44150-03.....55	47191-04119	47386-02.....125	47474-01.....130	47552-16.....87
44150-05.....55	47192-16119	47390-03.....126	47474-02.....130	47553-15.....87
44150-10.....55	47195-01119	47390-04.....126	47474-03.....130	47554-01.....88
44150-15.....55	47195-02119	47390-05.....126	47475-04.....131	47554-02.....88
44254-09.....55	47197-01119	47392-03.....126	47475-06.....131	47554-03.....88
44256-09.....55	47197-02119	47392-04.....126	47475-08.....131	47555-08.....88
44258-09.....55	47223-01120	47392-05.....126	47481-05.....130	47556-16.....88
44425-10.....55	47223-02120	47394-27127	47482-05.....132	47557-17.....88
45201-1157	47223-03120	47410-04.....102	47484-04.....132	47558-15.....88
45206-14.....57	47223-04120	47410-05.....102	47484-06.....132	47559-20.....88
45206-16.....57	47223-05120	47411-16.....102	47484-08.....132	47560-18.....89
45208-14.....57	47224-01120	47414-21.....102	47486-16.....132	47562-18.....89
47102-01110	47224-02120	47415-18.....102	47487-16.....132	47563-22.....89
47102-02110	47224-03120	47417-19.....102	47489-16.....132	47564-16.....89
47102-03110	47224-04120	47419-19.....102	47502-16.....134	47565-10.....57
47103-01111	47224-05120	47420-01.....103	47504-18.....134	47566-12.....89
47103-02111	47225-01120	47420-02.....103	47507-17.....134	47567-11.....89
47103-03111	47225-02120	47420-03.....103	47507-18.....134	47568-08.....89
47112-01112	47225-03120	47420-04.....103	47511-21.....135	47571-23.....140
47112-02112	47225-04120	47420-20.....103	47513-21.....135	47572-23.....140
47112-03112	47226-01120	47421-21.....103	47514-16.....135	47573-23.....140
47116-13112	47226-02120	47421-23.....103	47516-16.....135	47575-23.....140
47118-13112	47226-03120	47422-22.....103	47518-21.....135	49115-01.....141
47120-35.....113	47227-01120	47423-22.....104	47520-21.....136	49115-02.....141
47120-35S.....114	47227-02120	47424-16.....104	47522-01.....137	49117-11.....141
47120-50.....113	47227-03120	47425-19.....104	47522-04.....137	49274-09.....141
47120-50S.....114	47237-01121	47426-22.....104	47522-05.....137	49274-11.....141
47120-75.....113	47237-02121	47428-21.....104	47522-07.....137	49274-13.....141
47120-75S.....114	47239-01121	47430-22.....104	47522-09.....137	49274-15.....141
47120-90.....113	47239-02121	47450-04.....128	47523-01.....134	49278-01.....105
47120-90S.....114	47242-00121	47451-04.....128	47523-02.....134	49278-02.....105
47124-35.....115	47242-01121	47454-04.....129	47524-01.....134	49280-18.....105
47124-35S.....116	47251-21122	47454-07.....129	47525-20.....134	49281-01.....106
47124-50.....115	47256-20122	47454-09.....129	47526-20.....134	49281-02.....106
47124-50S.....116	47323-19123	47454-12.....129	47530-00.....138	49310-00.....142
47124-75.....115	47325-19123	47455-06.....129	47530-01.....138	49310-01.....142
47124-75S.....116	47347-20109	47458-04.....129	47530-02.....138	49310-02.....142
47124-90.....115	47370-16124	47458-07.....129	47531-00.....138	49310-03.....142
47124-90S.....116	47371-16124	47458-09.....129	47532-19.....138	49310-04.....142
47151-15.....57	47372-16124	47458-12.....129	47533-19.....138	49310-05.....142
47151-18.....57	47373-16124	47460-04.....129	47534-19.....138	49310-09.....142
47154-20.....57	47374-16124	47460-07.....129	47535-01.....139	49310-10.....142
47158-20.....117	47375-16124	47460-12.....129	47535-02.....139	49310-11.....142
47159-20.....117	47375-19124	47461-00.....133	47538-01.....87	49310-12.....142
47161-16.....117	47376-16124	47462-00.....133	47538-02.....87	49315-00.....143
47161-20.....117	47379-16125	47463-10.....129	47538-03.....87	49315-01.....143
47169-18.....118	47380-15125	47463-12.....129	47538-04.....87	49315-02.....143
47185-18.....118	47382-15125	47463-14.....129	47540-16.....87	49315-03.....143
47191-01119	47384-15125	47473-01.....130	47550-11.....87	49315-10.....143

Nummernverzeichnis
Numerical Index
Indice numérico
Indice numerico**HADEO**
INSTRUMENTE GERMANY

49317-00.....143	49700-01.....151	R600-040175-030.....152
49317-01.....143	49700-02.....151	R600-100178-030.....152
49317-02.....143	55116-15.....90	R610-040175-001.....154
49317-03.....143	55117-17.....90	R610-040175-005.....155
49317-10.....143	55120-15.....90	R610-040175-070.....153
49320-00.....144	73193-30.....4	R610-040175-110.....153
49320-01.....144	93250-15T.....95	R610-040175-115.....153
49320-02.....144	93250-18T.....95	R631-030160-110.....156
49320-03.....144	93250-21T.....95	R631-030160-112.....156
49320-10.....144	93251-15T.....95	R631-030160-116.....156
49320-20.....144	93251-18T.....95	R631-030160-212.....157
49340-00.....144	93251-21T.....95	R631-030160-224.....157
49342-01.....145	93260-15T.....95	R631-030160-246.....157
49342-02.....145	93260-18T.....95	R660-050340-002.....158
49342-03.....145	93260-21T.....95	R660-050340-004.....158
49342-04.....145	93261-15T.....95	R661-050340-002.....158
49342-05.....145	93261-18T.....95	R661-050340-004.....158
49605-07.....146	93261-21T.....95	
49605-10.....146	93385-21.....12	
49605-11.....146	93385-25.....12	
49605-12.....146	93390-21.....12	
49605-14.....146		
49605-16.....146		
49610-12.....147		
49610-13.....147		
49610-16.....147		
49613-10.....148		
49615-12.....148		
49620-15.....148		
49623-16.....148		
49627-01.....148		
49630-02.....148		
49635-18.....149		
49640-05.....149		
49640-07.....149		
49640-09.....149		
49650-06.....149		
49650-07.....149		
49650-09.....149		
49650-11.....149		
49660-18.....150		
49666-10.....151		
49666-15.....151		
49666-20.....151		
49667-10.....151		
49667-15.....151		
49680-10.....150		
49680-20.....150		
49685-21.....150		
49691-15.....150		
49692-15.....150		

A	Blepharoplastik Schere, GREENBERG-PAR32	COTTLE, Stahlhammer100
ADSON, Arterienklemme64	Blepharoplastik Schere, KAYE32	COTTLE-JOSEPH, Septumlevator ..103
ADSON, Durahaken85	BÖHLER, Hohlmeißelzange98	COTTLE-KAZANJIAN, Knochensplitterzange99
ADSON, Pinzette38,39	BÖHLER, Knochensplitterzange ...99	COTTLE-MASING, Nasenschere ..27
ADSON, Saugrohr107	BOIES, Elevator.....102	COTTLE-NEIVERT, Hauthäkchen ..88
ADSON-BROWN, Pinzette40	BONN, Schere20	CRILE, Arterienklemme62
AGRIS-DINGMAN, Brustdissektor ..82	BONNEY, Pinzette45	CRILE, Nervhaken.....85
ALM, Wundhaken75	BREAST, Wundhaken.....79	CRILE, Wundhaken65
Anatomische Pinzette36	BROWN, Pinzette41	CRILE-RANKIN, Arterienklemme ..62
ANDERSON, Hauthäkchen79	BRUENINGS, Septumzange119	CRILE-WOOD, Nadelhalter92
ANDREW, Zungenspatel141	Brustdissektor, AGRIS-DINGMAN ..82	CRIONIN, Gaumenspalt-Messer ..105
Antrumraspel, WIENER134	Brustdissektor, SILVERSTEIN83	CUSHING (TAYLOR), Pinzette44
Arterienklemme, ROCHESTER-PEAN..63	Brustdissektor, TEBBETTS.....83	CUSHING, Pinzette.....41
Arterienklemme, ADSON.....64	Brustdissektor, MacCOLLUM-DINGMAN.....83	CUSHING, Nervenhaken85
Arterienklemme, COLLER-CRILE ..61	Brustspatel80	D
Arterienklemme, CRILE62	Bügel, McIVOR.....144	Darmspatel, RIBBON.....66
Arterienklemme, CRILE-RANKIN ..62	C	D'ASSUMPACO, Markierungsinstrument3
Arterienklemme, CRILE-RANKIN ..62	CAPLAN, Nasenzange122	DAVIS-BOYLE, Mundsperrerr.....142
Arterienklemme, HALSTED-MOSQUITO ..60	CASTROVIEJO, Meßinstrument4	DAVIS-BOYLE, Zungenspatel142
Arterienklemme, HARTMANN59	CASTROVIEJO, Meßzirkel.....4	DAVIS-MEYER, Mundsperrerr.....144
Arterienklemme, JACOBSON Micro ..60	CASTROVIEJO, Mikro-Nadelhalter ...96	DeBAKEY, Nadelhalter92
Arterienklemme, KELLY.....61	CASTROVIEJO, Nahtpinzette55	DEAVER, Wundhaken.....67
Arterienklemme, KELLY-RANKIN ..61	CHADWICK, Zahnfleischschere26	DeBAKEY, Atrauma Pinzette ..49,50,51
Arterienklemme, LERICHE63	Chalazionspinzette, DESMARRES...55	Delphinzange für plastische Endoskopie157
Arterienklemme, PROVIDENCE-HOSPITAL61	Chirurgische Pinzette.....37	DERF, Nadelhalter.....91
Arterienklemme, ROCHESTER-OCHSNER63	Cilienpinzette, BARRAQUER55	Dermatom, HUMBY6
ASCH, Septumrichtzange.....140	COLLER-CRILE, Arterienklemme..61	Dermatom, SCHINK5
Atrauma Pinzette, DeBAKEY ..47,48,51	COLLIER, Beckenzirkel.....4	Dermatom, SCHINK5
AUFRICHT, Nasenhaken.....87	COLLIN-DUVAL, Fußpinzette42	Dermatom, SILVER6
AUFRICHT, Nasenraspel.....135	Columella-Pinzette, COTTLE57	Dermatom, WATSON.....6
B	CONVERSE, Nasenhaken87,89	DESMARRES, Chalazionspinzette ...55
BABY OLSEN-HEGAR, Nadelhalter ..93	CONVERSE, Nasenmesser125	DESMARRES, Wundhaken.....73
BABY WEBSTER, Nadelhalter91	CONVERSE/WILMER/WALTER, Schere22	DINGMANN, Nasenraspel.....138
BALLENGER, Schwingmesser.....126	CORONAL, Wundhaken.....79	DINGMANN, Elevator150
BALLENGER, Septumlevator104	COTTLE, Columella-Pinzette57	DINGMANN, Mundsperrerr.....143
BARON, Saugrohr107	COTTLE, Fixierpinzette57	DINGMANN, Raspator.....150
BARRAQUER, Cilienpinzette55	COTTLE, Hauthäkchen88,89	DINGMANN, Sperrerr143
BARRAQUER, Nadelhalter95	COTTLE, Knorpelquetscher133	DINGMANN, Zungenspatel143
BARSKY, Hauthäkchen71	COTTLE, Nasenhaken87	Dissektor, GORNEY102
BAUMGARTNER, Nadelhalter92	COTTLE, Nasenmesser125	Drahtbürste138
BEASELEY BABCOCK, Pinzette ...39	COTTLE, Nasenschere27	Drahtzange TC, BERRY97
Beckenzirkel, COLLIER.....4	COTTLE, Nasenspekula115,116	Drahtzange TC, MAYO-HABERISSER.....97
BERKE, Muskelpinzette.....55	COTTLE, Osteotom129	Durahaken, ADSON.....85
BERRY, TC-Drahtzange97	COTTLE, Schere22	DURANTE, Fußpinzette45
BEUSE, Face-Lift-Schere31	COTTLE, Septumlevator103,104	DUVAL, Fußpinzette42
BEYER, Hohlmeißelzange.....98	COTTLE, Septummeißel129	
BIGGS, Wundhaken84	COTTLE, Septumosteotom129	
BISHOP-HARMAN, Irispinzette53		
BLAIR, Gaumenspalt-Elevator.....106		

E	FOMON, Nasenraspel136	HALSTED-MOSQUITO,
Elevator, BALLENGER104	FOMON, Nasenschere27	Arterienklemme60
Elevator, BOIES102	FOMON, Raspator101	Hammer100
Elevator, COTTLE-JOSEPH ..103,104	FRAZIER, Hauthäkchen70	Hammer, COTTLE100
Elevator, DINGMANN150	FRAZIER/FERGUSSON, Saugrohr ..108	Hammer, GERZOG100
Elevator, FREER102	FREEMAN, Markierungsinstrument4	Hammer, MEAD100
Elevator, HAJEK-BALLENGER104	FREEMAN, Wundhaken68,79,81	Hammer, PARTSCH100
Elevator, HOWARTH103	FREER, Hauthäkchen88	Hammer, QUISLING100
Elevator, JOSEPH102	FREER, Mukosamesser124	HARTMANN, Arterienklemme59
Elevator, KILLIAN103,104	FREER, Septumelevator102	HARTMANN, Nasenspekula111
Elevator, MASING102	FREER, Septumhohlmeißel132	HARTMANN, Polypenzange117
Elevator, McKENTY102,103	FREER, Septummeißel128	HARTMANN-HALLE,
Elevator, OBWEGESER149	FRIEDMANN, Hohlmeißelzange98	Nasenspekula110
Elevator, PENNINGTON103		Hauthäkchen, FRAZIER70
Elevator, PIERCE103	G	Hauthäkchen, ANDERSON79
Elevator, SINUS103	Gaumenspalt-Elevator, BLAIR106	Hauthäkchen, BARSKY71
Endo-Dissektor, LANGENBECK77	Gaumenspalt-Messer, CRIONIN ..105	Hauthäkchen, COTTLE88,89
Endo-Dissektor,	Gaumenspalter, Raspatorium105	Hauthäkchen, COTTLE-NEIVERT ..88
MINI-LANGENBECK77	Gefäßpinzette, STILLE-BARRAYA45	Hauthäkchen, FOMON88
Endo-Dissektor77	GERALD, Pinzette43,44	Hauthäkchen, FREER88
Endoskop152	GERZOG, Hammer100	Hauthäkchen, GILLIES89
Ersatzbacken f. Hammer100	Gewebefäßpinzette, SINGLEY45	Hauthäkchen, GRAEFE69
Ersatzklinge f. SCHINK Dermatome...5	GILLIES, Hauthäkchen89	Hauthäkchen, GUTHRIE69
Ersatzklingen f. Dermatome6	GILLIES, Nadelhalter94	Hauthäkchen, HUMBY71
	GILLIES, Pinzetten43	Hauthäkchen, JOSEPH70
F	GLABELLA, Nasenraspel134	Hauthäkchen, KLEINERT-KUTZ70
Face-Lift-Schere, BEUSE31	GOLDMAN-FOX, Zahnfleissschere ..29	Hauthäkchen, REDA72
Face-Lift-Schere, GORNEY30	Goniometer, Finger2	Hauthäkchen, TYRELL69
Face-Lift-Schere,	GORNEY, Dissektor102	HEYMANN, Nasenschere27
GORNEY-FREEMAN30	GORNEY, Face-Lift-Schere30	HEYMANN-KNIGHT, Polypenzange ..118
Face-Lift-Schere, KAYE31	GORNEY, Wundhaken81	Hohlmeißel, FREER132
Face-Lift-Schere, PECK-JOSEPH ..31	GORNEY-FREEMAN,	Hohlmeißel, HAJEK132
Fadenpinzette, OCHSNER45	Face-Lift-Schere30	Hohlmeißel, KILLIAN130
Fadenschere, LITTAUER28	GRADLE, Schere23	Hohlmeißel, KILLIAN-CLAUS132
Fadenschere, O'BRIEN28	GRAEFE, Hauthäkchen69	Hohlmeißel, WEST132
Fadenschere, SPENCER28	GRAEFE, Irispinzette52	Hohlmeißelzange, BEYER98
FARABEUF, Wundhaken65	GRAEFE, Pinzette41	Hohlmeißelzange, BÖHLER98
Faßpinzette, COLLIN-DUVAL42	GRAEFE, Schere22	Hohlmeißelzange, FRIEDMANN ...98
Faßpinzette, DURANTE45	GRAIG, Septumzange119	HOLZHEIMER, Wundsperrer75
Faßpinzette, DUVAL42	GREEN, Fixierpinzette56	HOWARTH, Septumelevator103
Faßpinzette, RUSS. MODELL42	GREENBERG-PAR,	HUMBY, Dermatome6
Faßzange f. plastische Endoskopie..157	Blepharoplastik Schere32	HUMBY, Hauthäkchen71
Faßzange, MARYLAND157	GUILLEN, Saugraspatorium109	
FERRIERA, Wundhaken78	GUTHRIE, Hauthäkchen69	I
FERRIS-SMITH, Pinzette42		IRIS, Schere20
Finger-Goniometer2	H	Irishäkchen, O'CONNOR86
FINSEN, Wundhaken75	HAJEK, Septumhohlmeißel132	Irishäkchen, WIENER86
Fixierpinzette, COTTLE57	HAJEK-BALLENGER,	Irispinzette, BISHOP-HARMAN53
Fixierpinzette, GREEN56	Septumelevator104	Irispinzette, GRAEFE52
Flachmeißel, MINI-LAMBOTTE132	Hakenschere für plastische	
FOERSTER, Kapselmesser127	Endoskopie156	
FOMON, Hauthäkchen88	HALSEY, Nadelhalter91	

J	L	M	MEAD, Hammer.....100
JACKSON, Trachealhaken90	LA GRANGE, Zahnfleissschere...26	MALINIAC, Nasenhaken87	Meißel, COTTLE.....129
JACOBSON Mikro, Arterienklemme...60	LAHEY, Wundhäkchen70	MALTZ (COTTLE), Nasenraspel ..135	Meißel, FREER.....128
JAEGER, Lidplatte.....58	LANDOLT, Skalpellgriff12	MALTZ, Nasenraspel134	Meißel, KILLIAN.....130
JAMESON, Präparierschere.....19	LANGE, Nasenflügelhäkchen.....89	Markierungsinstrument,	Meißel, MINI-LAMBOTTE.....132
JANSEN, Wundsperrerr.....75	LANGENBECK, Endo-Dissektor ...77	D'ASSUMPACO.....3	Meißel, SILVER.....130
JANSEN-GRUENWALD,	LANGENBECK, Raspator.....101	Markierungsinstrument, FREEMAN.....4	Meßinstrument, CASTROVIEJO4
Ohrpinzette.....57	LERCHE, Pinzette.....41	Markierungsinstrument, LOCKWOOD..3	Meßinstrument, COLLIER.....4
JENNINGS, Mundsperrerr.....141	LERICHE, Arterienklemme63	McKISSOCK.....4	Meßzirkel, CASTROVIEJO.....4
J-Haken Elektrode, monopolar.....158	LEXER, Präparierschere15	Markierungsinstrument, PITANGUY.....3	Metallmaßstab.....2
JOSEPH (LEWIS), Nasenraspel...135	LEXER BABY, Präparierschere15	MARTINEZ-KILNER, Wundhaken ..89	METZENBAUM, Präparierschere ..16,17
JOSEPH, Hauthäkchen.....70	Lidplatte, JAEGER.....58	MARYLAND, Faßzange für	METZENBAUM, Schere für
JOSEPH, Nasenmesser124,125	LITTAUER, Fadenschere.....28	plastische Endoskopie.....156	METZENBAUM-FINO,
JOSEPH, Nasenraspel.....134	LITTLER, Schere.....22	plästische Endoskopie.....156	Präparierschere.....17
JOSEPH, Nasensäge.....138,139	LOCKWOOD, Markierungsinstrument .3	MEYERDING, Wundhaken.....74	Micro HARTMANN, Arterienklemme...59
JOSEPH, Präparierschere.....18	LUBET-BARBON,	MICROVASCULAR, Nadelhalter ...93	MIDDLETON-JANSEN,
JOSEPH, Raspator.....101	Nasentamponzange.....117	Septumzange.....123	Septumzange.....123
JOSEPH, Septumelevator.....102	LUC, Septumzange.....119	Mikro Knüpppinzette.....47	Mikro Ringpinzetten.....48
JOST, Knorpelquetscher.....133	LUCAE, Ohrpinzette.....57	Mikro Nadelhalter, CASTROVIEJO ...96	Mikro Pinzette.....43
K	MacCOLLUM-DINGMAN,	Mikro Schere.....33,34,35	MILLER, Wundhäkchen86
Kapselmesser, FOERSTER.....127	Brustdissektor.....83	Mikro Schere.....33,34,35	MINI, Skalpellgriff.....10
KASDEN, Wundhaken.....73	M	Mikro Schere.....33,34,35	MINI, Skalpellklingen.....10
KAYE, Blepharoplastik-Schere.....32	MALINIAC, Nasenhaken87	Mikro Schere.....33,34,35	MINI-LAMBOTTE, Flachmeißel132
KAYE, Face-Lift-Schere.....31	MALTZ (COTTLE), Nasenraspel ..135	Mikro Schere.....33,34,35	MINI-LANGENBECK,
KELLY, Arterienklemme.....61	MALTZ, Nasenraspel134	Mikro Schere.....33,34,35	Endo-Dissektor.....77
KELLY, Präparierschere.....19	Markierungsinstrument,	Mikro Schere.....33,34,35	Mobilisierhaken, TESSIER.....150
KELLY-RANKIN, Arterieklemme.....61	D'ASSUMPACO.....3	Mikro Schere.....33,34,35	MOD. BONN, Nahtpinzette.....54
KILLIAN, Hohlmeißel.....130	Markierungsinstrument, FREEMAN.....4	Mikro Schere.....33,34,35	MOD.TUEBINGEN, Nahtpinzette ..54
KILLIAN, Nasenspekula.....113,114	Markierungsinstrument, LOCKWOOD..3	Mikro Schere.....33,34,35	MOD. WIEN, Nasenspekula.....112
KILLIAN, Septumelevator.....103,104	Markierungsinstrument,	Mikro Schere.....33,34,35	MOELTGEN, Winkelmesser.....2
KILLIAN-CLAUS, Septumhohlmeißel.132	McKISSOCK.....4	Mikro Schere.....33,34,35	Monopolare J-Haken-Elektrode ...158
KILNER, Nasenhaken.....88	Markierungsinstrument, PITANGUY.....3	Mikro Schere.....33,34,35	Monopolare Spatel-Elektrode.....158
KILNER, Präparierschere.....19	MARTINEZ-KILNER, Wundhaken ..89	Mikro Schere.....33,34,35	Mukosamesser, FREER.....124
KILNER-DOUGHTY, Mundsperrerr...143	MARYLAND, Faßzange für	Mikro Schere.....33,34,35	Mundsperrerr, DAVIS-BOYLE.....142
KILNER-DOUGHTY, Zungenspatel ..143	plastische Endoskopie.....157	Mikro Schere.....33,34,35	Mundsperrerr, DAVIS-MEYER.....144
KLAPP, Wundhaken72	MASING, Elevator.....102	Mikro Schere.....33,34,35	Mundsperrerr, DINGMANN.....143
KLEINERT-KUTZ, Hauthäkchen.....70	MASING-NEIVERT, Nasenhaken ...87	Mikro Schere.....33,34,35	Mundsperrerr, JENNINGS.....141
KNAPP, Schere.....21	Maßstab, Metall.....2	Mikro Schere.....33,34,35	Mundsperrerr, KILNER-DOUGHTY ..143
KNAPP, Tränenackhäkchen.....86	MAYO, Präparierschere.....13	Mikro Schere.....33,34,35	Mundsperrerr, McIVOR.....144
KNIGHT, Septumzange.....118	MAYO-HABERISSER,	Mikro Schere.....33,34,35	Muskelpinzette, BERKE.....55
Knochensplitterzange, BÖHLER ...99	TC-Drahtzange.....97	Mikro Schere.....33,34,35	MYLES, Nasenzange.....121
Knochensplitterzange, McINDOE...99	MAYO-HEGAR, Nadelhalter.....92	Mikro Schere.....33,34,35	
Knochensplitterzange,	MAYO-STILLE, Präparierschere....14	Mikro Schere.....33,34,35	
COTTLE-KAZANJIAN.....99	McINDOE, Knochensplitterzange ...99	Mikro Schere.....33,34,35	
Knorpelquetscher, COTTLE.....133	McINDOE, Knorpelschere.....29	Mikro Schere.....33,34,35	
Knorpelquetscher, JOST.....133	McINDOE, Pinzetten.....42	Mikro Schere.....33,34,35	
Knorpelschere, McINDOE.....29	McIVOR, Mundsperrerr.....144	Mikro Schere.....33,34,35	
Knüpppinzette, Mikro.....47	McIVOR, Bügel.....144	Mikro Schere.....33,34,35	
	McIVOR, Zungenspatel.....144	Mikro Schere.....33,34,35	
	McKENTY, Septumelevator ...102,103	Mikro Schere.....33,34,35	
	McKISSOCK, Markierungsinstrument .4	Mikro Schere.....33,34,35	

N			
Nadelhalter, BABY OLSEN-HEGAR	93	Nasentamponzange, LUBET-BARBON	117
Nadelhalter, BABY WEBSTER	91	Nasentamponzange, WESTMACOTT	117
Nadelhalter, BARRAQUER	95	Nasenzange, CAPLAN	122
Nadelhalter, BAUMGARTNER	92	Nasenzange, MYLES	121
Nadelhalter, CRILE-WOOD	92	Nasenzange, SCHMEDEN	121
Nadelhalter, DeBAKEY	92	Nasenzange, TAKAHASHI	121
Nadelhalter, DERF	91	Nasenzange, WEIL-BLAKESLEY	120
Nadelhalter, GILLIES	94	NEIVERT-ANDERSON, Osteotom	130
Nadelhalter, HALSEY	91	Nervhaken	77
Nadelhalter, MAYO-HEGAR	92	Nervhaken, CRILE	85
Nadelhalter, MICROVASCULAR	93	Nervhaken, CUSHING	85
Nadelhalter, Mikro, Titan	95	NEWS, Trachealhaken	90
Nadelhalter, OLSEN-HEGAR	93		
Nadelhalter, RYDER	93	O	
Nadelhalter, WEBSTER	91	O'BRIEN, Fadenschere	28
Nahtpinzette, CASTROVIEJO	55	OBWEGESER, Osteotom	131
Nahtpinzette, MOD. BONN	54	OBWEGESER, Raspator	149
Nahtpinzette, MOD. TUEBINGEN	54	OBWEGESER, Wundhaken	146, 147, 148
Nasenflügelhäkchen, LANGE	89	OCHSNER, Fadenpinzette	45
Nasenhaken, AUFRICHT	87	O'CONNOR, Irishäkchen	86
Nasenhaken, CONVERSE	87, 89	OEHLER, chirurgische Pinzette	37
Nasenhaken, COTTLE	87	Ohrpinzette, JANSEN-GRUENWALD	57
Nasenhaken, KILNER	88	Ohrpinzette, LUCAE	57
Nasenhaken, MALINIAC	87	Ohrpinzette, TROELTSCH	57
Nasenhaken, MASING-NEIVERT	87	Ohrpinzette, WILDE (TROELTSCH)	57
Nasennmesser, CONVERSE	125	OLSEN-HEGAR, Nadelhalter	93
Nasennmesser, COTTLE	125	Ophthalmologie Schere	23
Nasennmesser, JOSEPH	124, 125	Optik f. plastische Endoskopie	152
Nasenraspel, AUFRICHT	135	Osteotom	151
Nasenraspel, DINGMAN	138	Osteotom, COTTLE	129
Nasenraspel, FOMON	136, 137	Osteotom, NEIVERT-ANDERSON	130
Nasenraspel, GLABELLA	134	Osteotom, OBWEGESER	131
Nasenraspel, JOSEPH	134	Osteotom, RUBIN	129
Nasenraspel, JOSEPH (LEWIS)	135	Osteotom, TESSIER	151
Nasenraspel, MALTZ	134	Osteotom, WEST	132
Nasenraspel, MALTZ (COTTLE)	135		
Nasenraspel, PARKES	134	P	
Nasenraspel, PEET	134	PARKES, Nasenraspel	134
Nasensäge, JOSEPH	138, 139	PARTSCH, Hammer	100
Nasenschere, COTTLE	27	PECK-JOSEPH, Face-Lift-Schere	31
Nasenschere, COTTLE-MASING	27	PEET, Nasenraspel	134
Nasenschere, FOMON	27	PENNINGTON, Septumlevator	103
Nasenschere, HEYMANN	27	PIERCE, Septumlevator	103
Nasenspekula, HARTMANN-HALLE	110	Pinzette, CUSHING (TAYLOR)	44
Nasenspekula, COTTLE	115, 116	Pinzette, ADSON	38, 39
Nasenspekula, HARTMANN	111	Pinzette, ADSON-BROWN	40
Nasenspekula, KILLIAN	113, 114	Pinzette, anatomisch	36
Nasenspekula, Mod. WIEN	112	Pinzette, BARRAQUER	55
Nasenspekula, REDA	112	Pinzette, BEASELEY BABCOCK	39
Nasenspekula, TIECK-HALLE	112	Pinzette, BERKE	55
		Pinzette, BISHOP-HARMAN	53
		Pinzette, BONNEY	45
		Pinzette, BROWN	41
		Pinzette, CASTROVIEJO	55
		Pinzette, chirurgisch	37
		Pinzette, COLLIN-DUVAL	42
		Pinzette, COTTLE	57
		Pinzette, CUSHING	41
		Pinzette, DeBAKEY	48, 50, 51
		Pinzette, DESMARRRES	55
		Pinzette, DURANTE	45
		Pinzette, DUVAL	42
		Pinzette, FERRIS-SMITH	42
		Pinzette, GERALD	43, 44
		Pinzette, GILLIES	43
		Pinzette, GRAEFE	41, 52
		Pinzette, GREEN	56
		Pinzette, JANSEN-GRUENWALD	57
		Pinzette, LERCHE	41
		Pinzette, LUCAE	57
		Pinzette, McINDOE	42
		Pinzette, MOD. BONN	54
		Pinzette, MOD. TUEBINGEN	54
		Pinzette, OCHSNER	45
		Pinzette, OEHLER	37
		Pinzette, POTTS-SMITH	36
		Pinzette, RUSS. MODELL	42
		Pinzette, SEMKEN	43
		Pinzette, SINGLEY	45
		Pinzette, STILLE	36, 37
		Pinzette, STILLE-BARRAYA	45
		Pinzette, TAYLOR	44
		Pinzette, TROELTSCH	57
		Pinzette, USA	36, 37
		Pinzette, WAUGH	41
		Pinzette, WILDE (TROELTSCH)	57
		PITANGUY, Markierungsinstrument	3
		Polypenzange, HARTMANN	117
		Polypenzange, HEYMANN-KNIGHT	118
		POTTS-SMITH, Pinzette	36
		Präparierschere, JAMESON	19
		Präparierschere, JOSEPH	18
		Präparierschere, KELLY	19
		Präparierschere, KILNER	19
		Präparierschere, LEXER	15
		Präparierschere, LEXER BABY	15
		Präparierschere, MAYO	13
		Präparierschere, MAYO-STILLE	14
		Präparierschere, METZENBAUM	16, 17

Präparierschere, METZENBAUM FINO.....17	S	SCHMEDEN, Nasenzange.....121
Präparierschere, RAGNELL.....19	SANVENERO, Präparierschere.....18	Schwingmesser, BALLENGER.....126
Präparierschere, REYNOLDS.....19	Saugraspatorium, GUILLEN.....109	SEMKEN, Pinzetten.....43
Präparierschere, SANVENERO.....18	Saugrohr, ADSON.....107	Septumelevator, BALLENGER.....104
PROVIDENCE-HOSPITAL, Arterienklemme.....61	Saugrohr, FRAZIER/FERGUSSON..108	Septumelevator, COTTLE.....103,104
	Saugrohr, BARON.....107	Septumelevator, COTTLE-JOSEPH.....103
	Schaft f. plastische Endoskopie153,154,155	Septumelevator, FREER.....102
Q	Schere f. plastische Endoskopie ..156	Septumelevator, HAJEK-BALLENGER.....104
QUISLING, Hammer.....100	Schere, BEUSE.....31	Septumelevator, HOWARTH.....103
	Schere, BONN.....20	Septumelevator, JOSEPH.....102
R	Schere, CHADWICK.....26	Septumelevator, KILLIAN.....103,104
RAGNELL, Präparierschere.....19	Schere, CONVERSE/WILMER.....22	Septumelevator, McKENTY...102,103
RAGNELL, Wundhaken.....65	Schere, COTTLE.....22,27	Septumelevator, PENNINGTON...103
RAMUS, Wundhaken.....148	Schere, COTTLE-MASING.....27	Septumelevator, PIERCE.....103
Rasierklängen, unsteril.....6	Schere, FOMON.....27	Septumelevator, SINUS.....103
Raspator, DINGMANN.....150	Schere, GOLDMAN-FOX.....29	Septumhohlmeißel, FREER.....132
Raspator, FOMON.....101	Schere, GORNEY.....30	Septumhohlmeißel, HAJEK.....132
Raspator, JOSEPH.....101	Schere, GORNEY-FREEMAN.....30	Septumhohlmeißel, KILLIAN-CLAUS.....132
Raspator, LANGENBECK.....101	Schere, GRADLE.....23	Septummeißel, COTTLE.....129
Raspator, OBWEGESER.....149	Schere, GRAEFE.....22	Septummeißel, FREER.....128
Raspator, WILLIGER.....101	Schere, GREENBERG-PAR.....32	Septummeißel, SILVER.....130
Raspatorium, Gaumenspalter.....105	Schere, HEYMANN.....27	Septumosteotom, COTTLE.....129
Raspel, AUFRICHT.....135	Schere, IRIS.....20	Septumrichtzange, ASCH.....140
Raspel, DINGMAN.....138	Schere, JAMESON.....19	Septumrichtzange, WALSHAM.....140
Raspel, FOMON.....136,137	Schere, JOSEPH.....18	Septumzange, BRUENINGS.....119
Raspel, JOSEPH (LEWIS).....135	Schere, KAYE.....31,32	Septumzange, GRAIG.....119
Raspel, MALTZ (COTTLE).....135	Schere, KELLY.....19	Septumzange, KNIGHT.....118
Raspel, PARKES.....134	Schere, KILNER.....19	Septumzange, LUC.....119
Raspel, PEET.....134	Schere, KNAPP.....21	Septumzange, MIDDLETON-JANSEN.....123
Raspel, WIENER.....134	Schere, LA GRANGE.....26	Septumzange, RUBIN.....122
REDA, Hauthäkchen.....72	Schere, LEXER.....15	Sichelmesser, REDA.....125
REDA, Nasenspekula.....112	Schere, LEXER BABY.....15	Silikon-Schlauch.....6
REDA, Sichelmesser.....125	Schere, LITTAUER.....28	SILVER, Dermatom.....130
REYNOLDS, Präparierschere.....19	Schere, LITTLER.....22	SILVERSTEIN, Brustdissektor.....83
RIBBON, Darmspatel.....66	Schere, MAYO.....13	SINGLEY, Gewebefußpinzette.....45
Ringpinzette, Mikro.....49	Schere, MAYO-STILLE.....14	SINUS, Septumelevator.....103
ROCHESTER-OCHSNER, Arterienklemme.....63	Schere, McINDOE.....29	Skalpеллgriff, LANDOLT.....12
ROCHESTER-PEAN, Arterienklemme.....63	Schere, METZENBAUM.....16,17	Skalpеллgriff, Mini.....10
ROLLET, Tränensackhäkchen.....86	Schere, METZENBAUM-FINO.....17	Skalpеллklingen, Mini.....10
ROUX MINI, Wundhaken.....65	Schere, Mikro.....33,34,35	Skalpеллklingen, steril.....11
RUBIN, Osteotom.....129	Schere, O'BRIEN.....28	Skalpеллklingen-Entferner.....11
RUBIN, Septumzange.....122	Schere, Ophthalmologie.....23	Spannplatte.....5
RUSS. MODELL, Fußpinzette.....42	Schere, PECK-JOSEPH.....31	Spatel.....80
RUSSEL-DAVIS, Zungenspatel.....145	Schere, RAGNELL.....19	Spatel-Elektrode, monopolar.....158
RYDER, Nadelhalter.....93	Schere, REYNOLDS.....19	SPENCER, Fadenschere.....28
	Schere, SANVENERO.....18	Sperrer, DAVIS-BOYLE.....142
	Schere, SPENCER.....28	Sperrer, DINGMANN.....143
	Schere, STEVENS.....24	
	Schere, STRABISMUS.....24	
	Schere, WAGNER.....25	
	SCHINK, Dermatom.....5	

Index Deutsch

HADEO
INSTRUMENTE GERMANY

Sperrer, KILNER-DOUGHTY143	W	Wundhaken, MEYERDING.....74
SPINA-NASALIS, Wundhaken148	WAGNER, Schere25	Wundhaken, OBWEGESER146,147,148
Splitterpinzetten46	WALSHAM, Septumrichtzange.....140	Wundhaken, RAGNELL.....65
Stahlhammer, COTTLE.....100	WALTER/CONVERSE/WILMER, Schere22	Wundhaken, RAMUS.....148
STEVENS, Schere.....24	WATSON, Dermatome.....6	Wundhaken, ROUX MINI.....65
STILLE, Pinzette36,37	WAUGH, Pinzette41	Wundhaken, SPINA-NASALIS148
STILLE-BARRAYA, Gefäßpinzette45	WEBSTER, Nadelhalter.....91	Wundhaken, STRANDELL-STILLE ...74
STRABISMUS, Schere.....24	WEIL-BLAKESLEY, Nasenzange .120	Wundhaken, TEBBETTS78
STRANDELL-STILLE, Wundhaken74	WEITLANER, Wundsperrer76	Wundhaken, VOLKMANN73
T	WEST, Hohlmeißel.....132	Wundhaken, YANKOSKIE79
TAKAHASHI, Nasenzange121	WEST, Osteotom132	Wundsperrer, HOLZHEIMER.....75
Tamponzange, LUBET-BARBON..117	WESTMACOTT, Nasentamponzange117	Wundsperrer, WEITLANER.....76
Tamponzange, WESTMACOTT...117	WIENER, Zungenspatel.....141	Wundsperrer, JANSEN.....75
TAYLOR, Pinzette44	WIENER, Antrumraspel134	Y
TC-Drahtzange, BERRY97	WIENER, Irishäkchen86	YANKOSKIE, Wundhaken79
TC-Drahtzange, MAYO-HABERISSER97	WILDE (TROELTSCH), Ohrpinzette...57	Z
TC-Nasenraspel, FOMON137	WILLIGER, Raspator101	Zahnfleischschere, CHADWICK.....26
TC-Nasenraspel, MALTZ (COTTLE) 135	WILMER/CONVERSE/WALTER, Schere22	Zahnfleischschere, GOLDMAN-FOX.....29
TEBBETTS, Brustdissektor83	Winkelmesser, MOELTGEN2	Zahnfleischschere, LA GRANGE...26
TEBBETTS, Wundhaken.....78	Wundhäkchen, BARSKY71	Zungenspatel, ANDREW141
TESSIER, Mobilisierhaken150	Wundhäkchen, COTTLE.....88,89	Zungenspatel, DAVIS-BOYLE142
TESSIER, Osteotom.....151	Wundhäkchen, COTTLE-NEIVERT...88	Zungenspatel, DINGMANN143
TIECK-HALLE, Nasenspekula112	Wundhäkchen, FOMON88	Zungenspatel, KILNER-DOUGHTY.....143
Titan Mikro Nadelhalter.....95,96	Wundhäkchen, FREER.....88	Zungenspatel, McIVOR144
Trachealhaken, JACKSON90	Wundhäkchen, GILLIES89	Zungenspatel, RUSSEL-DAVIS...145
Trachealhaken, NEWS90	Wundhäkchen, HUMBY71	Zungenspatel, WIEDER.....141
Tränensackhäkchen, KNAPP86	Wundhäkchen, KNAPP.....86	
Tränensackhäkchen, ROLLET86	Wundhäkchen, LAHEY70	
TROELTSCH, Ohrpinzette.....57	Wundhäkchen, MILLER.....86	
TYRELL, Hauthäkchen69	Wundhäkchen, O'CONNOR86	
U	Wundhäkchen, ROLLET86	
Uhrmacherpinzette46	Wundhäkchen, WIENER86	
USA, Pinzette36,37	Wundhaken.....150	
V	Wundhaken, ALM75	
VOLKMANN, Wundhaken73	Wundhaken, ANDERSON79	
	Wundhaken, BIGGS84	
	Wundhaken, BREAST79	
	Wundhaken, CORONAL.....79	
	Wundhaken, CRILE65	
	Wundhaken, DEEVER67	
	Wundhaken, DESMARRES.....73	
	Wundhaken, FARABEUF.....65	
	Wundhaken, FERRIERA78	
	Wundhaken, FINSSEN75	
	Wundhaken, FREEMAN68,79,81	
	Wundhaken, GORNEY81	
	Wundhaken, KASDEN.....73	
	Wundhaken, KLAPP72	
	Wundhaken, MARTINEZ-KILNER .89	

A

ADSON, dressing forceps.....38
 ADSON, tissue forceps.....38, 39
 ADSON, forceps.....64
 ADSON, hook.....85
 ADSON, suction tube.....107
 ADSON-BROWN, tissue forceps...40
 ADSON-DeBAKEY, dressing forceps...38
 AGRIS-DINGMAN, dissector.....82
 ALM, retractor.....75
 ANDERSON, retractor.....79
 ANDREW, tongue depressor.....141
 ASCH, septum straightening
 forceps.....140
 atrauma forceps, DeBAKEY...49, 50, 51
 AUFRICHT, retractor.....87
 AUFRICHT, nasal rasp.....135

B

BABY OLSEN-HEGAR,
 needle holder.....93
 BALLENGER, elevator.....104
 BALLENGER, knife.....126
 BARON, suction tube.....107
 BARRAQUER, cilia forceps.....55
 BARRAQUER, needle holder.....95
 BARSKY, retractor.....71
 BAUMGARTNER, needle holder...92
 BEASELEY BABCOCK,
 tissue forceps.....39
 BERKE, muscle forceps.....55
 BERRY, wire twisting forceps.....97
 BEUSE, scissors.....31
 BEYER, rongeur.....98
 BIGGS, retractor.....84
 BISHOP-HARMAN, iris forceps...53
 blades, scalpel.....11
 BLAIR, lip and cleft palate
 instrument.....106
 BÖHLER, rongeur.....98
 BÖHLER, bone cutting forceps...99
 BOIES, elevator.....102
 bone cutting forceps, BÖHLER...99
 bone cutting forceps,
 COTTLE-KAZANJIAN.....99
 bone cutting forceps, MC INDOE...99
 BONN, scissors.....20
 BONNEY, tissue forceps.....45
 BREAST, retractor.....79
 breast, spatula.....80
 BROWN, tissue forceps.....41
 BRUENINGS, septum forceps.....119

C

caliper, CASTROVIEJO.....4
 CAPLAN, nasal cutting forceps...122
 cartilage crusher, COTTLE.....133
 cartilage crusher, JOST.....133
 CASTROVIEJO, caliper.....4
 CASTROVIEJO, suture forceps...55
 CASTROVIEJO, needle holder...96
 CHADWICK, scissors.....26
 chalazion forceps, DESMARRES...55
 chisel, COTTLE.....129
 chisel, WEST.....132
 cilia forceps, BARRAQUER.....55
 COLLER-CRILE, forceps.....61
 COLLIER, pelvimeter.....4
 COLLIN-DUVAL, tissue forceps...42
 columella forceps, COTTLE.....57
 CONVERSE, retractor.....87
 CONVERSE, retractor.....89
 CONVERSE, knife.....125
 CONVERSE/WILMER/WALTER,
 scissors.....22
 CORONAL, retractor.....79
 COTTLE, scissors.....22, 27
 COTTLE, ear forceps.....57
 COTTLE, columella forceps.....57
 COTTLE, retractor.....87, 88, 89
 COTTLE, mallet.....100
 COTTLE, elevator.....103, 104
 COTTLE, nasal specula.....115, 116
 COTTLE, knife.....125
 COTTLE, osteotome.....129
 COTTLE, chisel.....129
 COTTLE, cartilage crusher.....133
 COTTLE JOSEPH, elevator.....103
 COTTLE-KAZANJIAN, bone
 cutting forceps.....99
 COTTLE-MASING, scissors.....27
 COTTLE-NEIVERT, retractor.....88
 CRILE, forceps.....62
 CRILE, retractor.....65
 CRILE, hook.....85
 CRILE-RANKIN, forceps.....62
 CRILE-WOOD, needle holder...92
 CRONIN, lip and cleft palate
 instrument.....105
 CUSHING, hook.....85
 CUSHING, tissue forceps.....41
 CUSHING-TAYLOR,
 dressing forceps.....44

D

D'ASSUMPACO, facelift marker.....3
 DAVIS-BOYLE, mouth gag.....142
 DAVIS-MEYER, mouth gag.....144
 DEAVER, retractor.....67
 DeBAKEY, atrauma forceps...49, 50, 51
 DeBAKEY, needle holder.....92
 DERF, needle holder.....91
 dermatome, HUMBY.....6
 dermatome, SCHINK.....5
 dermatome, SILVER.....6
 dermatome, WATSON.....6
 DESMARRES, chalazion forceps...55
 DESMARRES, retractor.....73
 DINGMAN, nasal rasp.....138
 DINGMANN, mouth gag.....143
 DINGMANN, elevator.....150
 dissector, AGRIS-DINGMAN.....82
 dissector, GORNEY.....102
 dissector, LANGENBECK.....77
 dissector, LANGENBECK-COTTLE...77
 dissector, MacCOLLUM-DINGMAN...83
 dissector, MINI-LANGENBECK...77
 dissector, SILVERSTEIN.....83
 DOLPHIN, endoscopic grasper...157
 dressing, forceps.....36, 37, 43
 dressing forceps, ADSON.....38
 dressing forceps,
 ADSON-DeBAKEY.....38
 dressing forceps,
 CUSHING-TAYLOR.....44
 dressing forceps, GERALD.....43, 44
 dressing forceps, McINDOE.....42
 dressing forceps, OCHSNER.....45
 dressing forceps, POTTS-SMITH...36
 dressing forceps, SEMKEN.....43
 dressing forceps, SINGLEY.....45
 dressing forceps, STILLE.....36
 dressing forceps, TAYLOR.....44
 dressing forceps, USA.....36
 DURANTE, tissue forceps.....45
 DUVAL, tissue forceps.....42

E

ear forceps, COTTLE.....57
 ear forceps,
 JANSEN-GRUENWALD.....57
 ear forceps, LUCAE.....57
 ear forceps, TROELTSCH.....57
 ear forceps, WILDE (TROELTSCH)...57
 ear polypus forceps, HARTMANN...117
 elevator, BALLENGER.....104

Index English

HADEO
INSTRUMENTE GERMANY

- elevator, BOIES102
elevator, COTTLE103, 104
elevator, COTTLE JOSEPH103
elevator, DINGMANN150
elevator, FREER102
elevator, FREER128
elevator, HAJEK-BALLENGER104
elevator, HOWARTH103
elevator, JOSEPH102
elevator, KILLIAN103, 104
elevator, LANGENBECK101
elevator, MASING102
elevator, McKENTY102, 103
elevator, OBWEGESER149
elevator, PENNINGTON103
elevator, PIERCE103
elevator, WILLIGER101
endoscope, plastic surgery153
endoscope shaft,
plastic surgery153, 154, 155
endoscopic, heavy grasper157
endoscopic, hook scissors156
endoscopic grasper, DOLPHIN157
endoscopic grasper,
MARYLAND157
endoscopic scissors,
METZENBAUM156
- F**
facelift marker, D'ASSUMPACO3
facelift marker, LOCKWOOD3
facelift marker, PITANGUY3
FARABEUF, retractor65
FERRIERA, retractor78
FERRIS-SMITH, tissue forceps42
finger, goniometer2
FINSSEN, retractor75
fixation forceps, GREEN56
FOERSTER, knife127
FOMON, scissors27
FOMON, retractor88
FOMON, raspatory101
FOMON, nasal rasp136, 137
FOMON, nasal rasp137
forceps, ADSON64
forceps, COLLIER-CRILE61
forceps, CRILE62
forceps, CRILE-RANKIN62
forceps, dressing36, 37, 43
forceps, HALSTED-MOSQUITO60
forceps, HARTMANN59
forceps, KELLY61
forceps, KELLY-RANKIN61
forceps, LERICHE63
forceps, micro suture tying47
forceps, micro ring48
forceps, MICRO-HARTMANN59
forceps, PROVIDENCE-HOSPITAL61
forceps, ROCHESTER-OCHSNER63
forceps, ROCHESTER-PEAN63
forceps, splinter46
forceps, tissue36, 37
FRAZIER/FERGUSSON,
suction tube108
FREEMAN, marker4
FREEMAN, retractor68, 79, 81
FREER, retractor88
FREER, elevator102
FREER, knife124
FREER, elevator128
FREER, gouge132
FRIEDMANN, rongeur98
FRIEDMANN MINI, rongeur98
- G**
GERALD, dressing forceps43, 44
GERALD, tissue forceps44
GERZOG, mallet100
GILLIES, tissue forceps43
GILLIES, retractor89
GILLIES, needle holder94
GLABELLA, nasal rasp134
GOLDMAN-FOX, scissors29
goniometer, finger2
goniometer, MOELTGEN2
GORNEY, scissors30
GORNEY, retractor81
GORNEY, dissector102
GORNEY-FREEMAN, scissors30
gouge, FREER132
gouge, HAJEK132
gouge, KILLIAN130
gouge, KILLIAN-KLAUS132
gouge, WEST132
GRADLE, scissors23
GRAEFE, scissors22
GRAEFE, tissue forceps41
GRAEFE, iris forceps52
GRAEFE, retractor69
GRAIG, septum forceps119
GREEN, fixation forceps56
GREENBERG-PAR, scissors32
GUILLEN, suction tube109
GUTHRIE, retractor69
- H**
HAJEK, gouge132
HAJEK-BALLENGER, elevator104
HALSEY, needle holder91
HALSTED-MOSQUITO, forceps60
handles, scalpel7, 8, 9, 10, 12
HARTMANN, forceps59
HARTMANN, nasal specula111
HARTMANN, ear polypus forceps117
HARTMANN-HALLE,
nasal specula110
heavy grasper, endoscopic157
HEYMAN, scissors27
HEYMANN-KNIGHT,
nasal forceps118
HOLZHEIMER, retractor75
hook, ADSON85
hook, CRILE85
hook, CUSHING85
hook, JACKSON90
hook, nerve77
hook, NEWS90
hook scissors, endoscopic156
HOWARTH, elevator103
HUMBY, dermatome6
HUMBY, retractor71
- I**
IRIS, scissors20
iris forceps, BISHOP-HARMAN53
iris forceps, GRAEFE52
- J**
JACKSON, hook90
JAEGER, lid plate58
JANSEN, retractor75
JANSEN-GRUENWALD,
ear forceps57
JENNINGS, tongue depressor141
J-Hook electrode, monopolar158
JOSEPH, scissors18
JOSEPH, retractor70
JOSEPH, raspatory101
JOSEPH, elevator102
JOSEPH, knife124, 125
JOSEPH, nasal rasp134
JOSEPH, nasal saw138, 139
JOSEPH (LEWIS), nasal rasp135
JOST, cartilage crusher133

K

KASDAN, retractor.....	73
KAYE, scissors.....	31, 32
KELLY, scissors.....	19
KELLY, forceps.....	61
KELLY-RANKIN, forceps.....	61
KILLIAN, elevator.....	103, 104
KILLIAN, nasal specula.....	113, 114
KILLIAN, gouge.....	130
KILLIAN-KLAUS, gouge.....	132
KILNER, scissors.....	19
KILNER, retractor.....	88
KILNER-DOUGHTY, mouth gag...	143
KLAPP, retractor.....	72
KLEINERT-KUTZ, retractor.....	70
KNAPP, scissors.....	21
KNAPP, retractor.....	86
knife, BALLENGER.....	126
knife, CONVERSE.....	125
knife, COTTLE.....	125
knife, FOERSTER.....	127
knife, FREER.....	124
knife, JOSEPH.....	124, 125
knife, REDA.....	125
KNIGHT, nasal forceps.....	118

L

LA GRANGE, scissors.....	26
LAHEY, retractor.....	70
LANGE, retractor.....	89
LANGENBECK, dissector.....	77
LANGENBECK, elevator.....	101
LANGENBECK-COTTLE, dissector...	77
LERCHE, tissue forceps.....	41
LERICHE, forceps.....	63
LEXER, scissors.....	15
LEXER-BABY, scissors.....	15
lid plate, JAEGER.....	58
lip and cleft palate instrument, ...	105
lip and cleft palate instrument, ...	106
lip and cleft palate instrument, ...	105
BLAIR.....	106
lip and cleft palate instrument, ...	105
CRONIN.....	105
LITTAUER, scissors.....	28
LITTLER, scissors.....	22
LOCKWOOD, facelift marker.....	3
LUBET-BARBON, nasal forceps...	117
LUC, septum forceps.....	119
LUCAE, ear forceps.....	57

M

MacCOLLUM-DINGMAN, dissector ...	83
MALINIAC, retractor.....	87
mallet, COTTLE.....	100
mallet, GERZOG.....	100
mallet, MEAD.....	100
mallet, nylon cap.....	100
mallet, PARTSCH.....	100
mallet, QUISLING.....	100
MALTZ, nasal rasp.....	134
MALTZ (COTTLE), nasal rasp.....	135
marker, FREEMAN.....	4
marker, McKISSOCK.....	4
MARYLAND, endoscopic grasper ...	157
MASING, elevator.....	102
MASING-NEIVERT, retractor.....	87
MAYO, scissors.....	13
MAYO-HABERISSER, wire ...	97
twisting forceps.....	97
MAYO-HEGAR, needle holder.....	92
MAYO-STILLE, scissors.....	14
MC INDOE, scissors.....	29
MC INDOE, bone cutting forceps ...	99
McINDOE, tissue forceps.....	42
McINDOE, dressing forceps.....	42
McIVOR, mouth gag.....	144
McKENTY, elevator.....	102, 103
McKISSOCK, marker.....	4
MEAD, mallet.....	100
metal, ruler.....	2
METZENBAUM, scissors.....	16, 17
METZENBAUM, ...	156
endoscopic scissors.....	156
METZENBAUM-FINO, scissors.....	17
MEYERDING, retractor.....	74
micro, scissors.....	33, 34, 35
micro suture tying, forceps.....	47
micro ring, forceps.....	48
MICRO-HARTMANN, forceps.....	59
MICROVASCULAR, needle holder....	93
MIDDLETON-JANSEN, ...	123
septum forceps.....	123
MILLER, retractor.....	86
MINI-LAMBOTTE, osteotome.....	132
MINI-LANGENBECK, dissector.....	77
MOD. BONN, suture forceps.....	54
MOD. TUEBINGEN, suture forceps...	54
Mod. WIEN, nasal specula.....	112
MOELTGEN, goniometer.....	2
monopolar, J-Hook electrode.....	158
monopolar, Spatula electrode.....	158
mouth gag, DAVIS-BOYLE.....	142

mouth gag, DAVIS-MEYER.....	144
mouth gag, DINGMANN.....	143
mouth gag, KILNER-DOUGHTY ..	143
mouth gag, McIVOR.....	144
muscle forceps, BERKE.....	55
MYLES, nasal cutting forceps.....	121

N

nasal cutting forceps, CAPLAN ...	122
nasal cutting forceps, MYLES.....	121
nasal cutting forceps, ...	121
SCHMEDEN.....	121
nasal cutting forceps, ...	121
TAKAHASHI.....	121
nasal cutting forceps, ...	120
WEIL-BLAKESLEY.....	120
nasal forceps, ...	118
HEYMANN-KNIGHT.....	118
nasal forceps, KNIGHT.....	118
nasal forceps, LUBET-BARBON...	117
nasal forceps, WESTMACOTT.....	117
nasal rasp, AUFRICHT.....	135
nasal rasp, DINGMAN.....	138
nasal rasp, FOMON.....	136, 137
nasal rasp, FOMON.....	137
nasal rasp, GLABELLA.....	134
nasal rasp, JOSEPH.....	134
nasal rasp, JOSEPH (LEWIS).....	135
nasal rasp, MALTZ.....	134
nasal rasp, MALTZ (COTTLE).....	135
nasal rasp, PARKES.....	134
nasal rasp, PEET.....	134
nasal rasp, WIENER.....	134
nasal rasp, wire brush.....	138
nasal saw, JOSEPH.....	138, 139
nasal specula, COTTLE.....	115, 116
nasal specula, HARTMANN.....	111
nasal specula, ...	110
HARTMANN-HALLE.....	110
nasal specula, KILLIAN.....	113, 114
nasal specula, Mod. WIEN.....	112
nasal specula, REDA.....	112
nasal specula, TIECK-HALLE.....	112
needle holder, ...	93
BABY OLSEN-HEGAR.....	93
needle holder, BARRAQUER.....	95
needle holder, BAUMGARTNER...	92
needle holder, CASTROVIEJO.....	96
needle holder, CRILE-WOOD.....	92
needle holder, DeBAKEY.....	92
needle holder, DERF.....	91
needle holder, GILLIES.....	94

Index English

HADEO
INSTRUMENTE GERMANY

- needle holder, HALSEY91
 needle holder, MAYO-HEGAR.....92
 needle holder, MICROVASCULAR.....93
 needle holder, OLSEN-HEGAR.....93
 needle holder, RYDER93
 needle holder, WEBSTER91
 NEIVERT-ANDERSON,
 osteotome.....130
 nerve, hook.....77
 NEWS, hook.....90
 nylon cap, mallet.....100
- O**
 O'BRIEN, scissors28
 OBWEGESER, osteotome131
 OBWEGESER, retractor...146, 147, 148
 OBWEGESER, elevator149
 OCHSNER, dressing forceps45
 O'CONNOR, retractor.....86
 OEHLER, tissue forceps.....37
 OLSEN-HEGAR, needle holder.....93
 osteotome, COTTLE.....129
 osteotome, MINI-LAMBOTTE.....132
 osteotome,
 NEIVERT-ANDERSON.....130
 osteotome, OBWEGESER131
 osteotome, RUBIN.....129
 osteotome, SILVER130
 osteotome, TESSIER151
- P**
 PARKES, nasal rasp.....134
 PARTSCH, mallet100
 PECK-JOSEPH, scissors31
 PEET, nasal rasp.....134
 pelvimeter, COLLIER.....4
 PENNINGTON, elevator.....103
 PIERCE, elevator103
 PITANGUY, facelift marker3
 plastic surgery, endoscope153
 plastic surgery,
 endoscope shaft153, 154, 155
 POTTS-SMITH, dressing forceps...36
 POTTS-SMITH, tissue forceps36
 probe, SINUS103
 PROVIDENCE-HOSPITAL,
 forceps.....61
- Q**
 QUISLING, mallet100
- R**
 RAGNELL, retractor.....65
 RAMUS, retractor148
 raspatory, FOMON.....101
 raspatory, JOSEPH.....101
 raspatory, TESSIER.....150
 REDA, retractor72
 REDA, nasal specula.....112
 REDA, knife.....125
 retractor, ALM75
 retractor, ANDERSON79
 retractor, AUFRICHT87
 retractor, BARSKY.....71
 retractor, BIGGS84
 retractor, BREAST79
 retractor, CONVERSE87
 retractor, CONVERSE89
 retractor, CORONAL.....79
 retractor, COTTLE87, 88, 89
 retractor, COTTLE-NEIVERT88
 retractor, CRILE.....65
 retractor, DEEVER67
 retractor, DESMARRES.....73
 retractor, FARABEUF65
 retractor, FERRIERA78
 retractor, FINSEN75
 retractor, FOMON88
 retractor, FREEMAN.....68, 79, 81
 retractor, FREER88
 retractor, GILLIES.....89
 retractor, GORNEY.....81
 retractor, GRAEFE.....69
 retractor, GUTHRIE69
 retractor, HOLZHEIMER.....75
 retractor, HUMBY71
 retractor, JANSEN75
 retractor, JOSEPH70
 retractor, KASDAN.....73
 retractor, KILNER88
 retractor, KLAPP72
 retractor, KLEINERT-KUTZ70
 retractor, KNAPP86
 retractor, LAHEY.....70
 retractor, LANGE89
 retractor, MALINIAC87
 retractor, MASING-NEIVERT87
 retractor, MEYERDING.....74
 retractor, MILLER86
 retractor, OBWEGESER...146, 147, 148
 retractor, O'CONNOR.....86
 retractor, RAGNELL.....65
 retractor, RAMUS148
 retractor, REDA72
 retractor, RIBBON.....66
 retractor, ROLLET86
 retractor, ROUX65
 retractor, SPINA-NASALIS148
 retractor, STRANDELL-STILLE.....74
 retractor, TEBBETS78, 83
 retractor, TYRELL.....69
 retractor, VOLKMANN73
 retractor, WEITLANER76
 retractor, WIENER.....86
 retractor, YANKOSKIE79
 REYNOLDS, scissors.....19
 RIBBON, retractor66
 ROCHESTER-OCHSNER, forceps63
 ROCHESTER-PEAN, forceps63
 ROLLET, retractor86
 rongeur, BEYER.....98
 rongeur, BÖHLER.....98
 rongeur, FRIEDMANN98
 rongeur, FRIEDMANN MINI98
 ROUX, retractor.....65
 RUBIN, septum forceps.....122
 RUBIN, osteotome.....129
 ruler, metal.....2
 RUSSEL-DAVIS , tongue
 depressor.....145
 RUSSIAN PATTERN, tissue
 forceps.....42
 RYDER, needle holder93
- S**
 SANVENERO, scissors18
 scalpel, handles.....7, 8, 9, 10, 12
 scalpel, blades11
 scalpel blade remover,11
 SCHINK, dermatome.....5
 SCHMEDEN, nasal cutting
 forceps.....121
 scissors, BEUSE31
 scissors, BONN20
 scissors, CHADWICK26
 scissors,
 CONVERSE/WILMER/WALTER ...22
 scissors, COTTLE22, 27
 scissors, COTTLE-MASING27
 scissors, FOMON27
 scissors, GOLDMAN-FOX.....29
 scissors, GORNEY30
 scissors, GORNEY-FREEMAN.....30
 scissors, GRADLE.....23
 scissors, GRAEFE22

- scissors, GREENBERG-PAR32
 scissors, HEYMAN27
 scissors, IRIS.....20
 scissors, JOSEPH18
 scissors, KAYE31, 32
 scissors, KELLY.....19
 scissors, KILNER.....19
 scissors, KNAPP21
 scissors, LA GRANGE.....26
 scissors, LEXER.....15
 scissors, LEXER-BABY15
 scissors, LITTAUER28
 scissors, LITTLER22
 scissors, MAYO13
 scissors, MAYO-STILLE14
 scissors, MC INDOE.....29
 scissors, METZENBAUM16, 17
 scissors, METZENBAUM-FINO.....17
 scissors, micro33, 34, 35
 scissors, O'BRIEN28
 scissors, PECK-JOSEPH31
 scissors, REYNOLDS.....19
 scissors, SANVENERO18
 scissors, SPENCER28
 scissors, STEVENS24
 scissors, STRABISMUS24
 scissors, WAGNER.....25
 scissors, WILMER/CONVERSE22
 SEMKEN, dressing forceps43
 SEMKEN, tissue forceps43
 septum forceps, BRUENINGS119
 septum forceps, GRAIG.....119
 septum forceps, LUC119
 septum forceps,
 MIDDLETON-JANSEN123
 septum forceps, RUBIN.....122
 septum straightening forceps,
 ASCH.....140
 septum straightening forceps,
 WALSHAM.....140
 SILVER, dermatome6
 SILVER, osteotome130
 SILVERSTEIN, dissector83
 SINGLEY, dressing forceps45
 SINUS, probe103
 skin plate for dermatomes5
 spare blades for dermatomes5, 6
 spatula, breast80
 Spatula electrode, monopolar158
 SPENCER, scissors28
 SPINA-NASALIS, retractor148
 splinter, forceps46
 STEVENS, scissors24
 STILLE, dressing forceps36
 STILLE, tissue forceps37
 STILLE-BARRAYA, tissue forceps.....45
 STRABISMUS, scissors24
 STRANDELL-STILLE, retractor.....74
 suction tube, BARON107
 suction tube, ADSON.....107
 suction tube,
 FRAZIER/FERGUSSON108
 suction tube, GUILLEN.....109
 suture forceps, CASTROVIEJO55
 suture forceps, MOD. BONN54
 suture forceps, MOD. TUEBINGEN....54
T
 TAKAHASHI, nasal cutting forceps...121
 TAYLOR, dressing forceps44
 TAYLOR, tissue forceps.....44
 TEBBETS, retractor78, 83
 TESSIER, raspatory150
 TESSIER, osteotome151
 TIECK-HALLE, nasal specula.....112
 tissue, forceps36, 37
 tissue forceps, ADSON38, 39
 tissue forceps, ADSON-BROWN40
 tissue forceps,
 BEASELEY BABCOCK39
 tissue forceps, BONNEY45
 tissue forceps, BROWN.....41
 tissue forceps, COLLIN-DUVAL.....42
 tissue forceps, CUSHING.....41
 tissue forceps, DURANTE45
 tissue forceps, DUVAL42
 tissue forceps, FERRIS-SMITH.....42
 tissue forceps, GERALD.....44
 tissue forceps, GILLIES.....43
 tissue forceps, GRAEFE.....41
 tissue forceps, LERCHE41
 tissue forceps, McINDOE42
 tissue forceps, OEHLER.....37
 tissue forceps, POTTS-SMITH36
 tissue forceps,
 RUSSIAN PATTERN42
 tissue forceps, SEMKEN43
 tissue forceps, STILLE37
 tissue forceps, STILLE-BARRAYA.....45
 tissue forceps, TAYLOR.....44
 tissue forceps, USA37
 tissue forceps, WAUGH.....41
 tongue depressor, ANDREW141
 tongue depressor, JENNINGS.....141
 tongue depressor,
 RUSSEL-DAVIS145
 tongue depressor, WIEDER141
 TROELTSCH, ear forceps57
 TYRELL, retractor.....69
U
 USA, dressing forceps36
 USA, tissue forceps37
V
 VOLKMANN, retractor73
W
 WAGNER, scissors.....25
 WALSHAM, septum
 straightening forceps140
 WALTER/CONVERSE/WILMER,
 scissors.....22
 WATSON, dermatome6
 WAUGH, tissue forceps.....41
 WEBSTER, needle holder91
 WEIL-BLAKESLEY, nasal
 cutting forceps120
 WEITLANER, retractor76
 WEST, gouge.....132
 WEST, chisel132
 WESTMACOTT, nasal forceps117
 WILDE (TROELTSCH), ear forceps ..57
 WIEDER, tongue depressor141
 WIENER, retractor.....86
 WIENER, nasal rasp.....134
 WILLIGER, elevator.....101
 WILMER/CONVERSE/WALTER,
 scissors.....22
 wire brush, nasal rasp138
 wire twisting forceps, BERRY97
 wire twisting forceps,
 MAYO-HABERISSER97
Y
 YANKOSKIE, retractor.....79

Indice Español

HADEO
INSTRUMENTE GERMANY

A	BÖHLER pinza gubia.....98, 99	CRILE-WOOD porta aguja92
abre-boca DAVIS-BOYLE.....142	BOIES elevador.....102	CRIONIN instrumento
abre-boca DAVIS-MEYER.....144	BONN Mod. pinza para sutura.....54	para labios y fisura palatina.....106
abre-boca DINGMANN.....143	BONN tijera fina.....20	cuchillo nasal CONVERSE.....125
abre-boca JENNINGS.....141	BONNEY pinza de diseccion.....45	cuchillo nasal COTTLE.....125
abre-boca KILNER-DOUGHTY.....143	BREAST separador.....79	cuchillo nasal FREER.....124
abre-boca McIVOR.....144	BROWN pinza de diseccion.....41	cuchillo nasal JOSEPH.....124, 125
ADSON gancho para duramadre...85	BRUENINGS pinza para el	cuchillo nasal REDA.....125
ADSON	tabique nasal.....119	cuchillo para capsula FOERSTER...127
micro pinza de diseccion.....38, 39	C	cuchillo para el tabique nasal
ADSON pinza de diseccion.....38, 39	CAPLAN tijera para cartilago.....122	BALLENGER.....126
ADSON pinza hemostatica.....64	CASTROVIEJO compas.....4	CUSHING gancho para nervios.....85
ADSON tubo de aspiracion.....107	CASTROVIEJO micro porta aguja.....96	CUSHING pinza de diseccion.....41
ADSON-BROWN	CASTROVIEJO pinza para sutura.....55	CUSHING-TAYLOR pinza de
pinza de diseccion.....40	cepillo de alambre.....138	diseccion.....44
ADSON-DeBAKEY	CHADWICK tijera fina.....26	D
pinza de diseccion.....38	cincel COTTLE.....129	D'ASSUMPACO instrumento
AGRIS-DINGMAN	cincel SILVER.....130	para marcar.....3
separador mamario.....82	COLLER-CRILE pinza hemostatica...61	DAVIS-BOYLE abre-boca.....142
ALM separador.....75	COLLIER pelvimetro.....4	DAVIS-MEYER abre-boca.....144
ANDERSON separador.....79	COLLIN-DUVAL pinza de diseccion..42	DEAVER separador.....67
ANDREW baja-lengua.....141	compas CASTROVIEJO.....4	DeBAKEY pinza atraumatica.....51
ASCH pinza para enderezar	CONVERSE cuchillo nasal.....125	DeBAKEY porta aguja.....92
el tabique nasal.....140	CONVERSE separador.....89	DERF porta aguja.....91
AUFRIEHT escofina nasal.....135	CONVERSE separador nasal.....87	dermatomo HUMBY.....6
AUFRIEHT separador nasal.....87	CONVERSE/WILMER/WALTER	dermatomo SCHINK.....5
B	tijera fina.....22	dermatomo SILVER.....6
BABY OLSEN-HEGAR porta aguja....93	CORONAL separador.....79	dermatomo WATSON.....6
baja-lengua ANDREW.....141	COTTLE cincel.....129	DESMARRES pinza para chalazion..55
baja-lengua McIVOR.....144	COTTLE cuchillo nasal.....125	DESMARRES separador.....73
baja-lengua RUSSEL-DAVIS.....145	COTTLE elevador para tabique...104	DINGMAN elevador.....150
baja-lengua WIEDER.....141	COTTLE escofina nasal.....135	DINGMAN escofina nasal.....138
BALLENGER cuchillo para el	COTTLE especulo nasal.....115, 116	DINGMAN legra.....150
tabique nasal.....126	COTTLE JOSEPH elevador.....103	DINGMANN abre-boca.....143
BALLENGER elevador para	COTTLE legra.....104	disector GORNEY.....102
tabique.....104	COTTLE macha cadera.....133	disector LANGENBECK.....77
BARON tubo de aspiracion.....107	COTTLE martillo.....100	disector LANGENBECK-COTTLE.....77
BARRAQUER micro porta aguja....95	COTTLE osteotomo.....129	disector MINI-LANGENBECK.....77
BARRAQUER pinza depilatoria.....55	COTTLE pinza para columela.....57	DURANTE pinza de diseccion.....45
BARSKY separador.....71	COTTLE pinza para fijacion.....57	DUVAL pinza de diseccion.....42
BAUMGARTNER porta aguja.....92	COTTLE separador.....89	
BEASELEY BABCOCK pinza de	COTTLE separador nasal.....87, 88	
diseccion.....39	COTTLE tijera fina.....22	
BERKE pinza muscular.....55	COTTLE tijera nasal.....27	
BERRY pinza para torcer hilos.....97	COTTLE-KAZANJIAN pinza gubia....99	
BEUSE Face Lift tijera.....31	COTTLE-MASING tijera nasal.....27	
BEYER pinza gubia.....98	COTTLE-NEIVERT separador nasal..88	
BIGGS separador.....84	CRILE gancho para nervios.....85	
BISHOP-HARMAN pinza para iris.....53	CRILE pinza hemostatica.....62	
BLAIR instrumento para labios y	CRILE separador.....65	
fisura palatina.....106	CRILE-RANKIN pinza hemostatica....62	

E			
elevador BOIES.....	102	FERRIS-SMITH pinza de	
elevador COTTLE JOSEPH.....	103	diseccion.....	42
elevador DINGMAN.....	150	FINSEN separador.....	75
elevador FREER.....	102, 128	FOERSTER cuchillo para capsula.....	127
elevador HOWARTH.....	103	FOMON escofina nasal.....	136, 137
elevador JOSEPH.....	102, 103	FOMON legra.....	101
elevador KILLIAN.....	103, 104	FOMON separador nasal.....	88
elevador MASING.....	102	FOMON tijera nasal.....	27
elevador McKENTY.....	102, 103	FRAZIER separador.....	70
elevador para tabique		FRAZIER/FERGUSSON tubo	
BALLENGER.....	104	de aspiracion.....	108
elevador para tabique COTTLE.....	104	FREEMAN Face separador.....	81
elevador para tabique		FREEMAN marcador para aréola.....	4
HAJEK-BALLENGER.....	104	FREEMAN separador.....	68
elevador PENNINGTON.....	103	FREEMAN separador.....	79
elevador PIERCE.....	103	FREER cuchillo nasal.....	124
elevador SINUS.....	103	FREER elevador.....	102, 128
escofina nasal AUFRICHT.....	135	FREER gubia.....	132
escofina nasal COTTLE.....	135	FREER separador nasal.....	88
escofina nasal DINGMAN.....	138	FRIEDMANN MICRO pinza gubia.....	98
escofina nasal FOMON.....	136, 137	FRIEDMANN MINI pinza gubia.....	98
escofina nasal GLABELLA.....	134	FRIEDMANN pinza gubia.....	98
escofina nasal JOSEPH.....	134, 135		
escofina nasal LEWIS.....	135	G	
escofina nasal MALTZ.....	134, 135	gancho para duramadre ADSON.....	85
escofina nasal PARKES.....	134	gancho para nervios.....	77, 85
escofina nasal PEET.....	134	gancho para nervios CRILE.....	85
escofina nasal WIENER.....	134	gancho para nervios CUSHING.....	85
espatula.....	80	gancho para traqueotomia	
espatula abdominal e intestinal		JACKSON.....	90
RIBBON.....	66	gancho para traqueotomia NEWS.....	90
especulo nasal COTTLE.....	115, 116	GERALD pinza de diseccion.....	43, 44
especulo nasal HARTMANN.....	111	GERZOG martillo.....	100
especulo nasal		GILLIES pinza de diseccion.....	43
HARTMANN-HALLE.....	110	GILLIES porta aguja.....	94
especulo nasal KILLIAN.....	113, 114	GILLIES separador.....	89
especulo nasal Mod. WIEN.....	112	GLABELLA escofina nasal.....	134
especulo nasal REDA.....	112	GOLDMAN-FOX tijera para encias.....	29
especulo nasal TIECK-HALLE.....	112	goniometro MOELTGEN.....	2
		goniometro para dedos.....	2
F		GORNEY disector.....	102
Face Lift tijera BEUSE.....	31	GORNEY Face Lift tijera.....	30
Face Lift tijera GORNEY.....	30	GORNEY separador.....	81
Face Lift tijera		GORNEY-FREEMAN	
GORNEY-FREEMAN.....	30	Face Lift tijera.....	30
Face Lift tijera KAYE.....	31	GRADLE tijera fina.....	23
Face Lift tijera PECK-JOSEPH.....	31	GRAEFE pinza de diseccion.....	41
FARABEUF separador.....	65	GRAEFE pinza para iris.....	52
FERGUSSON/FRAZIER tubo de		GRAEFE separador.....	69
aspiracion.....	108	GRAEFE tijera fina.....	22
FERRIERA separador.....	78	GRAIG pinza para el tabique	
		nasal.....	119
		GREEN pinza para fijacion.....	56
		GREENBERG-PAR tijera para	
		blefaroplastia.....	32
		gubia FREER.....	132
		gubia HAJEK.....	132
		gubia KILLIAN.....	130
		gubia KILLIAN-CLAUS.....	132
		gubia WEST.....	132
		GUILLEN tubo de aspiracion.....	109
		GUTHRIE separador.....	69
		H	
		HAJEK gubia.....	132
		HAJEK-BALLENGER elevador	
		para tabique.....	104
		HALSEY porta aguja.....	91
		HALSTEAD-MOSQUITO micro	
		pinza hemostatica.....	60
		HALSTEAD-MOSQUITO pinza	
		hemostatica.....	60
		HARTMANN espejito nasal.....	111
		HARTMANN pinza hemostatica.....	59
		HARTMANN pinza para polipos.....	117
		HARTMANN-HALLE espejito	
		nasal.....	110
		HEYMAN tijera nasal.....	27
		HEYMANN-KNIGHT pinza para	
		polipos.....	118
		hoja de repuesto para	
		dermatomo.....	5, 6
		hojas de bisturie.....	11
		HOLZHEIMER separador.....	75
		HOWARTH elevador.....	103
		HUMBY dermatomo.....	6
		HUMBY separador.....	71
		I	
		instrumento para labios y fisura	
		palatina BLAIR.....	106
		instrumento para labios y fisura	
		palatina CRIONIN.....	106
		instrumento para marcar	
		D' ASSUMPACO.....	3
		instrumento para marcar	
		LOCKWOOD.....	3
		instrumentos para endoscopia.....	152-158
		instrumentos para labios y	
		fisura palatina.....	105, 106
		IRIS tijera fina.....	20

Indice Español

HADEO
INSTRUMENTE GERMANY

J			
JACKSON gancho para traqueotomía.....	90	legra OBWEGESER.....	149
JAEGER placa para parado.....	58	legra WILLIGER.....	101
JANSEN separador.....	75	LERCHE pinza de disección.....	41
JANSEN-GRUENWALD pinza auricular.....	57	LERICHE pinza hemostática.....	63
JENNINGS abre-boca.....	141	LEWIS escofina nasal.....	135
JOSEPH cuchillo nasal.....	124, 125	LEXER tijera de disección.....	15
JOSEPH elevador.....	102, 103	LEXER-BABY tijera de disección.....	15
JOSEPH escofina nasal.....	134, 135	LITTAUER tijera para hilos.....	28
JOSEPH legra.....	101	LITTLER tijera fina.....	22
JOSEPH separador.....	70	LOCKWOOD instrumento para marcar.....	3
JOSEPH sierra nasal.....	138, 139	LUBET-BARBON pinza para taponamiento.....	117
JOSEPH tijera de disección.....	18	LUC pinza para el tabique nasal.....	119
JOST macha cadera.....	133	LUCAE pinza auricular.....	57
K		M	
KASDAN separador.....	73	MacCOLLUM-DINGMAN separador mamario.....	83
KAYE Face Lift tijera.....	31	macha cadera COTTLE.....	133
KAYE tijera para blefaroplastia.....	32	macha cadera JOST.....	133
KELLY pinza hemostática.....	61	MALINIAC separador nasal.....	87
KELLY tijera de disección.....	19	MALTZ escofina nasal.....	134, 135
KELLY-RANKIN pinza hemostática.....	61	mango de bisturí.....	7-10, 12
KILLIAN elevador.....	103, 104	marcador para areola FREEMAN.....	4
KILLIAN especulo nasal.....	113, 114	marcador para areola McKISSOCK.....	4
KILLIAN gubia.....	130	marcador para facelift PITANGUY.....	3
KILLIAN-CLAUS gubia.....	132	martillo COTTLE.....	100
KILLNER separador nasal.....	88	martillo GERZOG.....	100
KILNER RAGNELL tijera de disección.....	19	martillo MEAD.....	100
KILNER-DOUGHTY abre-boca.....	143	martillo PARTSCH.....	100
KLAPP separador.....	72	martillo QUISLING.....	100
KLEINERT-LUTZ separador.....	70	martillos.....	100
KNAPP separador.....	86	MARTINEZ-KILNER separador.....	89
KNAPP tijera fina.....	21	MASING elevador.....	102
KNIGHT pinza para el tabique nasal.....	118	MASING-NEIVERT separador nasal.....	87
L		MAYO tijera de disección.....	13
LA GRANGE tijera fina.....	26	MAYO-HABERISSER pinza para torcer hilos.....	97
LAHEY separador.....	70	MAYO-HEGAR porta aguja.....	92
LAMBOTTE-MINI osteotomo.....	132	MAYO-STILLE tijera de disección.....	14
LANGE separador.....	89	MC INDOE pinza gubia.....	99
LANGENBECK disector.....	77	MC INDOE tijera para cartilago.....	29
LANGENBECK legra.....	101	McINDOE pinza de disección.....	42
LANGENBECK-COTTLE disector.....	77	McIVOR abre-boca.....	144
legra COTTLE.....	104	McIVOR baja-lengua.....	144
legra DINGMAN.....	150	McKENTY elevador.....	102, 103
legra FOMON.....	101	McKISSOCK marcador para areola.....	4
legra JOSEPH.....	101	MEAD martillo.....	100
legra LANGENBECK.....	101	METZENBAUM tijera de disección.....	16, 17
		METZENBAUM-FINO tijera de disección.....	17
		MEYERDING separador.....	74
		MICRO FRIEDMANN pinza gubia.....	98
		micro pinzas.....	47-49
		micro porta aguja BARRAQUER.....	95
		micro porta aguja CASTROVIEJO.....	96
		micro tijeras.....	33-35
		MICROVASCULAR porta aguja.....	93
		MIDDLETON-JANSEN pinza para el tabique nasal.....	123
		MILLER separador.....	86
		MINI-LAMBOTTE osteotomo.....	132
		MINI-LANGENBECK disector.....	77
		Mod. BONN pinza para sutura.....	54
		Mod. RUSO pinza de disección.....	42
		Mod. TUEBINGEN pinza para sutura.....	54
		Mod. WIEN especulo nasal.....	112
		MOELTGEN goniometro.....	2
		MYLES pinza cortante nasal.....	121
		N	
		NEIVERT-ANDERSON osteotomo.....	130
		NEWS gancho para traqueotomía.....	90
		O	
		O'BRIEN tijera para hilos.....	28
		O'CONNOR separador.....	86
		OBWEGESER legra.....	149
		OBWEGESER osteotomo.....	131
		OBWEGESER separador para cirugía de boca-mandibula-fiscal.....	146-148
		OCHSNER pinza de disección.....	45
		OEHLER pinza de disección.....	37
		OLSEN-HEGAR BABY porta aguja.....	93
		OLSEN-HEGAR porta aguja.....	93
		osteotomo COTTLE.....	129
		osteotomo MINI-LAMBOTTE.....	132
		osteotomo NEIVERT-ANDERSON.....	130
		osteotomo OBWEGESER.....	131
		osteotomo RUBIN.....	129
		osteotomo TESSIER.....	151
		osteotomo WEST.....	132

P			
PARKES escofina nasal	134	pinza de diseccion	
PARTSCH martillo	100	STILLE-BARRAYA	45
PECK-JOSEPH Face Lift tijera.....	31	pinza de diseccion TAYLOR	44
PEET escofina nasal	134	pinza de diseccion	
pelvimetro COLLIER.....	4	TAYLOR-CUSHING	44
PENNINGTON elevador	103	pinza de diseccion USA.....	36, 37
PIERCE elevador.....	103	pinza de diseccion WAUGH	41
pinza atraumatica DeBAKEY	51	pinza depilatoria BARRAQUER.....	55
pinza auricular		pinza gubia BEYER	98
JANSEN-GRUENWALD	57	pinza gubia BÖHLER.....	98, 99
pinza auricular LUCAE	57	pinza gubia COTTLE-KAZANJIAN	99
pinza auricular TROELTSCH	57	pinza gubia FRIEDMANN	98
pinza auricular WILDE		pinza gubia FRIEDMANN MINI	98
(TROELTSCH).....	57	pinza gubia MC INDOE	99
pinza cortante nasal MYLES	121	pinza gubia MICRO FRIEDMANN.....	98
pinza cortante nasal		pinza hemostatica ADSON	64
SCHMEDEN	121	pinza hemostatica COLLER-CRILE.....	61
pinza cortante nasal		pinza hemostatica CRILE	62
TAKAHASHI.....	121	pinza hemostatica CRILE-RANKIN	62
pinza cortante nasal		pinza hemostatica	
WEIL-BLAKESLEY	120	HALSTEAD-MOSQUITO	60
pinza de diseccion ADSON.....	38, 39	pinza hemostatica	
pinza de diseccion		HALSTEAD-MOSQUITO micro	60
ADSON micro	38, 39	pinza hemostatica HARTMANN	59
pinza de diseccion		pinza hemostatica KELLY	61
ADSON-BROWN	40	pinza hemostatica KELLY-RANKIN	61
pinza de diseccion		pinza hemostatica LERICHE	63
ADSON-DeBAKEY	38	pinza hemostatica	
pinza de diseccion		PROVIDENCE-HOSPITAL	61
BEASELEY BABCOCK	39	pinza hemostatica	
pinza de diseccion BONNEY	45	ROCHESTER-OCHSNER	63
pinza de diseccion BROWN	41	pinza hemostatica	
pinza de diseccion COLLIN-DUVAL	42	ROCHESTER-PEAN	63
pinza de diseccion CUSHING.....	41	pinza muscular BERKE	55
pinza de diseccion		pinza para chalazion	
CUSHING-TAYLOR	44	DESMARRES.....	55
pinza de diseccion DURANTE.....	45	pinza para columela COTTLE	57
pinza de diseccion DUVAL	42	pinza para el tabique nasal	
pinza de diseccion FERRIS-SMITH.....	42	BRUENINGS.....	119
pinza de diseccion GERALD	43, 44	pinza para el tabique nasal	
pinza de diseccion GILLIES.....	43	GRAIG	119
pinza de diseccion GRAEFE	41	pinza para el tabique nasal	
pinza de diseccion LERCHE.....	41	KNIGHT	118
pinza de diseccion McINDOE	42	pinza para el tabique nasal LUC.....	119
pinza de diseccion Mod. RUSO.....	42	pinza para el tabique nasal	
pinza de diseccion OCHSNER	45	MIDDLETON-JANSEN	123
pinza de diseccion OEHLER	37	pinza para el tabique nasal RUBIN.....	122
pinza de diseccion POTTS-SMITH.....	36	pinza para enderezar el tabique	
pinza de diseccion SEMKEN.....	43	nasal ASCH	140
pinza de diseccion SINGLEY.....	45	pinza para enderezar el tabique	
pinza de diseccion STILLE	36, 37	nasal WALSHAM	140
		pinza para fijacion COTTLE.....	57
		pinza para fijacion GREEN.....	56
		pinza para iris BISHOP-HARMAN	53
		pinza para iris GRAEFE.....	52
		pinza para polipos HARTMANN	117
		pinza para polipos	
		HEYMANN-KNIGHT	118
		pinza para sutura CASTROVIEJO.....	55
		pinza para sutura Mod. BONN.....	54
		pinza para sutura	
		Mod. TUEBINGEN	54
		pinza para taponamiento	
		LUBET-BARBON	117
		pinza para taponamiento	
		WESTMACOTT	117
		pinza para torcer hilos BERRY	97
		pinza para torcer hilos	
		MAYO-HABERISSER	97
		pinzas atraumaticas con TC	50
		pinzas de diseccion sin y con	
		dientes.....	36-45
		pinzas para espinas.....	46
		PITANGUY marcador para facelift....	3
		placa para extender la piel	5
		placa para parado JAEGER	58
		porta aguja BABY OLSEN-HEGAR	93
		porta aguja BAUMGARTNER	92
		porta aguja CRILE-WOOD	92
		porta aguja DeBAKEY	92
		porta aguja DERF	91
		porta aguja GILLIES	94
		porta aguja HALSEY.....	91
		porta aguja MAYO-HEGAR	92
		porta aguja MICROVASCULAR.....	93
		porta aguja OLSEN-HEGAR.....	93
		porta aguja RYDER	93
		porta aguja WEBSTER.....	91
		POTTS-SMITH pinza de diseccion.....	36
		PROVIDENCE-HOSPITAL	
		pinza hemostatica.....	61
		Q	
		QUISLING martillo.....	100

Indice Español

HADEO
INSTRUMENTE GERMANY

R			
RAGNELL separador	65	separador GRAEFE	69
RAMUS separador para cirugía de boca-mandibula-fiscal.....	148	separador GUTHRIE	69
REDA cuchillo nasal	125	separador HOLZHEIMER	75
REDA espejito nasal	112	separador HUMBY.....	71
REDA separador	72	separador JANSEN	75
regla.....	2	separador JOSEPH	70
REYNOLDS JAMESON tijera de disección	19	separador KASDAN.....	73
RIBBON espátula abdominal e intestinal	66	separador KLAPP.....	72
ROCHESTER-OCHSNER pinza hemostática	63	separador KLEINERT-LUTZ	70
ROCHESTER-PEAN pinza hemostática	63	separador KNAPP	86
ROLLET separador.....	86	separador LAHEY.....	70
ROUX mini separador.....	65	separador LANGE	89
RUBIN osteotomo.....	129	separador mamario	
RUBIN pinza para el tabique nasal	122	AGRIS-DINGMAN	82
RUSO Mod. pinza de disección	42	separador mamario	
RUSSEL-DAVIS baja-lengua.....	145	MacCOLLUM-DINGMAN.....	83
RYDER porta aguja	93	separador mamario SILVERSTEIN	83
		separador mamario TEBBETTS	83
S		separador MARTINEZ-KILNER	89
SANVENERO tijera de disección	18	separador MEYERDING.....	74
SCHINK dermatomo	5	separador MILLER.....	86
SCHMEDEN pinza cortante nasal	121	separador nasal AUFRICHT	87
SEMKEN pinza de disección	43	separador nasal CONVERSE.....	87
separador ALM	75	separador nasal COTTLE.....	87, 88
separador ANDERSON	79	separador nasal	
separador BARSKY	71	COTTLE-NEIVERT	88
separador BIGGS	84	separador nasal FOMON.....	88
separador BREAST	79	separador nasal FREER.....	88
separador CONVERSE	89	separador nasal KILLNER.....	88
separador CORONAL.....	79	separador nasal MALINIAC.....	87
separador COTTLE	89	separador nasal	
separador CRILE.....	65	MASING-NEIVERT.....	87
separador de movilización		separador O'CONNOR.....	86
TESSIER	150	separador para cirugía de boca-mandibula-fiscal	
separador DEAYER	67	OBWEGESER.....	146-148
separador DESMARRES.....	73	separador para cirugía de boca-mandibula-fiscal RAMUS.....	148
separador FARABEUF.....	65	separador para cirugía de boca-mandibula-fiscal	
separador FERRIERA	78	SPINA-NASALIS.....	148
separador FINSSEN	75	separador RAGNELL.....	65
separador FRAZIER	70	separador REDA.....	72
separador FREEMAN	68	separador ROLLET.....	86
separador FREEMAN	79	separador ROUX mini.....	65
separador FREEMAN Face.....	81	separador STRANDELL-STILLE	74
separador GILLIES.....	89	separador TEBBETTS	78
separador GORNEY.....	81	separador TYRELL.....	69
		separador VOLKMANN	73
		separador WEITLANER.....	76
		separador WIENER	86
		separador YANKOSKIE	79
		sierra nasal JOSEPH.....	138, 139
		SILVER cincel.....	130
		SILVER dermatomo	6
		SILVERSTEIN separador mamario	83
		SINGLEY pinza de disección	45
		SINUS elevador.....	103
		SPENCER tijera para hilos.....	28
		SPINA-NASALIS separador para cirugía de boca-mandibula-fiscal	148
		STEVENS tijera fina	24
		STILLE pinza de disección	36, 37
		STILLE-BARRAYA pinza de disección	45
		STRABISMUS tijera fina.....	24
		STRANDELL-STILLE separador	74
		T	
		TAKAHASHI pinza cortante nasal	121
		TAYLOR pinza de disección	44
		TAYLOR-CUSHING pinza de disección	44
		TEBBETTS separador.....	78
		TEBBETTS separador mamario.....	83
		TESSIER osteotomo.....	151
		TESSIER separador de movilización	150
		TIECK-HALLE espejito nasal	112
		tijera de disección JOSEPH.....	18
		tijera de disección KELLY	19
		tijera de disección	
		KILNER RAGNELL.....	19
		tijera de disección LEXER.....	15
		tijera de disección LEXER-BABY	15
		tijera de disección MAYO.....	13
		tijera de disección MAYO-STILLE	14
		tijera de disección	
		METZENBAUM.....	16, 17
		tijera de disección	
		METZENBAUM-FINO.....	17
		tijera de disección	
		REYNOLDS JAMESON.....	19
		tijera de disección SANVENERO	18
		tijera fina BONN.....	20
		tijera fina CHADWICK.....	26
		tijera fina	
		CONVERSE/WILMER/WALTER.....	22
		tijera fina COTTLE.....	22
		tijera fina GRADLE	23
		tijera fina GRAEFE	22
		tijera fina IRIS	20
		tijera fina KNAPP	21
		tijera fina LA GRANGE	26

tijera fina LITTLER.....	22	W	
tijera fina para oftalmologia.....	23	WAGNER tijera fina	25
tijera fina STEVENS	24	WALSHAM pinza para enderezar	
tijera fina STRABISMUS.....	24	el tabique nasal	140
tijera fina WAGNER	25	WALTER/CONVERSE/WILMER	
tijera fina WILMER/CONVERSE.....	22	tijera fina	22
tijera nasal COTTLE	27	WATSON dermatomo	6
tijera nasal COTTLE-MASING.....	27	WAUGH pinza de diseccion	41
tijera nasal FOMON	27	WEBSTER porta aguja.....	91
tijera nasal HEYMAN.....	27	WEIL-BLAKESLEY pinza cortante	
tijera para blefaroplastia		nasal	120
GREENBERG-PAR	32	WEITLANER separador.....	76
tijera para blefaroplastia KAYE.....	32	WEST gubia.....	132
tijera para cartilago CAPLAN.....	122	WEST osteotomo.....	132
tijera para cartilago MC INDOE.....	29	WESTMACOTT pinza para	
tijera para encias GOLDMAN-FOX.....	29	taponamiento	117
tijera para hilos LITTAUER	28	WIEDER baja-lengua.....	141
tijera para hilos O'BRIEN	28	WIEN Mod. espejulo nasal	112
tijera para hilos SPENCER	28	WIENER escofina nasal	134
TROELTSCH pinza auricular.....	57	WIENER separador	86
tubo de aspiracion ADSON.....	107	WILDE (TROELTSCH) pinza	
tubo de aspiracion BARON.....	107	auricular.....	57
tubo de aspiracion		WILLIGER legra.....	101
FRAZIER/FERGUSSON.....	108	WILMER/CONVERSE/WALTER	
tubo de aspiracion GUILLEN	109	tijera fina	22
TUEBINGEN Mod. pinza para		Y	
sutura.....	54	YANKOSKIE separador	79
TYRELL separador	69		
U			
USA pinza de diseccion.....	36, 37		
V			
VOLKMANN separador	73		

Indice Italiano

HADEO
INSTRUMENTE GERMANY

A		BONNEY pinze chirurgiche45	COTTLE scalpello per plastica nasale129
Abbassalingua Andrew141	Breast divaricatore.....79	BROWN Pinze chirurgiche41	Cottle specoli nasali115
abbassalingua Davis-Boyle142	BRUENINGS pinza per il setto nasale119	Cottle specoli nasali116	Cottle Tritacartilagine133
abbassalingua Dingmann143	C	Cottle-Joseph elevatore per setto103	COTTLE-MASING forbici nasali27
abbassalingua Kilner-Doughty.....143	Camicia per chirurgia plastica.....153	Cottle-Neivert retrattore nasale88	CRILE divaricatore doppio.....65
abbassalingua Russel-Davis145	Camicia per chirurgia plastica154	CRILE pinze emostatiche62	CRILE RANKIN pinze emostatiche.....62
abbassalingua Wieder141	Camicia per chirurgia plastica155	Crile uncini per nervi.....85	CRILE WOOD portaghi92
Adson cannula di aspirazione.....107	Cannula di aspirazione107	CUSHING pinza anatomica41	CUSHING pinza chirurgica 1x241
ADSON pinza emostatica64	cannula di aspirazione Baron107	Cushing uncini per nervi85	Cushing-Taylor pinza a baionetta ...44
Adson uncini per dura-madre85	Cannula di aspirazione Guilen.....109	D	
AGRIS-DINGMAN separatori mammari.....82	Cannule di aspirazione	D'ASSUMPACO strumento per marcare3	
ALM divaricatori.....75	Frazier/Fergusson108	DAVIS BOYLE abbassalingua142	
Anderson uncini per pelle79	CAPLAN cesoia per setto nasale122	DAVIS BOYLE apribocca completo142	
ANDREW abbassalingua141	Castroviejo compasso4	Davis-Boyle Telaio solo142	
Apribocca completo Davis-Boyle.....142	Castroviejo micro portaghi96	DE BAKEY portaghi92	
apribocca Dingmann.....143	Castroviejo pinze per sutura55	DEAVER divaricatori addominali ...67	
apribocca Jennings.....141	Cesoia per setto nasale Caplan.....122	DEBAKEY micro pinza atraumatica...49	
apribocca KILNER DOUGHTY143	Chadwick forbici gengivali26	DeBakey pinze atraumatiche51	
ASCH pinza per raddrizzare il setto nasale140	Coller-Crile pinze emostatiche.....61	DeBakey pinze atraumatiche TC...50	
AUFRICHT raspa nasale135	Collier compasso4	DERF portaghi91	
Aufricht retrattori nasali.....87	COLLIN DUVAL pinza fenestrata.....42	Dermatomo Humby6	
B	coltello falcato REDA.....125	Dermatomo Schink5	
Baby OLSEN HEGAR portaghi.....93	Coltello per capsula Foerster.....127	Dermatomo Silver6	
BABY-WEBSTER portaghi91	Coltello per il setto nasale Freer124	Dermatomo Watson.....6	
BALLENGER coltello per setto.....126	Coltello per mucosa Freer124	DESMARRES divaricatori73	
Ballenger elevatore per setto.....104	coltello per setto Ballenger126	Desmarres pinze per calazio55	
BARON Cannula di aspirazione ...107	Compasso Castroviejo4	Dingman divaricatore.....150	
BARRAQUER micro portaghi95	Compasso Collier4	DINGMAN raspa nasale138	
Barraquer pinza depilatoria55	CONVERSE bisturi per rinoplastica125	DINGMANN abbassalingua143	
BARSKY uncinetto per pelle.....71	Converse divaricatore.....89	DINGMANN apribocca143	
BAUMGARTNER portaghi92	Converse retrattori nasali87	DINGMANN periostotomo doppio.....150	
Berke pinze muscolari55	CONVERSE/WILMER/WALTER forbici delicate.....22	Dischi di ricambio per martello100	
Berry Pinza torcifili97	CORONAL divaricatore79	Dissettore Gorney.....102	
BEUSE face lift forbici31	COTTLE bisturi per setto nasale125	dissettori Williger101	
BEYER pinza sgorbia98	Cottle divaricatori.....89	divaricat.dopp.coppia Farabeuf65	
Biggs divaricatore con luce fredda.....84	Cottle elevatore per setto103	Divaricatore150	
Bishop-Harmann pinze per iride53	Cottle elevatore per setto104	Divaricatore Breast79	
Bisturi per cartilagine Joseph124	Cottle forbici delicate22	Divaricatore con luce fredda Biggs84	
bisturi per rinoplastica Converse125	COTTLE forbici nasali27	Divaricatore Converse89	
bisturi per rinoplastica Cottle125	COTTLE KAZANJIAN cesoia per ossa99	Divaricatore Coronal.....79	
Bisturi per rinoplastica Joseph.....124	COTTLE martello metallico100		
BLAIR elevatore per fessure del palato106	COTTLE osteotomo129		
BOEHLER cesoie per ossa99	Cottle pinza per columella57		
BOEHLER pinza sgorbia98	Cottle retrattore nasale87		
BOIES sgorbia periostotomo102	Cottle retrattore nasale88		
BONN forcice delicata20			
BONNEY pinza anatomica45			
BONNEY pinze chirurgiche45			

Divaricatore Dingman	150	E		Forbici delicate Littler	22
Divaricatore doppio Crile	65	Elettrodi monopolari	158	Forbici delicate Wagner	25
Divaricatore doppio Ragnel	65	Elevatore Langenbeck	101	Forbici endoscopici	156
Divaricatore doppio Roux	65	elevatore per periostio Masing	102	Forbici gengivali Chadwick	26
Divaricatore Freemann	81	Elevatore per setto	104	Forbici gengivali Goldmann-Fox	29
Divaricatore Gorney	81	Elevatore per setto Cottle	103	Forbici gengivali La Grange	26
Divaricatore Kasdan	73	Elevatore per setto Cottle	104	Forbici gengivali Mc Indoe	29
Divaricatore Knapp	86	Elevatore per setto Cottle-Joseph	103	Forbici nasali Cottle	27
Divaricatore Lange	89	Elevatore per setto Freer	102	Forbici nasali Cottle-Masing	27
Divaricatore Martinez-Kilner	89	Elevatore per setto		Forbici nasali Fomon	27
Divaricatore Miller	86	Hajek-Ballenger	104	Forbici nasali Heymann	27
divaricatore Obwegeser	146	Elevatore per setto Howarth	103	Forbici per dissezione	15
divaricatore Obwegeser	147	Elevatore per setto Joseph	102	Forbici per dissezione	19
divaricatore Obwegeser	148	Elevatore per setto Killian	103	Forbici per dissezione	19
Divaricatore O'Connor	86	Elevatore per setto Killian	104	Forbici per dissezione Joseph	18
Divaricatore Ramus	148	Elevatore per setto McKenty	102	Forbici per dissezione Kilner	19
Divaricatore Rollet	86	Elevatore per setto McKenty	103	Forbici per dissezione Lexer-Baby	15
Divaricatore Spina-Nasalis	148	Elevatore per setto Pennington	103	Forbici per dissezione MAYO	13
Divaricatore Tessier	150	Elevatore per setto Pierce	103	Forbici per dissezione MAYO-Stille	14
Divaricatori	72	Elevatore per setto Sinus	103	Forbici per dissezione Metzenbaum	16
Divaricatori addominali Deaver	67	Endo dissettore Langenbeck	77	Forbici per dissezione Metzenbaum	17
Divaricatori Alm	75	Endo dissettore Langenbeck-Cottle	77	Forbici per dissezione	
Divaricatori Cottle	89	Endo dissettore Mini-Langenbeck	77	SANVENERO	18
Divaricatori Desmarres	73	F		Forbici per strabismo	24
Divaricatori Ferriera	78	Face lift forbici Beuse	31	Forbici taglia fili Littauer	28
Divaricatori Finsen	75	Face lift forbici Gorney	30	Forbici taglia fili O'Brien	28
Divaricatori Freeman	68	Face lift forbici Gorney-Freemann	30	Forbici taglia fili Spencer	28
Divaricatori Freeman	79	Face lift forbici Kaye	31	FRAZIER uncinetto acuto	70
Divaricatori Gillies	89	Face lift forbici Peck-Joseph	31	FRAZIER uncinetto smusso	70
Divaricatori Holzheimer	75	FARABEUF divaricat.dopp.coppia	65	Frazier/Fergusson cannula di	
Divaricatori Jansen	75	Ferriera divaricatori	78	aspirazione	108
Divaricatori Klapp	72	FERRIS SMITH pinze chirurgiche	42	FREEMAN divaricatore	81
Divaricatori Lahey	70	FINSEN divaricatori	75	Freeman divaricatori	68
Divaricatori Meyerding	74	FOERSTER coltello per capsula	127	FREEMAN divaricatori	79
divaricatori Strandel-Stille	74	FOMON forbici nasali	27	FREEMAN, strumento per marcare	4
Divaricatori Volkmann	73	FOMON Periostotomo	101	FREER coltello per il setto nasale	124
Divaricatori Weitlaner	76	FOMON raspa nasale doppia	136	FREER coltello per mucosa	124
Divaricatori Wiener	86	FOMON raspa nasale doppia	137	FREER elevatore per setto	102
Divaricatori Yancoskie	79	Fomon retrattori nasali	88	FREER osteotomo per setto	
DURANTE pinze anatomiche	45	forbice delicata Bonn	20	nasale	128
DUVAL pinza fenestrata	42	Forbici blefaroplastica	32	Freer retrattore nasale	88
		forbici blefaroplastica		FREER sgorbia nasale	132
		Greenberg-Par	32	FRIEDMAN MICRO pinza sgorbia	98
		Forbici delicate	24	FRIEDMAN mini pinza sgorbia	98
		Forbici delicate			
		CONVERSE/WILMER/WALTER	22		
		Forbici delicate Cottle	22		
		Forbici delicate Gradle	23		
		Forbici delicate Graefe	22		
		forbici delicate IRIS	20		
		Forbici delicate Knapp	21		

Indice Italiano

HADEO
INSTRUMENTE GERMANY

G	I	L
Ganci per tracheotomia Jackson90	Iris forbici delicate20	La Grange forbici gengivali26
Gancio per tracheotomia News90	J	LAHEY divaricatori.....70
GERALD pinza chirurgica 1x2.....43	Jackson ganci per tracheotomia.....90	Lama di ricambio per dermatomo....5
GERALD pinze anatomiche.....43	JANSEN divaricatori75	Lama di ricambio, non sterile.....6
GERALD pinze chirurgiche44	Jansen-Gruenwald pinza	Lame per bisturi.....10
GERZOG Martello metallico100	auricolare57	Lame per bisturi.....11
Gillies Divaricatori.....89	JENNINGS apribocca141	Lange divaricatore.....89
GILLIES pinze 1x2 denti.....43	JOSEPH (LEWIS) raspa nasale ...135	LANGENBECK elevatore101
GILLIES portaghi tagliente.....94	JOSEPH bisturi per cartilagine124	LANGENBECK Endo disettore.....77
Glabella raspa nasale134	JOSEPH bisturi per rinoplastica ...124	LANGENBECK-Cottle Endo
GOLDMANN-FOX forbici gengivali.....29	Joseph elevatore per setto102	dissettori77
Goniometro Moeltgen2	JOSEPH forbici per dissezione18	LERCHE pinza 5x6 denti41
Goniometro per le dita2	JOSEPH lima per ossa134	LERICHE pinze emostatiche63
GORNEY disettore102	JOSEPH Periostotomo101	LEXER baby forbici per dissezione15
Gorney divaricatore81	JOSEPH sega nasale138	LEXER forbici per dissezione15
Gorney face lift forbici.....30	JOSEPH sega nasale angolata...139	lima per ossa Joseph.....134
Gorney-Freemann face lift forbici30	JOSEPH uncino mucosa70	LITTAUER forbici taglia fili.....28
Gradle forbici delicate.....23	Jost tritacartilagine.....133	LITTLER forbici delicate22
GRAEFE forbici delicate22	K	LOCKWOOD strumento per
GRAEFE pinza morsi dentellati41	Kasdan divaricatore.....73	marcare3
Graefe pinze per iride52	KAYE face lift forbici31	LUBET-BARBON pinza per
GRAEFE uncinetto acuto69	Kaye forbici blefaroplastica.....32	medicature117
GRAEFE uncinetto smusso69	Kelly forbici per dissezione19	LUC pinza tagliente per il setto
Graig pinza per il setto nasale119	KELLY pinze emostatiche.....51	nasale119
Green pinze fissatrici56	KELLY RANKIN pinze emostatiche ...61	Lucae pinze auricolari.....57
GREENBERG-PAR forbici	KILLIAN CLAUS sgorbia132	M
bleforoplastica32	KILLIAN elevatore per setto103	MacCollum-Dingmann
Guilen cannula di aspirazione109	KILLIAN elevatore per setto104	separatori mammari.....83
GUTHRIE uncinetto doppio acuto69	Killian sgorbia130	Maliniac retrattore nasale87
GUTHRIE uncinetto doppio smusso...69	Killian specoli nasali.....113	MALTZ (COTTLE) raspa nasale135
H	Killian specoli nasali.....114	Maltz raspa nasale134
HAJEK sgorbia132	KILNER DOUGHTY	Manici per lame bisturi.....7
Hajek-Ballenger elevatore per	abbassalingua143	Manici per lame bisturi.....8
setto.....104	KILNER DOUGHTY apribocca143	Manici per lame bisturi.....10
HALSEY portaghi91	KILNER forbici per dissezione19	Manici per lame bisturi.....12
HALSTED-Mosquito micro pinze.....60	Kilner retrattore nasale88	Martelli100
HALSTED-Mosquito pinze.....60	Klapp divaricatori72	Martello intranasale Quisling100
HARTMANN pinza per polipi	KLEINERT-KUTZ uncinetto	Martello Mead.....100
nasali117	acuto per pelle70	Martello metallico Cottle100
Hartmann pinze emostatiche.....59	Knapp divaricatore.....86	Martello metallico Gerzog.....100
Hartmann specoli nasali.....111	KNAPP forbici delicate.....21	Martello metallico Partsch.....100
Hartmann-Halle specoli nasali110	KNIGHT pinza per il setto118	Martello metallico Pansch.....100
HEYMANN forbici nasali.....27		Martinez-Kilner divaricatore89
HEYMANN KNIGHT pinza nasale118		MASING elevatore per periostio...102
HOLZHEIMER divaricatori.....75		Masing-Neivert retrattore nasale ...87
HOWARTH elevatore per setto103		MAYO forbici per dissezione.....13
Humby dermatomo6		Mayo-HaberISSER pinze torcifili97
HUMBY uncinetto doppio per pelle.....71		MAYO-Hegar portaghi92
		MAYO-Stille forbici per dissezione.....14
		MC INDOE cesoia per ossa99

MC Indoe forbici gengivali29	Osteotomo Obwegeser.....131	Pinza per medicature Westmacott117
McINDOE pinza 1x2 denti42	osteotomo per setto nasale Freer.....128	Pinza per polipi nasali
MCINDOE pinza anatomica42	osteotomo Rubin129	HARTMANN117
McIVOR abbassalingua144	Osteotomo Tessier.....151	pinza per raddrizzare il setto
McIVOR apribocca completo.....144	Ottica per endoplastica.....152	nasale Asch140
McKENTY elevatore per setto102		pinza per raddrizzare il setto
McKENTY elevatore per setto103	P	nasale Walsham140
McKISSOCK, strumento per	Parkes raspa nasale134	pinza sgorbia Beyer.....98
marcare4	PARTSCH martello metallico.....100	Pinza sgorbia BOEHLER98
MEAD martello100	PECK-JOSEPH face lift forbici31	pinza sgorbia Friedmann98
METZENBAUM forbici per	Peet raspa nasale.....134	pinza sgorbia mini Friedman98
dissezione.....16	PENNINGTON Elevatore per setto...103	pinza tagliente nasale
METZENBAUM forbici per	Periostotomo doppio Dingman150	Weil-Blakesley120
dissezione.....17	Periostotomo Fomon101	pinza tagliente per il setto
MEYERDING divaricatori74	Periostotomo Joseph101	nasale Luc.....119
Micro forbici34	Periostotomo OBWEGSER149	Pinza torcifili Berry.....97
Micro forbici35	PIERCE Elevatore per setto103	Pinza USA 1x2 denti37
Micro forbici33	Pinza 1 x 2 denti Potts-Smith36	Pinza USA p.dissezione36
Micro pinze ad anello.....48	Pinza 1x2 denti McIndoe42	Pinze 1x2 denti Gillies43
Micro pinze Halsted-Mosquito60	Pinza 5x6 denti Lerche41	pinze 1x2 denti Semken43
Micro pinze per legature47	pinza a baionetta Taylor.....44	Pinze Adson, chirurgiche39
micro portaghi Barraquer.....95	pinza anatomica McIndoe42	Pinze Adson,
micro portaghi Castroviejo.....96	Pinza anatomica Bonney.....45	chirurgiche/anatomiche38
MICROVASCULAR portaghi93	pinza anatomica Cushing41	Pinze Adson-Brown, chirurgiche....40
MIDDLETON JANSEN pinza	Pinza anatomica Potts-Smith36	Pinze anatomiche Durante45
per il setto nasale123	Pinza auricolare Jansen-Gruenwald...57	pinze anatomiche Gerald.....43
Miller divaricatore86	Pinza auricolare Wilde (Troeltsch).....57	pinze anatomiche Semken43
Mini-Lambotte osteotomo132	pinza chirurgica 1x2 Gerald.....43	Pinze anatomiche Stille36
MINI-LANGENBECK Endo	Pinza chirurgica Cushing.....41	Pinze atraumatiche DeBakey50
dissettore77	Pinza chirurgica Stille37	Pinze atraumatiche DeBakey51
MOELTGEN goniometro2	pinza con cucchiaio, modello russo...42	Pinze auricolari Lucae57
MYLES pinza nasale tagliente.....121	Pinza depilatoria Barraquer55	Pinze auricolari Troeltsch57
	Pinza emostatica Adson64	Pinze chirurgiche 2x3 denti37
N	Pinza fenestrata Collin-Duval42	Pinze chirurgiche 3x4 denti37
Neivert-Anderson Osteotomo130	Pinza fenestrata Duval42	Pinze chirurgiche 4x5 denti37
News gancio per tracheotomia90	Pinza morsi dentellati Graefe41	Pinze chirurgiche Brown.....41
	Pinza nasale Heymann-Knight118	Pinze chirurgiche Ferris-Smith42
O	pinza nasale tagliente Myles121	Pinze chirurgiche Gerald44
O'BRIEN forbici taglia fili28	pinza nasale tagliente Schmeden.....121	Pinze chirurgiche Stille-Barraya.....45
OBWEGESER divaricatore146	pinza nasale tagliente Takahashi.....121	Pinze chirurgiche Waugh.....41
OBWEGESER divaricatore147	Pinza p. diss. 1x2 denti.....37	Pinze da presa per endoscopia157
OBWEGESER divaricatore148	pinza p.dissezione.micro43	Pinze emostatiche Coller-Crile61
OBWEGESER Osteotomo131	Pinza per appiattamento setto	pinze emostatiche Crile62
OBWEGESER periostotomo149	nasale Rubin.....122	Pinze emostatiche Crile-Rankin62
OCHSNER pinza per dissezione....45	Pinza per columella Cottle57	Pinze emostatiche Hartmann59
O'Connor divaricatore.....86	Pinza per dissezione Ochsner45	Pinze emostatiche Kelly61
OLSEN HEGAR portaghi.....93	Pinza per il setto Knight118	Pinze emostatiche Kelly-Rankin61
osteotomo Cottle129	pinza per il setto nasale Brünings.....119	Pinze emostatiche Leriche63
Osteotomo Mini-Lambotte132	pinza per il setto nasale Graig119	Pinze emostatiche
Osteotomo nasale Silver130	pinza per il setto nasale	Providence-Hospital61
Osteotomo nasale West132	Middleton Jansen123	Pinze emostatiche
Osteotomo Neivert-Anderson130	Pinza per medicature Lubet-Baron ...117	Rochester-Ochsner63

Indice Italiano

HADEO
INSTRUMENTE GERMANY

Pinze emostatiche Rochester-Pean	63	Raspa nasale Peet	134	SILVER osteotomo nasale	130
Pinze fissatrici Green.....	56	raspa nasale Wiener.....	134	SILVERSTEIN separatori mammari.....	83
Pinze Halsted-Mosquito.....	60	REDA coltello falcato	125	SINGLEY pinze per tessuti.....	45
Pinze muscolari Berke.....	55	Regolo metal.grad.mm/pollici	2	Sinus elevatore per setto	103
Pinze per calazio Desmarres.....	55	Retratore nasale Freer	88	Spatola.....	80
Pinze per dissezione chirurgiche.....	37	Retratore nasale Kilner.....	88	Spatole addominali Ribbon.....	66
chirurgiche/anatomiche	36	Retratore nasale Maliniac.....	87	Spazzolino	138
Pinze per iride Bishop-Harmann.....	53	Retratore nasale Masing-Neivert.....	87	Specoli nasali.....	112
Pinze per iride Graefe.....	52	Retrattori nasali Aufricht	87	Specoli nasali Cottle	115
Pinze per schegge.....	46	Retrattori nasali Converse	87	Specoli nasali Cottle	116
Pinze per sutura Castroviejo	55	Retrattori nasali Cottle	87	Specoli nasali Hartmann	111
Pinze per sutura mod. Bonn	54	Retrattori nasali Cottle	88	Specoli nasali Hartmann-Halle	110
Pinze per sutura mod. Tuebingen.....	54	Retrattori nasali Fomon	88	Specoli nasali Killian	113
Pinze per tessuti Singley	45	Retratore nasale Cottle-Neivert	88	Specoli nasali Killian	114
Pinze torcibili Mayo-Haberisser	97	REYNOLDS forbici per dissezione	19	Specoli nasali Tieck-Halle	112
Pitanguy strumento per marcare	3	RIBBON spatole addominali.....	66	Specoli nasali, mod. Wien.....	112
Placca per palpebre	58	ROCHESTER OCHSNER		SPENCER forbici taglia fili.....	28
portaghi Baby Olsen-Hegar	93	pinze emostatiche.....	63	SPINA-NASALIS divaricatore.....	148
portaghi Baby-Webster.....	91	ROCHESTER PEAN pinze		STEVENS forbici delicate.....	24
portaghi Baumgartner	92	emostatiche	63	STILLE pinza chirurgica.....	37
portaghi Crile-Wood	92	Rollet divaricatore.....	86	STILLE pinze anatomiche	36
portaghi DeBakey	92	ROUX mini divaricat.doppio.....	65	STILLE-BARRAYA pinze	
portaghi Derf	91	RUBIN osteotomo	129	chirurgiche.....	45
portaghi Halsey	91	RUBIN pinza per appiattamento		STRANDELL-STILLE divaricatori.....	74
portaghi Mayo-Hegar	92	setto nasale	122	Strumenti per labbra e palato	105
portaghi microvascular	93	Russel-Davis abbassalingua	145	Strumenti per labbra e palato Blair	106
portaghi Olsen-Hegar	93	RYDER portaghi	93	strumento per marcare	
portaghi Ryder	93	S		D'Assumpaco.....	3
portaghi tagliente Gillies	94	SANVENERO forbici per		strumento per marcare Lockwood.....	3
portaghi Webster.....	91	dissezione.....	18	strumento per marcare McKissock	4
POTTS SMITH pinze anatomiche	36	scalpello per plastica nasale		strumento per marcare Pitanguy	3
POTTS-SMITH pinza 1 x 2 denti	36	Cottle	129	Strumento per marcare, Freemann	4
Providence-Hospital pinze		Schink Dermatomo	5		
emostatiche	61	SCHMEDEN pinza nasale			
Q		tagliente	121		
QUISLING martello intranasale	100	sega nasale angolata Joseph.....	139		
R		sega nasale Joseph.....	138		
RAGNEL divaricatore doppio.....	65	SEMKEN pinze 1x2 denti	43		
RAMUS divaricatore	148	SEMKEN pinze anatomiche	43		
raspa nasal Dingman.....	138	Separatori mammari Agris-Dingman.....	82		
raspa nasale Aufricht	135	Separatori mammari			
raspa nasale doppia Fomon	136	MacCollum-Dingmann	83		
raspa nasale doppia Fomon	137	Separatori mammari Silverstein	83		
Raspa nasale Glabella	134	Separatori mammari Tebbetts.....	83		
raspa nasale Joseph Lewis	135	Sgorbia Freer.....	132		
raspa nasale Maltz	134	Sgorbia Hajek.....	132		
raspa nasale Maltz (Cottle).....	135	Sgorbia Killian.....	130		
Raspa nasale Parkes	134	Sgorbia Killian-Claus	132		
		Sgorbia nasale West.....	132		
		Sgorbia periostotomo Boies	102		
		Silver dermatomo	6		
				T	
				TAKAHASHI pinza nasale	
				tagliente	121
				TAYLOR pinza a baionetta	44
				TAYLOR pinza anatomica	44
				TAYLOR pinza chirurgica 1x2.....	44
				Tebbetts divaricatori.....	78
				TEBBETTS Separatori mammari.....	83
				Telaio solo per DAVIS BOYLE.....	142
				Telaio solo per DAVIS MEYER.....	144
				Telaio solo per DINGMANN.....	143
				Telaio solo per Kilner-Doughty.....	143
				Tessier divaricatore	150
				TESSIER Osteotomo.....	151
				TieCK HALLE specoli nasali	112
				Tritacartilagine Cottle.....	133
				Tritacartilagine Jost.....	133
				Troeltsch pinze auricolari.....	57
				TYRELL uncinetto acuto.....	69

U	
Uncinetto acuto Frazier.....	70
Uncinetto acuto Graefe.....	69
uncinetto acuto per pelle Kleinert-Kutz	70
Uncinetto acuto Tyrell	69
Uncinetto doppio acuto Guthrie	69
Uncinetto doppio per pelle Humby.....	71
Uncinetto doppio smusso Guthrie.....	69
Uncinetto per pelle Barsky.....	71
Uncinetto smusso Frazier	70
Uncinetto smusso Graefe	69
Uncini per dura-madre Adson.....	85
Uncini per nervi Crile	85
Uncini per nervi Cushing	85
Uncini per nervi destra e sinistra	77
Uncini per pelle Anderson.....	79
Uncino mucosa Joseph	70
V	
VOLKMANN divaricatori	73
W	
Wagner forbici delicate	25
WALSHAM pinza per raddrizzare il setto nasale.....	140
WALTER/CONVERSE/WILMER forbici delicate.....	22
Watson dermatomo	6
WAUGH pinze chirurgiche.....	41
WEBSTER portaghi.....	91
WEIL BLAKESLEY pinza tagliente nasale	120
WEITLANER divaricatori	76
WEST osteotomo nasale	132
WEST sgorbia nasale	132
WESTMACOTT pinza per medicature	117
WIEDER abbassalingua	141
Wiener divaricatori.....	86
WIENER raspa nasale.....	134
Wilde (Troeltsch) pinza auricolare	57
WILLIGER dissettori	101
WILMER/CONVERSE/WALTER forbici delicate.....	22
Y	
YANCOSKIE divaricatori.....	79



Weitere Kataloge und Prospekte
Other cataloges and prospects

Hauptkatalog Chirurgische Instrumente
General catalog surgical instruments

Arthroskopie
Arthroscopy

Container Steriltechnik
Container Sterilization Technique

Endoskopie
Endoscopy

Neurochirurgie
Neuro Surgery

Orthopädie
Orthopedic

Titan Instrumente
Titanium Instruments

HADEO
INSTRUMENTE GERMANY

