

HADEO

INSTRUMENTE GERMANY



Cirugía general
Cirugía cardiovascular
Cirugía maxilofacial
Cirugía mínimamente invasiva
Cirugía plástica
Ginecología
Oftalmología
Odontología
Urología
Neurología
Otorrinolaringología
Traumatología
Ortopedia



instrumental médico quirúrgico







Generalkatalog
General Catalogue
Catálogo General





HADEO



HADEO



Charrière (Ch) French (F)	Durchmesser in mm	Inches
1	0,33	0,013
2	0,67	0,025
3	1,00	0,039
4	1,33	0,051
5	1,67	0,065
6	2,00	0,0787
7	2,33	0,092
8	2,67	0,105
9	3,00	0,1181
10	3,33	0,131
11	3,67	0,144
12	4,00	0,1575
13	4,33	0,170
14	4,67	0,184
15	5,00	0,1968
16	5,33	0,210
17	5,67	0,223
18	6,00	0,2362
19	6,33	0,249
20	6,67	0,263
21	7,00	0,2756
22	7,33	0,288
23	7,67	0,302
24	8,00	0,3150
25	8,33	0,328
26	8,67	0,341
27	9,00	0,3543
28	9,33	0,367
29	9,67	0,380
30	10,00	0,3973
31	10,33	0,407
32	10,67	0,420
34	11,33	0,446
36	12,00	0,4724
38	12,67	0,494
40	13,33	0,5199
45	15,00	0,5905

Gauge (G)	Durchmesser in mm	Inches
35	0,13	0,005
34	0,18	0,007
33	0,20	0,008
32	0,23	0,009
31	0,25	0,010
30	0,30	0,012
29	0,33	0,013
28	0,36	0,014
27	0,41	0,016
26	0,46	0,018
25	0,51	0,020
	0,53	0,021
24	0,56	0,022
23	0,64	0,025
22	0,71	0,028
21	0,81	0,032
20	0,89	0,035
	0,97	0,038
19	1,07	0,042
18	1,27	0,050
17	1,50	0,059
16	1,65	0,065
15	1,83	0,072
14	2,11	0,083
13	2,41	0,095
12	2,77	0,109
11	3,05	0,120
10	3,40	0,134
9	3,76	0,148
8	4,19	0,165
7	4,57	0,180
6	5,16	0,203

1 OZ	0,028 ml
5 OZ	0,140 ml
16 OZ	0,450 ml

35 OZ	1,0 l
128 OZ	3,7 l

GARANTIE / WARRANTY / GARANTIA / GARANZIA

GARANTIE

Wir gewähren auf alle HADEO - Instrumente 3 Jahre Garantie.
Voraussetzung ist der sach- und fachgerechte Einsatz der Instrumente.
Von der Garantie sind Verschleißerscheinungen ausgeschlossen.

WARRANTY

Our HADEO products are free from manufacturing defects in material and workmanship. We therefore give on all instruments a guarantee of three years provided that the instruments are maintained and cleaned properly and used normally for their intended purpose.

GARANTIA

Estamos convencidos de nuestra calidad y concedemos a todos los instrumentos de HADEO 3 años de garantía contra cualquier defecto de fabricación, siempre y cuando se usen adecuadamente. De la garantía excluimos la manifestación de desgaste.

GARANZIA

Siamo convinti della nostra qualità e concediamo tre anni di garanzia sulla funzione dei tutti gli strumenti HADEO sotto la presupposizione che l'utilizzo è da esperto.
Escluso della garanzia sono tracce di consumo.

Arbeitsanweisung

Aufbereitung (Reinigung) und Sterilisation von resterilisierbaren chirurgischen Instrumenten

Alle von HADEO gelieferten wieder verwendbaren Instrumente wurden ausschließlich für den chirurgischen Gebrauch konstruiert und dürfen zu keinen anderen Zwecken benutzt werden. Unsachgemäße Handhabung und sorglose Pflege sowie zweckentfremdeter Gebrauch können zu vorzeitigem Verschleiß der Instrumente führen. Die Produkte sind bei der Auslieferung nicht sterilisiert.

Reinigungsvorbereitung

Fabrikneue Instrumente müssen vor der ersten Anwendung den gesamten Aufbereitungsprozess durchlaufen. Instrumente unmittelbar nach Anlieferung aus den Folienverpackungen entnehmen und in trockenen Räumen bei gleichbleibender Raumtemperatur luftoffen lagern, um Kondensationsbildung zu vermeiden. Die Instrumente keinen Sonnenlichteinstrahlungen oder Dämpfen durch Chemikalien (Säuren oder scharfe Reinigern) aussetzen. Vor der ersten Sterilisation alle Schutzkappen und Folien vollständig entfernen und anschließend reinigen.

Gebrauchte Instrumente unmittelbar nach Beendigung des Eingriffs von Blut, Gewebe und Arzneimittel reinigen. Instrumente in eine freigegebene Lösung eines kombinierten Reinigungs- und Desinfektionsmittels, das keine proteinfixierende Wirkung besitzt, einlegen. Dosierung des Herstellers beachten. Nicht in NaCl Lösung einlegen, ansonsten Gefahr für Loch- bzw. Spannungsriss-Korrosion

Überfüllung von Instrumentensieben und Wasch-Trays vermeiden.

Gelenkinstrumente vor dem Aufbereiten öffnen. Zerlegbare Instrumente gemäß Bedienungsanleitung (Piktogramm) zur Reinigung zerlegen. Reinigungsgerechtes Zubehör verwenden. Für die manuelle Reinigung nie Metallbürsten oder Metallschwämme verwenden.

Spülmaschinen und Ultraschallanlagen nicht überladen. Spül- oder Schallschatten vermeiden. Dosierung, Einwirkzeit und Einwirktemperatur bei der Desinfektion und Reinigung unbedingt einhalten. Nach der Reinigung sorgfältig spülen. Möglichst vollentsalztes (demineralisiertes) Wasser verwenden.

Nach dem Spülen ausreichend trocknen.

Abgenutzte, korrodierte, deformierte, poröse oder anderweitig beschädigte Instrumente aussortieren.

Aus hygienischen Gründen müssen Instrumente, die zur Reparatur eingesandt werden komplett aufbereitet werden.

Gelenkinstrumente nach jeder Aufbereitung mit einem Pflegemittel auf Basis von Paraffinöl behandeln (gilt nicht für flexible Endoskope und Zubehör).

Funktionsprüfung in zusammengebautem Zustand durchführen.

Instrumente mit Rastensperre vor der Sterilisation nur im ersten Zahn schließen.

Als Sterilisationsverfahren empfehlen wir die Dampfsterilisation (üblicherweise mit Sattedampf bei 134° C)

Sterilisation ist kein Ersatz für Sauberkeit!

IMPORTANT INFORMATION CONCERNING PREPARING AND STERILIZING SURGICAL INSTRUMENTS

Dear Sirs,
please read the following instructions very carefully before using the instruments.

1. INITIAL USE

All instruments which are being used for the first time must be thoroughly cleaned, rinsed and then sterilized before using.

2. TREATING INSTRUMENTS AFTER USAGE

- a.) The instruments might be immediately thoroughly cleaned and disinfected. Please follow the manufacturer's instructions when using cleaning agents and disinfectants.
- b.) Instruments which may be dismantled must be cleaned and disinfected after being taken apart.
- c.) Cleaning may be carried out either manually or with a machine. Care should be taken that only cleaning agents and disinfectants are used, which are changed daily.
- d.) Following chemical disinfection and manual cleaning, all instruments must always be thoroughly rinsed under running water.
- e.) The temperature of water used in a machine for cleaning should not exceed 45°C.
- f.) Whether cleaning is carried out manually or by machine, we especially ask you to ensure that the correct dosage for cleaning solutions or the correct combination of disinfectant and cleaning solution, is employed. Similar importance should be applied to the length of time the agents require to perform properly and to the temperature set.
- g.) Hinged instruments should be opened before cleaning.
- h.) Please ensure that the perforated instrument trays, when loaded, do not exceed 10 kg in weight.
- i.) Please take care that when instruments are being cleaned they are arranged proper in a manne that fluids can circulate freely.
- j.) Deposits remaining after the cleaning process must be completely removed in the first rinse which now follows. The optimum temperature for final rinsing has proved to be between 70° and 90° C. Please use only purified water in this final cleaning stage.
- k.) The instruments must be carefully dried after cleaning and rinsing is completed.
- l.) Moving parts and the cutting edges of shears and scissors must be treated with preservatives which are both suitable and physiologically safe.

3. TESTING FOR CORRECT FUNCTIONING

- a.) Instruments must be carefully and thoroughly checked before every occasion that they are used.

- b.) After each time they are cleaned, the instruments must be macroscopically clean, i.e., visibly free from proteinbased residues and other soiling.
- c.) Care should be taken so that cracks, breakages and corrosion are noticed.
- d.) Instruments with flecks should be separated and taken out for special treatment.
- e.) All moving parts as well as working tips and blades should be checked with special care.
- f.) Checking should be carried out according to the extent to which the instruments will be used.
- g.) Instruments which are in any way defective or damaged should be immediately sorted out from the others.

4. STERILIZATION

- a.) All stainless steel surgical instruments supplied by us may be sterilized in an autoclave.
- b.) Please follow the manufacturer's operating instructions when using autoclave. All machines used must comply with all current quality and other standards.
- c.) Instruments are being sterilized/ autoclaved at a temperature of 134°C.
- d.) Sterilization packing material must comply with all current standards.
- e.) Instruments with ratchets or self-retaining mechanisms should be sterilized opened or in the first ratchet position.
- f.) Please ensure that perforated instrument trays, when loaded do not exceed 10 kg in weight.

5. IN GENERAL

- a.) All surgical instruments supplied by us have been thoroughly inspected before dispatch and leave our factory in perfect condition. Damage which can arise as a result of transporting, cleaning, preserving, sterilizing or storing, must be prevented.
- b.) Please handle surgical instruments always with the utmost care.
- c.) Instruments must be stored in a clean and dry place.
- d.) If you have any queries or problems please contact us at any time:

We should like to point out that, if the above-mentioned directions are not followed or the instruments supplied by us are not properly used, all guarantee claims become void and any consequences must be borne by yourselves.

SUGERENCIAS PARA LA LIMPIEZA, ESTERILIZACIÓN Y MANTENIMIENTO DE INSTRUMENTOS QUIRÚRGICOS

ENJUAGADO

Tras el uso enjuagar enseguida los instrumentos bajo un chorro de agua caliente (no hirviendo). El enjuagado debe servir para quitar los residuos de sangre, mucosas y tejidos.

LIMPIEZA

Si la limpieza no se efectúa inmediatamente después del enjuagado, los instrumentos tienen que sumergirse en una solución de agua y detergente con PH neutro (7)

Para los instrumentos muy delicados (algunos tipos de porta agujas o tijeras se aconseja una limpieza manual: ver punto "C").

a.- Limpieza en la pila de ultrasonido

Los instrumentos tienen que estar en la pila el tiempo necesario recomendado por el fabricante para efectuar el ciclo del lavado, generalmente de 5 a 10 minutos.

Los instrumentos con bisagras o juntas (articulaciones) tienen que sumergirse en la pila en posición abierta.

Asegurarse de que las hojas afiladas de las tijeras, bisturíes para gingivectomía, curetas, etc. no estén en contacto con otros instrumentos.

Todos los instrumentos deben estar completamente sumergidos en la solución de lavado.

No poner instrumentos de diferentes metales (acero inoxidable, instrumentos cromados, latón, etc.) en el mismo ciclo de lavado.

Cambiar a menudo la solución para el lavado, como mínimo todas las veces que lo recomienda el fabricante de la pila de ultrasonidos.

Enjuagar concienzudamente los instrumentos con agua corriente tras lavado con ultrasonidos para quitar los residuos de la solución de lavado.

b.- Limpieza con lavadora

Seguir las indicaciones del fabricante. Asegurarse de que los instrumentos hayan sido lubricados tras el último ciclo de lavado y antes del ciclo de esterilización.

c.- Limpieza manual

La mayor parte de los fabricantes de instrumentos indican el lavado con los ultrasonidos como el modo mejor y más eficaz para limpiar los instrumentos quirúrgicos, especialmente los que tienen bisagras, cierres y en general articulaciones. Si la limpieza con los ultrasonidos no es posible, se aconseja usar el método siguiente:

- Usar cepillos rígidos de plástico, nylon, etc.
- Cepillar concienzudamente los instrumentos más delicados y, si es posible, enjuagar, limpiar y esterilizar estos instrumentos separadamente.
- Verificar que toda la superficie de estos instrumentos esté limpia.
- Tras haber cepillado los instrumentos, enjuagarlos bajo el chorro de agua corriente.
- Durante el enjuagado abrir y cerrar las tijeras, las pinzas hemostáticas, los porta agujas y los demás instrumentos con bisagras o juntas y asegurarse de que las partes internas de las bisagras estén perfectamente enjuagadas como la superficie externa del instrumento.

SECADO, LUBRIFICACIÓN E INSPECCIÓN

Tras las operaciones de limpieza y de enjuagado, los instrumentos quirúrgicos tienen que ser secados perfectamente.

Todos los instrumentos con juntas o bisagras (acción "metal contra metal") como tijeras, pinzas hemostáticas, porta agujas, fórceps de extracción, etc., tienen que ser lubricados. Se aconsejan lubricantes específicos para el instrumental quirúrgico. No usar aceites o lubricantes industriales.

A este punto es buena norma inspeccionar el estado de cada instrumento y verificar el funcionamiento según el uso específico. Controlar y asegurarse de que:

- Las hojas de las tijeras estén lisas de arriba abajo y de que, una vez cerradas, no hagan juego. Probar las tijeras cortando gasa muy fina. Tres cuartas parte de la hoja tienen que cortar la gasa sin retenerla.
- Las puntas de las pinzas estén al mismo nivel.

- Las pinzas hemostáticas y los porta agujas no dejen pasar la luz entre las puntas cuando estén cerradas, se abran y cierren fácilmente y que las bisagras no estén demasiado flojas.
- Controlar el desgaste de la porta agujas sobre la superficie interna de las puntas.
- Las cánulas metálicas de aspiración estén bien limpias en su interior.
- Los instrumentos cortantes y los bisturíes tengan las hojas bien afiladas y no estropeadas.

ESTERILIZACIÓN EN AUTOCLAVE

Tras haber enjuagado, limpiado, secado, lubricado e inspeccionado los instrumentos, éstos pueden ser preparados para la esterilización separadamente o en serie.

Instrumentos individuales:

Las bolsas especiales monouso son el ideal para contener los instrumentos. Asegurarse de que las bolsas que contendrán los instrumentos con cierres y articulaciones (pinzas hemostáticas, porta agujas, etc.) sean lo bastante grandes como para contener los citados instrumentos en posición abierta.

Instrumentos en serie:

Poner los instrumentos en los especiales cestos o bandejas de acero inoxidable. Poner los instrumentos más pesados en la parte inferior cuando sean necesarias varias bandejas.

No cerrar nunca los instrumentos durante el ciclo en autoclave. Un instrumento cerrado no estará nunca bien esterilizado, ya que el vapor no puede penetrar en la parte de cierre a contacto "metal contra metal". En el instrumento podría además romperse en la parte de la bisagra a causa de la expansión del metal debida al calor durante el ciclo del autoclave.

No cargar demasiado la cámara del autoclave ya que algunos instrumentos podrían formar "zonas de sombra" sobre otros en los que el vapor no penetraría.

ATENCIÓN

Al final del ciclo de esterilización - antes del ciclo de secado- abrir ligeramente la portezuela del autoclave y preceder con el ciclo desecado según las instrucciones del fabricante. Si la portezuela del autoclave se abriese completamente antes del ciclo de secado, el aire frío de la habitación entraría en la cámara del autoclave causando la formación de condensación sobre los instrumentos y de consecuencia aparecerían las manchas de agua que vemos a menudo en los mismos.

ESTERILIZACIÓN EN FRÍO:

La mayor parte de las soluciones para la esterilización en frío esterilizan los instrumentos completamente tras 10 horas de inmersión. Esta acción química prolongada puede ser más perjudicial para los instrumentos que el ciclo normal de 20 minutos en autoclave.

Si los instrumentos tienen necesidad de ser simplemente "desinfectados", el proceso en frío es adecuado, ya que la desinfección tiene lugar en 10 minutos solamente.

Recuerde bien la diferencia entre:

ESTÉRIL - término absoluto (ningún organismo logra sobrevivir) y

DESINFECTADO - perfectamente limpio.

Usen siempre la técnica más adecuada de esterilización/limpieza de los instrumentos según el uso que se haga posteriormente de ellos.

Recuerden que la esterilización de los instrumentos no sustituye la limpieza de los mismos.

Recomendamos no volver a usar ni esterilizar los artículos de un solo uso.

Si se tratan en el modo correcto los instrumentos contruidos con las modernas aleaciones inoxidables pueden durar muchos años.

INDICAZIONI PER LA CURA, PULITURA E LA STERILIZZAZIONE DELLO STRUMENTARIO CHIRURGICO RISTERILIZZABILE

Misure preventive anticorrosione

- 1) Raggruppare accuratamente gli strumenti correttamente confezionati e sterilizzati prima dell'operazione; selezionarli secondo l'intervento. Verificare sempre che la confezione esterna sia integra e che lo strumento stesso non sia danneggiato.
 - 2) Assicurarsi tramite l'indicatore di sterilizzazione collocato all'interno del vaglio che il contenuto sia stato sterilizzato.
 - 3) Disporre gli strumenti seguendo l'ordine di utilizzo durante l'operazione; lasciare gli strumenti non necessari nel vaglio; predisporre gli strumenti solo immediatamente prima dell'operazione.
 - 4) Nel corso dell'operazione rimuovere dagli strumenti sangue ed altri materiali biologici; dopo l'uso, riporre gli strumenti nel corretto alloggiamento.
 - 5) Risciacquare opportunamente gli strumenti cavi, al fine di evitare l'adesione di sangue e polvere d'osso.
 - 6) Per la pulitura degli strumenti utilizzare una soluzione lattata o una soluzione salina, ma non immergerli nelle suddette soluzioni.
 - 7) Iniziare l'operazione di pulitura subito dopo l'intervento. Strumenti utilizzati su pazienti con possibili infezioni: smaltire in modo analogo, eliminando sangue, polvere d'osso parti di tessuto in eccesso.
 - 8) Pulire gli strumenti in un luogo previsto nell'ambito della sala operatoria.
- Nel caso in cui gli strumenti vadano collocati direttamente nella centrale di sterilizzazione, è necessario dapprima coprirli, per evitare il rischio di contaminazione ai danni del personale o dell'ambiente circostante.

Disinfezione

Durante l'uso di disinfettanti chimici è necessario osservare scrupolosamente le indicazioni del produttore; utilizzare le soluzioni sempre previa diluizione. Nella fase termica di disinfezione con acqua bollente assicurarsi che l'acqua sia priva di corpi estranei.

Pulitura

Indipendentemente dal metodo utilizzato per la pulitura (meccanico o manuale) si raccomanda di verificare attentamente quale detergente vada utilizzato con ciascun metodo. Valori pH consigliati: tra 7,0 e 8,5.

1) Pulitura meccanica

Osservare scrupolosamente le istruzioni d'uso fornite dal produttore della macchina pulitrice. Predisporre gli

strumenti per la pulitura meccanica. Tutti gli strumenti appuntiti e delicati dovrebbero essere puliti manualmente.

Non sovraccaricare i vagli, mettere gli strumenti pesanti sul fondo del vaglio. Se necessario, immergere e risciacquare gli strumenti molto sporchi (strumenti cavi), prima di collocarli nella lavatrice.

2) Pulitura ad ultrasuoni

(fa parte dei metodi di pulitura meccanica)

Prima di inserire uno strumento nel bagno ad ultrasuoni, rimuovere i materiali organici in eccesso. I bagni ad ultrasuoni sono consigliati per le filettatrici o gli strumenti con solchi profondi. L'ultrasuono deve essere seguito da un programma di risciacquo normale.

3) Pulitura manuale

Richiede diverse spazzole in nylon, una canna da soffio ed un ugello da soffio/ un dispositivo ad aria compressa pulito, detergenti e solventi come per la pulitura meccanica.

Per gli additivi di pulitura osservare le indicazioni fornite dal produttore.

Per la pulitura degli strumenti dotati di cannula, passare più volte lo spazzolino di nylon attraverso la cannula eseguendo movimenti rotatori (non utilizzare spazzole in lana d'acciaio/metallo) fino alla completa rimozione dei residui eliminabili con questo metodo.

Soffiare poi con aria compressa nella cannula.

4) Asciugatura

Ogni strumento deve essere asciugato completamente sia internamente che esternamente per evitare la formazione di ruggine o malfunzionamenti.

Indicazioni per la sterilizzazione della strumentazione

Pulire immediatamente ed asciugare bene gli strumenti usati, non utilizzare detergenti e disinfettanti con additivi fortemente acidi o alcalini (ad es. soda, soda caustica o acidi)!

Sterilizzare la strumentazione solo a vapore A 134°!

Prima della sterilizzazione, assicurarsi che gli strumenti siano perfettamente funzionanti ed integri. La sterilizzazione non sostituisce la pulitura.



HADEO

Index

03: Diagnostik
 05: Narkose
 07: Skalpelle, Messer
 09: Scheren
 10: Mikroscheren
 11: Pinzetten
 12: Mikrochirurgie-Pinzetten

 13: Klemmen
 15: Tuchklemmen
 17: Tupferzangen
 19: Wundhaken
 21: Sonden, Watteträger
 23: Trokare, Biopsiekanülen, Führungsnadeln
 25: Nadelhalter
 27: Naht
 29: Sterilisations-Instrumente

 31: Verband, Gips
 33, 34: Knochenchirurgie
 41: Neurochirurgie
 43, 44: Ophthalmologie
 45: Otologie
 47: Rhinologie
 49: Mund und Zunge
 51: Tonsillektomie
 53: Laryngo-, Bronchoskopie
 55: Tracheotomie
 57: Thorax
 61: Herz- und Gefäßchirurgie
 63: Galle
 65: Magen, Darm
 67: Urologie
 69: Rektum
 71: Gynäkologie
 73: Geburtshilfe
 75: Dermatologie
 89: Sterilisation, Behälter
 91: Hochfrequenz-Chirurgie

Index

Diagnostic
 Anesthesia
 Scalpels
 Scissors
 Micro Scissors
 Thumb and Tissue Forceps
 Microsurgery Forceps
 Atrauma Bulldog Clamps
 Hemostatic Forceps
 Towel Forceps
 Dressing Forceps
 Retractors
 Probes, Cotton Applicators
 Trocars

 Needle Holders
 Suturing Instruments
 Sterilization Instruments

 Plaster of Paris
 Bone Surgery
 Neurosurgery
 Ophthalmology
 Otology
 Rhinology
 Mouth and Tongue
 Tonsils
 Larynx
 Tracheotomy
 Thorax
 Cardiovascular Surgery
 Gall and Kidney
 Intestines, Stomach
 Urology
 Rectum
 Gynecology
 Obstetrics
 Dermatology, Hygiene
 Different Containers
 High Frequency Surgery

Indice

03:	Diagnóstico
05:	Anestesia
07:	Bisturíes
09:	Tijeras
10:	Tijeras p/micro cirugía
11:	Pinzas de disección
12:	Pinzas p/micro cirugía Clamp Atrauma Bulldog
13:	Pinzas hemostáticas
15:	Pinzas de campo
17:	Pinzas p/tapones
19:	Separadores
21:	Sondas, Porta-algodón
23:	Trócares
25:	Porta-agujas
27:	Instrumentos para sutura
29:	Instrumentos para la esterilización
31:	Vendajes enyesados
33, 34:	Cirugía ósea
41:	Neurocirugía
43, 44:	Oftalmología
45:	Otología
47:	Rinología
49:	Boca y lengua
51:	Amígdalas
53:	Laringe
55:	Traqueotomía
57:	Tórax
61:	Cirugía cardiovascular
63:	Vesícula biliar
65:	Intestinos, Estómago
67:	Urología
69:	Recto
71:	Ginecología
73:	Obstetricia
75:	Dermatología, Higiene
89:	Contenedores varios
91:	Electrocirugía

Index

Diagnostica
Anestesia
Bisturi
Forbici
Forbici per microchirurgia
Pinze per dissezione
Pinze per microchirurgia
Pinze Atrauma Bulldog
Pinze emostatiche
Pinze fissateli
Pinze per medicatura
Divaricatori
Sonde, Portacotone
Trequarti
Port'aghi
Strumenti per suture
Strumenti per la sterilizzazione
Bendaggi gessati
Chirurgia ossea
Neurochirurgia
Oftalmologia
Otologia
Rinologia
Bocca e lingua
Tonsille
Laringe
Tracheotomia
Torace
Chirurgia cardiovascolare
Vescicola biliare, rene
Intestini, Stomaco
Urologia
Retto
Ginecologia
Ostetrica
Dermatologia, Igiene
Vassoi diversi
Elettrochirurgia

HADEO Ltda. wurde im Jahr 1978 in Bogotá, Kolumbien, gegründet. Ziel der Firmengründung war der Vertrieb von chirurgischen Instrumenten.

In den 35 Jahren ihres Bestehens hat sich die Firma HADEO zu einem bekannten und zuverlässigen Partner der Ärzteschaft in Kolumbien entwickelt. Sie stellt ihren Kunden Instrumente von hoher Qualität zur Verfügung, und sieht ihre Aufgabe darin, die Erwartungen ihrer Kunden stets zu erfüllen. Aus diesem Grunde bietet die Firma HADEO Dienstleistungen und Produkte von hoher Qualität.

Motivierte Mitarbeiter tragen mit ihrer Selbständigkeit und ihrem persönlichen Engagement wesentlich zum Erfolg der Firma bei, was eine positive Auswirkung auf die Geschäftsbeziehung zu unseren Kunden hat.

HADEO vertreibt chirurgische Instrumente in den Bereichen:

- Allgemein- und Viszeralchirurgie
- Gefäß-, Mikro- und Neurochirurgie
- Herz- und Toraxchirurgie
- Gynäkologie und Urologie
- HNO, Ophthalmologie
- Orthopädie
- Plastische Chirurgie
- Laparoskopie
- Endo- Neurochirurgie
- Arthroskopie
- Sinuskopie
- Cytoskopie
- Hysteroskopie

Die Firma HADEO bietet eine hohe Lieferbereitschaft und Flexibilität mit der Absicht die volle Zufriedenheit ihrer Kunden zu gewährleisten.



HADEO

Hadeo Ltda. was founded in 1978 in Bogotá, Colombia, with the purpose to provide high quality surgical instruments.

During over 35 years of its existence HADEO has become a well known and reliable partner for the medical profession. HADEO is committed to meet the expectations of its clients and therefore offers its services together with first-class products.

The personal engagement and independent work of the employees played an important part in the success of HADEO, as well as in the positive relationship with our clients.

HADEO is able to offer a complete range of surgical instruments such as:

- General and Visceral Surgery
- Micro- Neuro- and Vascular Surgery
- Heart- and Thorax Surgery
- Gynaecology
- ENT, Ophthalmology
- Orthopaedics, etc.
- Laparoscopy
- Endo- Neurosurgery
- Arthroscopy
- Urology
- Plastic Surgery
- Sinuscopy
- Cystoscopy
- Hysteroscopy

HADEO LTDA can offer its customers a fast and efficient service from a large stocked warehouse, striving to guarantee the full satisfaction of its clients.



HADEO

HADEO Limitada fue fundada en el año de 1978 en Bogotá, Colombia, con el propósito de distribuir instrumentos quirúrgicos de la más alta calidad.

Durante los más de 35 años de su existencia la empresa HADEO se ha convertido en un proveedor bien conocido y responsable para el cuerpo médico en el país. Ofrece instrumental de primera calidad y presta sus servicios con el fin de cumplir en la mejor forma las expectativas de sus clientes.

Nuestro equipo de trabajo contribuye al éxito de la empresa con su compromiso y su entusiasmo, lo cual incrementa una relación favorable con la clientela.

Nuestras especialidades en cirugía incluyen instrumentos para:

- Cirugía general y visceral
- Cirugía vascular, micro cirugía, neurocirugía
- Cirugía cardiovascular
- Ginecología y urología
- ORL, oftalmología
- Ortopedia
- Cirugía plástica
- Laparoscopia
- Endo-neurocirugía
- Artroscopia
- Sinuscopia
- Cistoscopia
- histeroscopia

HADEO LTDA dispone de un surtido stock lo cual nos permite despachar con prontitud y flexibilidad con el fin de lograr la mayor satisfacción de nuestros clientes.

Nystagmusbrille
Nystagmus spectacles
Anteojos para nistagmo
Occhiali nistagmo



FRENZEL

03167-03
Beleuchtete Nystagmusbrille
mit querliegendem Batterie-
handgriff und festen Gläsern

Energiequelle:
2 Stück 4-Volt-Lämpchen
2 Stück Baby-Zellen 1.5 V

03167-03
Anteojos para nistagmo, con
iluminación, con mango para
pilas en forma horizontal,
vidrios fijos,

Alimentación:
2 unidades de bombillos de
4 voltios
2 unidades de pilas de
1.5 voltios

03167-03
Nystagmus spectacles for
observation of the eyes during
examination of the vestibular
apparatus, with battery handle
and fixed glasses. Illuminated
on inside of lenses.

Source of energy:
2 bulbs 4-volt
2 baby-battery cells 1.5 V

03167-03
Occhiali Nistagmo illuminati
con manopolo a batteria,
lenti fisse.
Per la rilevazione della reazione
patologica del nistagmo.

Alimentazione:
2 lampadine 4 Volt
2 batterie 1,5 Volt

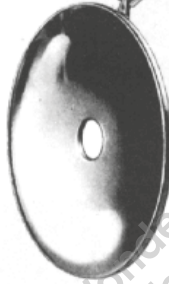
Stirnspiegel
Head Mirror
Espejos frontales
Specchi frontali



03180-93
ø 90 mm



ZIEGLER
03180-90
compl.



03180-92

03180-90
Ziegler-Stirnspiegel,
komplett, mit schwarzem
Stirnreifen,
mit Kugelgelenk,
90 mm ø

03180-90
Ziegler Head Mirror,
complete with black head
band, with ball socket,
90 mm ø

03180-90
Ziegler espejo frontal, com-
pleto con cinta negra,
con articulación,
90 mm ø

03180-90
Specchio frontale, Ziegler,
completo con fascia nera,
con snodo sferico,
90 mm di ø

03180-92
Stirnstreifen, allein

03180-92
head band, only

03180-92
cinta, suelta

03180-92
fascia, sola

03180-93
Spiegel, allein
90 mm ø

03180-93
Mirror, only
90 mm ø

03180-93
Espejo, suelto
90 mm ø

03180-93
Specchio,
solo 90 mm ø

Stirnlampe
Head Light
Lámpara frontal
Lampada frontale



CLAR
03195-00

komplett mit Stirnstreifen und Kabel
complete with head band and cable
completo con cinta frontal y cable
completa con fascia frontale e cordone



03195-01
ø 55 mm

Spiegel aus Glas ohne Fassung
Glass Mirror without frame
Reflector de cristal, sin montura
Riflettore di cristallo, senza montatura



03195-06
6 Volt



03195-07 Kleintransformator
220 Volt = 0 - 10 Volt / 3 Watt
Mini-Transformer Unit
Transformador eléctrico pequeño
Mini-trasformatore elettrico

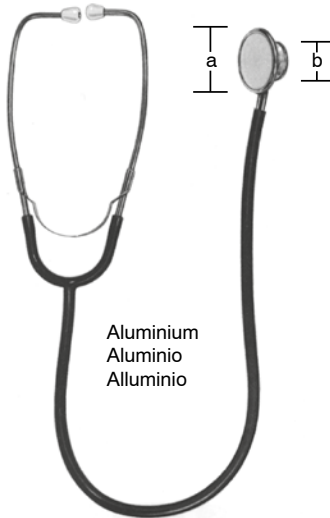
03195-08 Kleintransformator
110 Volt = 0 - 10 Volt / 3 Watt
Mini-Transformer Unit
Transformador eléctrico pequeño
Mini-trasformatore elettrico

03195-09 CLAR-Spiegel-Gelenkverbindung
CLAR special socket joint
Articulación especial de CLAR
Snodo speciale di CLAR

03195-04 Stirnstreifen, alleine
head band, only
cinta frontal, suelta
fascia frontale, sola

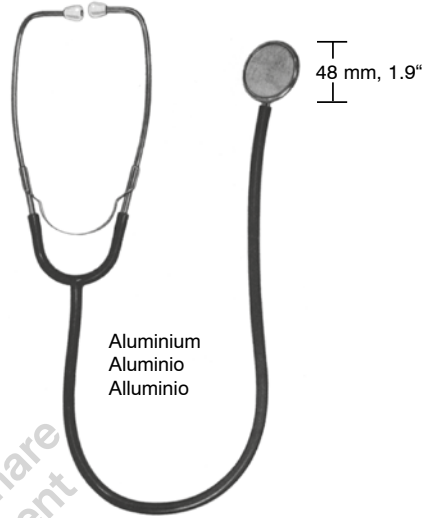
03195-10 CLAR Kopfspange allein aus
Metall mit Kabelaschen und
Fixierschraube mit Gelenk
CLAR spring metal head band
only, with cable clips and fixing
screw with socket joint
Casco frontal de resorte metálico
suelto de CLAR, con bridas de
cable, y tornillo de sujeción con
articulación
Fascia metallica a casco di CLAR,
solo, con portacordoni e vite di
fissaggio a snodo

Stethoskope
Stethoscopes
Estetoscopios
Stetoscopi



Aluminium
Aluminio
Alluminio

DUPLEX



Aluminium
Aluminio
Alluminio

ANESTOPHON
03248-00

	a	b	
03246-00	48 mm, 1.9"	30 mm, 1.2"	
03246-01	39 mm, 1.5"	25 mm, 1.0"	Baby
03246-02	21 mm, 0.8"	21 mm, 0.8"	Neonatal



PINARD
03260-15 15 cm, 6"
ALU



PINARD
03262-18 18 cm, 7"

Holz, wood, madera, legno

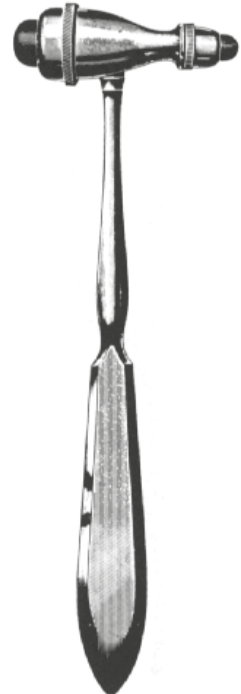
Perkussionshämmer
Percussion Hammers
Martillos de percusión
Martelli da percussione



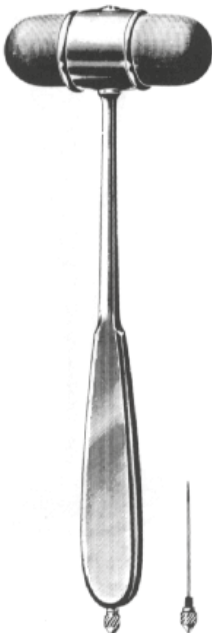
TAYLOR - USA Mod.
03288-17 17 cm, 6 3/4"
03288-20 20 cm, 8"



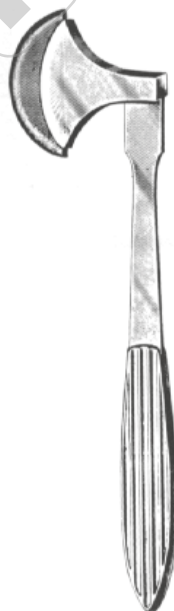
BABINSKY
03292-22 22 cm, 8 3/4"



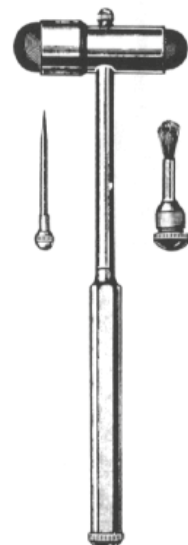
TROEMNER
03294-24 24 cm, 9 1/2"



DEJERINE
03304-20 20 cm, 8"



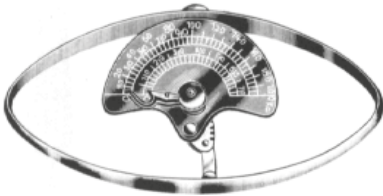
BERLINER
03306-17 17 cm, 6 3/4"



BUCK
03308-18 18 cm, 7"

Prüf- und Meßinstrumente Examination and Measuring Instruments Instrumentos para exámenes y medidas Strumenti per esaminare e misurare

Dynamometer
Dynamometer
Dinamómetro
Dinamometro

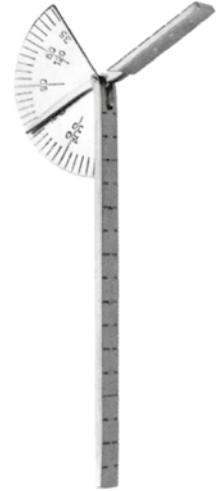


COLLIN
03310-01 Erwachsene, Adult,
adultos, adulti
03310-02 Kind, child, niños, bambini

Winkelmesser
Goniometer
Goniómetro
Goniometro



MOELTGEN
03312-01



Finger-Goniometer
Finger goniometer
Goniómetro para dedos
Goniometro per le dita
03314-01



WARTENBERG
03320-19 19 cm, 7 1/2"



Wachstuchbandmaß
Tape Measure, oil cloth
Cinta métrica, tela encerada
Metro a nastro in tela cerata

03350-15 1,8 m

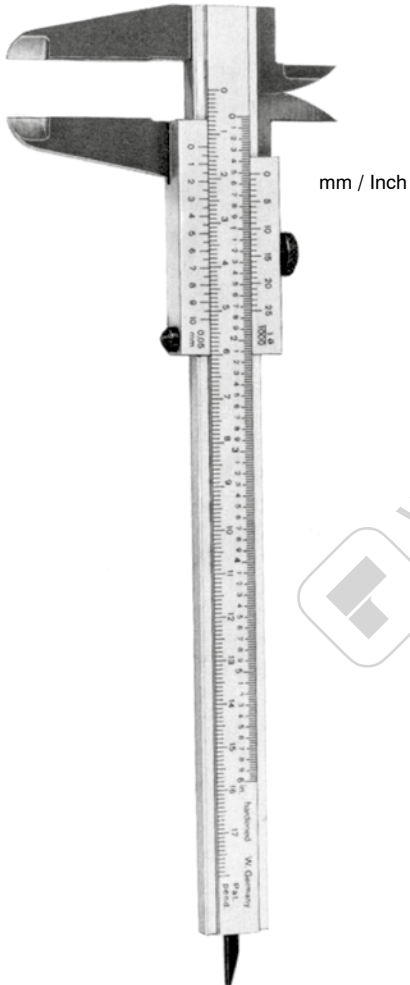
mm / Inch



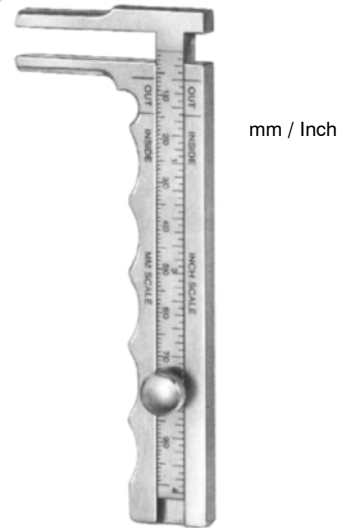
Metall

03340-10	10 cm	4"
03340-15	15 cm	6"
03340-20	20 cm	8"
03340-30	30 cm	12"
03340-50	50 cm	20"

Schieblehren
Calipers
Calibres
Calibro



03360-21
21 cm, 8 1/4"



TOWNLEY
03361-10
11,5 cm, 4 1/2"

Saugrohre
Suction tubes
Tubos de aspiración
Cannule per aspirazione



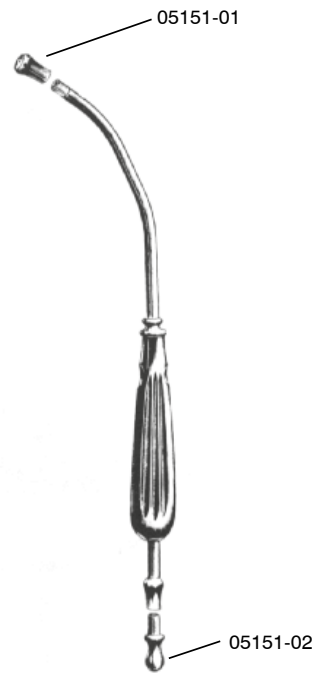
POOLE 20 cm, 8"
05130-05 5.5 mm ø, 0.2"
(17 Fr.)

05130-10 10 mm ø, 0.4"
(30 Fr.)



POOLE 19 cm, 7 1/2"
05140-05 5.5 mm ø, 0.2"
(17 Fr.)

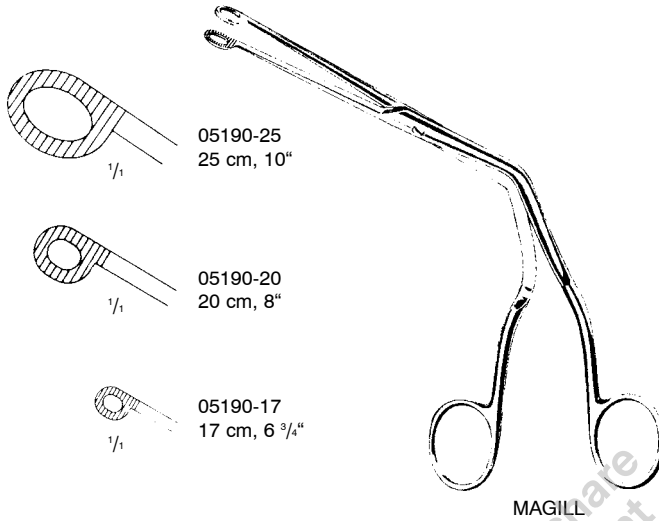
05140-08 8 mm ø, 0.3"
(23 Fr.)



BABY-YANKAUER, compl.
05150-21 21 cm, 8 1/4"

YANKAUER, compl.
05150-27 27 cm, 10 1/2"

Kathetereinführzangen, Saugrohre
 Catheter Introducing Forceps, Suction tubes
 Pinzas para catéteres, Tubos de aspiración
 Pinze per introdurre le sonde, Cannule per aspirazione



05190-25
25 cm, 10"

05190-20
20 cm, 8"

05190-17
17 cm, 6 3/4"

MAGILL



ANDREW-PYNCHON

05170-24
6 mm ø, 1/2"
24 cm, 9 1/2"



COOLEY
05160-02
8 mm ø, 0.3"
36 cm, 14 1/4"



COOLEY
05160-03
8 mm ø, 0.3"
30 cm, 11 3/4"



DE BAKEY
05160-04
3 mm ø, 0.1"
27 cm, 10 1/2"

Laryngoskope
Laryngoscopes
Laringoscopios
Laringoscopi



McINTOSH

Fig. 0	5,5 cm	2 1/4"	05210-00
Fig. 1	7,5 cm	3"	05210-01
Fig. 2	9,0 cm	3 1/2"	05210-02
Fig. 3	11,0 cm	4 3/8"	05210-03
Fig. 4	13,5 cm	5 1/4"	05210-04

Cold light
05211-00
05211-01
05211-02
05211-03
05211-04



05239-03
Halogen-Lampe
Halogen Lamp
Lámpara Halógena
Lampada Alogena



05239-01
f./p. Fig. 0-1



05239-02
f./p. Fig. 2-4



FOREGGER

Fig. 0	5,5 cm	2 1/4"	05220-00
Fig. 1	7,0 cm	2 3/4"	05220-01
Fig. 2	9,0 cm	3 1/2"	05220-02
Fig. 3	11,0 cm	4 3/8"	05220-03
Fig. 4	13,5 cm	5 1/4"	05220-04

Cold light
05221-00
05221-01
05221-02
05221-03
05221-04



05239-03
Halogen-Lampe
Halogen Lamp
Lámpara Halógena
Lampada Alogena



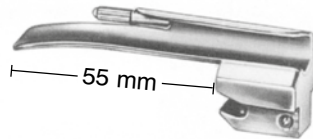
05239-01
f./p. Fig. 0-1



05239-02
f./p. Fig. 2-4

Laryngoskope
Laryngoscopes
Laringoscopios
Laringoscopi

MILLER



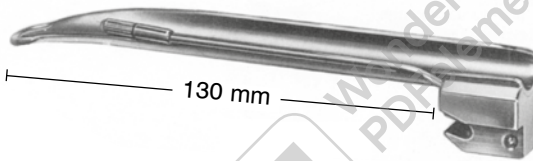
05230-00
55 mm, 2 1/2"
Nutzlänge
working length
largo útil
lunghezza utile

für Säuglinge
for babies
para neonatales
per neonati



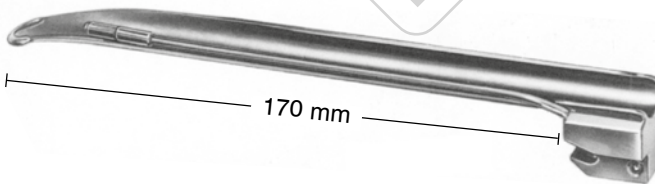
05230-01
80 mm, 3 1/8"
Nutzlänge
working length
largo útil
lunghezza utile

für Kinder
for children
para niños
per bambini



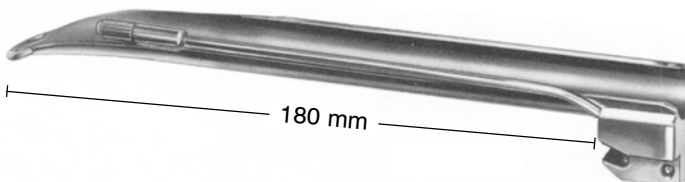
05230-02
130 mm, 5"
Nutzlänge
working length
largo útil
lunghezza utile

für Jugendliche
for adolescents
para adolescentes
per adolescenti



05230-03
170 mm, 6 3/4"
Nutzlänge
working length
largo útil
lunghezza utile

für Frauen
for women
para mujeres
per donne



05230-04
180 mm, 7"
Nutzlänge
working length
largo útil
lunghezza utile

für Männer
for men
para hombres
per uomini

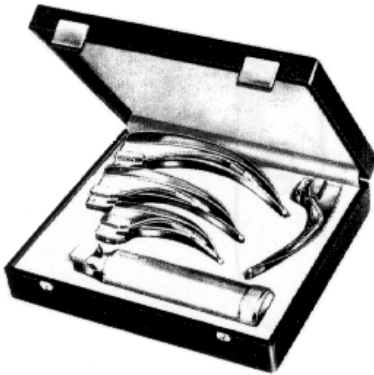


05239-01
f./p. Fig. 0-1



05239-02
f./p. Fig. 2-4

Laryngoskope
Laryngoscopes
Laringoscopios
Laringoscopi



McINTOSH



FOREGGER

05203-00

Set bestehend aus:
1 Etui
1 Batteriegriff 05234-28
3 Spatel (Fg. 1-3)

Set consisting of:
1 Case
1 Handle
3 Blades (Fg. 1-3)

Juego compuesto de:
1 Estuche
1 Mango
3 Hoja (Fg. 1-3)

Set composto da:
1 Astuccio
1 Manico
3 Spatole (Fg. 1-3)

05204-00

Set bestehend aus:
1 Etui
1 Batteriegriff 05234-28
4 Spatel (Fg. 1-4)

Set consisting of:
1 Case
1 Handle
4 Blades (Fg. 1-4)

Juego compuesto de:
1 Estuche
1 Mango
4 Hoja (Fg. 1-4)

Set composto da:
1 Astuccio
1 Manico
4 Spatole (Fg. 1-4)

05223-00

Set bestehend aus:
1 Etui
1 Batteriegriff 05234-28
3 Spatel (Fg. 2-4)

Set consisting of:
1 Case
1 Handle
3 Blades (Fg. 2-4)

Juego compuesto de:
1 Estuche
1 Mango
3 Hoja (Fg. 2-4)

Set composto da:
1 Astuccio
1 Manico
3 Spatole (Fg. 2-4)

05224-00

Set bestehend aus:
1 Etui
1 Batteriegriff 05234-28
4 Spatel (Fg. 1-4)

Set consisting of:
1 Case
1 Handle
4 Blades (Fg. 1-4)

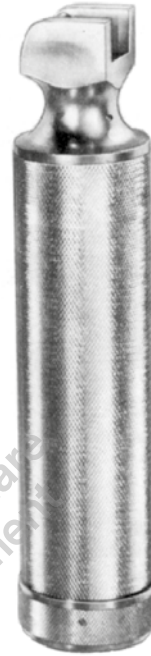
Juego compuesto de:
1 Estuche
1 Mango
4 Hoja (Fg. 1-4)

Set composto da:
1 Astuccio
1 Manico
4 Spatole (Fg. 1-4)

Batteriegriffe, Warmlicht
Battery handles, warm light
Mango de pila, luz caliente
Manico a batteria, luce calda



05233-18 18 mm \varnothing , $\frac{3}{4}$ "



05234-28 28 mm \varnothing , 1"
05234-37 37 mm \varnothing , 1 $\frac{1}{2}$ "



05238-01 30 mm \varnothing , 1 $\frac{1}{4}$ "

Batteriegriffe, Kaltlicht
Battery handles, cold light
Mango de pila, luz fria
Manico a batteria per luce fredda

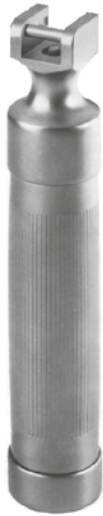


05238-02
18 mm \varnothing
3/4"

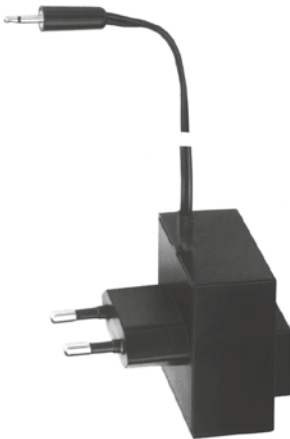


05238-03
30 mm \varnothing
1 1/4"

Batteriegriffe, Warmlicht
 Battery handles, warm light
 Mango de pila, luz caliente
 Manico a batteria, luce calda



05240-30 30 mm ϕ , 1 1/4"
 Griff mit Trafo-Anschluß
 Handle with Transformer-connection
 Mango con conexión al transformador
 Manico con connessione al trasformatore



05241-11 Trafo 120 V
 05241-22 Trafo 230 V

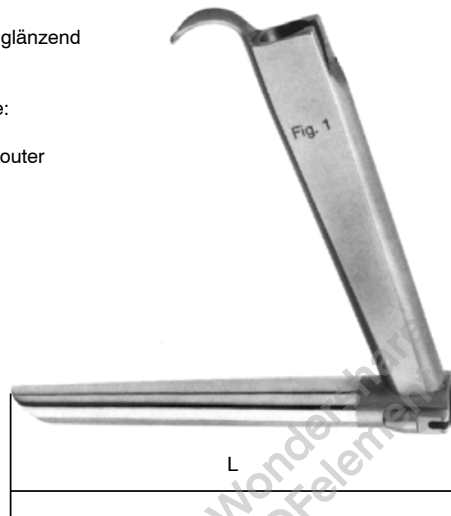
Trafo 120 Volt mit amerikanischem Netzanschluß
 Transformador 120 Volt with american mains connection
 Transformador 120 V con conexión americana
 Trasformatore 120 V ricarica batteria

Trafo 230 Volt mit 1,40 m (55") langem Kabel
 Transformador 230 Volt with cable 1,40 m (55") long
 Transformador, 230 V con cable de 1,40 m (55")
 Trasformatore 230 V ricarica batteria

Laryngoskope Laryngoscopes Laringoscopios Laringoscopi

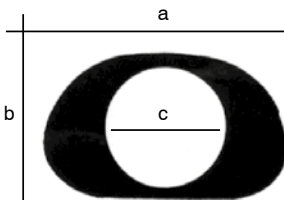
Operation Laryngoskop:
rostfreier Edelstahl
Rohr: innen matt/außen glänzend
Griff: ganz matt

Operation Laryngoscope:
stainless steel
tube: inner surface matt/outer
surface polished
handle: matt

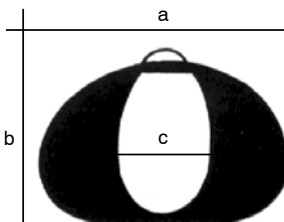


Laringoscopio para operaciones:
Acero inoxidable
Pala: Superficie interior: Mate
Superficie exterior: Brillante
Mango entero: Mate

Laringoscopio a luce
fredda per microchirurgia
endolaringeo
tubo: interiore opaco – esterno lucido
manico: opaco



Nr.	L (mm)	a (mm)	b (mm)	c (mm)	Lichtträger light guide Portador de luz portatore di luce
05301-01	135	21,8	14,0	13,0	05302-01
05301-02	152	22,5	14,8	13,0	05302-01
05301-03	182	23,0	15,0	14,0	05302-02
05301-04	172	29,5	18,0	17,0	05302-02
05301-05	172	31,5	21,5	19,0	05302-02

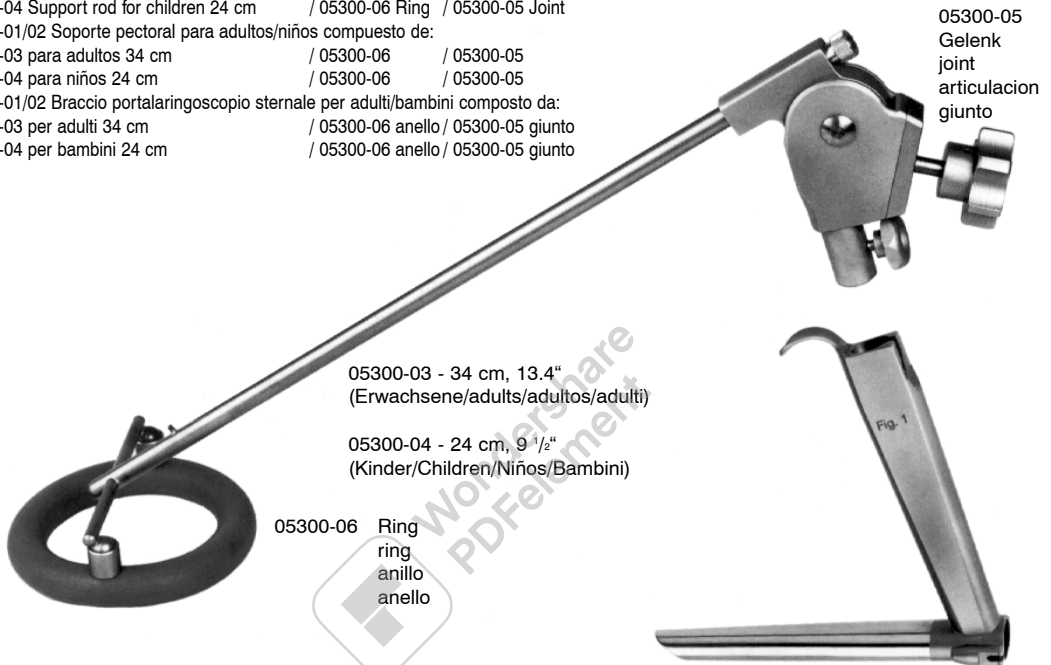


Nr.	L (mm)	a (mm)	b (mm)	c (mm)	Lichtträger light guide Portador de luz portatore di luce
05301-06	182	29,0	20,0	16,0 x 26,0	05302-02
05301-07	222	29,0	20,0	16,0 x 26,0	05302-03

Laryngoskope
Laryngoscopes
Laringoscopios
Laringoscopi

05300-01/02 Bruststütze für Erwachsene/Kinder bestehend aus:
05300-03 Stützstange für Erwachsene 34 cm / 05300-06 Ring / 05300-05 Gelenk
05300-04 Stützstange für Kinder 24 cm / 05300-06 Ring / 05300-05 Gelenk
05300-01/02 Chest Support for adults/children complete consisting of:
05300-03 Support rod for adults 34 cm / 05300-06 Ring / 05300-05 Joint
05300-04 Support rod for children 24 cm / 05300-06 Ring / 05300-05 Joint
05300-01/02 Soporte pectoral para adultos/niños compuesto de:
05300-03 para adultos 34 cm / 05300-06 / 05300-05
05300-04 para niños 24 cm / 05300-06 / 05300-05
05300-01/02 Braccio portalarinoscopio sternale per adulti/bambini composto da:
05300-03 per adulti 34 cm / 05300-06 anello / 05300-05 giunto
05300-04 per bambini 24 cm / 05300-06 anello / 05300-05 giunto

Operationslaryngoskop, Kleinsasser
Operation laryngoscope, Kleinsasser
Laringoscopios operativo, Kleinsasser
Laringoscopi operativo, Kleinsasser



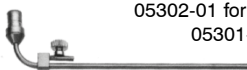
05300-03 - 34 cm, 13.4"
(Erwachsene/adults/adultos/adulti)

05300-04 - 24 cm, 9 1/2"
(Kinder/Children/Niños/Bambini)

05300-06 Ring
ring
anillo
anello

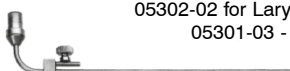
05300-05
Gelenk
joint
articulacion
giunto

Fiberglas-Lichtträger – Fiberglas-light-guide –
Portador de luz fria – portatore di luce fredda
a fibre di vetro



05302-01 for Laryngoskope
05301-01 - 05301-02

05303-01
Injektionskanüle für Laryngoskope: 05301-01 - 05301-07
Injection drain tube for Laryngoscopes: 05301-01 - 05301-07
Canúla de inyeccion para laringoscopios: 05301-01 - 05301-07
Cannula da iniezione per laringoscopi: 05301-01 - 05301-07



05302-02 for Laryngoskope
05301-03 - 05301-06

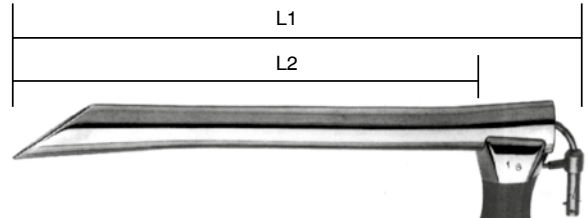
05304-01
Rauchabsaugrohr für Laryngoskop:
Suction tube for Laryngoscopes: 05301-03 - 05301-07
Canúla de succion para laringoscopios: 05301-03 - 05301-07
Tubo di aspirazione per laringoscopi: 05301-03 - 05301-07



05302-03 for Laryngoskope
05301-07

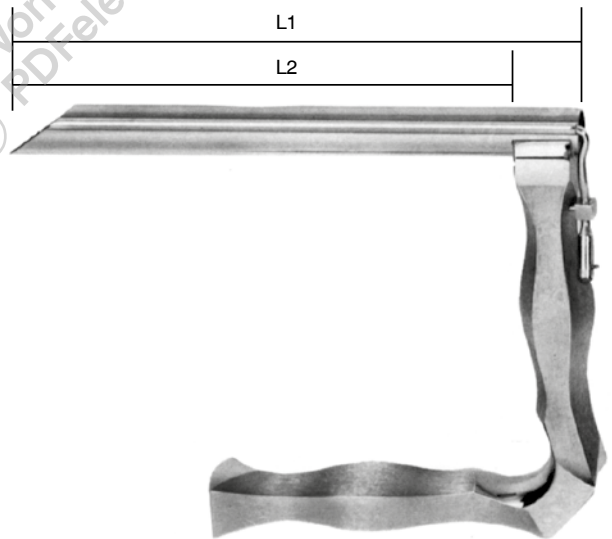


Laryngoskope
Laryngoscopes
Laringoscopios
Laringoscopi



HOLINGER

Nr.	L1	L2	Lichtträger light guide Portador de luz portatore di luce
05310-01	180 mm	157 mm	05311-01
05310-02	170 mm	146 mm	05311-02
05310-03	120 mm	98 mm	05311-03
05310-04	90 mm	77 mm	05311-04



JACKSON

Nr.	L1	L2	Außen-Dm Outer-dm dm-exterior dm-esterno	Innen-Dm Inner-dm dm-interior dm-interno	Lichtträger light guide Portador de luz portatore di luce
05320-01	160 mm	135 mm	17,5 mm	14,5 mm	05321-01
05320-02	160 mm	135 mm	14,5 mm	12,0 mm	05321-02
05320-03	120 mm	105 mm	14,0 mm	11,5 mm	05321-03
05320-04	90 mm	75 mm	13,0 mm	10,0 mm	05321-04

Skalpelli-Griffe
Scalpel Handles
Mangos de bisturíes
Manici per lama bisturi

passend zu den Klängen
for blades
para las hojas
per lama bisturi

- Ⓐ No. 10, 11, 12, 13, 14, 15, 16, 17, 18, 19
Ⓑ No. 20, 21, 22, 23, 24, 25



07103-00

Fig. 3

Ⓐ



07103-01

Fig. 3 grad.

Ⓐ

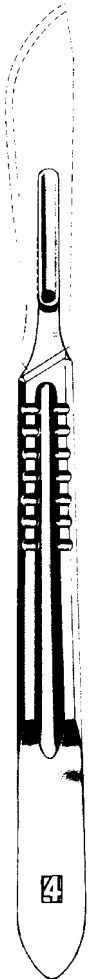


07103-02

Fig. 3 L

Ⓐ

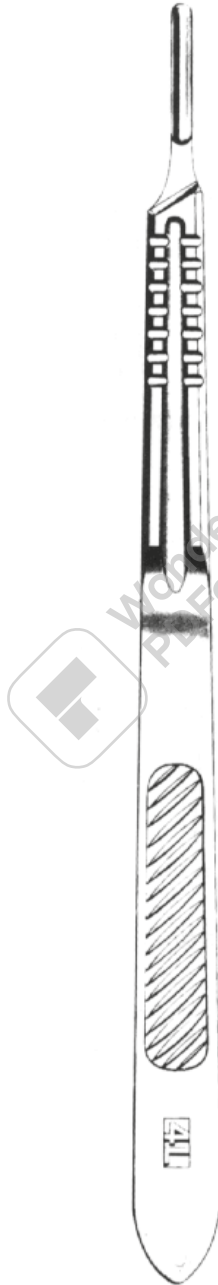
Skalpell-Griffe
Scalpel Handles
Mangos de bisturías
Manici per lama bisturi



07104-00

Fig. 4

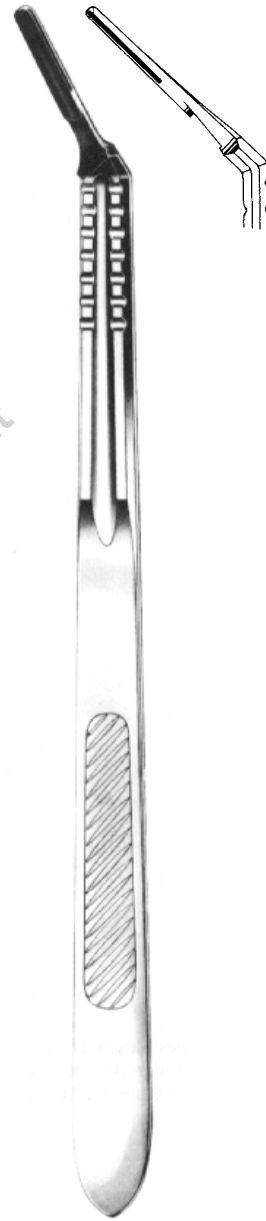
(B)



07104-02

Fig. 4 L

(B)



07105-02

Fig. 4 L

(B)

Skalpelli-Griffe
Scalpel Handles
Mangos de bisturíes
Manici per lama bisturi



07106-01
14,5 cm 5 3/4"

(A)



07106-02
14 cm 5 1/2"

(A)

Skalpelli-Griffe
Scalpel Handles
Mangos de bisturías
Manici per lama bisturi



07107-00
16,5 cm, 6 1/2"
Fig. 7

(A)



07107-01
12 cm, 4 3/4"
Fig. 7K

(A)



07107-03
22,5 cm, 8.9"

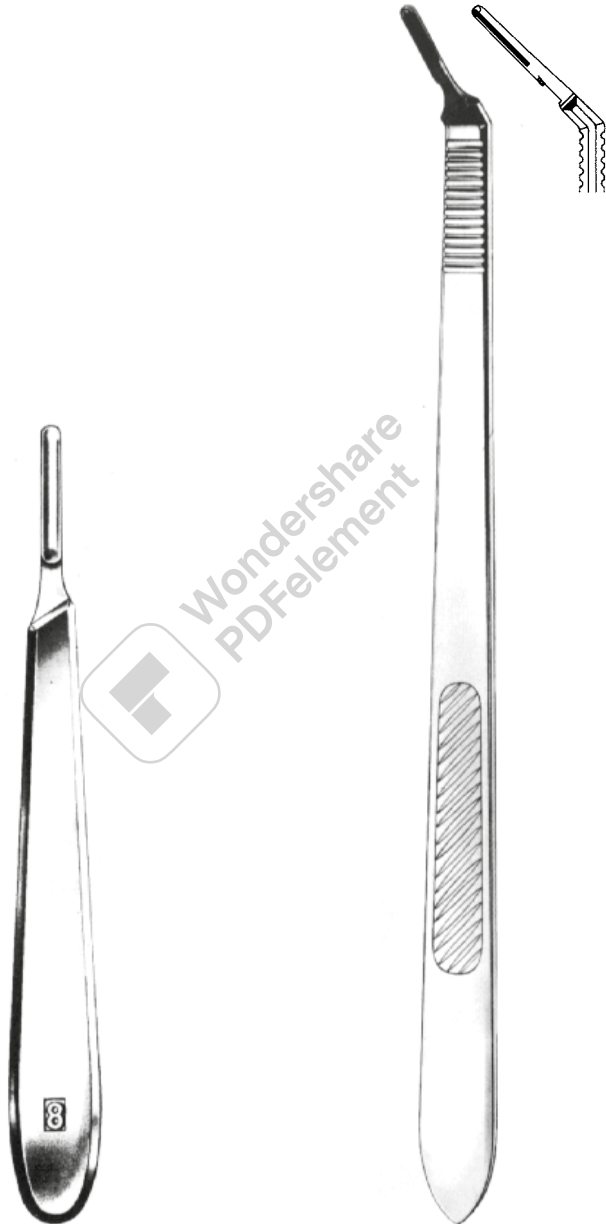
(A)



07107-04
22,5 cm, 8.9"

(A)

Skalpelli-Griffe
Scalpel Handles
Mangos de bisturíes
Manici per lama bisturi



07108-00
Fig. 8

(A)

07109-03
Fig. 3 L

(A)

Skalpell-Griffe
Scalpel Handles
Mangos de bisturías
Manici per lama bisturi

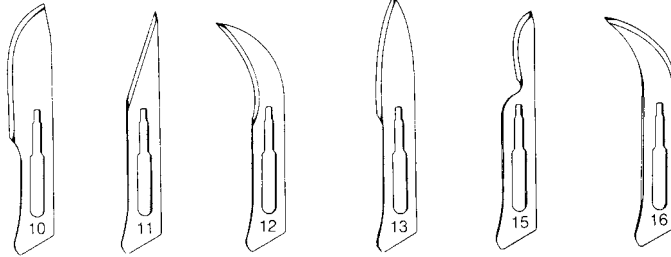


07161-00 07162-00 07165-00 07167-00

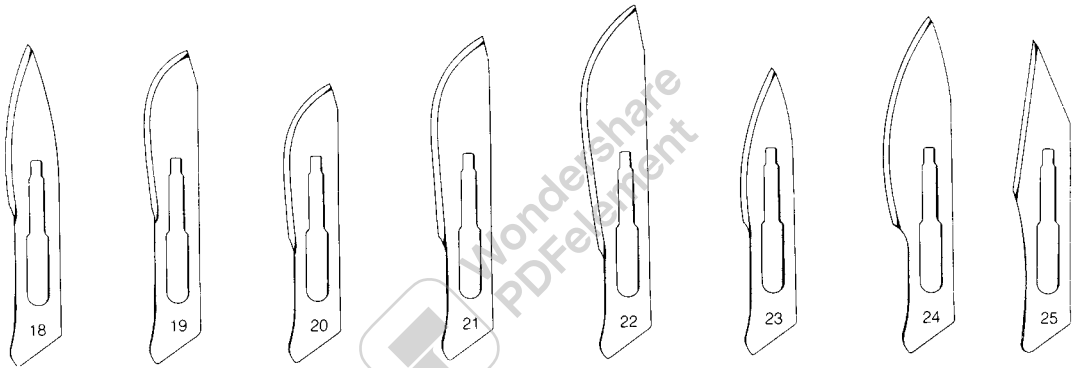
Packung mit 10 Stück
box of 10
en cajas de 10 pzas
confezione di 10

07109-10 10,0 cm, 4"
07109-13 13,0 cm, 5"
07109-15 15,5 cm, 6"

Skalpelli-Klingen, Steril
 Scalpel Blades, Sterile
 Hojas de bisturí, estéril
 Lame per bisturi, sterili



07110-00 07111-00 07112-00 07113-00 07115-00 07116-00



07118-00 07119-00 07120-00 07121-00 07122-00 07123-00 07124-00 07125-00



**Packung mit 100 Stück
 in packages of 100 each
 en cajas de 100 c/u
 confezione di 100 pezzi**

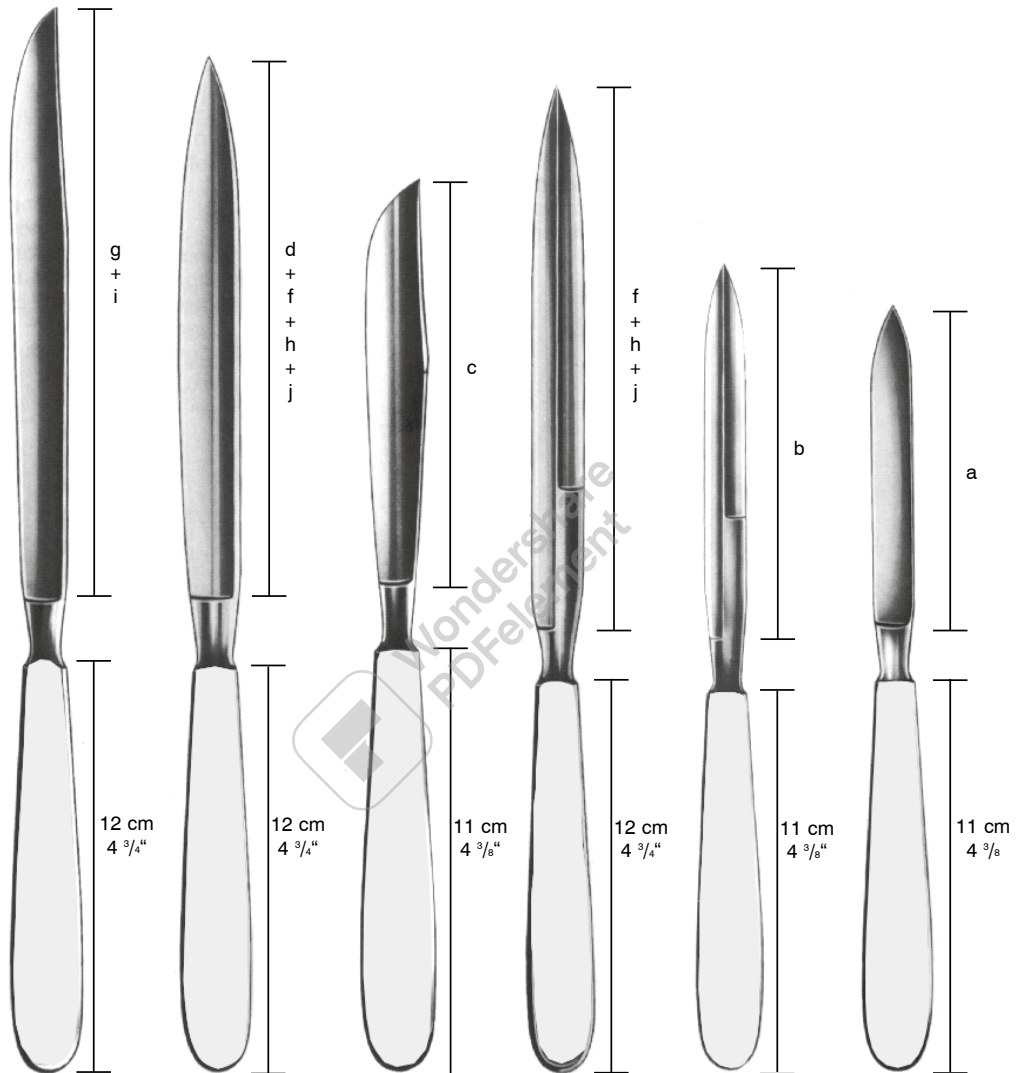
Skalpelli-Klingen-Entferner
 Scalpel Blade Remover
 Quita hojas
 Togliilama



07130-00



Amputationsmesser
Amputation Knives
Cuchillos para amputaciòn
Coltelli per amputazione



LISTON
07200-17
07200-20

HADEO
07201-13
07201-16
07201-19
07201-22

LANGENBECK
07202-12

CATLIN
doppelschneidig
double cutting
filo doble
doppio taglio
07203-16
07203-19
07203-22

07204-11
Zwischenknochen-
messer doppel-
schneidig
Inerosseous knife
double cutting
Cuchillo interóseo
filo doble
Coltello interosseo
doppio taglio

07205-09
Phalangen-
messer
Phalangeal knife
Cuchillos para
falanges
Coltello per falangi

Schnittlänge
Length of blades
Largo de hojas
Lunghezze delle lame

a - 9,5 cm	c - 12,0 cm	e - 15,0 cm	g - 17,0 cm	i - 20,0 cm
b - 11,0 cm	d - 13,0 cm	f - 16,0 cm	h - 19,0 cm	j - 22,0 cm
a - 3 3/4"	c - 4 3/4"	e - 6"	g - 6 3/4"	i - 8"
b - 4 3/8"	d - 5"	f - 6 1/4"	h - 7 1/2"	j - 8 3/4"

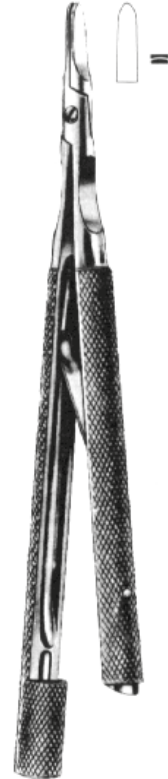
Klingenbrecher, Rasierklingen
 Blade Breakers, Razor Blades
 Rompe-hojas, hojas de afeitar
 Lama di rasoio, Rompilamette



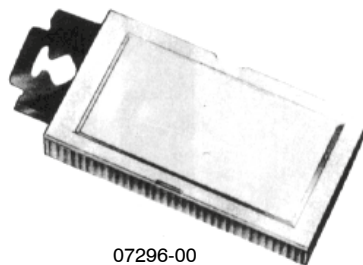
TROUTMAN-CHRIS
 07290-09 9 cm, 3 1/2"



HADEO
 07291-11 11 cm, 4 3/8"



CASTROVIEJO
 07294-13 13 cm, 5 1/8"



07296-00

Packung = 10 Stück
 package = 10 each
 caja = 10 c/u
 confezione = 10 pezzi

Skalpelle mit Metallheft
 Scalpels with Metal Handle
 Bisturíes, mango metálico
 Bisturi, manico di metallo

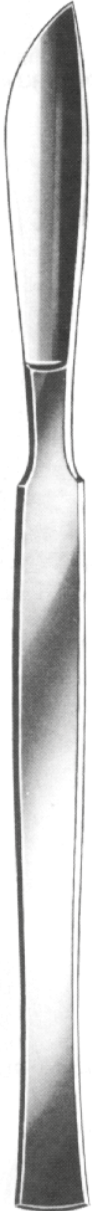


Fig. 1
 07402-01
 15 cm, 6"
 30 mm, 1.2"



Fig. 2
 07402-02
 15 cm, 6"
 36 mm, 1.4"



Fig. 3
 07402-03
 15,5 cm, 6"
 40 mm, 1 1/2"

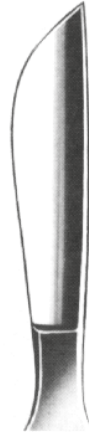


Fig. 4
 07402-04
 16 cm, 6 1/4"
 45 mm, 1 3/4"



Fig. 5
 07402-05
 16 cm, 6 1/4"
 50 mm, 2"



Fig. 6
 07402-06
 15 cm, 6"
 27 mm, 1"



Fig. 7
 07402-07
 15 cm, 6"
 35 mm, 1.4"



Fig. 8
 07402-08
 16 cm, 6 1/4"
 40 mm, 1 1/2"



Fig. 9
 07402-09
 16 cm, 6 1/4"
 47 mm, 1.9"



Fig. 10
 07402-10
 17 cm, 6 3/4"
 50 mm, 2"

Resektions- und Knorpelmesser
 Resection and Cartilage Knives
 Cuchillos para resección/cartilagos
 Coltelli per resezione e cartilagini



6,5 cm
2.6"

6,5 cm
2.6"

5,5 cm
2.2"

18 cm, 7"

LANGENBECK
07412-05

Beinhautmesser
mit Schaber
Periosteum Knife
with raspatory
Cuchillo para
periostio, con
periostótamo
Coltello per
periostio con
raschino

19 cm, 7 1/2"

07403-01

Metallheft
metal handle
mango metálico
manico di metallo

19 cm, 7 1/2"

07403-02

Holzheft
wooden handle
mango de madera
manico in legno

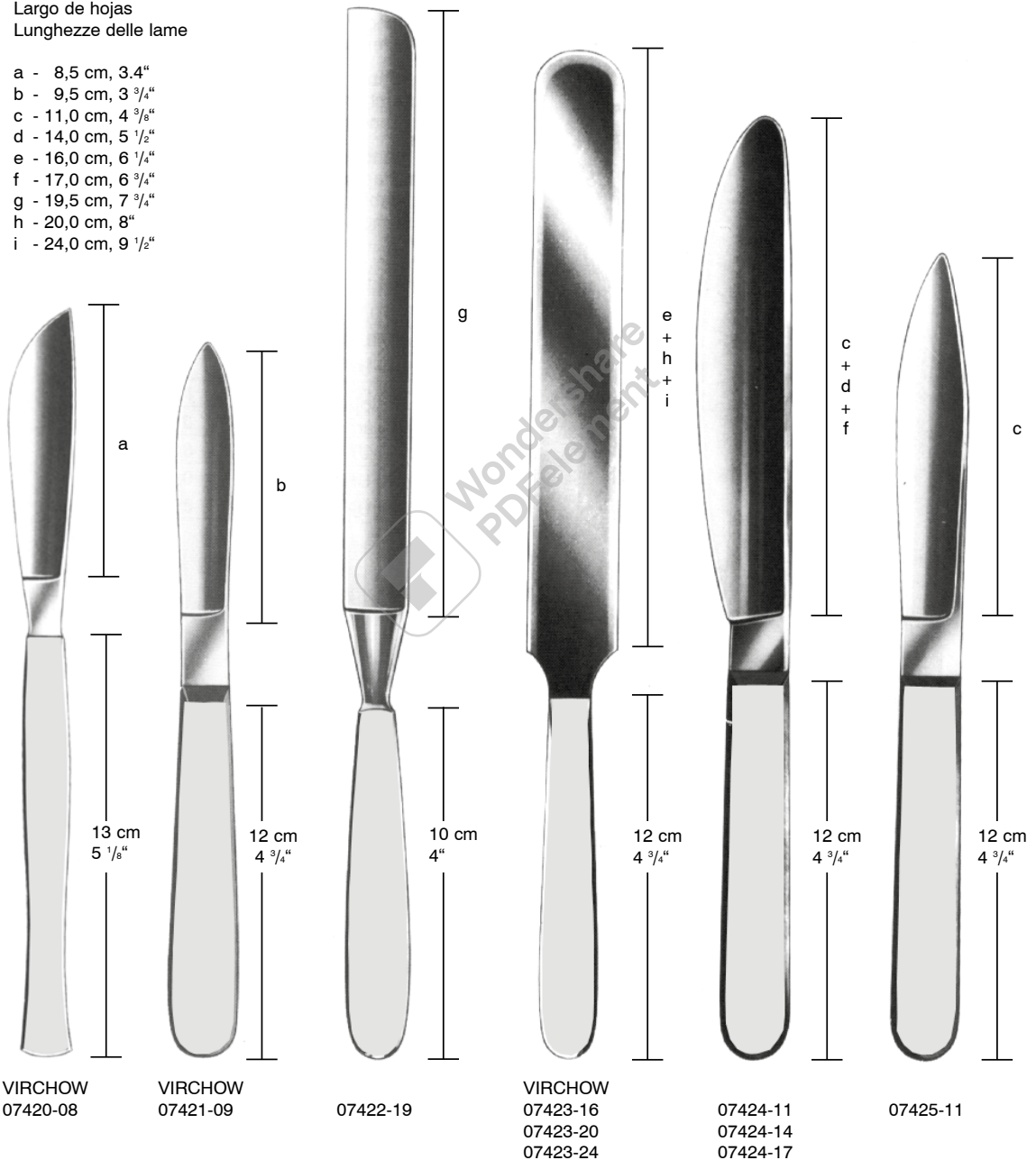
18 cm, 7"

LANGENBECK
07410-05

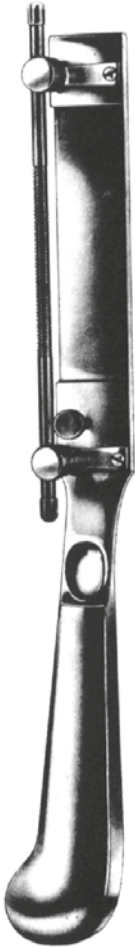
Sezier-, Hirn- und Organmesser
Autopsy- Brain- and Post mortem knives
Cuchillos para autopsia- cerebro- órganos
Coltelli per cartilagini- cervello e organi

Schnittlänge
Length of blades
Largo de hojas
Lunghezze delle lame

- a - 8,5 cm, 3.4"
- b - 9,5 cm, 3 3/4"
- c - 11,0 cm, 4 3/8"
- d - 14,0 cm, 5 1/2"
- e - 16,0 cm, 6 1/4"
- f - 17,0 cm, 6 3/4"
- g - 19,5 cm, 7 3/4"
- h - 20,0 cm, 8"
- i - 24,0 cm, 9 1/2"



Dermatome, Rasiermesser
Dermatome, Razor
Dermátomo, Navajas
Dermatomo, Rasoio

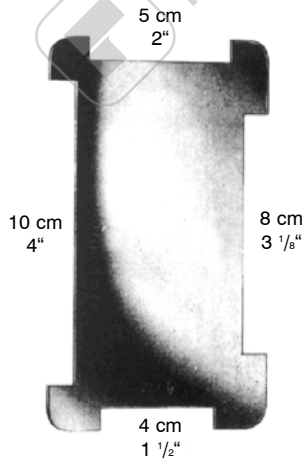


SCHINK
07490-00
30 cm, 11 3/4"
0,1 - 2 mm
compl.
mit/with/con

07490-01 (1) Stk./ pcs/ pzas
07490-02 (2) Stk./ pcs/ pzas



07490-01
Ersatzklinge
Spare blade
Hoja de repuesto
Lama di ricambio per dermatomo



07490-02
Spannplatte
Skin straightening plate
Placa para extender la piel
Placca per stendipelle



07496-00
Rasiermesser 8 cm, 3 1/8"
Razors 8 cm, 3 1/8"
Navajas 8 cm, 3 1/8"
Rasoio 8 cm, 3 1/8"

Dermatome
Dermatome
Dermátomo
Dermatomo



07496-31
Ersatzklingen
Spare blades
Hoja de repuesto
Lame di ricambio



für handelsübliche Rasierklingen
for usual razor blades
para hojas de afeitador usuales
per lamette da barba normali

07296-00
Ersatzklingen
Spare blades
Hoja de repuesto
Lame di ricambio



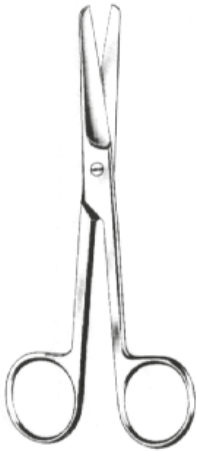
07499-01
Ersatzklingen
Spare blades
Hoja de repuesto
Lame di ricambio

HUMBY
07495-31 31 cm, 12 1/4"
0,1 - 1,5 mm
mit 1 Klinge
with 1 blade
con 1 hoja
con 1 lama

SILVER
07498-00 19 cm, 7 1/2"
mit 1 Klinge
with 1 blade
con 1 hoja
con 1 lama

WATSON
07499-00 30 cm, 11 3/4"
0,1 - 1,5 mm
mit 1 Klinge
with 1 blade
con 1 hoja
con 1 lama

Chirurgische Scheren
Operating Scissors
Tijeras para cirugía
Forbici per chirurgia



STANDARD

09102-11 11,5 cm, 4 1/2"
09102-13 13,0 cm, 5"
09102-14 14,5 cm, 5 3/4"
09104-14 TC
09102-15 15,5 cm, 6"
09102-16 16,5 cm, 6 1/2"
09102-18 18,5 cm, 7 1/4"
09102-20 20,0 cm, 8"



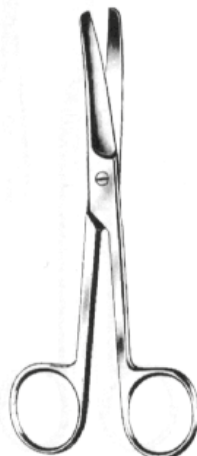
STANDARD

09110-11 11,5 cm, 4 1/2"
09110-13 13,0 cm, 5"
09110-14 14,5 cm, 5 3/4"
09114-14 TC
09110-15 15,5 cm, 6"
09110-16 16,5 cm, 6 1/2"
09110-18 18,5 cm, 7 1/4"
09110-20 20,0 cm, 8"



STANDARD

09120-11 11,5 cm, 4 1/2"
09120-13 13,0 cm, 5"
09120-14 14,5 cm, 5 3/4"
09124-14 TC
09120-15 15,5 cm, 6"
09120-16 16,5 cm, 6 1/2"
09120-18 18,5 cm, 7 1/4"
09120-20 20,0 cm, 8"



STANDARD

09103-11 11,5 cm, 4 1/2"
09103-13 13,0 cm, 5"
09103-14 14,5 cm, 5 3/4"
09105-14 TC
09103-15 15,5 cm, 6"
09103-16 16,5 cm, 6 1/2"
09103-18 18,5 cm, 7 1/4"
09103-20 20,0 cm, 8"



STANDARD

09111-11 11,5 cm, 4 1/2"
09111-13 13,0 cm, 5"
09111-14 14,5 cm, 5 3/4"
09115-14 TC
09111-15 15,5 cm, 6"
09111-16 16,5 cm, 6 1/2"
09111-18 18,5 cm, 7 1/4"
09111-20 20,0 cm, 8"



STANDARD

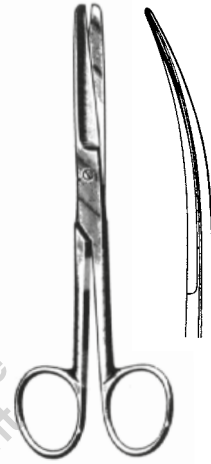
09121-11 11,5 cm, 4 1/2"
09121-13 13,0 cm, 5"
09121-14 14,5 cm, 5 3/4"
09125-14 TC
09121-15 15,5 cm, 6"
09121-16 16,5 cm, 6 1/2"
09121-18 18,5 cm, 7 1/4"
09121-20 20,0 cm, 8"

Chirurgische Scheren
Operating Scissors
Tijeras para cirugía
Forbici per chirurgia

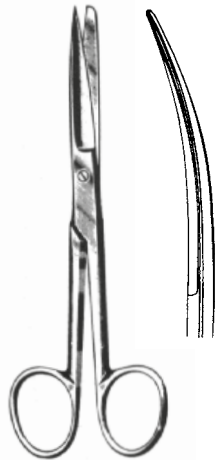


Inzisionsschere
Incision Scissors
Tijera de incision
Forbici per incisione

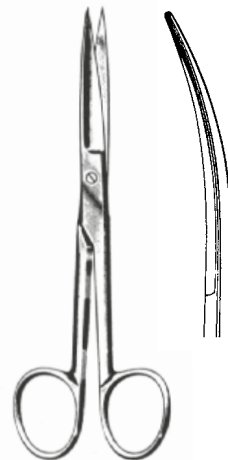
09128-14
14,0 cm
5 1/2"



DEAVER
09130-14 14 cm 09131-14
5 1/2"



DEAVER
09140-14 14 cm 09141-14
5 1/2"



DEAVER
09150-14 14 cm 09151-14
5 1/2"

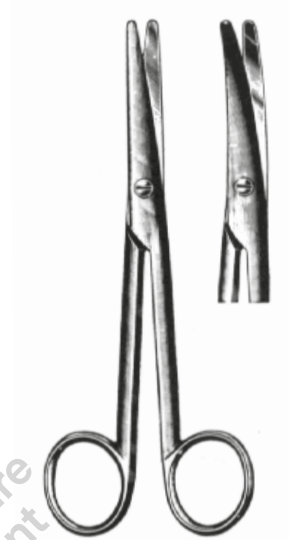


Präparierscheren
Dissecting Scissors
Tijeras de disección
Forbici per dissezione



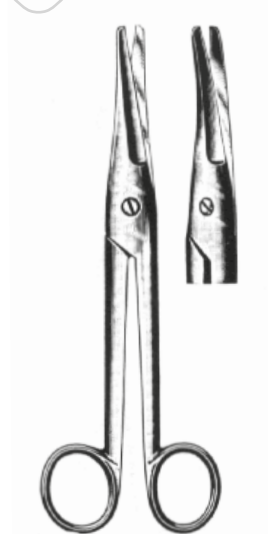
MAYO

09160-14	14,5 cm	09161-14
09164-14 TC	5 ³ / ₄ "	09165-14 TC
09160-17	17,0 cm	09161-17
09164-17 TC	6 ³ / ₄ "	09165-17 TC
09160-19	19,0 cm	09161-19
	7 ¹ / ₂ "	
09160-23	23,0 cm	09161-23
09164-23 TC	9"	09165-23 TC
09160-28	28,0 cm	09161-28
	11"	



MAYO-STILLE

09170-15	15,0 cm	09171-15
09174-15 TC	6"	09175-15 TC
09170-17	17,0 cm	09171-17
09174-17 TC	6 ³ / ₄ "	09175-17 TC
09170-21	21,0 cm	09171-21
09174-21 TC	8 ¹ / ₄ "	09175-21 TC

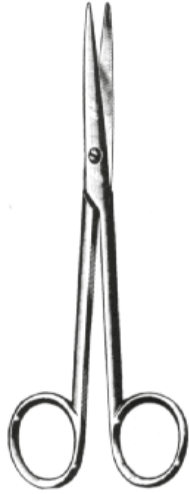


MAYO-NOBLE

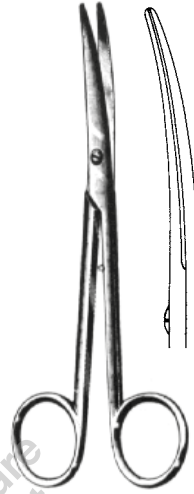
09180-17	17,0 cm	09181-17
	6 ³ / ₄ "	



Präparierscheren
Dissecting Scissors
Tijeras de disección
Forbici per dissezione



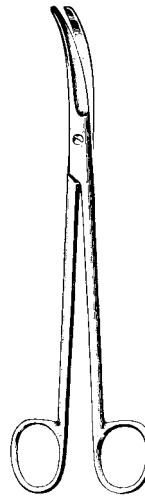
LEXER
09190-16
09194-16 TC
16 cm, 6 1/4"



LEXER
09191-16
09195-16 TC
16 cm, 6 1/4"



LEXER BABY
09202-10 09203-10
09206-10 TC 09207-10 TC
10 cm, 4"



JORGENSEN
09204-22
22 cm, 8 3/4"

Präparierscheren
Dissecting Scissors
Tijeras de disección
Forbici per dissezione



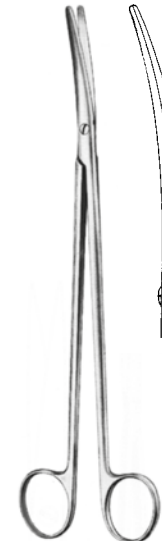
METZENBAUM	
09280-12	09284-12 TC
12 cm	4 3/4"
09280-15	09284-15 TC
15 cm	6"
09280-18	09284-18 TC
18 cm	7"
09280-20	09284-20 TC
20 cm	8"
09280-23	09284-23 TC
23 cm	9"
09280-25	09284-25 TC
25 cm	10"
09280-28	09284-28 TC
28 cm	11"
09280-30	09284-30 TC
30 cm	12"



METZENBAUM	
09281-12	09285-12 TC
12 cm	4 3/4"
09281-15	09285-15 TC
15 cm	6"
09281-18	09285-18 TC
18 cm	7"
09281-20	09285-20 TC
20 cm	8"
09281-23	09285-23 TC
23 cm	9"
09281-25	09285-25 TC
25 cm	10"
09281-28	09285-28 TC
28 cm	11"
09281-30	09285-30 TC
30 cm	12"



METZENBAUM FINO	
09282-15	09286-15 TC
15 cm	6"
09282-18	09286-18 TC
18 cm	7"
09282-20	09286-20 TC
20 cm	8"
09282-23	09286-23 TC
23 cm	9"
09282-25	09286-25 TC
25 cm	10"
09282-28	09286-28 TC
28 cm	11"



METZENBAUM FINO	
09283-15	09287-15 TC
15 cm	6"
09283-18	09287-18 TC
18 cm	7"
09283-20	09287-20 TC
20 cm	8"
09283-23	09287-23 TC
23 cm	9"
09283-25	09287-25 TC
25 cm	10"
09283-28	09287-28 TC
28 cm	11"

Präparierschere, Kapselschere
Dissecting Scissors, Capsula Scissor
Tijeras de disección, Tijera p. cápsula
Forbici per dissezione, Forbici per capsula



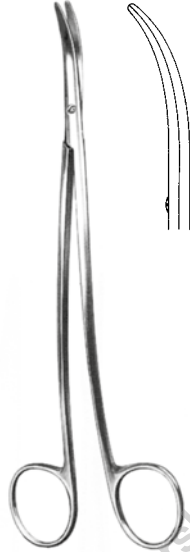
WELLER
09289-28
28 cm, 11"

Wondershare
PDFelement



RESANO
09290-25
25 cm, 10"

Präparierscheren, Ligaturscheren
 Dissecting Scissors, Ligature Scissors
 Tijeras de disección, Tijeras para ligaduras
 Forbici per dissezione, Forbici per legature



METZENBAUM "S"

09291-18 18 cm, 7" 09295-18 TC
 09291-20 20 cm, 8" 09295-20 TC
 09291-23 23 cm, 9" 09295-23 TC

Wellenschliff - wave cut



09296-15 TC
 14,5 cm 5 3/4"

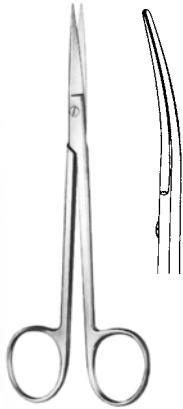


09296-18 TC
 18 cm 7"

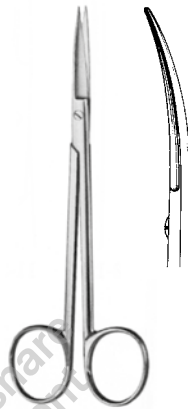


09296-23 TC
 23 cm 9"

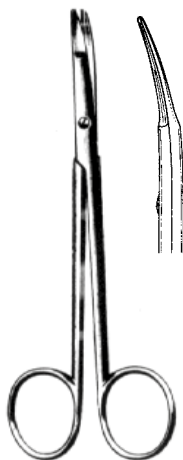
Präparierscheren
Dissecting Scissors
Tijeras de disección
Forbici per dissezione



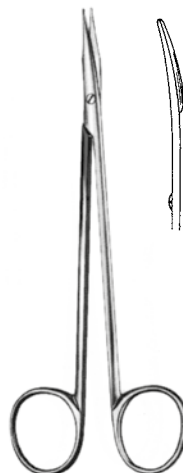
SANVENERO
09302-14 14 cm 09303-14
5 1/2"



JOSEPH
09304-14 14 cm 09305-14
5 1/2"

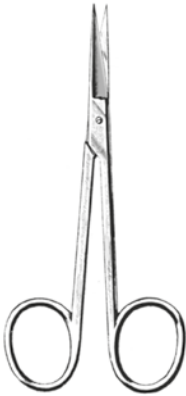


KILNER
09310-12 12 cm 09314-12 TC
09310-15 15 cm
09312-12 12 cm gerade/straight/recta/retta



REYNOLDS
09320-15 15 cm 09321-15
09321-18
09325-15 TC

Chirurgische Scheren, fein
 Operating Scissors, fine
 Tijeras para cirugía, finas
 Forbici per chirurgia, fine



IRIS



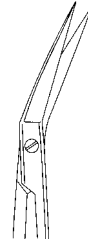
09340-09 9 cm
 09340-10 10 cm
 09340-11 11 cm
09344-11 TC

gerade
 straight
 rectas
 rette



09341-09
 09341-10
 09341-11
09345-11 TC

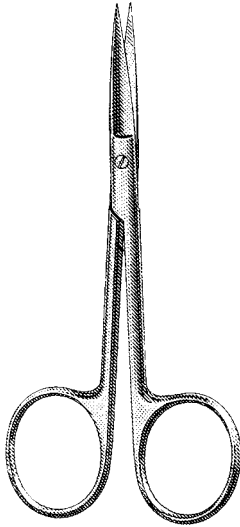
gebogen
 curved
 curvas
 curve



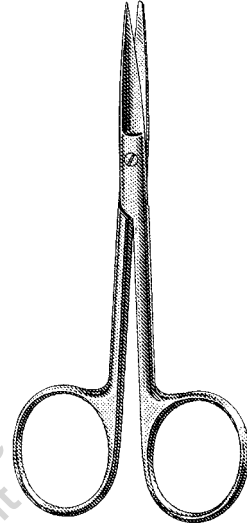
09346-11 11 cm

abgewinkelt
 angled
 angulada
 angolata

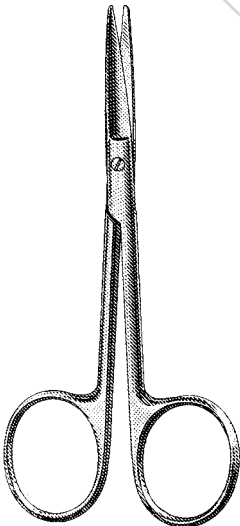
Chirurgische Scheren, Präparierscheren
 Operating Scissors, Dissecting Scissors
 Tijeras para cirugía, Tijeras de disección
 Forbici per chirurgia, Forbici per dissezione



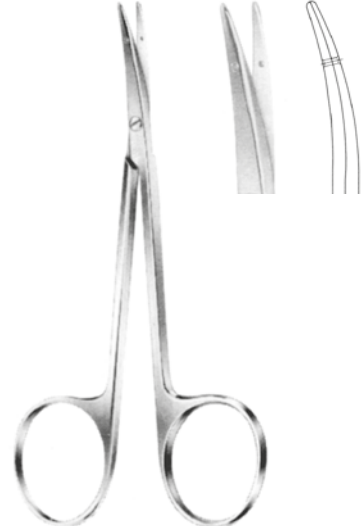
KNAPP
 10 cm, 4"
 09348-01 09348-02



KNAPP
 10 cm, 4"
 09348-03 09348-04

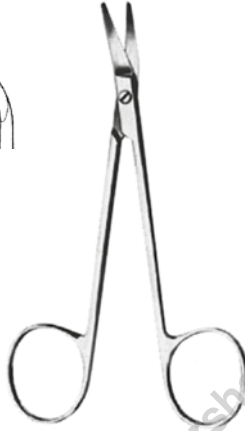
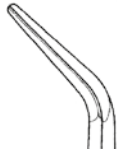


KNAPP
 10 cm, 4"
 09348-05 09348-06



LITTLER
 12 cm, 4 3/4"
 09349-12

Präparierscheren, feines Modell
Dissecting Scissors, fine pattern
Tijeras de disección, finas
Forbici per preparazione, modello fino

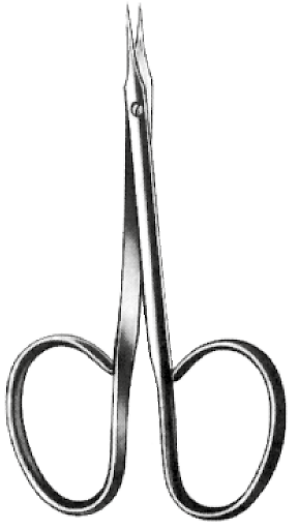


GRAEFE
09350-10
10 cm 4"

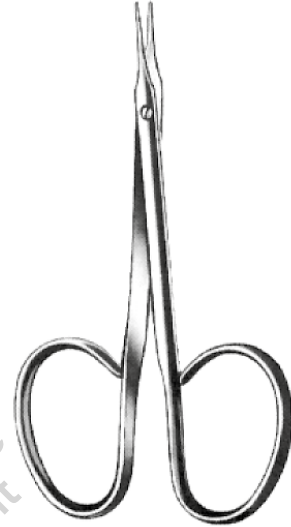


COTTLE
09358-11
11,5 cm 4 1/2"

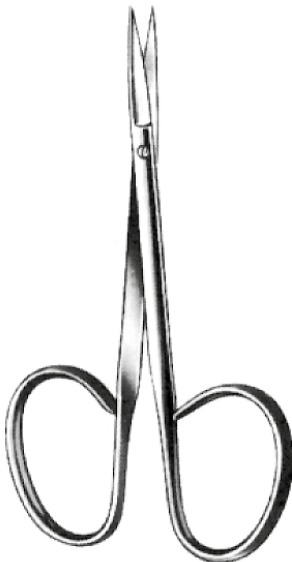
Präparierscheren, feines Modell
Dissecting Scissors, fine pattern
Tijeras de disección, finas
Forbici per preparazione, modello fino



GRADLE
09350-09 9,5 cm, 3³/₄" 09351-09



09352-09 9,5 cm, 3³/₄" 09353-09



09354-10 10 cm, 4" 09355-10

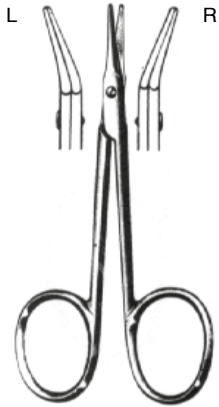


09356-10 10 cm, 4" 09357-10

Scheren
Scissors
Tijeras
Forbici

Sehnenscheren
Tendon Scissors
Tijeras para tendones
Forbici per tenotomia

Enucleationsschere
Enucleation Scissors
Tijera para enucleación
Forbici per enucleazione



09347-09 AEBLI 9 cm 09349-09
3 1/2"



STEVENS
11 cm
4 3/8"



09360-11 09361-11



09362-11 09363-11



LANDOLT
09381-11
12 cm, 4 3/4"

Nasenscheren - Nasal Scissors - Tijeras nasales - Forbici nasali



STRABISMUS
09370-11 09371-11
09374-11 TC 09375-11 TC
11 cm, 4 3/8"



HEYMANN
09401-18
18 cm, 7"

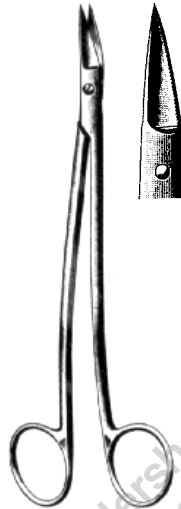


FOMON
09403-15
15 cm, 6"

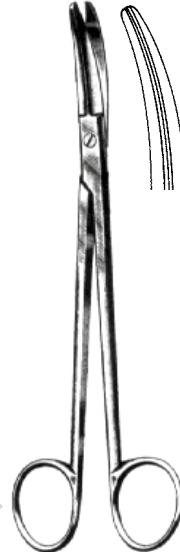
Tonsillen-, Gefäßscheren
Tonsil, Vascular Scissors
Tijeras amígdalas y vasculares
Forbici per tonsilli e vascolari



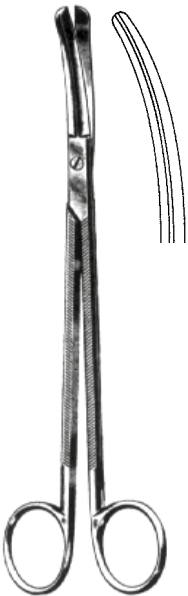
COTTLE
09405-16
09406-16 TC
16 cm, 6 1/4"



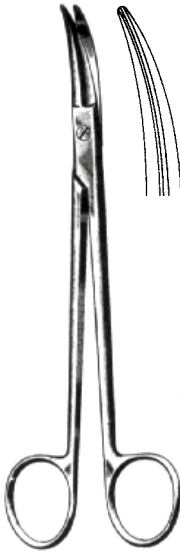
DEAN
09425-17 09427-17
17 cm, 6 3/4"



BOETTCHER
09435-18
18 cm, 7"



GOOD
09437-19
19 cm, 7 1/2"



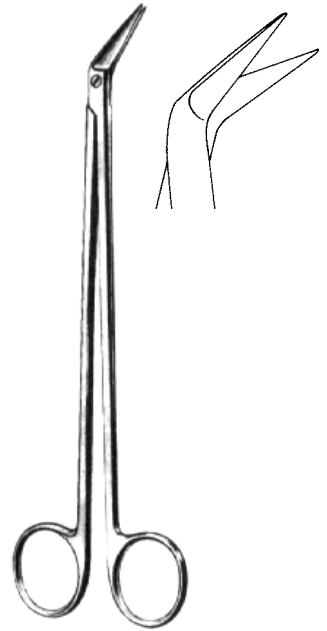
PRINCE
09439-17
17 cm, 6 3/4"



09468-15
15 cm, 6"



09470-11
11 cm, 4 3/8"



POTTS-DE MARTEL
09473-21
21 cm, 8 1/4"

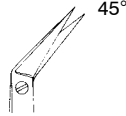
Scheren, Thorax und Gefäße
 Scissors, thorax and vascular
 Tijeras, torácicas y vasculares
 Forbici vascolari e toraciche



DIETRICH
 09475-25 – 09475-00
 17 cm, 6 3/4"



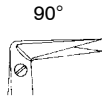
09475-25
09476-25 TC
 18 cm, 7"



09475-45
09476-45 TC
 18 cm, 7"



09475-60
09476-60 TC
 17,5 cm, 6.9"



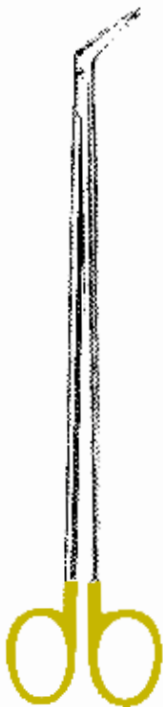
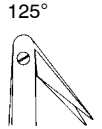
09475-90
09476-90 TC
 17 cm, 6 3/4"



09475-00
09476-00 TC
 17 cm, 6 3/4"



DIETRICH
 09477-01
 17 cm, 6 3/4"



DE BAKEY
 (POTTS-SMITH)



09478-25
 19 cm
 7 1/2"



09478-45
 19 cm
 7 1/2"



09478-60
 19 cm
 7 1/2"



09479-25
 23 cm
 9"



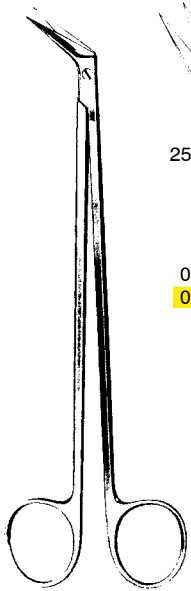
09479-45
 23 cm
 9"



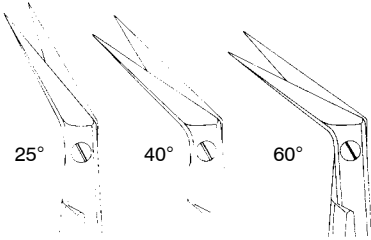
09479-60
 23 cm
 9"



Gefäßscheren
Vascular Scissors
Tijeras vasculares
Forbici vascolari



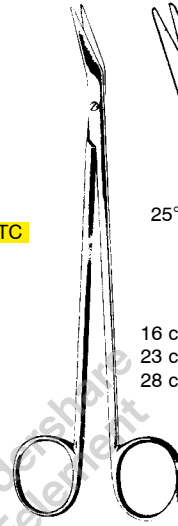
POTTS-SMITH
19 cm, 7 1/2"



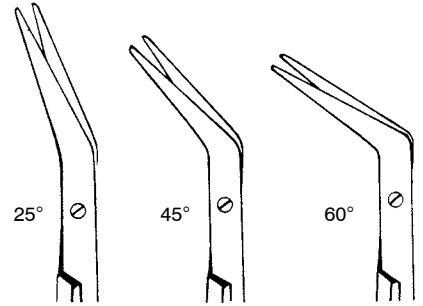
09480-25
09481-25 TC

09480-40
09481-40 TC

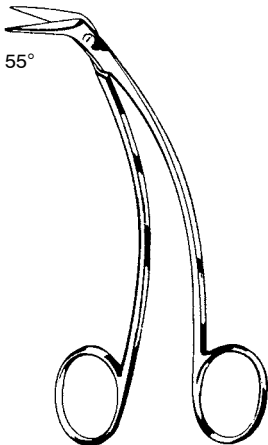
09480-60
09481-60 TC



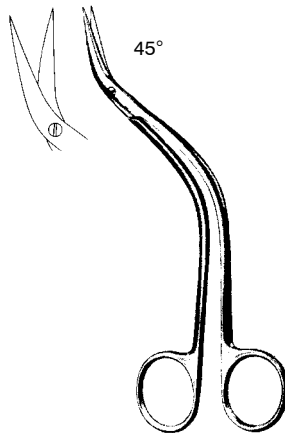
DE BAKEY



16 cm 09490-16 09491-16 09492-16
23 cm 09490-23 09491-23 09492-23
28 cm 09490-28 09491-28 09492-28



FAVALORO
09496-15 15 cm, 6"

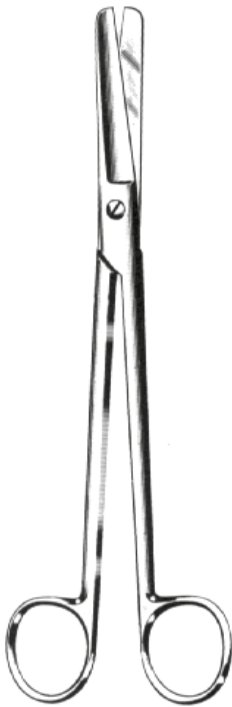


DE BAKEY
09497-15 15,5 cm, 6"



KELLY
09540-16 09541-16
09542-16 TC 09543-16 TC
16 cm, 6 1/4"

Gynäkologische Scheren
Gynecological Scissors
Tijeras ginecológicas
Forbici ginecologiche



SIMS

09510-20	20 cm, 8"	09511-20
09510-23	23 cm, 9"	09511-23
09516-23 TC	23 cm, 9"	09517-23 TC



09512-20
09512-23



09513-20
09513-23



09514-20
09514-23



09515-20
09515-23

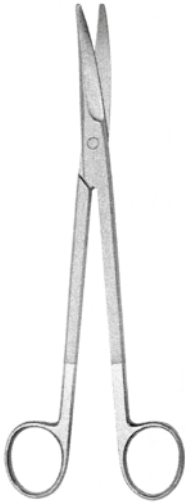


SIEBOLD

09523-24 24 cm, 9 1/2"

Gynäkologische Scheren
Gynecological Scissors
Tijeras ginecológicas
Forbici ginecologiche

Parametriumscheren - Parametrium scissors - Parametrium nasales - Parametrium nasali



HADEO



09501-23	23 cm, 9"	09501-22	22,5 cm, 8.9"
09505-23 TC	23 cm, 9"	09507-23 TC	23 cm, 9"
09505-26 TC	26 cm, 10 1/4"	09507-26 TC	26 cm, 10 1/4"
09505-30 TC	30 cm, 12"	09507-30 TC	30 cm, 12"



WERTHEIM

09525-22 22,5 cm, 8.9"



DOYEN

09530-17 09531-17
17,5 cm, 6.9"



DUBOIS

09536-27 09537-27
27 cm, 10 1/2"

Episiotomiescheren, Nabelschnurscheren
 Episiotomy Scissors, Umbilical Scissors
 Tijeras para episiotomía, Tijeras umbilicales
 Forbici per episiotomia, Forbici ombelicali

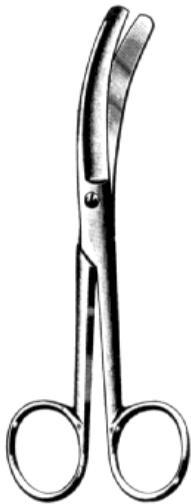


gezahnt
 saw edge
 dentadas
 dentellata

WALDMANN
 09548-18
 18 cm, 7"



U.S.A. Mod.
 09550-10
 10,5 cm, 4"



BUSCH
 09551-16
 16 cm, 6 1/4"

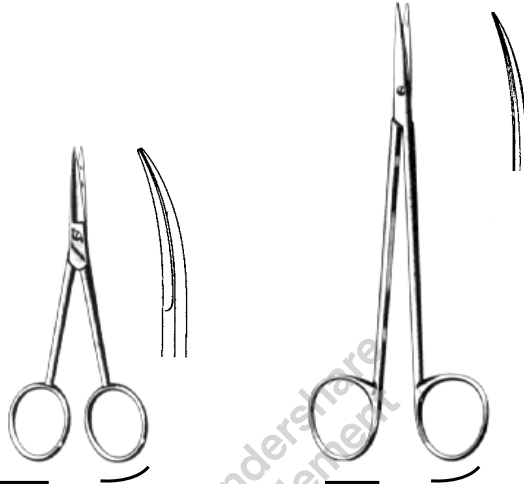


SCHUMACHER
 09553-16
 16 cm, 6 1/4"



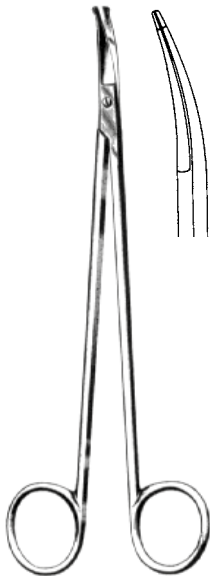
BRAUN-STADLER
 09560-14 14,5 cm, 5 3/4"
 09560-22 22,0 cm, 8 3/4"

Neurochirurgische Scheren, Gefäßschere, Präparierscheren
 Neurosurgical Scissors, Vascular Scissors, Dissecting Scissors
 Tijera para neurocirugía, Tijeras vasculares, Tijeras de disección
 Forbici per neurochirurgia, Forbici vascolari, Forbici per preparazione



09580-11 09581-11
11 cm, 4 3/8"

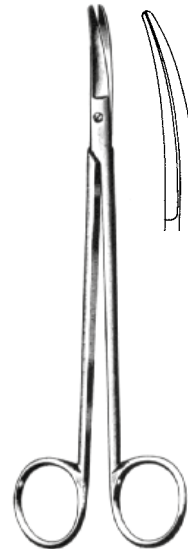
09582-15 09583-15
15 cm, 6"



STRULLY
09601-22
22 cm, 8 3/4"



TOENNIS-ADSON
09610-18
18 cm, 7"



TOENNIS-ADSON
09611-18
18 cm, 7"

Knorpelscheren, Nasenschere, Gefäßscheren
 Cartilage Scissors, Nasel Scissors, Vascular Scissors
 Tijeras para cartilago, Tijeras nasales, Tijeras vasculares
 Forbici per cartilagine, Forbici nasali, Forbici vascolari



gezahnt
 saw edge
 dentadas
 dentellata

MARTIN
 09613-20
 20 cm, 8"



McINDOE
 09614-19
 19 cm, 7 1/2"

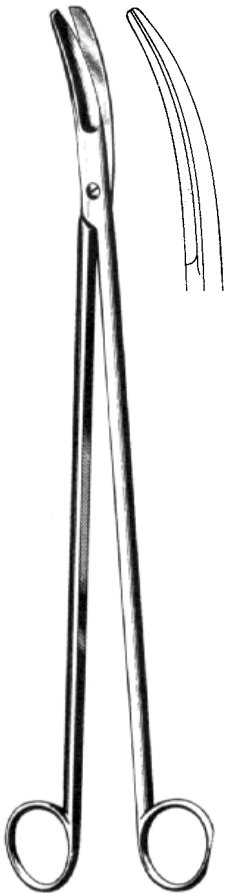


FOMON
 09617-13
 13 cm, 5 1/8"

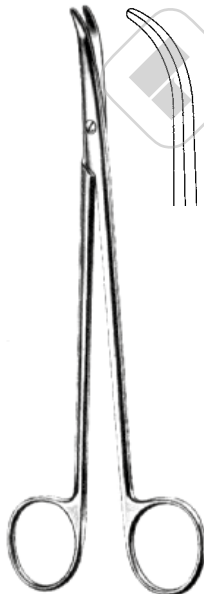


SCHMIEDEN-TAYLOR
 09619-17
 17 cm, 6 3/4"

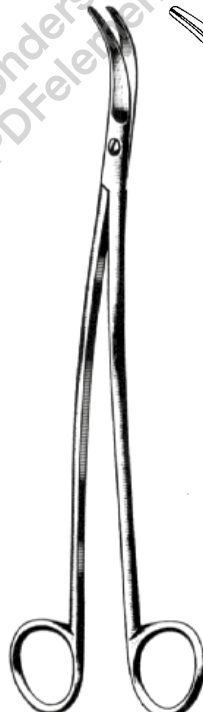
Gefäßscheren, Präparierscheren
Vascular Scissors, Dissecting Scissors
Tijeras vasculares, Tijeras de disección
Forbici vascolari, Forbici per preparazione



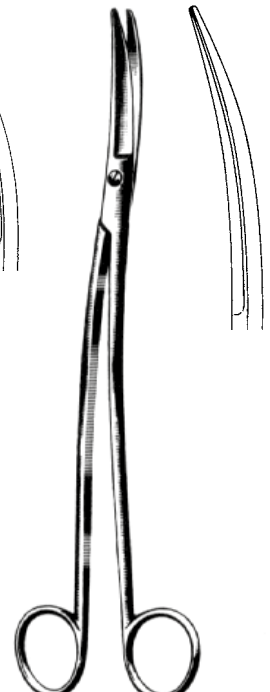
CRAFOORD
09641-30
30 cm, 11 ³/₄"



THOREK
09643-19 19 cm, 7 ¹/₂"
09643-25 25 cm, 10"



SATINSKY
09651-24
24,5 cm, 9 ¹/₂"



KLINKENBERGH-LOTH
09661-23
23 cm, 9"

Darmscheren, Nagelspaltschere, Fadenscheren
 Enterotomy Scissors, Nail Splitting Scissors, Stitch Scissors
 Tijeras para intestino, Tijeras para hender uña, Tijeras para hilos
 Forbici per enterotomia, Forbici per staccare unghie, Forbici per legature



FERGUSSON
 09770-18
 18 cm, 7"



09772-21
 21 cm, 8 1/4"



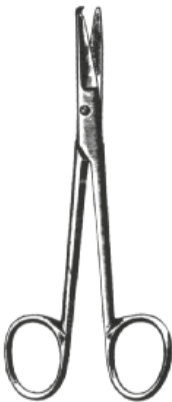
09774-21
 21 cm, 8 1/4"



— SYSTRUNK —
 09775-13 09777-13
 13 cm, 5 1/8"



SPENCER
 09802-09
 9 cm, 3 1/2"



SPENCER
 09802-11
 11 cm, 4 3/8"



NORTHBENT
 09803-09 9 cm, 3 1/2"
 09803-13 13 cm, 5 1/8"



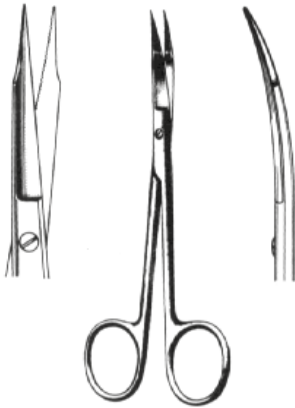
LITTAUER
 09804-14
 14 cm, 5 1/2"



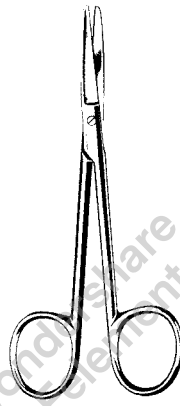
HEATH
 09809-15
 15 cm, 6"

Zahnfleischscheren, feine Scheren, Drahtschere
 Gum Scissors, Delicate Scissors, Wire Cutting Scissors
 Tijeras para encías, Tijeras finas, Tijeras para alambre
 Forbici per gengiva, Forbici delicate, Forbici per filo di metallo

1 Schneide gezahnt
 1 blade toothed
 1 hoja dentada
 1 taglio della lama dentellato



— GOLDMAN-FOX —
 09820-13 13 cm, 5 1/8" 09821-13



WAGNER
 12 cm, 4 3/4"

gerade
 straight
 rectas
 rette



Fig. 1
 09828-12



Fig. 2
 09826-12



Fig. 3
 09824-12

gebogen
 curved
 curvas
 curve



Fig. 1
 09823-12



Fig. 2
 09829-12



Fig. 3
 09825-12

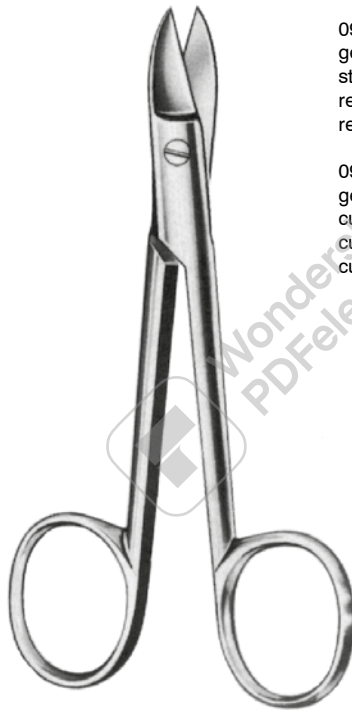


QUINBY
 09827-12 12 cm, 4 3/4"



UNIVERSAL
 09831-12 12 cm, 4 3/4"
 09835-12 TC 12 cm, 4 3/4"

Kronenscheren
Crown Scissors
Tijeras para coronas
Forbici per corona



09850-10
gerade spitz
straight pointed
rectas agudas
rette acute

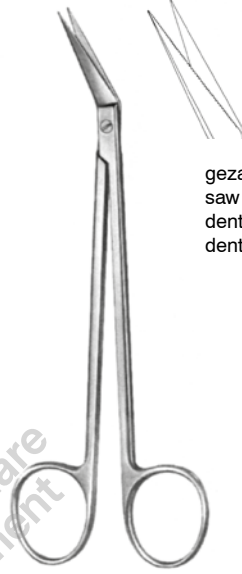
09851-10
gebogen spitz
curved pointed
curvas agudas
curve acute

BEEBEE
10,5 cm, 4"

Zahnfleissscheren
Gum Scissors
Tijeras para encias
Forbici per gengiva

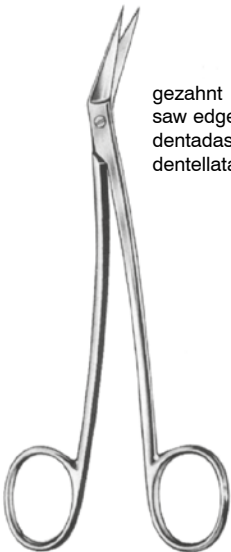


LA GRANGE
09854-11
11,5 cm, 4 1/2"



gezahnt
saw edge
dentadas
dentellata

LOCKLIN
09859-16
16 cm, 6 1/4"



gezahnt
saw edge
dentadas
dentellata

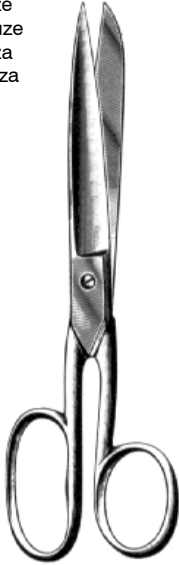
LOCKLIN
09860-16
16,5 cm, 6 1/2"



LOCKLIN
09861-16 TC
16,5 cm, 6 1/2"

Verbandscheren, Gipsschere
 Bandage Scissors, Plaster Scissors
 Tijeras para vendajes, Tijeras para yeso
 Forbici per bendaggi, Forbici per gesso

Gaze
 Gauze
 Gaza
 Garza



SMITH US ARMY
 09898-20
 20 cm, 8"



LISTER
 9 cm, 3 1/2"
 11 cm, 4 3/8"
 14 cm, 5 1/2"
 18 cm, 7"
 20 cm, 8"

09901-09
 09901-11
 09901-14
 09901-18
 09901-20

09905-14 TC
 09905-18 TC



LISTER
 09906-18 18 cm, 7"
 09906-20 20 cm, 8"



BERGMANN
 09911-23
 23 cm, 9"

Gippscheren, Verbandscheren
Plaster Scissors, Bandage Scissors
Tijeras para yeso, Tijeras para vendajes
Forbici per gesso, Forbici per bendaggi



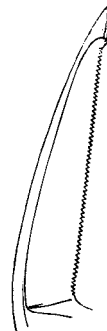
ESMARCH
09913-20 20 cm, 8"
09913-22 22 cm, 8 3/4"



SEUTIN
09915-23
23 cm, 9"



HADEO EXCENTER
09921-16 16 cm, 6 1/4"
09921-19 19 cm, 7 1/2"

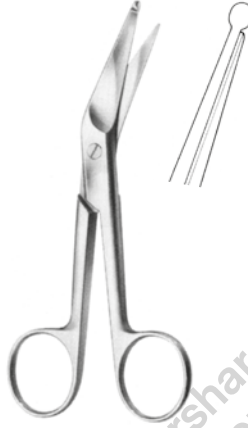


gezahnt
toothed
dentadas
dentellata

Verbandscheren, Gipsschere
 Bandage Scissors, Plaster Scissors
 Tijeras para vendajes, Tijeras para yeso
 Forbici per bendaggi, Forbici per gesso



KNOWLES
 09930-14
 14 cm, 5 1/2"



KNOWLES
 09931-14
 14 cm, 5 1/2"



LORENZ
 09933-23
 23 cm, 9"



BRUNS
 09935-23 23 cm, 9"
 09937-23 23 cm, 9"
 09939-23 TC



09941-20
 20 cm, 8"

in verschiedenen Farben lieferbar
 in different colours available
 en diferentes colores disponibles
 in differenti colori disponibile



UNIVERSAL
 09950-15 15 cm, 6"
 09950-18 18 cm, 7"

Supercut Scheren, gezahnt
 Supercut Scissors, saw edge
 Tijeras Supercut, dentadas
 Forbici Supercut, dentellate



09960-14 09961-14
 14,5 cm, 5 3/4"



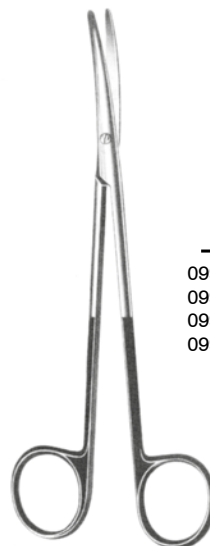
MAYO
 09962-14 14,5 cm 09963-14
 09962-17 17,0 cm 09963-17
 09962-23 23,0 cm 09963-23



MAYO-STILLE
 09964-15 15,0 cm 09965-15
 09964-17 17,0 cm 09965-17



BABY METZENBAUM
 09966-11 09967-11
 11,5 cm, 4 1/2"



METZENBAUM
 09970-14 14,5 cm 09971-14
 09970-18 18,0 cm 09971-18
 09970-20 20,0 cm 09971-20
 09970-23 23,0 cm 09971-23

Supercut Scheren, gezahnt
 Supercut Scissors, saw edge
 Tijeras Supercut, dentadas
 Forbici Supercut, dentellate



IRIS
 09980-11 09981-11
 11,5 cm, 4 1/2"



WAGNER
 09982-12 09983-12
 12 cm, 4 3/4"



STEVENS
 09984-11 09985-11
 11,5 cm, 4 1/2"



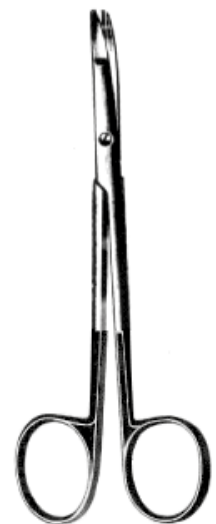
LaGrange
 09986-11 11,5 cm, 4 1/2"



LISTER
 09990-14 14,5 cm, 5 3/4"
 09990-18 18,0 cm, 7"

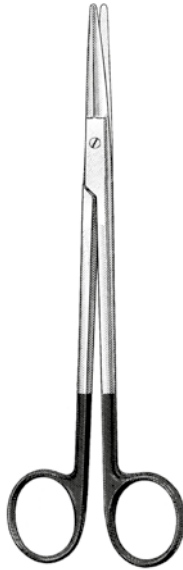


REYNOLDS
 09993-15 15 cm, 6"
 09993-18 18 cm, 7"



KILNER/RAGNELL
 09995-12 12 cm, 4 3/4"

Face-Lift-Scheren
Face-Lift-Scissors
Tijeras para Face-Lift
Forbici per Face-Lift



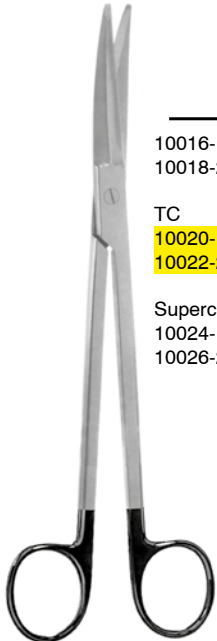
GORNEY
19 cm, 7 1/2"



10010-19
10012-19 TC
10014-19 Supercut

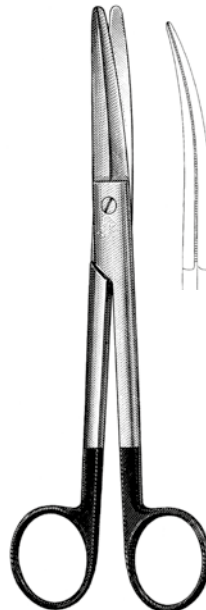


10011-19
10013-19 TC
10015-19 Supercut



REES

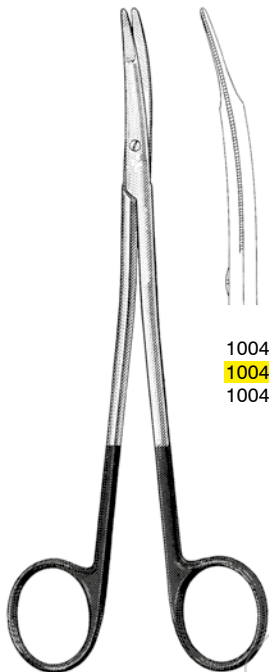
10016-17	17,0 cm, 6 3/4"	10017-17
10018-20	20,5 cm, 8"	10019-20
TC		
10020-17	17,0 cm, 6 3/4"	10021-17
10022-20	20,5 cm, 8"	10023-20
Supercut		
10024-17	17,0 cm, 6 3/4"	10025-17
10026-20	20,5 cm, 8"	10027-20



KAYE

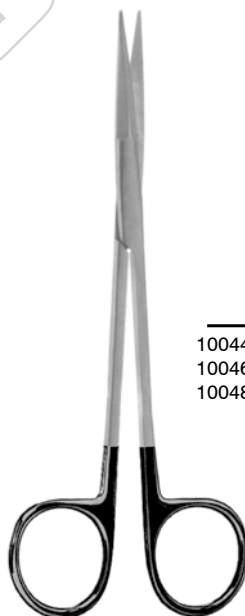
TC		
10028-14	14,5 cm, 5 3/4"	10029-14
10030-18	18,5 cm, 7 1/4"	10031-18
10032-23	23,0 cm, 9"	10033-23
Supercut		
10034-14	14,5 cm, 5 3/4"	10035-14
10036-18	18,5 cm, 7 1/4"	10037-18
10038-23	23,0 cm, 9"	10039-23

Face-Lift-Scheren
Face-Lift-Scissors
Tijeras para Face-Lift
Forbici per Face-Lift



10040-18
10041-18 TC
10042-18 Supercut

FREEMAN
18 cm, 7"



10044-14
10046-14 TC
10048-14 Supercut

10045-14
10047-14 TC
10049-14 Supercut

PECK JOSEPH
14,5 cm, 5 3/4"

Augenscheren
Ophthalmic Scissors
Tijeras oculares
Forbici oculistiche



spitz
pointed
agudas
acute

WESTCOTT
10102-11
11 cm, 4 3/8"



stumpf
blunt
romas
smusse

WESTCOTT
10104-11
11 cm, 4 3/8"



spitz
pointed
agudas
acute

NOYES
10110-12 10111-12
12 cm, 4 3/4"



WECKER
11 cm, 4 3/8"



10113-11

spitz
pointed
agudas
acute



10115-11

spitz / stumpf
pointed / blunt
agudas / romas
acute / smusse



10117-11

stumpf
blunt
romas
smusse



BARRAQUER
10119-10 5,5 cm, 2.2"
(Colibri)

Mikro-Scheren
Micro-Scissors
Micro-Tijeras
Micro-Forbici



10120-16
10120-18
10120-22

16,0 cm, 6 1/4"
18,5 cm, 7 1/4"
22,5 cm, 8.9"



10121-16
10121-18
10121-22



10122-16
10122-18
10122-22

16,0 cm, 6 1/4"
18,5 cm, 7 1/4"
22,5 cm, 8.9"



10123-16
10123-18
10123-22



10124-16
10124-18
10124-22

16,0 cm, 6 1/4"
18,5 cm, 7 1/4"
22,5 cm, 8.9"



10125-16
10125-18
10125-22

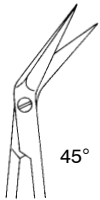
Circumflex

Mikro-Scheren
Micro-Scissors
Micro-Tijeras
Micro-Forbici



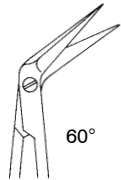
25°

10126-25



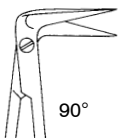
45°

10126-45



60°

10126-60



90°

10126-90



125°

10126-00



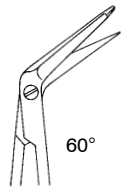
25°

10127-25



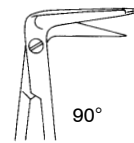
45°

10127-45



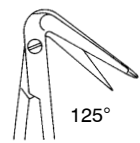
60°

10127-60



90°

10127-90



125°

10127-00



HADEO
18 cm, 7"

Mikro-Scheren
Micro-Scissors
Micro-Tijeras
Micro-Forbici



10128-09
9 cm, 3 1/2"



10128-15
gerade
straight
rectas
rette

10129-15
gebogen
curved
curvas
curvo

10130-15
gebogen, 1 Schneide gezahnt
curved, 1 blade toothed
curvas, 1 hoja dentada
curva, 1 lama dentellata

10128-15 - 10130-15
15 cm, 6"

halbscharf
semi-sharp
medio roma
lame semi smusse



HEPP-SCHEIDEL
10131-14 14 cm, 5 1/2"
10131-18 18 cm, 7"



HEPP-SCHEIDEL
10132-18
18 cm, 7"

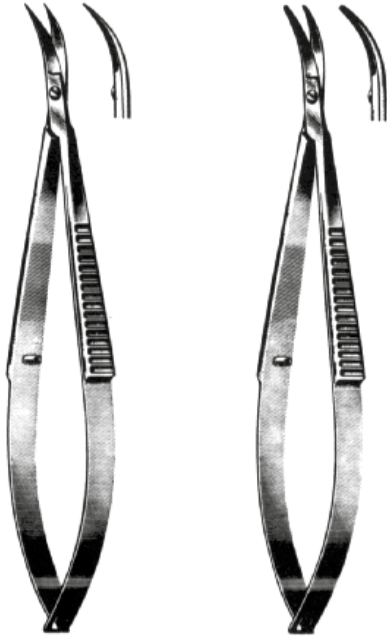


HEPP-SCHEIDEL
10137-01
18 cm, 7"
spitz
pointed
agudas
acute

HEPP-SCHEIDEL
10137-02
18 cm, 7"
stumpf
blunt
romas
smusse

Augen-, Mikroscheren
Ophthalmic, Micro Scissors
Tijeras oculares, micro tijeras
Forbici oculistiche, micro chirurg.

Iridektomie, Iridectomy, Iridectomía, iridectomia



CASTROVIEJO
10133-10 10 cm, 4"

CASTROVIEJO
10135-10 10 cm, 4"



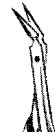
VANNAS
10140-08 8 cm, 3 1/8"



VANNAS
10141-08 8 cm, 3 1/8"



10142-08
kniegebogen
angular
acodada
angolate



10143-08
aufgewinkelt
angled up
acodada hacia arriba
angolate verso l'alto

Hornhautscheren, Corneal scissors, Tijeras corneales, Forbici corneali



CASTROVIEJO
10151-11 11 cm, 4 3/8"



CASTROVIEJO
10153-11 11 cm, 4 3/8"



CASTROVIEJO
10155-11 11 cm, 4 3/8"

Mikro-Scheren
Micro-Scissors
Micro-Tijeras
Micro-Forbici



HADEO
10202-18 - 10203-18
18 cm, 7"



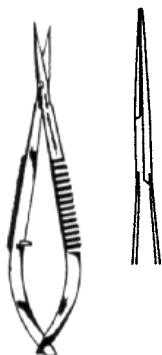
10313-14
14 cm
5 1/2"



10313-16
16 cm
6 1/4"



GOMEL



HADEO micro
10320-09
9 cm, 3 1/2"



HADEO
10330-19 - 10333-19
18,5 cm, 7 1/4"



10330-19



10331-19



10333-19



Wondershare
PDFElement

Anatomische und chirurgische Pinzetten
Dressing and Tissue Forceps
Pinzas de disección, sin/con dientes
Pinze per dissezione, chirurgiche/anatomiche

STANDARD



USA

STILLE

cm				
10,5	4 1/4"	11102-10		
11,5	4 1/2"	11102-11		
12,0	4 3/4"			11104-12
13,0	5 1/8"	11102-13		11104-13
14,5	5 3/4"	11102-14	11103-14	11104-14
15,0	6"			11104-15
16,0	6 1/4"	11102-16		
18,0	7"	11102-18		11104-18
20,0	8"	11102-20		
21,0	8 1/4"			11104-21
25,0	10"	11102-25		11104-25
30,0	12"	11102-30		

schmal
narrow
estrecha
stretta











POTTS-SMITH

POTTS-SMITH
1x2

cm					
11,5	4 1/2"	11110-11			
13,0	5 1/8"	11110-13			
14,5	5 3/4"	11110-14	11114-14 TC		
16,0	6 1/4"	11110-16	11114-16 TC		
18,0	7"	11110-18		11112-18	11116-18 TC
20,0	8"	11110-20	11114-20 TC		11126-18
21,0	8 1/4"			11112-21	11116-21 TC
25,0	10"	11110-25	11114-25 TC	11112-25	11116-25 TC
30,0	12"	11110-30			11126-25

Chirurgische Pinzetten
Tissue Forceps
Pinzas de disección, con dientes
Pinze per dissezione, chirurgiche

	STANDARD	USA	STILLE	schmal narrow estrecha stretta
	 1x2	 1x2	 1x2	 1x2
cm				
10,5	4 1/4" 11120-10			
11,5	4 1/2" 11120-11			11130-11
12,0	4 3/4" 11120-12	11122-12		
13,0	5 1/8" 11120-13	11122-13		11130-13
14,5	5 3/4" 11120-14	11122-14		11130-14
15,0	6" 11120-15		11124-15	
15,5	6" 11120-16	11122-15		
16,0	6 1/4" 11120-16			11130-16
18,0	7" 11120-18	11122-18		11130-18
20,0	8" 11120-20			11130-20
21,0	8 1/4" 11120-21	11122-21		
25,0	10" 11120-25	11122-25		
30,0	12" 11120-30			
	 1x2	 2x3	 3x4	 4x5
cm	OEHLER			
11,5	4 1/2" 11132-16 TC	11140-11		
13,0	5 1/8" 11132-18 TC	11140-13	11150-13	11160-13
14,5	5 3/4" 11132-20 TC	11140-14	11150-14	11160-14
16,0	6 1/4" 11132-25 TC	11140-16	11150-16	11160-16
18,0	7" 11132-30 TC	11140-18		
20,0	8" 11132-25 TC	11140-20		
25,0	10" 11132-25 TC	11140-25		
30,0	12" 11132-30 TC			

Anatomische und chirurgische Pinzetten
Dressing and Tissue Forceps
Pinzas de disección, sin/con dientes
Pinze per dissezione, chirurgice/anatomiche



ADSON
11170-12 12,0 cm, 4 3/4"
11170-15 15,0 cm, 6"



ADSON
11174-12 TC 12,0 cm, 4 3/4"
11174-15 TC 15,0 cm, 6"



ADSON micro
11176-12 12,0 cm, 4 3/4"
11176-15 15,0 cm, 6"



ADSON-DEBAKEY atraumatic
11177-12
12,0 cm, 4 3/4"



ADSON
11178-12
12,0 cm, 4 3/4"



ADSON
11179-12
12 cm, 4 3/4"

Anatomische und chirurgische Pinzetten
Dressing and Tissue Forceps
Pinzas de disección, sin/con dientes
Pinze per dissezione, anatomiche/chirurgiche



1x2

ADSON

11180-12 12,0 cm, 4 3/4"
11180-15 15,0 cm, 6"



1x2

ADSON

11181-12 TC 12,0 cm, 4 3/4"
11181-15 TC 15,0 cm, 6"



1x2

ADSON micro

11186-12 12,0 cm, 4 3/4"
11186-15 15,0 cm, 6"



1x2

ADSON

11187-12
12 cm, 4 3/4"



7x7

ADSON-BROWN

11188-12 12,0 cm, 4 3/4"
11188-15 15,0 cm, 6"
11189-12 TC 12,0 cm, 4 3/4"

Anatomische und chirurgische Pinzetten
Dressing and Tissue Forceps
Pinzas de disección, sin/con dientes
Pinze per dissezione, chirurgice/anatomiche



9x9

BROWN
11189-15 15,0 cm, 6"
11189-20 20,0 cm, 8"
11189-25 25,0 cm, 10"



GRAEFE
11190-10 10,5 cm, 4.1"



WAUGH
11187-18 18 cm, 7"
11187-20 20 cm, 8"
11187-25 25 cm, 10"
11187-30 30 cm, 11 3/4"



CUSHING
11220-17
11224-17 TC
17,0 cm, 6 3/4"

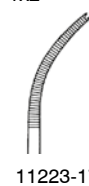


11221-17



CUSHING
11222-17
11225-17 TC
17,0 cm, 6 3/4"

1x2



11223-17



LERCHE
11232-15
15,0 cm, 6"

5x6



Anatomische und chirurgische Pinzetten, Faßpinzetten
 Dressing and Tissue Forceps
 Pinzas de disección, sin/con dientes
 Pinze per dissezione, chirurgiche/anatomiche



BROPHY
 11231-20
 20,0 cm, 8"



BROPHY
 11233-20
 20,0 cm, 8"



BROPHY
 20,0 cm, 8"



11235-20



ADLERKREUTZ
 11236-15 15,0 cm, 6"
 11236-20 20,0 cm, 8"



DUEHRSEN
 11237-20
 20 cm, 8"



LANE
 11240-14
 14,5 cm, 5 3/4"

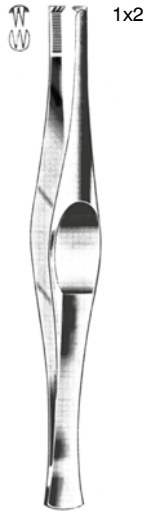


LANE
 11242-14
 14,5 cm, 5 3/4"

Anatomische und chirurgische Pinzetten, Faßpinzetten
 Dressing and Tissue Forceps
 Pinzas de disección, sin/con dientes
 Pinze per dissezione, chirurgiche/anatomiche



FERRIS-SMITH
 11246-18
 18,0 cm, 7"



FERRIS-SMITH
 11248-18
 18,0 cm, 7"



DUVAL
 11250-14
 14,5 cm, 5 3/4"



COLLIN-DUVAL
 11252-20
 20,0 cm, 8"



Russ. Mod.
 11256-15 15,0 cm, 6"
 11256-20 20,0 cm, 8"
 11256-25 25,0 cm, 10"



McINDOE
 11257-15
 15,0 cm, 6"



McINDOE
 11258-15 15,0 cm, 6"
 11259-15 TC 15,0 cm, 6"

Anatomische und chirurgische Pinzetten
 Dressing and Tissue Forceps
 Pinzas de disección, sin/con dientes
 Pinze per dissezione, chirurgiche/anatomiche



SEMKEN

11260-12	12,5 cm, 5"
11260-15	15,5 cm, 6"
11261-15 TC	15,5 cm, 6"



1x2

SEMKEN

11270-12	12,5 cm, 5"
11270-15	15,5 cm, 6"
11271-15 TC	15,5 cm, 6"
11271-18 TC	18 cm, 7"



1x2

GILLIES

11272-15	15,5 cm, 6"
11273-15 TC	15,5 cm, 6"



15,5 cm, 6"

11274-06
0,6 mm11274-08
0,8 mm11274-10
1,0 mm

GERALD

11302-17	17,5 cm, 6.9"
11302-23	23,0 cm, 9"
11304-17 TC	17,0 cm, 6 3/4"



GERALD

11303-17	17,5 cm, 6.9"
----------	---------------

Anatomische und chirurgische Pinzetten
 Dressing and Tissue Forceps
 Pinzas de disección, sin/con dientes
 Pinze per dissezione, chirurgiche/anatomiche



GERALD
 11305-17
 17,5 cm, 6.9"



GERALD
 11310-17 17,5 cm, 6.9"
 11312-17 TC 17,5 cm, 6.9"



GERALD
 11311-17
 17,5 cm, 6.9"



CUSHING-TAYLOR
 11312-18 TC
 18,5 cm, 7 1/4"



GERALD
 11313-17
 17,5 cm, 6.9"



TAYLOR
 17 cm, 6 3/4"

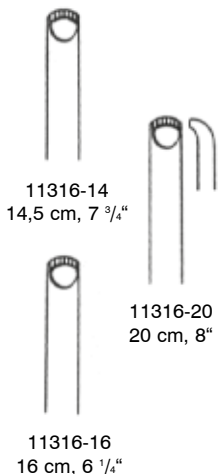


TAYLOR
 17 cm, 6 3/4"

Anatomische und chirurgische Pinzetten
 Dressing and Tissue Forceps
 Pinzas de disección, sin/con dientes
 Pinze per dissezione, chirurgiche/anatomiche



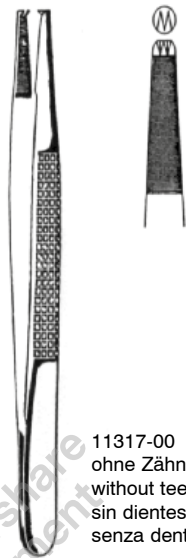
DURANTE



11316-14
14,5 cm, 7 3/4"

11316-16
16 cm, 6 1/4"

11316-20
20 cm, 8"



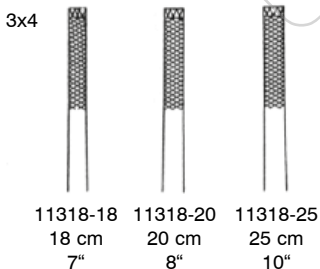
BONNEY
18 cm, 7"

11317-00
ohne Zähne
without teeth
sin dientes
senza denti

- 11317-12 1x2
- 11317-23 2x3
- 11319-12 TC 1x2



STILLE-BARRAYA



11318-18
18 cm
7"

11318-20
20 cm
8"

11318-25
25 cm
10"



OCHSNER
11319-14 14,5 cm 5 3/4"



SINGLEY
11320-18 18 cm 7"
11320-23 23 cm 9"

Anatomische und chirurgische Pinzetten
 Dressing and Tissue Forceps
 Pinzas de disección, sin/con dientes
 Pinze per dissezione, chirurgice/anatomiche



NELSON
 11322-15 15 cm 6"
 11322-18 18 cm 7"
 11322-23 23 cm 9"



WANGENSTEEN
 11324-23
 23 cm 9"



11325-15 TC
 15 cm, 6"

11325-23 TC
 23 cm, 9"

11325-25 TC
 25 cm, 10"

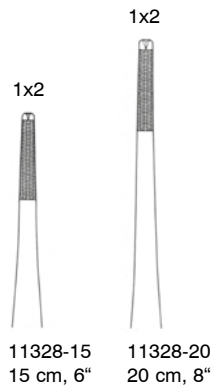
WANGENSTEEN



MAYO
 11326-23 23 cm, 9"



**STRASSBURGER
 MODELL**



1x2
 11328-15
 15 cm, 6"

1x2
 11328-20
 20 cm, 8"

Uhrmacherpinzetten
Jeweler Type Forceps
Pinzas de relojero
Pinze da orologiaio

Fig. 1



11401-01
12 cm, 4 ³/₄"

Fig. 3



11403-03
12 cm, 4 ³/₄"

Fig. 3c



11403-04
11 cm, 4 ³/₈"

Fig. 4



11404-04
11 cm, 4 ³/₈"

Fig. 5



11405-05
11 cm, 4 ³/₈"

Fig. 7



11407-07
12 cm, 4 ³/₄"

Splitterpinzetten
Splinter Forceps
Pinzas para espinas
Pinze per schegge



11802-09 9,0 cm, 3 1/2"
11802-10 10,5 cm, 4.1"
11802-11 11,5 cm, 4 1/2"



FEILCHENFELD
11810-07 7,5 cm, 3"
11810-09 9,0 cm, 3 1/2"
11810-11 11,5 cm, 4 1/2"



HUNTER
11812-10 10,5 cm, 4.1"



HUNTER
11813-10
10,5 cm, 4.1"



HUNTER
11815-12
12,5 cm, 5"



CARMALT
11816-10
10,5 cm, 4.1"

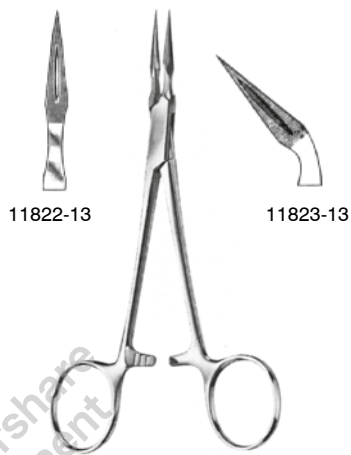


CARMALT
11817-10
10,5 cm, 4.1"

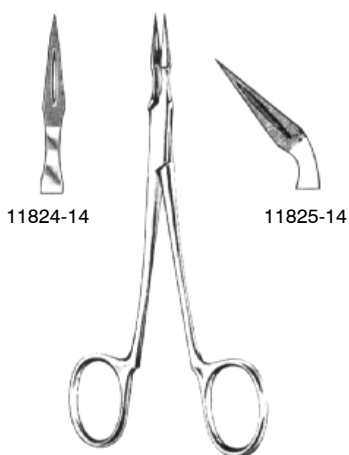
Splitterzangen
Splinter Forceps
Pinzas para espinas
Pinze per schegge



PEET
11821-11
11,5 cm, 4 1/2"



STIEGLITZ
11822-13
13,5 cm, 5 1/4"

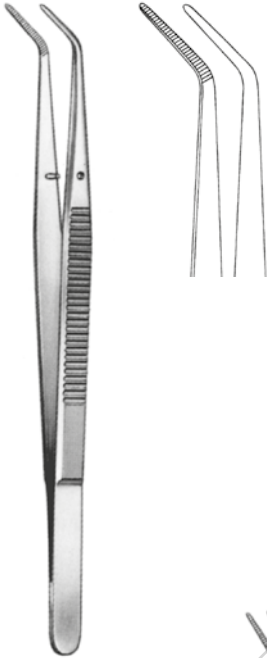


ARCHER
11824-14
14 cm, 5 1/2"

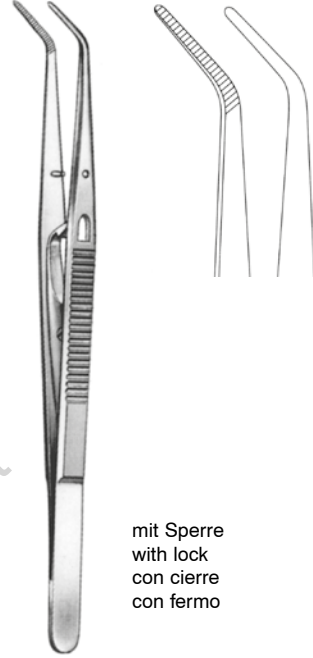


VIRTUS (RALK)
11828-15
15 cm, 6"

Zahnpinzetten
Dental Forceps
Pinzas dentales
Pinze dentali



LONDON-COLLEGE
11900-01
15 cm, 6"



LONDON-COLLEGE
11901-05
15 cm, 6"

mit Sperre
with lock
con cierre
con fermo

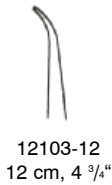


MERIAM
11910-01
15 cm, 6"

Mikrochirurgie-Pinzetten
Microsurgery Forceps
Pinzas para microcirugía
Pinze per microchirurgia



12102-12
12 cm, 4 3/4"



12103-12
12 cm, 4 3/4"



12104-15
15 cm, 6"



12105-15
15 cm, 6"



12108-18
18 cm, 7"

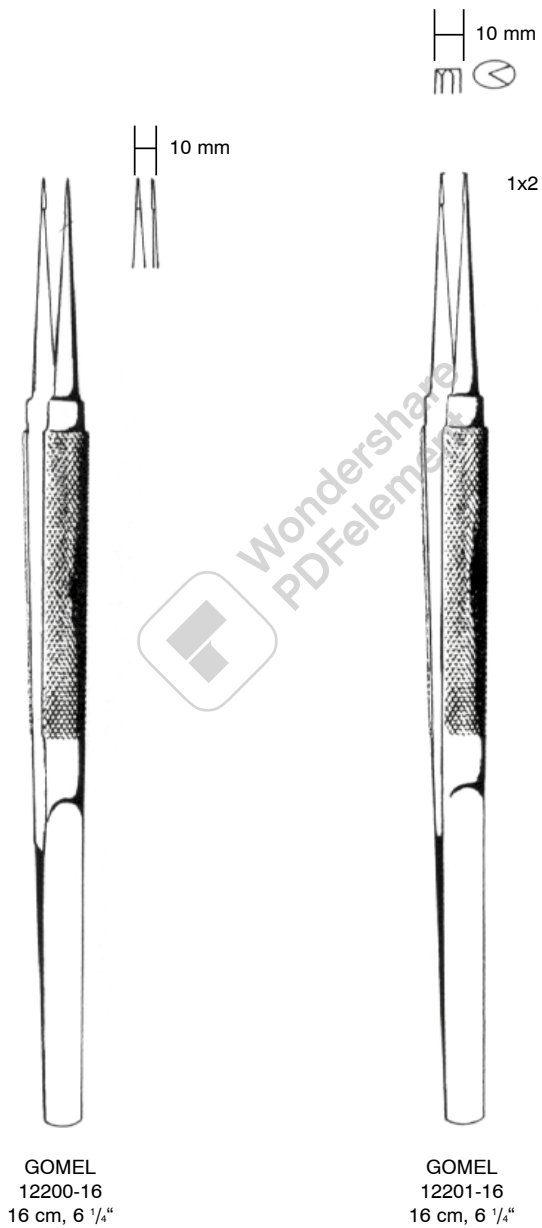


12109-18
18 cm, 7"

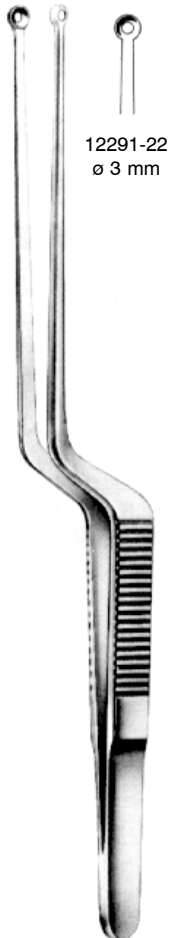
Ultra-Light-Pinzetten
Ultra-Light-Forceps
Pinzas-Ultra-Ligera
Pinza-ultra-leggera



Mikrochirurgie-Pinzetten
 Microsurgery Forceps
 Pinzas para microcirugía
 Pinze per microchirurgia



Tumorpinzetten
Tumor forceps
Pinzas para tumores
Pinze per tumori



12291-22
ø 3 mm



12293-22
ø 5 mm



YASARGIL
12295-22
ø 3 mm



HUNT
12297-22
ø 5 mm

YASARGIL
22 cm, 8 ³/₄"

22 cm, 8 ³/₄"

Atraumatische Pinzetten
Atraumatic Tissue Forceps
Pinzas atraumáticas
Pinze atraumatiche



1 mm

DE BAKEY

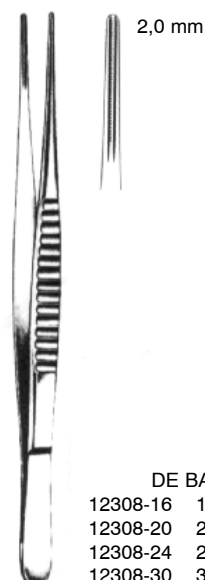
12302-16 16 cm, 6 1/4"
12302-20 20 cm, 8"
12302-24 24 cm, 9 1/2"



1,5 mm

DE BAKEY

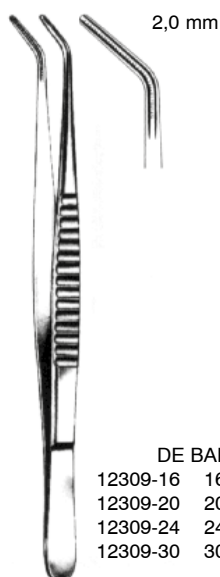
12306-16 16 cm, 6 1/4"
12306-20 20 cm, 8"
12306-24 24 cm, 9 1/2"
12306-30 30 cm, 11 3/4"



2,0 mm

DE BAKEY

12308-16 16 cm, 6 1/4"
12308-20 20 cm, 8"
12308-24 24 cm, 9 1/2"
12308-30 30 cm, 11 3/4"



2,0 mm

DE BAKEY

12309-16 16 cm, 6 1/4"
12309-20 20 cm, 8"
12309-24 24 cm, 9 1/2"
12309-30 30 cm, 11 3/4"



2,7 mm

DE BAKEY

12304-16 16 cm, 6 1/4"
12304-20 20 cm, 8"
12304-24 24 cm, 9 1/2"
12304-30 30 cm, 11 3/4"

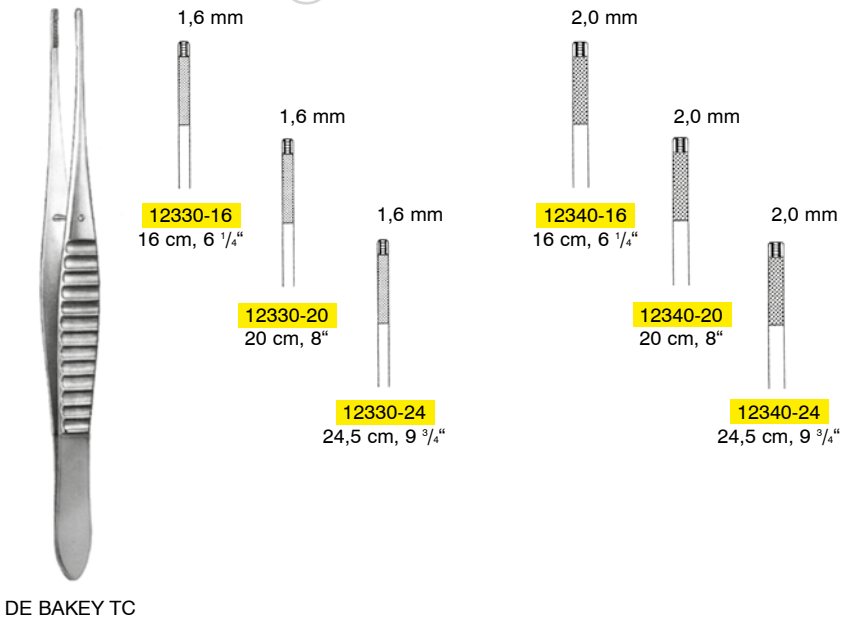
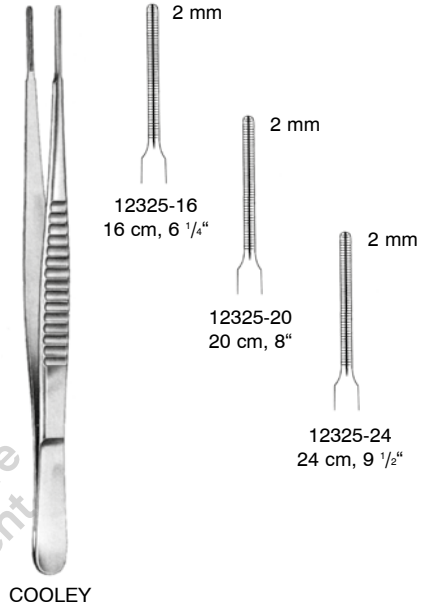
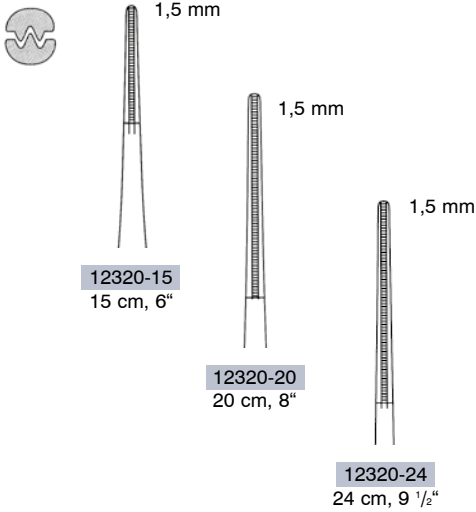


3,5 mm

DE BAKEY

12310-16 16 cm, 6 1/4"
12310-20 20 cm, 8"
12310-24 24 cm, 9 1/2"
12310-30 30 cm, 11 3/4"

Atraumatische Pinzetten
 Atraumatic Tissue Forceps
 Pinzas atraumáticas
 Pinze atraumatiche



Atrauma-Bulldogklemmen
 Atrauma-Bulldog Clamps
 Clamps Atrauma Bulldog
 Pinze Atrauma Bulldog



13090-40
 40 mm / 1 1/2"

13090-45
 45 mm / 1 3/4"

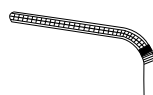
13090-50
 50 mm / 2"



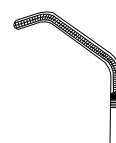
13091-40
 40 mm / 1 1/2"

13091-45
 45 mm / 1 3/4"

13091-50
 50 mm / 2"

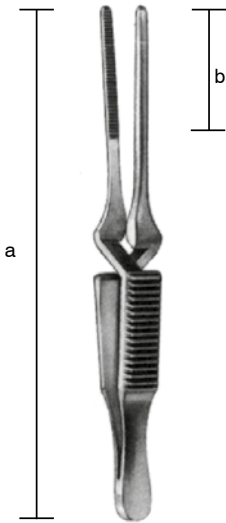


GLOVER
 13098-06
 57 mm / 2 3/8"

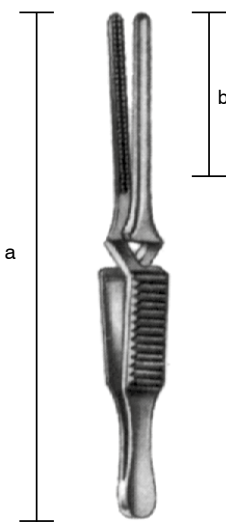
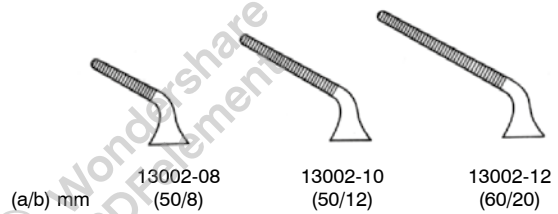
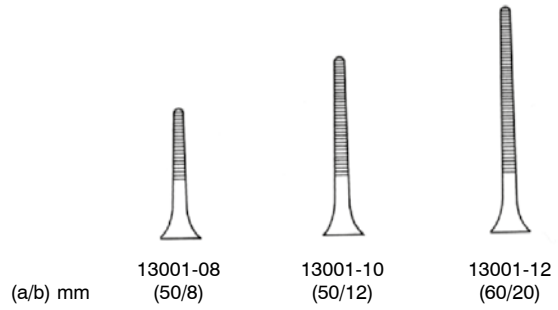


DE BAKEY
 13099-07
 73 mm / 2 3/4"

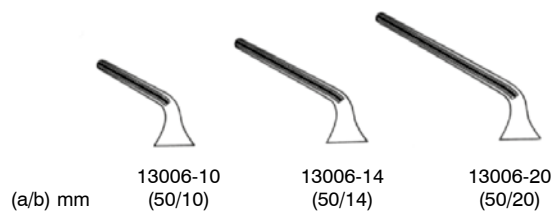
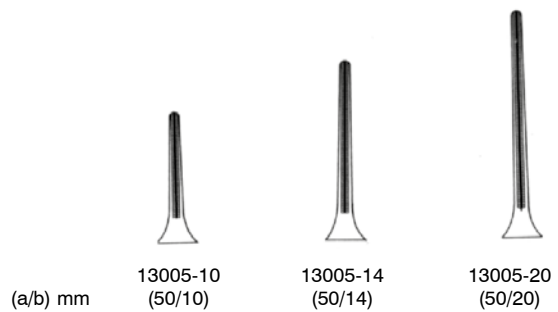
Mini-Bulldogklemmen
Mini Bulldog Clamps
Clamps Bulldog Mini
Pinze Bulldog Mini



DIETHRICH



DEBAKEY-DIETHRICH



Titan-Atrauma-Bulldogklemmen
 Titanium Atrauma Bulldog Clamps
 Titan Clamp Bulldog
 Titan Pinze Bulldog

	3 cm, 1.2"	3,5 cm, 1.4"	4 cm, 1 1/2"	5 cm, 2"
Vene	13010-30	13010-35	13010-40	13010-50
Arterie	13011-30	13011-35	13011-40	13011-50

	3 cm, 1.2"	3,5 cm, 1.4"	4 cm, 1 1/2"	5 cm, 2"
Vena	13012-30	13012-35	13012-40	13012-50
Arteria	13013-30	13013-35	13013-40	13013-50

	3 cm, 1.2"	3,5 cm, 1.4"	4 cm, 1 1/2"	5 cm, 2"
Vene	13014-30	13014-35	13014-40	13014-50
Arterie	13015-30	13015-35	13015-40	13015-50

Atrauma-Bulldogklemmen
Atrauma Bulldog Clamps
Clamps Atrauma Bulldog
Pinze Atrauma Bulldog



DE BAKEY



13092-07
7,5 cm
3"



13092-08
8,5 cm
3.4"



13092-10
10,5 cm
4"



13092-12
12 cm
4 3/4"



13093-07
7 cm
2 3/4"



13093-08
8 cm
8 1/8"



13093-10
10 cm
4"



13093-12
11,5 cm
4 1/2"



GLOVER



13096-06
6 cm
2 1/4"



13096-07
7 cm
2 3/4"



13096-09
9 cm
3 1/2"



13096-11
11 cm
4 3/8"



13097-06
5,5 cm
2"



13097-07
6,5 cm
2 1/2"



13097-09
8,5 cm
3 1/4"



13097-11
10,5 cm
4"

Gefäßklemmen, Bulldogklemmen, Arterienklemmen
 Hemostatic Forceps
 Pinzas hemostáticas
 Pinze serraфина, Pinze emostatiche



DIEFFENBACH
 13102-04 3,5 cm, 1.4"
 13102-05 5,5 cm, 2.2"



DIEFFENBACH
 13103-04 3,5 cm, 1.4"
 13103-05 5,5 cm, 2.2"

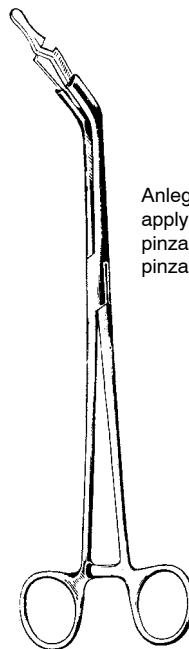
gerade
 straight
 recta
 rette



gebogen
 curved
 curva
 curve

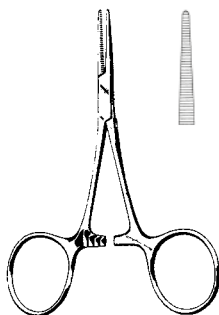
JOHNS-HOPKINS

13110-50	5,0 cm, 2"	13111-50
13110-55	5,5 cm, 2.2"	13111-55
13110-65	6,5 cm, 2.6"	13111-65
13110-70	7,0 cm, 2 3/4"	13111-70
13110-75	7,5 cm, 3"	13111-75
13110-90	9,0 cm, 3 1/2"	13111-90

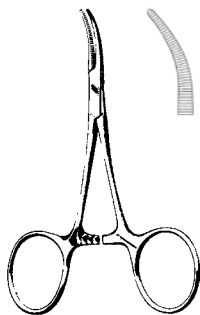


Anlegezange
 applying forceps
 pinza para poner
 pinza applicatrice

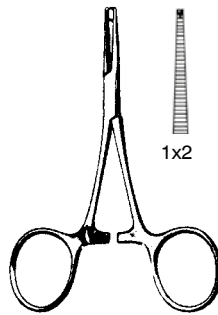
13115-00
 23 cm, 9"



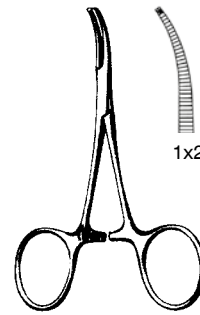
HARTMANN
 13210-10
 10 cm, 4"



HARTMANN
 13211-10
 10 cm, 4"



HARTMANN
 13212-10
 10 cm, 4"

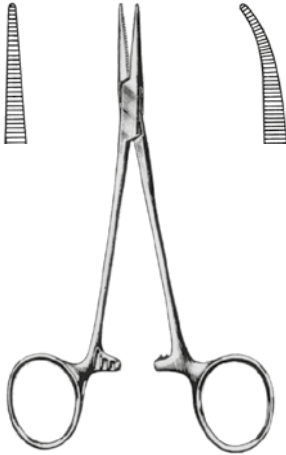


HARTMANN
 13213-10
 10 cm, 4"

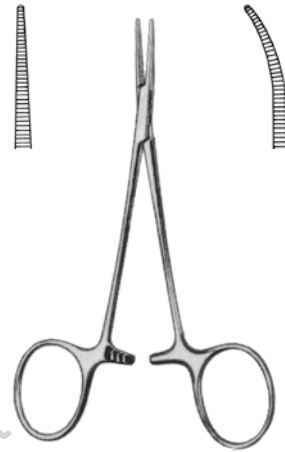
Micro-HARTMANN
 13214-10
 10 cm, 4"

Micro-HARTMANN
 13215-10
 10 cm, 4"

Arterienklemmen
Hemostatic Forceps
Pinzas hemostáticas
Pinze emostatiche

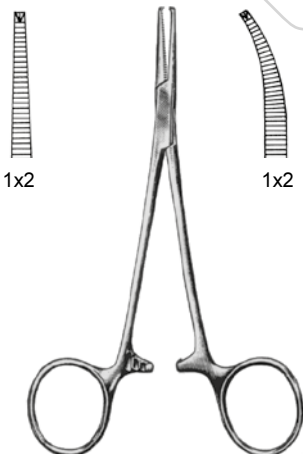


TITAN — HALSTED-MOSQUITO —
13224-12 13220-12 12,5 cm, 5" 13221-12
13220-14 14,0 cm, 5 1/2" 13221-14
13220-18 18,0 cm, 7" 13221-18
13220-21 21,0 cm, 8 1/4" 13221-21



TITAN — HALSTED-MOSQUITO micro —
13225-12 13222-12 12,5 cm, 5" 13223-12

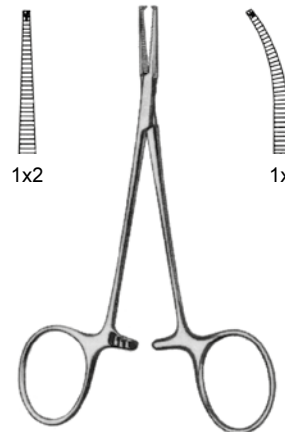
JACOBSON micro
13226-12 12,0 cm, 4 3/4" 13227-12



1x2

1x2

— HALSTED-MOSQUITO —
13230-12 12,5 cm, 5" 13231-12
13230-14 14,0 cm, 5 1/2" 13231-14
13230-18 18,0 cm, 7" 13231-18
13230-21 21,0 cm, 8 1/4" 13231-21

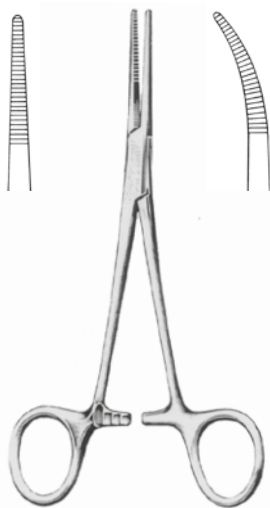


1x2

1x2

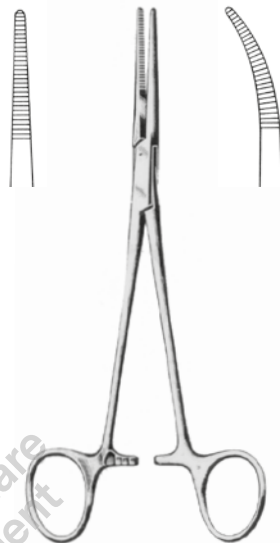
— HALSTED-MOSQUITO micro —
13232-12 13233-12

Arterienklemmen
Hemostatic Forceps
Pinzas hemostáticas
Pinze emostatiche



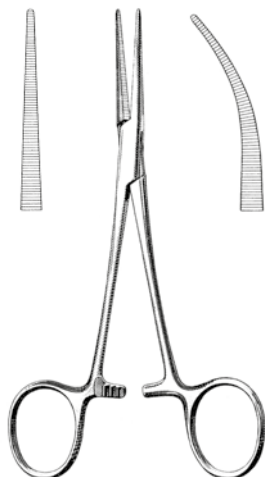
KELLY

13240-14	14 cm, 5 1/2"	13241-14
13240-18	18 cm, 7"	13241-18
13244-14	14 cm, 5 1/2"	13245-14
TITAN		TITAN



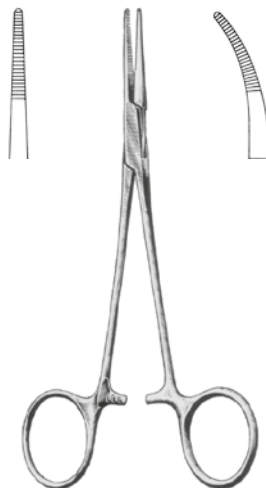
KELLY-RANKIN

13242-16	16 cm, 6 1/4"	13243-16
----------	---------------	----------



COLLER-CRILE

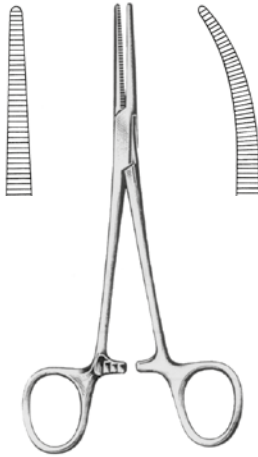
13256-14	14 cm, 5 1/2"	13257-14
13258-16	16 cm, 6 1/4"	13259-16



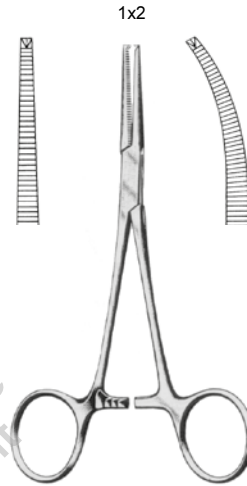
PROVIDENCE-HOSPITAL

13270-14	14 cm, 5 1/2"	13271-14
----------	---------------	----------

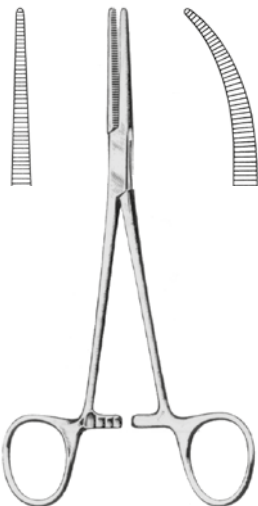
Arterienklemmen
Hemostatic Forceps
Pinzas hemostáticas
Pinze emostatiche



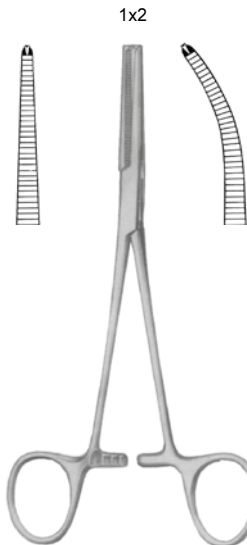
CRILE
13250-14 14 cm, 5 1/2" 13251-14
13250-18 18 cm, 7" 13251-18
13254-14 14 cm, 5 1/2" 13255-14
TITAN TITAN



1x2
CRILE
13260-14 14 cm, 5 1/2" 13261-14

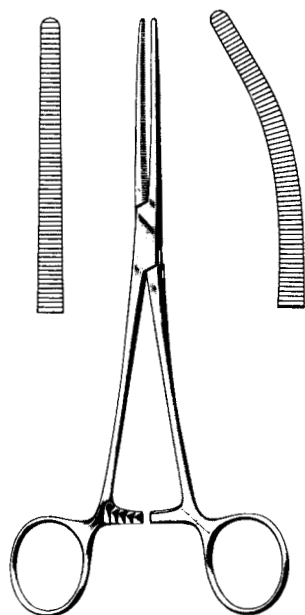


CRILE-RANKIN
13262-16 16 cm, 6 1/4" 13263-16



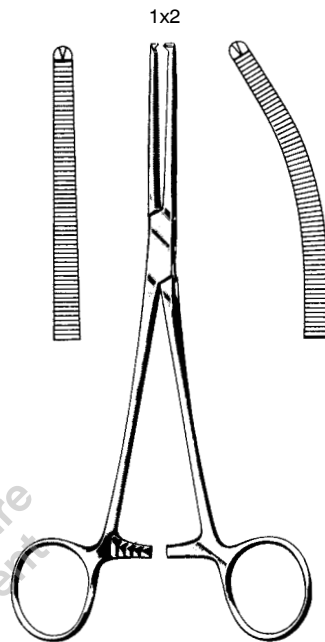
1x2
CRILE-RANKIN
13264-16 16 cm, 6 1/4" 13265-16

Arterienklemmen
Hemostatic Forceps
Pinzas hemostáticas
Pinze emostatiche



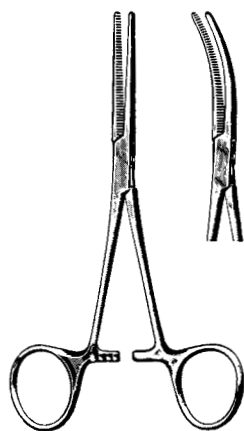
ROCHESTER-PEAN

13310-13	13 cm, 5 1/8"	13311-13
13310-14	14 cm, 5 1/2"	13311-14
13310-16	16 cm, 6 1/4"	13311-16
13310-18	18 cm, 7"	13311-18
13310-20	20 cm, 8"	13311-20
13310-22	22 cm, 8 3/4"	13311-22
13310-24	24 cm, 9 1/2"	13311-24
13310-26	26 cm, 10 1/4"	13311-26
13310-30	30 cm, 11 3/4"	13311-30



ROCHESTER-OGHSNER

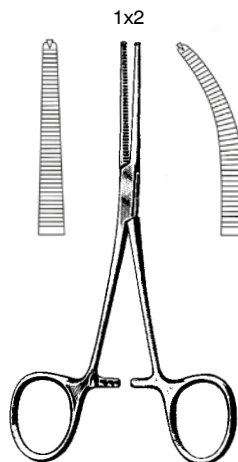
13320-13	13 cm, 5 1/8"	13321-13
13320-14	14 cm, 5 1/2"	13321-14
13320-16	16 cm, 6 1/4"	13321-16
13320-18	18 cm, 7"	13321-18
13320-20	20 cm, 8"	13321-20
13320-22	22 cm, 8 3/4"	13321-22
13320-24	24 cm, 9 1/2"	13321-24
13320-26	26 cm, 10 1/4"	13321-26
13320-30	30 cm, 11 3/4"	13321-30



Fein
Delicate
Delicada
Fina

PEAN

13312-14	14 cm, 5 1/2"	13313-14
13312-16	16 cm, 6 1/4"	13313-16

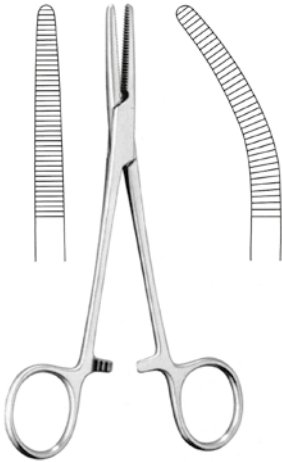


Fein
Delicate
Delicada
Fina

KOCHER

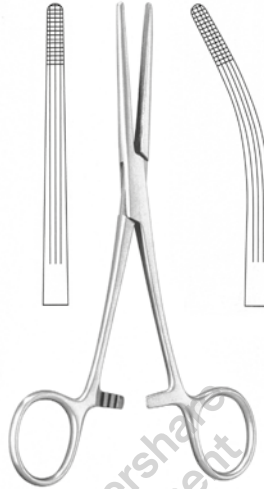
13322-14	14 cm, 5 1/2"	13323-14
13322-16	16 cm, 6 1/4"	13323-16

Arterienklemmen
Hemostatic Forceps
Pinzas hemostáticas
Pinze emostatiche



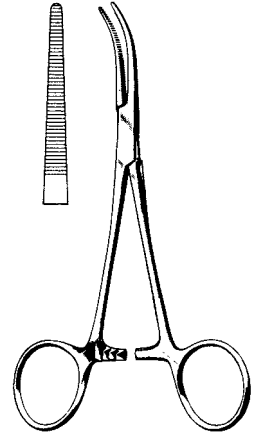
SPENCER-WELLS

13330-13	13 cm, 5"	13331-13
13330-15	15 cm, 6"	13331-15
13330-18	18 cm, 7"	13331-18
13330-20	20 cm, 8"	13331-20



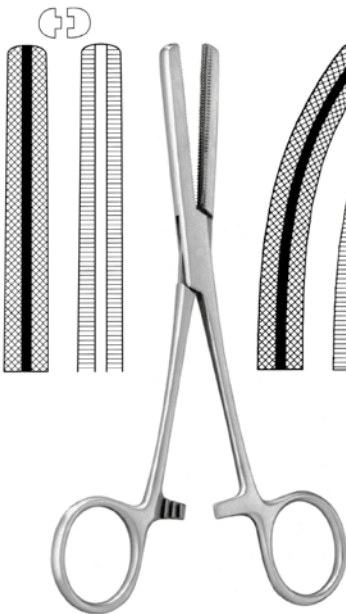
ROCHESTER-CARMALT

13340-16	16 cm, 6 1/4"	13341-16
13340-20	20 cm, 8"	13341-20



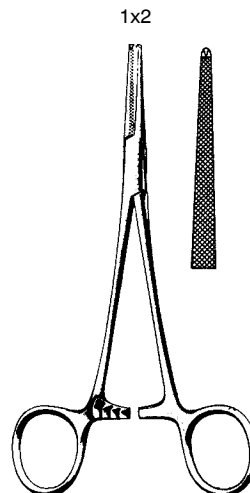
DANDY

13345-12	12 cm, 4 3/4"
13345-14	14 cm, 5 1/2"



FERGUSSON

13350-16	16 cm, 6 1/4"	13351-16
13350-20	20 cm, 8"	13351-20



LOVELACE

13356-15	15,5 cm, 6"
----------	-------------



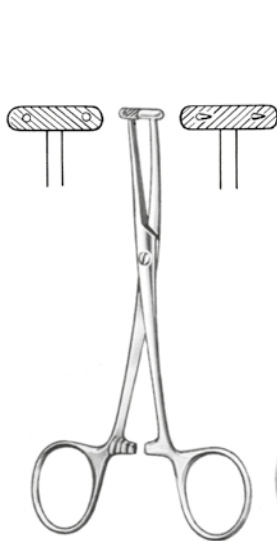
PENNINGTON

13358-15	15,5 cm, 6"
13358-20	20,0 cm, 8"

Fasszangen
Grasping Forceps
Pinza para agarrar 6rganos y tejidos
Pinze da presa



PRATT
13360-15 15 cm, 6"



MARTEL
13364-14 14 cm, 5 1/2"



WILLET MARTEL
13366-19 19 cm, 7 1/2"



PEAN
13368-14 14 cm, 5 1/2"
13368-16 16 cm, 6 1/4"



CHAPUT
13370-13
13 cm, 5 1/8"



TUFFIER
13372-13
13 cm, 5 1/8"



COLLIN
13374-14
14 cm, 5 1/2"



COLLIN
13376-16
16 cm, 6 1/4"

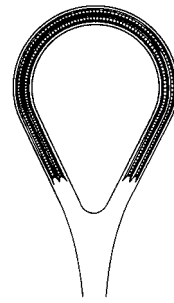
Organ- und Gewebefasszange, Arterienklemmen
 Organ- and Tissue Grasping Forceps, Hemostatic Forceps
 Pinza para agarrar órganos y tejidos, Pinzas hemostáticas
 Pinza per tessuti e organi, Pinze emostatiche



HADEO
 Atrauma
 13377-25 - 13377-26



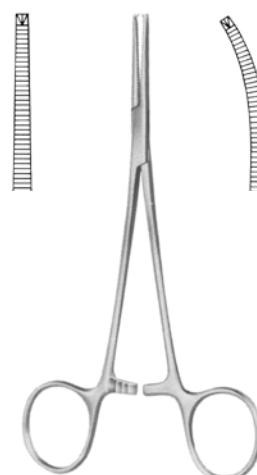
13377-25
 25 cm, 10"



13377-26
 26 cm, 10 1/4"

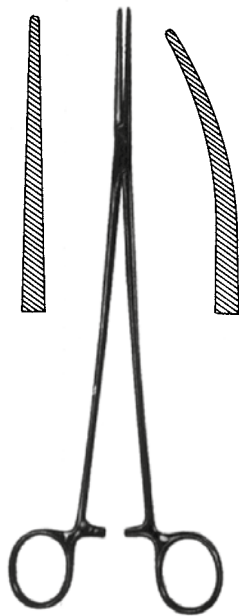


LERICHE
 13380-15 15 cm, 6" 13381-15

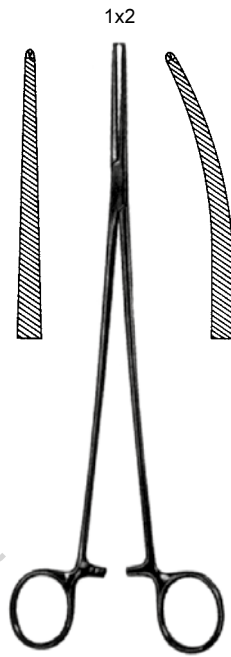


LERICHE
 13382-15 15 cm, 6" 13383-15

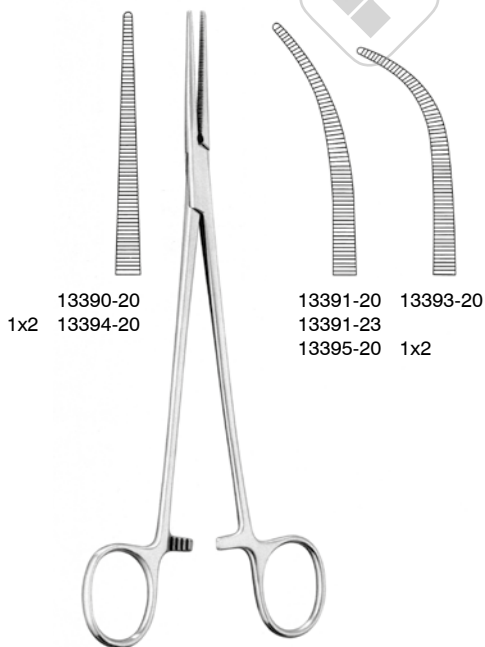
Arterienklemmen
 Hemostatic Forceps
 Pinzas hemostáticas
 Pinze emostatiche



BENGOLEA
 13384-20 20 cm, 8" 13385-20
 13384-26 26 cm, 10 1/4" 13385-26



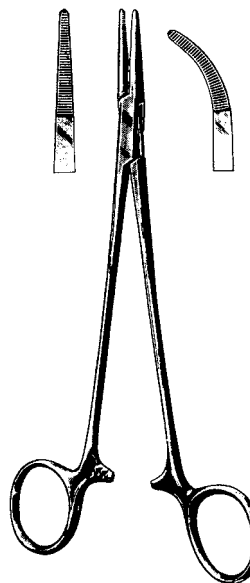
BENGOLEA
 13386-20 20 cm, 8" 13387-20
 13386-26 26 cm, 10 1/4" 13387-26



13390-20
 1x2 13394-20

13391-20 13393-20
 13391-23
 13395-20 1x2

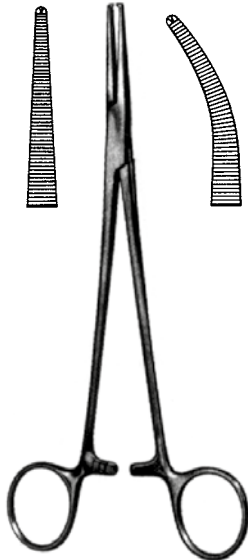
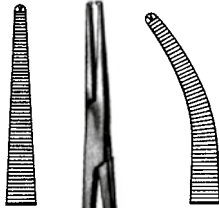
HEISS
 20 cm, 8"



ADSON
 13410-18 18,5 cm, 7 1/4" 13411-18

Arterienklemmen
Hemostatic Forceps
Pinzas hemostáticas
Pinze emostatiche

1x2



ADSON
13412-18 18,5 cm, 7 1/4" 13413-18



FUCHSIG
13414-20 19 cm, 7 1/2"



ADSON BABY
13415-14 14,0 cm, 5 1/2"
13415-18 18,5 cm, 7 1/4"

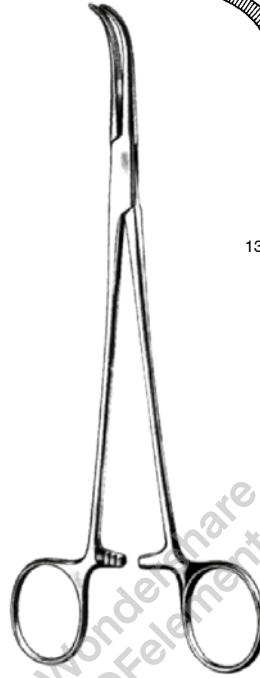


NISSEN
13416-18 18,5 cm, 7 1/4"

Arterienklemmen
 Hemostatic Forceps
 Pinzas hemostáticas
 Pinze emostatiche



OVERHOLT-BABY
 13420-14
 14 cm, 5 1/2"



OVERHOLT-GEISSENDOERFER
 21 cm, 8 1/4"



Fig. 1
 13421-01

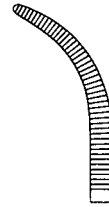


Fig. 2
 13421-02
 13425-02
 26 cm
 10 1/4"

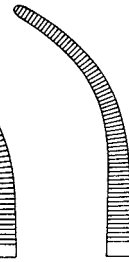


Fig. 3
 13421-03
 13425-03
 27 cm
 10 1/2"

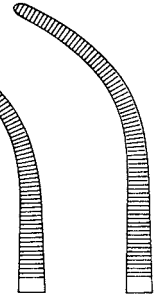


Fig. 4
 13421-04
 13425-04
 27,5 cm
 10,8"



Fig. 5
 13421-05
 13425-05
 27 cm
 10 1/2"



Fig. 6
 13421-06
 13425-06
 28 cm
 11"

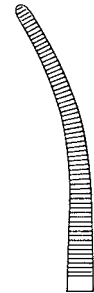


Fig. 7
 13421-07



OVERHOLT



13422-00
 21,5 cm
 8 1/2"
 Fig. 0



13422-01
 21 cm
 8 1/4"
 Fig. 1



13422-02
 22 cm
 8 3/4"
 Fig. 2

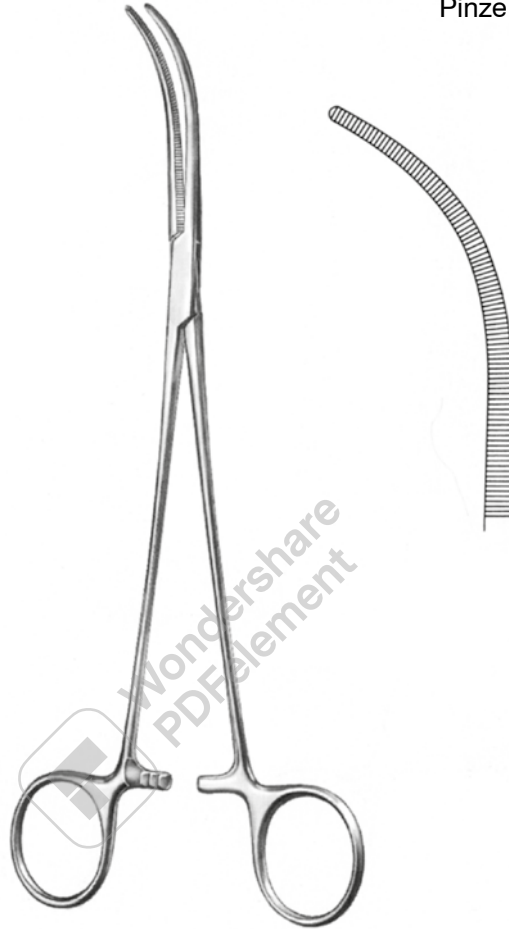


13422-03
 23 cm
 9"
 Fig. 3



13422-06
 22,5 cm
 8,9"
 Fig. 6

Arterienklemmen
 Hemostatic Forceps
 Pinzas hemostáticas
 Pinze emostatiche



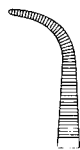
OVERHOLT-MIXTER
 13428-21
 21,5 cm, 8 1/2"



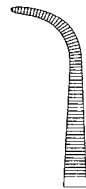
GEMINI



13431-13
 13 cm
 5 1/8"



13431-16
 16 cm
 6 1/4"



13431-18
 18 cm
 7"



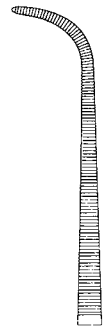
13431-20
 20 cm
 8"



13431-23
 23 cm
 9"

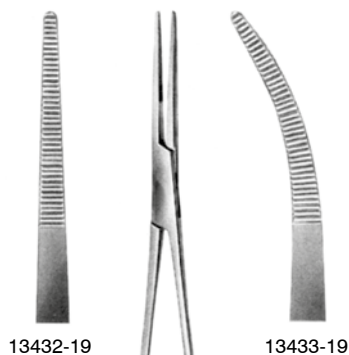


13431-25
 25 cm
 10"



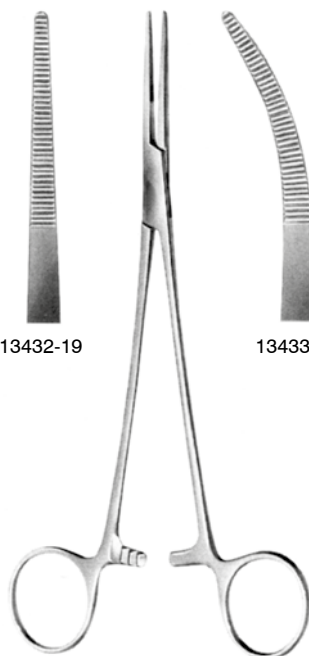
13431-28
 28 cm
 11"

Arterienklemmen
 Hemostatic Forceps
 Pinzas hemostáticas
 Pinze emostatiche

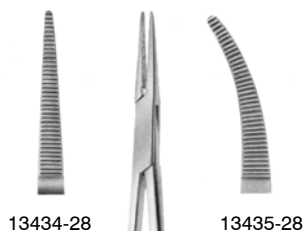


13432-19

13433-19

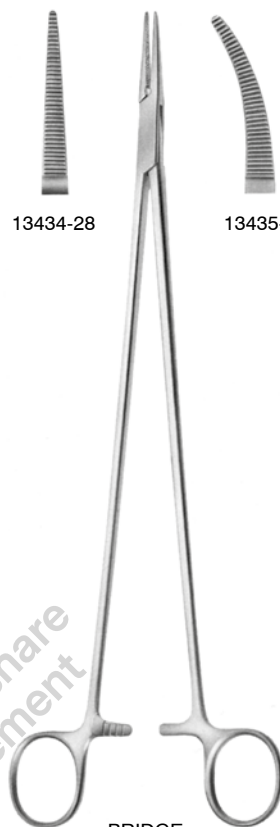


BIRKETT
 18,5 cm, 7 1/4"



13434-28

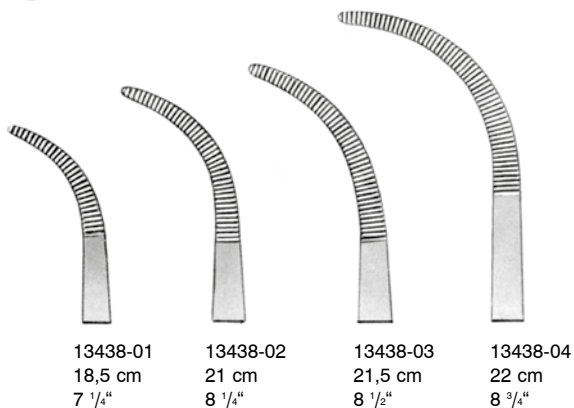
13435-28



BRIDGE
 27,5 cm, 10 3/4"



MIXTER



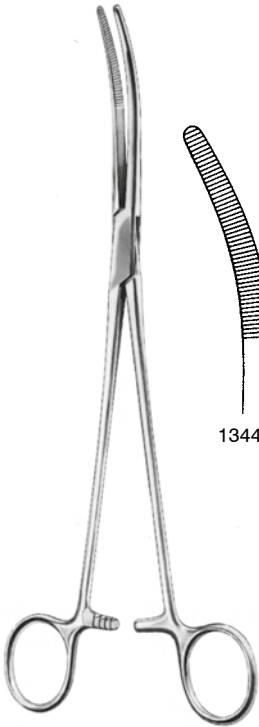
13438-01
 18,5 cm
 7 1/4"

13438-02
 21 cm
 8 1/4"

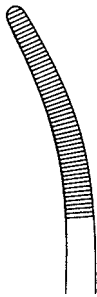
13438-03
 21,5 cm
 8 1/2"

13438-04
 22 cm
 8 3/4"

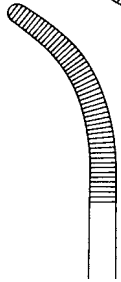
Arterienklemmen
Hemostatic Forceps
Pinzas hemostáticas
Pinze emostatiche



RUMEL
23 cm, 9"



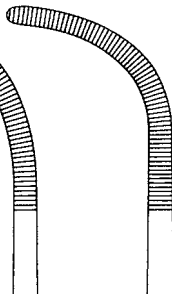
13441-01



13441-02



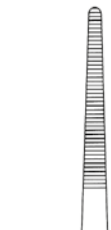
13441-03



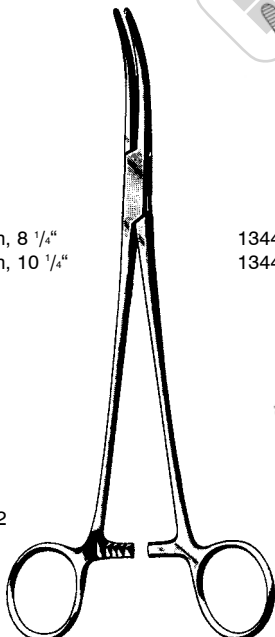
13441-04



WIKSTROEM
13447-20
20,5 cm, 8"

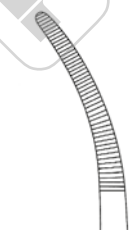


13442-21 21 cm, 8 1/4"
13442-26 26 cm, 10 1/4"

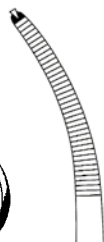


TOENNIS

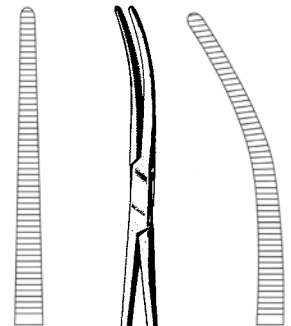
13444-21 21 cm, 8 1/4"
13444-26 26 cm, 10 1/4"



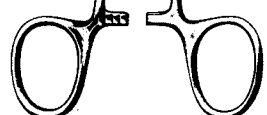
13443-21 21 cm, 8 1/4"
13443-26 26 cm, 10 1/4"



13445-21 21 cm, 8 1/4"
13445-26 26 cm, 10 1/4"



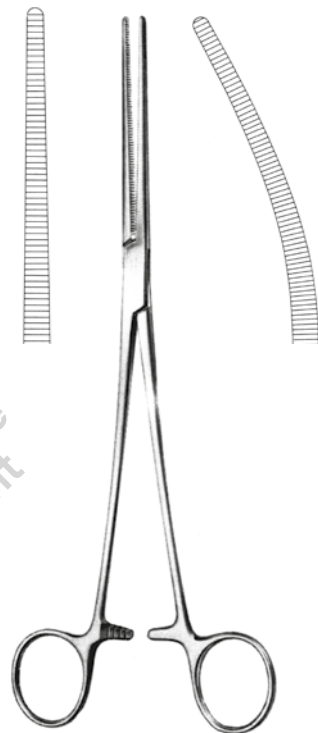
ROBERTS
13448-22 22 cm, 8 3/4" 13449-22



Arterienklemmen
Hemostatic Forceps
Pinzas hemostáticas
Pinze emostatiche



CRAFOORD
13453-18 18 cm, 7"
13453-24 24 cm, 9 1/2"



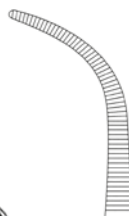
SAROT
13450-24 24 cm, 9 1/2" 13451-24



13455-01

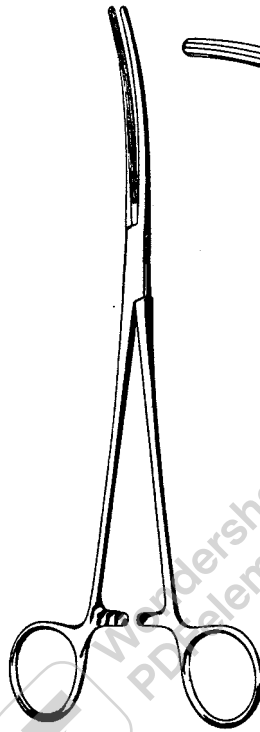


ZENKER
29,5 cm, 11 1/2"

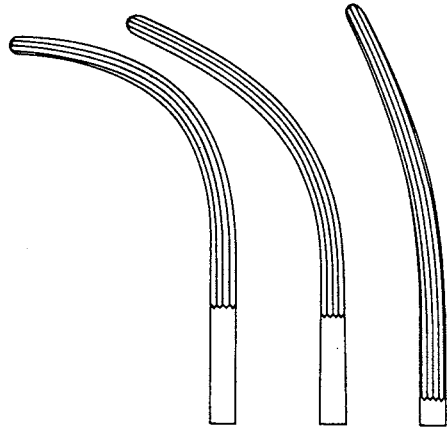


13455-02

Arterienklemmen
 Hemostatic Forceps
 Pinzas hemostáticas
 Pinze emostatiche



CRAFOORD-SELLORS
 24 cm, 9 1/2"



13456-01 13456-02 13456-03

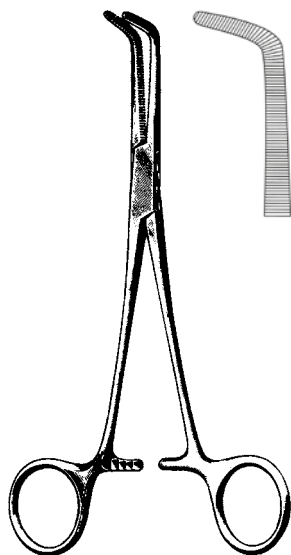


LAWRENCE
 13457-28 28 cm, 11"



MEEKER
 13459-18 18 cm, 7"
 13459-28 28 cm, 11"

Arterienklemmen
Hemostatic Forceps
Pinzas hemostáticas
Pinze emostatiche



MIXTER

13471-14 14 cm, 5 1/2"
13471-16 16 cm, 6 1/4"
13471-18 18 cm, 7"
13471-23 23 cm, 9"



MIXTER

13473-22
22 cm, 8 3/4"



KANTROWITZ

13474-19 19 cm, 7 1/2"
13474-24 24 cm, 9 1/2"
13474-26 26 cm, 10 1/4"



MIXTER BABY

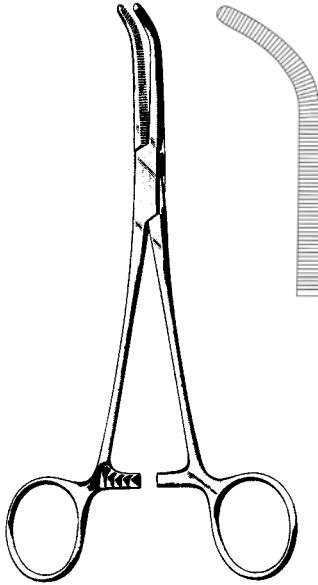
13475-14
14 cm, 5 1/2"



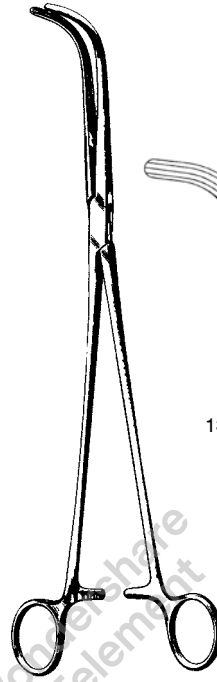
MIXTER BABY

13475-18
18 cm, 7"

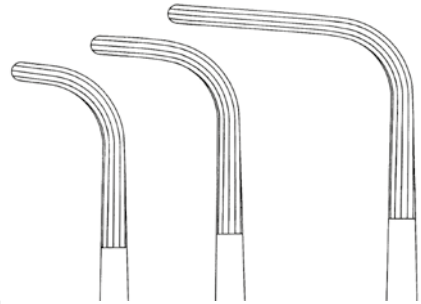
Arterienklemmen
Hemostatic Forceps
Pinzas hemostáticas
Pinze emostatiche



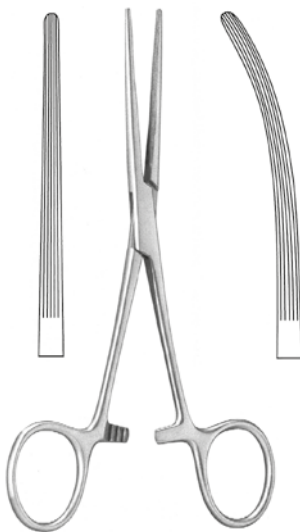
MIXTER-O'SHAUGHNESSY
13477-15 15,5 cm, 6"
13477-19 19,0 cm, 7 1/2"



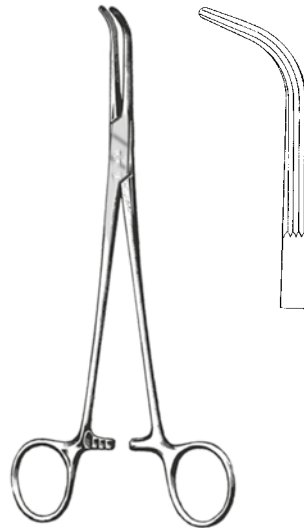
MIXTER



13479-22	13479-25	13479-28
22 cm	25 cm	28 cm
8 3/4"	10"	11"

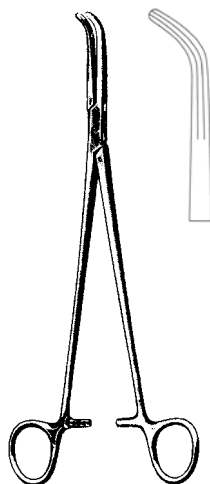


BAINBRIDGE
13480-15 15,0 cm, 6" 13481-15
13480-18 18,5 cm, 7 1/4" 13481-18

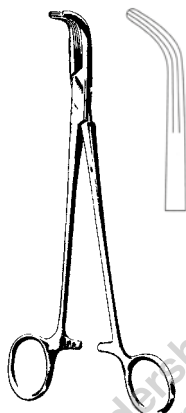


LAHEY
13491-19 19 cm, 7 1/2"

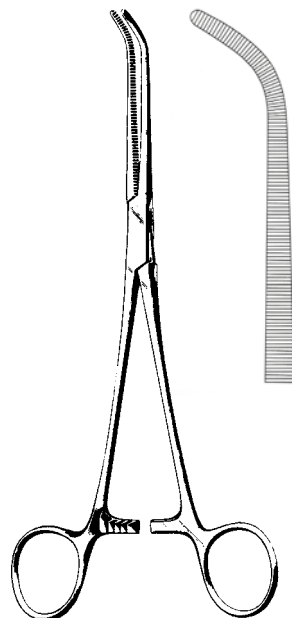
Arterienklemmen
Hemostatic Forceps
Pinzas hemostáticas
Pinze emostatiche



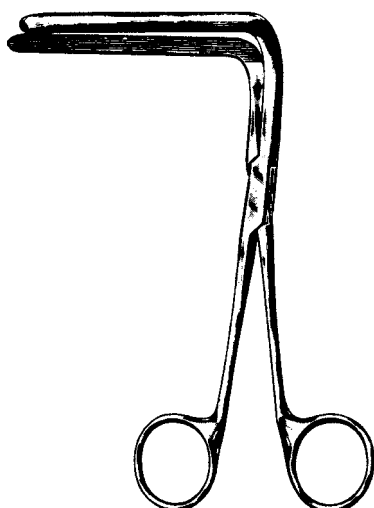
LAHEY
13493-23 23 cm, 9"



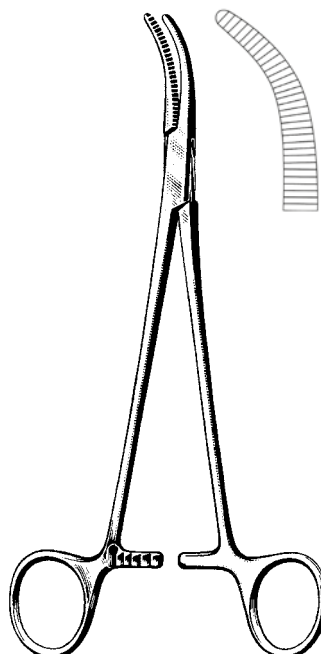
LOWER
13495-18 18 cm, 7"



JOHNS-HOPKINS
13497-20 20 cm, 8"

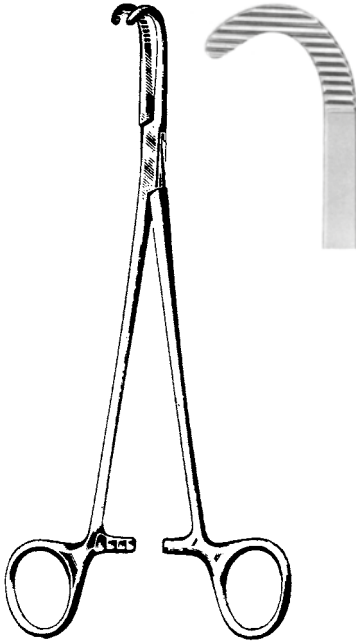


MIXTER
13499-16
16,5 cm, 6 1/2"

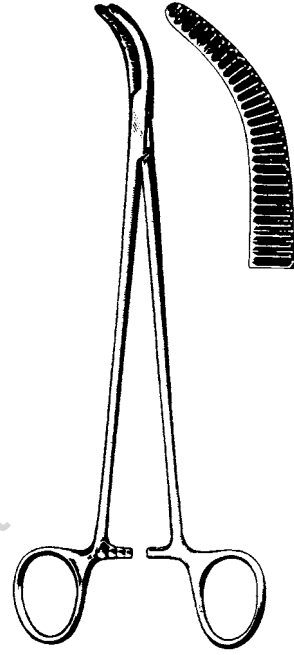


MOYNIHAN
13501-23
23 cm, 9"

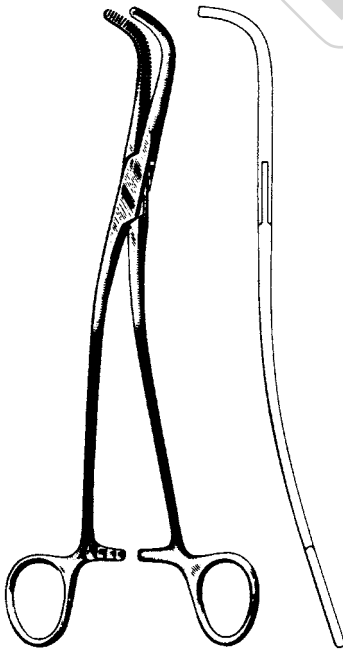
Arterienklemmen
Hemostatic Forceps
Pinzas hemostáticas
Pinze emostatiche



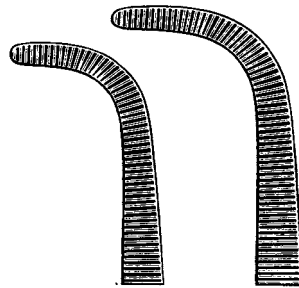
DESJARDINS
13503-21 21 cm, 8 1/4"



DESJARDINS
13505-21 21 cm, 8 1/4"



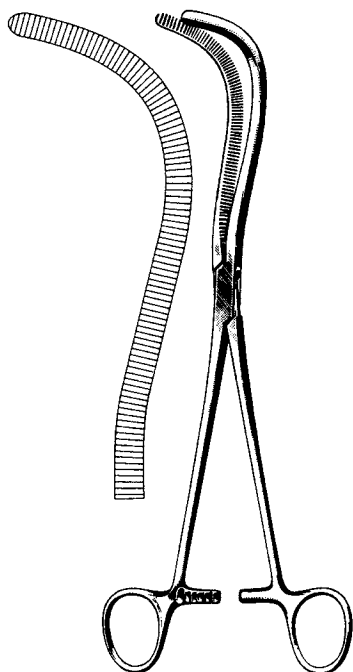
GRAY



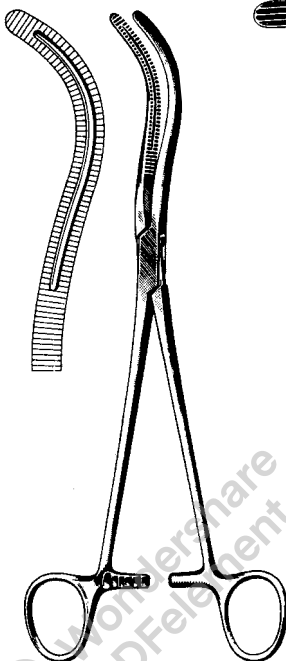
13507-22
22 cm
8 3/4"

13507-23
23 cm
9"

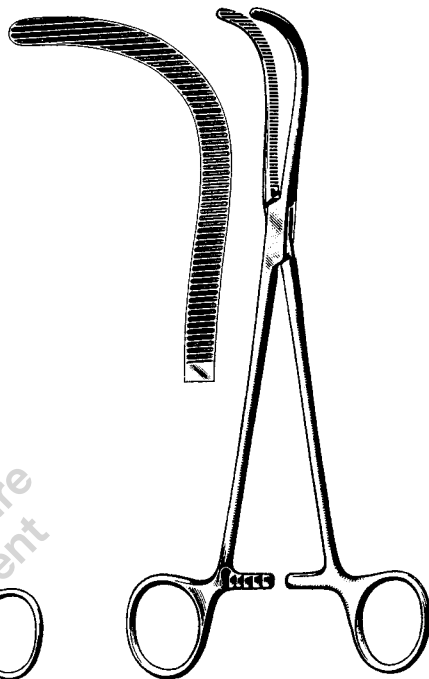
Arterienklemmen
 Hemostatic Forceps
 Pinzas hemostáticas
 Pinze emostatiche



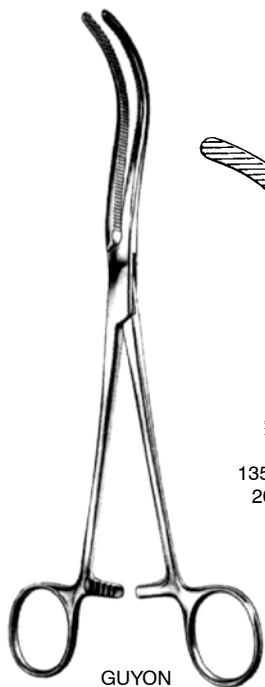
MAYO-GUYON
 13513-23
 23 cm, 9"



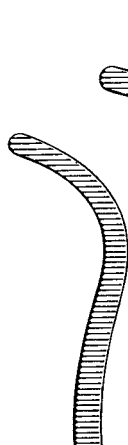
STILLE
 13515-23
 23 cm, 9"



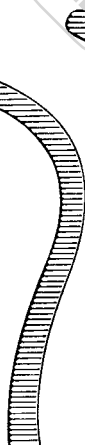
GUYON
 13517-23
 23 cm, 9"



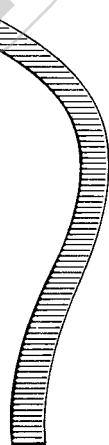
GUYON



13519-20
 20 cm
 8"



13519-22
 22 cm
 8 3/4"



13519-24
 24 cm
 9 1/2"



GUYON

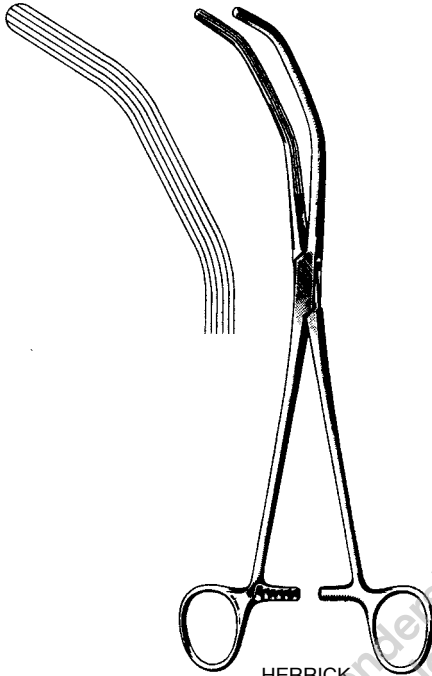


13520-24
 24 cm
 9 1/2"

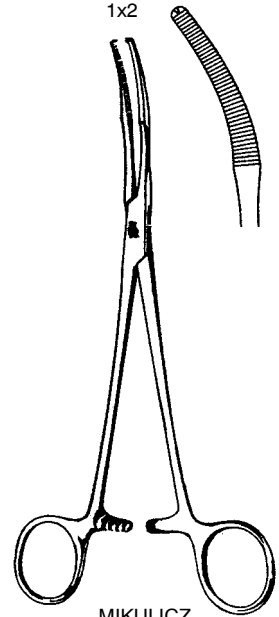
13520-23
 23 cm
 9"

ATRAUMA

Hysterektomieklemmen
Hysterectomy Forceps
Pinzas para histerectomía
Pinze per isterectomia

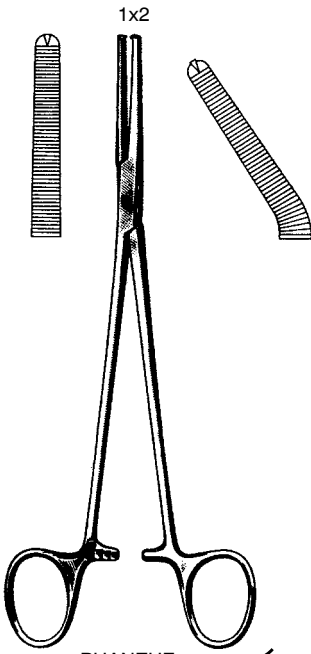


HERRICK
13523-23
23 cm, 9"



MIKULICZ
13551-14 14 cm, 5 1/2" BABY
13551-18 18 cm, 7"
13551-20 20 cm, 8"

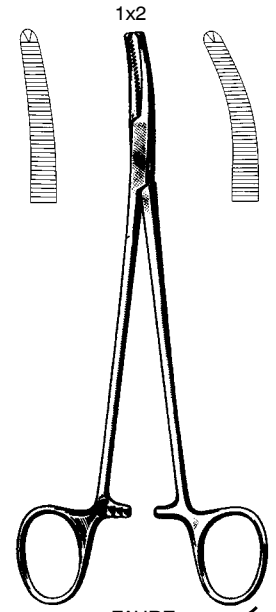
Peritoneum-Klemme
Peritoneum Forceps
Pinzas para peritoneo
Pinze peritoneali



PHANEUF
13554-21 21 cm, 8 1/4" 13555-21

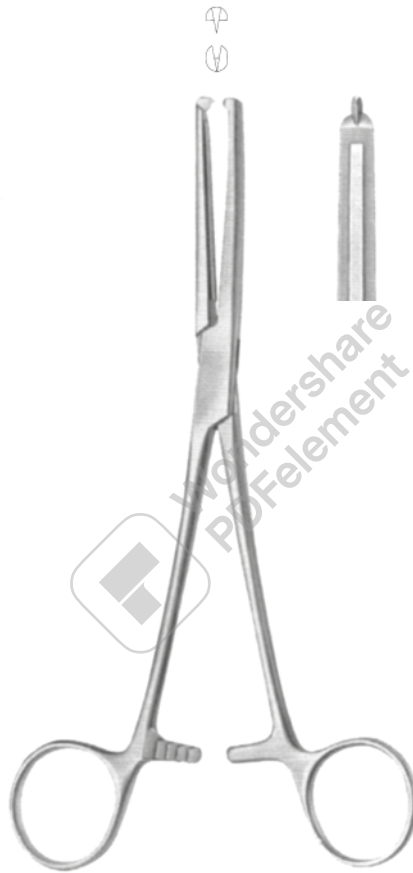


MIKULICZ
13556-24 24 cm, 9 1/2"



FAURE
13561-20 20 cm, 8" 13563-20

Hysterektomieklemmen
Hysterectomy Forceps
Pinzas para histerectomía
Pinze per isterectomia



MAINGOT
13564-20 20 cm, 8"

Hysterektomieklemmen
Hysterectomy Forceps
Pinzas para histerectomía
Pinze per isterectomia

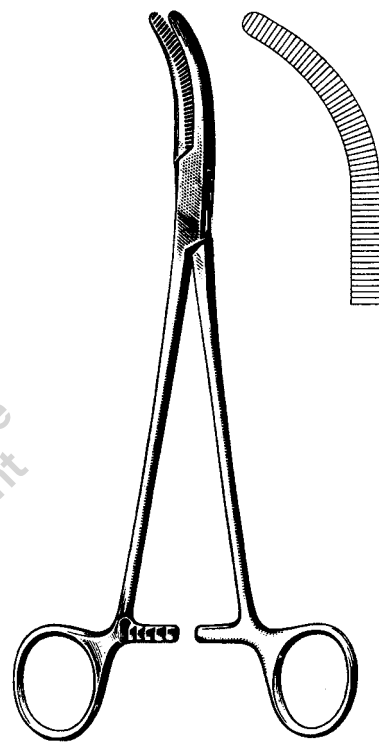


MAINGOT

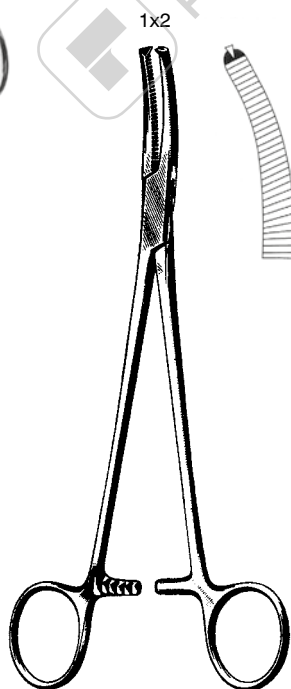
Hysterektomieklemmen
 Hysterectomy Forceps
 Pinzas para histerectomía
 Pinze per isterectomia



WERTHEIM
 13570-23
 23,5 cm, 9 1/4"



WERTHEIM
 13571-25
 25 cm, 10"



WERTHEIM
 13573-22 22 cm, 8 3/4"

Hysterektomieklemmen
Hysterectomy Forceps
Pinzas para histerectomía
Pinze per isterectomia



SEGOND-LANDAU
13574-24
24 cm, 9 1/2"

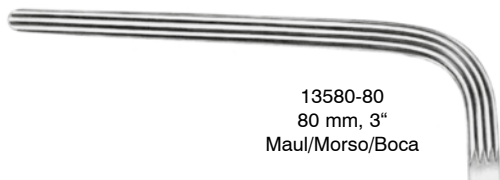


SEGOND
13575-24
24 cm, 9 1/2"

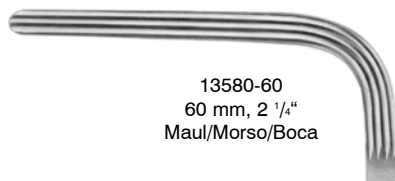


WERTHEIM-CULLEN
13579-21 21,5 cm, 8 1/2"

Hysterektomieklemmen Hysterectomy Forceps Pinzas para histerectomía Pinze per isterectomia



13580-80
80 mm, 3"
Maul/Morso/Boca



13580-60
60 mm, 2 1/4"
Maul/Morso/Boca



23 cm, 9"

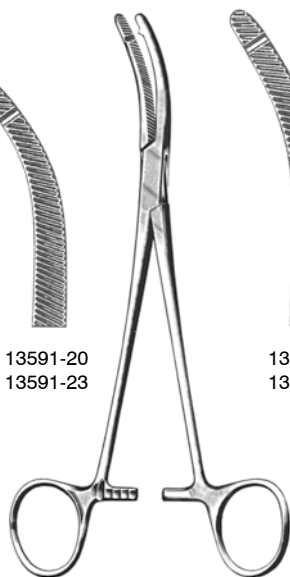


Wondershare
PDFelement

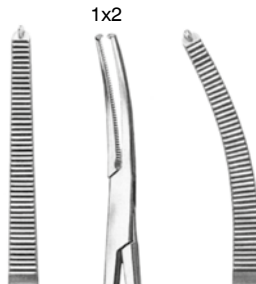


13591-20
13591-23

13593-20
13593-23



HEANEY
20 cm, 8"



1x2



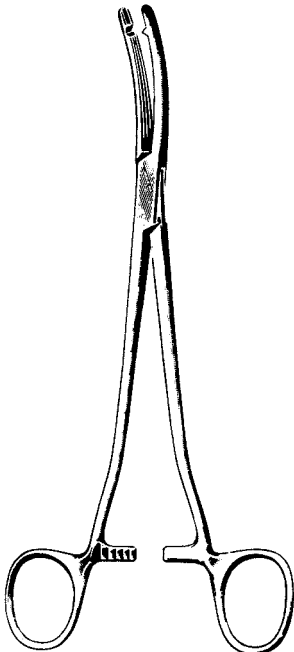
13598-24 HOLZBACH 13599-24
24 cm, 9 1/2"

Hysterektomieklemmen
Hysterectomy Forceps
Pinzas para histerectomía
Pinze per isterectomia

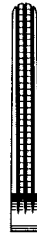


ATRAUMA

ROGERS
13595-10 - 13597-40



HEANY-BALLENTINE
13600-20 - 13601-20
20 cm, 8"



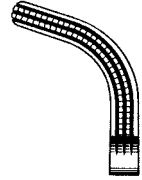
22 cm
8 3/4"
13595-10



21,5 cm
8 1/2"
13595-20



21 cm
8 1/4"
13595-30



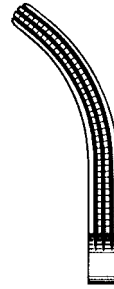
20,5 cm
8"
13595-40



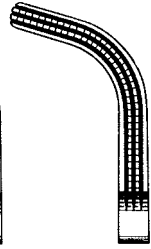
25 cm
10"
13597-10



25 cm
10"
13597-20



24,5 cm
9 3/4"
13597-30



23 cm
9"
13597-40

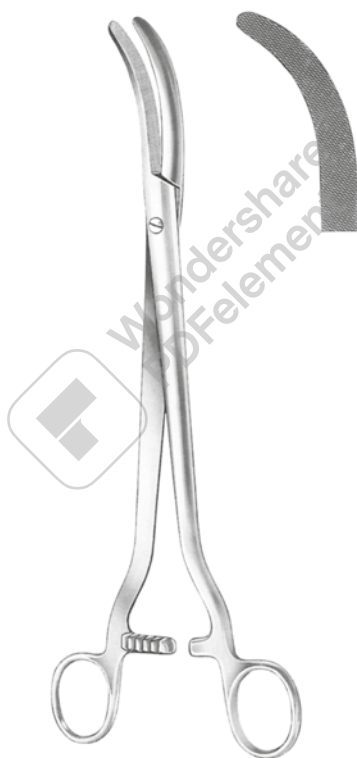


BALLENTINE
13600-20



HEANY-BALLENTINE
13601-20

Hysterektomieklemmen
Hysterectomy Forceps
Pinzas para histerectomía
Pinze per isterectomia



WERTHEIM
13605-26
25,5 cm, 10"

Parametriumklemmen
 Parametrium Clamps
 Pinza para parametrio
 Pinza per parametrio



HADEO
 21 cm 8 1/4"



13610-21



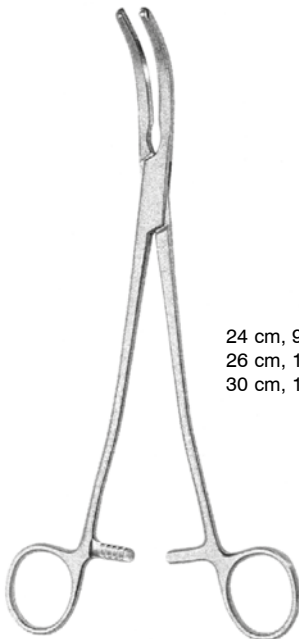
13611-21



13612-21



13613-21



HADEO



24 cm, 9 1/2"
 26 cm, 10 1/4"
 30 cm, 12"

13620-24
 13620-26
 13620-30



13621-24
 13621-26
 13621-30



13622-24
 13622-26
 13622-30



13623-24
 13623-26
 13623-30



Schlauchklemmen
 Tubing Clamps
 Pinzas cierra-tubos
 Pinze serratubi



KLINIKUM BERLIN
 13702-14
 14,5 cm, 5 3/4"



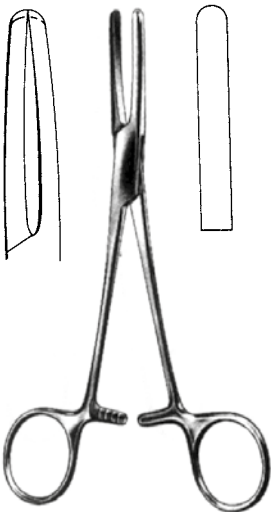
13710-15
 15 cm, 6"



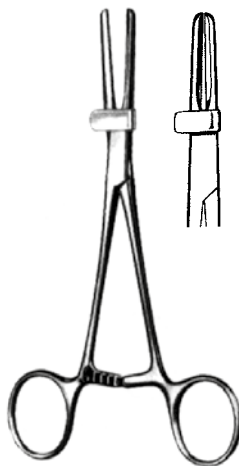
13710-18
 18 cm, 7"



13710-20
 20 cm, 8"



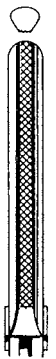
PRESBYTERIAN
 13704-16 16 cm, 6 1/4"
 13704-18 18 cm, 7"



13712-15
 15 cm, 6"



13712-18
 18 cm, 7"



13712-20
 20 cm, 8"

Rollenklemme
Tube milking rollers
Pinza de rodillos
Pinze con rotelle



BÜLOW-GUNAR-HEY
13720-18 18 cm, 7"

Rollenklemme
Tube milking rollers
Pinza de rodillos
Pinze con rotelle



13730-16 16,5 cm, 6 1/2"

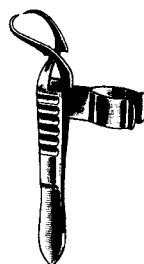
Tuchklemmen
Towel Forceps
Pinzas de campos
Pinze fissateli



SCHAEDEL
15101-09
9 cm, 3 1/2"

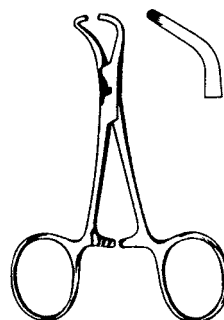


JONES
15103-07
7 cm, 2 3/4"



JONES-CLIP
15105-09
9 cm, 3 1/2"

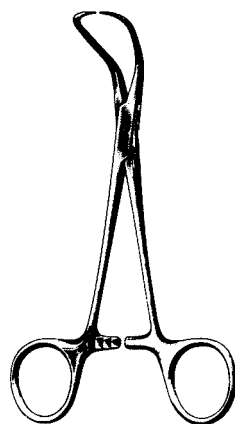
15103-09
9 cm, 3 1/2"



TOHUKU
15107-10 10 cm, 4"
15107-13 13 cm, 5 1/8"



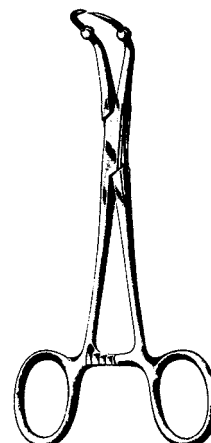
PEERS
15108-14
14,5 cm, 5 3/4"



BACKHAUS
15111-09 9 cm, 3 1/2"
15111-11 11 cm, 4 3/8"
15111-13 13 cm, 5 1/8"
15111-15 15 cm, 6"

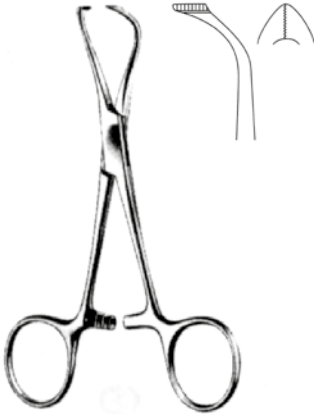


BACKHAUS-CLIP
15115-11
11 cm, 4 3/8"



ROEDER
15117-13
13 cm, 5 1/8"

Tuchklemmen
Towel Forceps
Pinzas de campos
Pinze fissateli



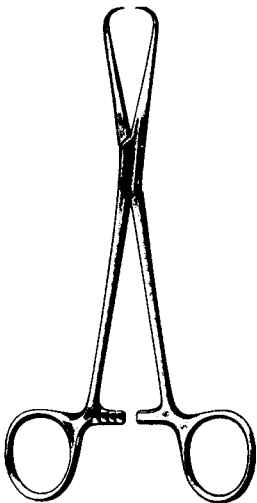
LORNA
15121-11 11 cm, 4 $\frac{3}{8}$ "
15121-13 13 cm, 5 $\frac{1}{8}$ "



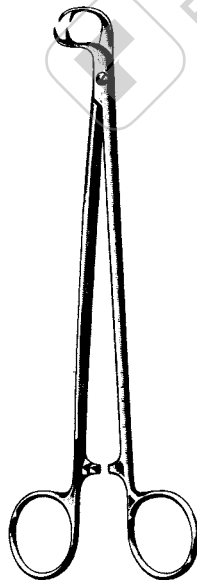
BALL AND SOCKET
15123-11 11 cm, 4 $\frac{3}{8}$ "
15123-13 13 cm, 5 $\frac{1}{8}$ "



15125-14
14,5 cm, 5 $\frac{3}{4}$ "



BERNHARD
15140-16
16,5 cm, 6 $\frac{1}{2}$ "



MOYNIHAN
15150-19
19 cm, 7 $\frac{1}{2}$ "

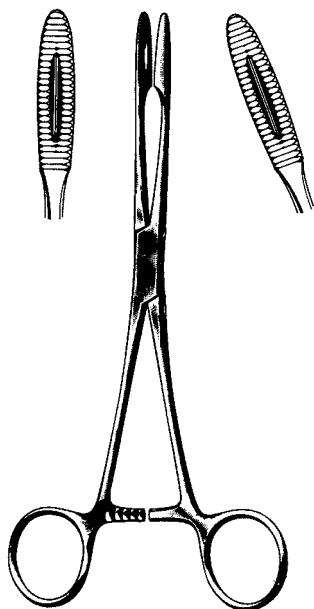


DOYEN
15161-18
18 cm, 7"

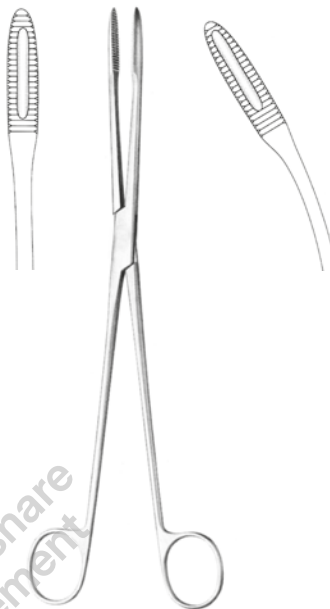


LANE
15164-15 15 cm, 6"
15164-20 20 cm, 8"

Tupfer- und Kornzangen
 Dressing Forceps
 Pinzas para tampones y curaciones
 Pinze per tamponi e per medicazione



GROSS-MAIER
 17110-20 20 cm, 8" 17111-20
 17110-25 25 cm, 10" 17111-25



GROSS-MAIER
 17112-20 20 cm, 8" 17113-20
 17112-25 25 cm, 10" 17113-25



17120-28

17121-28



SIMS-MAIER
 28 cm, 11"

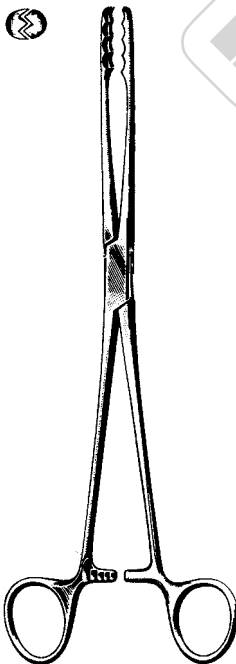


DUPLAY
 17131-21 21 cm, 8 1/4"

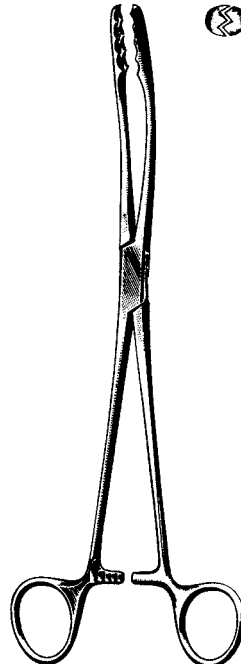
Tupfer- und Kornzangen
Dressing Forceps
Pinzas para tampones y curaciones
Pinze per tamponi e per medicazione



17133-17 17 cm, 6 3/4"

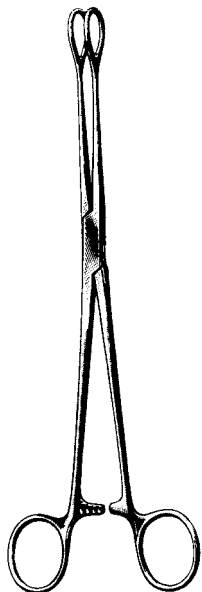


ULRICH
17160-22 22 cm, 8 3/4"
17160-25 25 cm, 10"

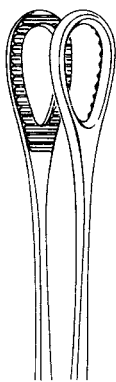


ULRICH
17161-22 22 cm, 8 3/4"
17161-25 25 cm, 10"

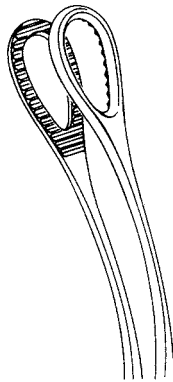
Schwammzange
 Sponge Forceps
 Pinzas porta-esponjas
 Pinze per spugne



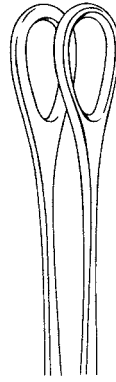
FOERSTER



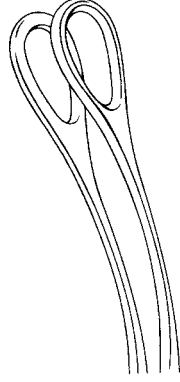
17170-18
 17170-20
 17170-25
 17170-30



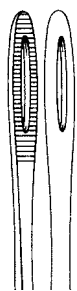
17171-18 18 cm, 7"
 17171-20 20 cm, 8"
 17171-25 25 cm, 10"



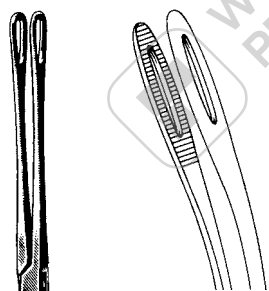
17172-18
 17172-25



17173-18
 17173-25



17174-25



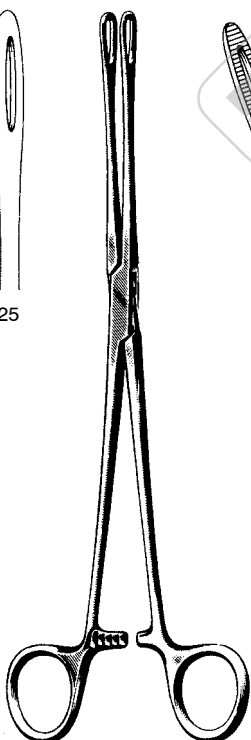
17175-25



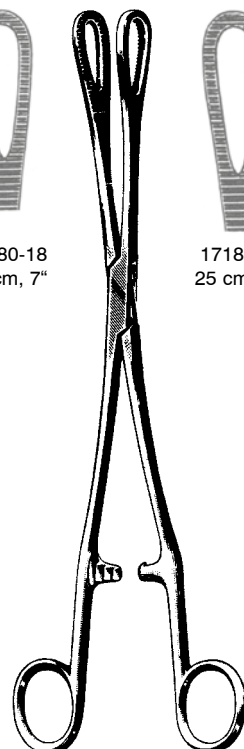
17180-18
 18 cm, 7"



17180-25
 25 cm, 10"



FOERSTER
 25 cm, 10"



RAMPLEY

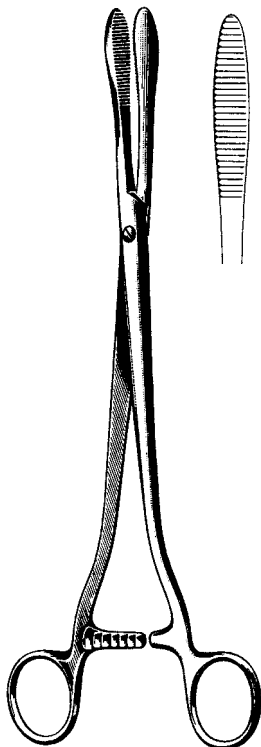
Kornzangen, Sinusklemmen
Dressing Forceps, Sinus Forceps
Pinzas para vendajes
Pinze per medicature, Pinze per seni



BRYANT
17207-13 13 cm, 5 1/8"



LISTER (Sinus)
17210-13 13 cm, 5 1/8"
17210-16 16 cm, 6 1/4"
17210-18 18 cm, 7"



COLLIN
17220-25 25 cm, 10"

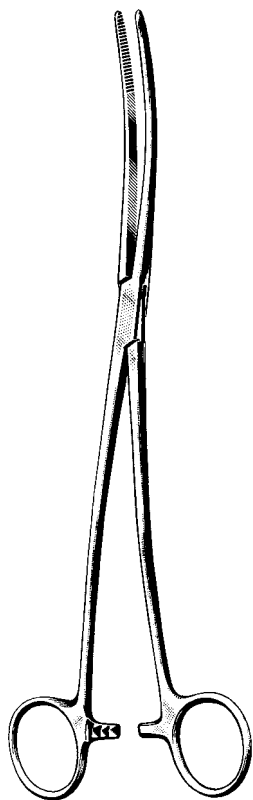


PELKMANN
25 cm, 10"

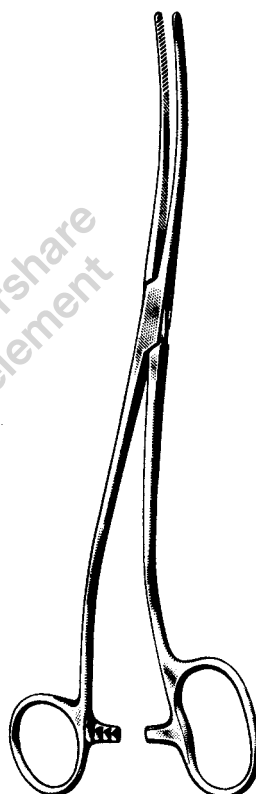
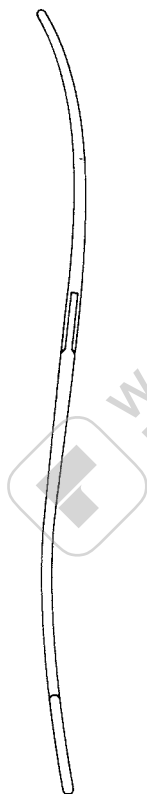


CHERON
17229-25 25 cm, 10"

Tamponzangen
Dressing Forceps
Pinzas para tapones
Pinze per tamponi



— BOZEMANN —
17230-26 17231-26
26 cm, 10 1/4"

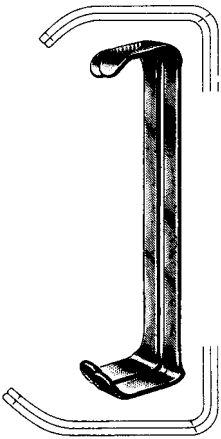


BOZEMANN-DOUGLAS
17233-26
26 cm, 10 1/4"

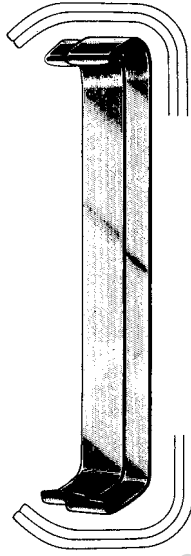


Wundhaken
Retractors
Separadores
Divaricatori

Satz, set, juego, serie



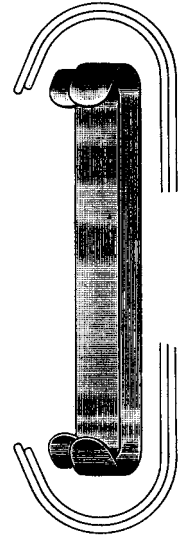
FARABEU
19102-12
12 cm, 4 3/4"



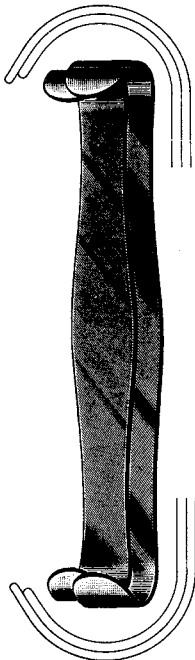
FARABEU
19102-15
15 cm, 6"



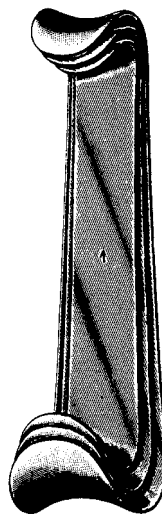
COLLIN
19104-15
15 cm, 6"



PARKER
19110-13
13,5 cm, 5 1/4"



PARKER
19110-18 18 cm, 7"



ROUX
19120-00

Fig. 1 = 24x20 mm
Fig. 2 = 29x26 mm
Fig. 3 = 35x29 mm

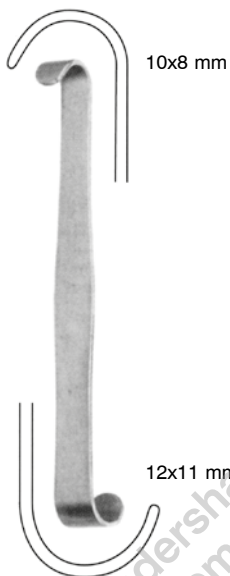
Fig. 1 = 30x28 mm
Fig. 2 = 36x36 mm
Fig. 3 = 38x43 mm

19120-14 Fig. 1 14 cm, 5 1/2"
19120-15 Fig. 2 15 cm, 6"
19120-17 Fig. 3 17 cm, 6 3/4"

Wundhaken
Retractors
Separadores
Divaricatori



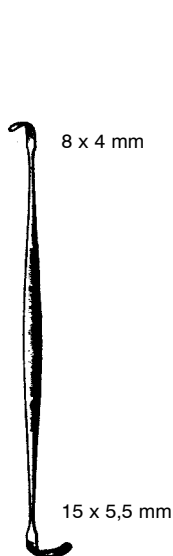
ROUX BABY
19122-13
13 cm, 5 1/8"



LUER
19123-11
11 cm, 4 3/8"



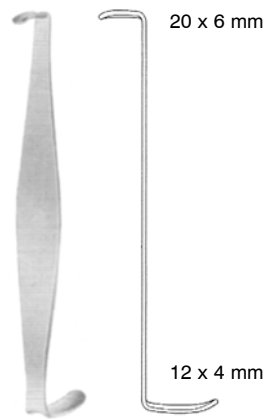
ROUX mini
19124-15
14 cm, 5 1/2"



RAGNELL
19125-14
14 cm, 5 1/2"



ROSE
19126-13
13 cm, 5 1/8"



CRILE
19127-11
11,5 cm, 4 1/2"

Wundhaken
Retractors
Separadores
Divaricatori

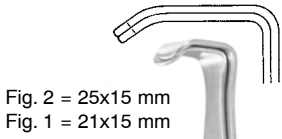


Fig. 2 = 25x15 mm
Fig. 1 = 21x15 mm

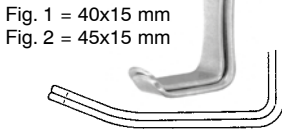
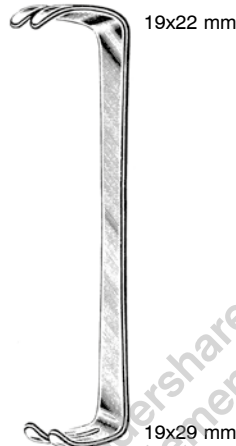


Fig. 1 = 40x15 mm
Fig. 2 = 45x15 mm

US ARMY / Parker-Langenbeck
19131-21 21 cm, 8 1/4"



19x22 mm

19x29 mm

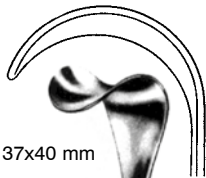
MAYO-COLLINS
19132-15 15 cm, 6"



Fig. 2 = 47x13 mm
Fig. 1 = 42x13 mm

Fig. 1 = 42x26 mm
Fig. 2 = 46x26 mm

MATHIEU
19134-20 20 cm, 8"

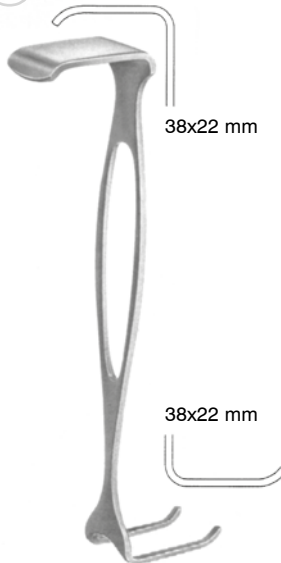


37x40 mm



30 x 31 mm

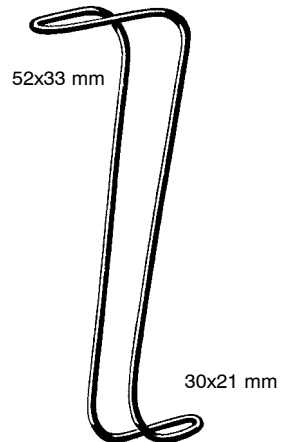
GOELET
19135-19 19 cm, 7 1/2"



38x22 mm

38x22 mm

CZERNY
19136-20 17,5 cm, 6.9"

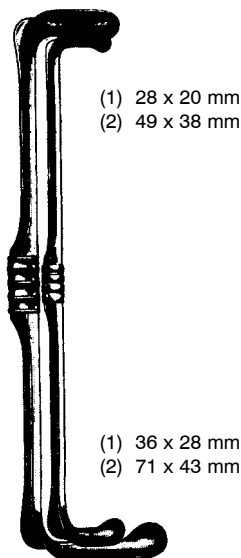


52x33 mm

30x21 mm

COLLIN-HARTMANN
19137-16 16 cm, 6 1/4"

Wundhaken
Retractors
Separadores
Divaricatori

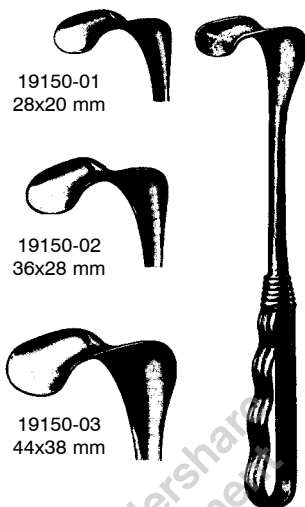


(1) 28 x 20 mm
(2) 49 x 38 mm

(1) 36 x 28 mm
(2) 71 x 43 mm

RICHARDSON-EASTMAN

- (Set) 19140-00
- (1) 19140-01 26 cm, 10 1/4"
- (2) 19140-02 28 cm, 11"



19150-01
28x20 mm

19150-02
36x28 mm

19150-03
44x38 mm

RICHARDSON

24 cm, 9 1/2"



47x21 mm

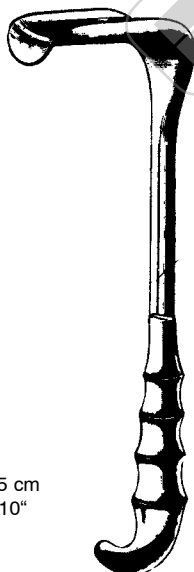
RICHARDSON

19150-04
24 cm, 9 1/2"



RICHARDSON GRIP

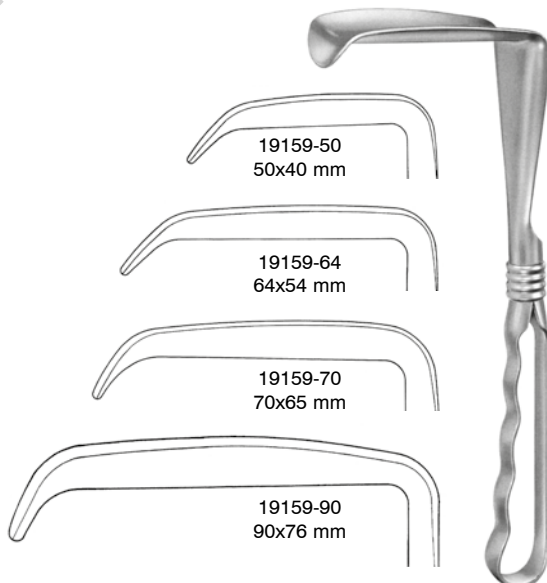
- 19152-25 20x25 mm
- 19152-31 25x31 mm
- 19152-38 38x38 mm
- 19152-51 19x51 mm
- 19152-64 41x64 mm



KELLY GRIP

- 19158-51 38x51 mm
- 19158-64 51x64 mm
- 19158-76 64x76 mm
- 19158-82 70x82 mm

25 cm
10"



19159-50
50x40 mm

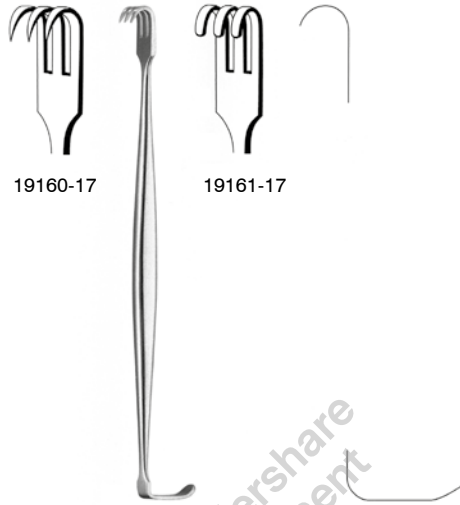
19159-64
64x54 mm

19159-70
70x65 mm

19159-90
90x76 mm

KELLY
26 cm, 10 1/4"

Wundhaken
Retractors
Separadores
Divaricatori



19160-17

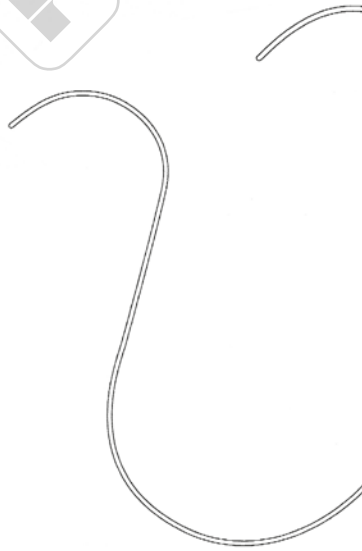
19161-17

SENN-MILLER
17 cm, 6 3/4"

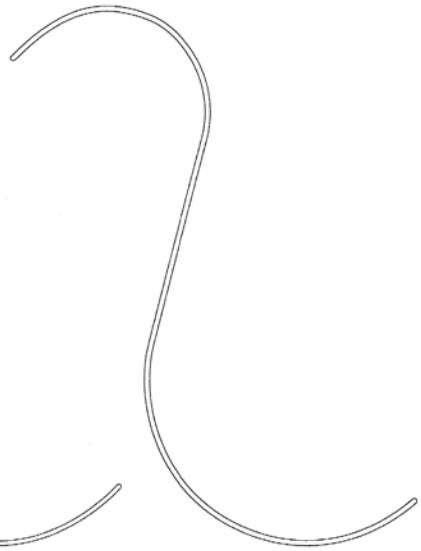


HASSON

Satz, set, juego, serie



19162-10 10 mm
16 cm, 6 1/4"



19162-13 13 mm
18 cm, 7"

Bauch- und Darmspatel
 Abdominal and intestinal spatulas
 Separadores, espátula intestinal y abdominal
 Divaricatori, spatole addominali e intestinali

biegsam, malleable, maleable, malleabili



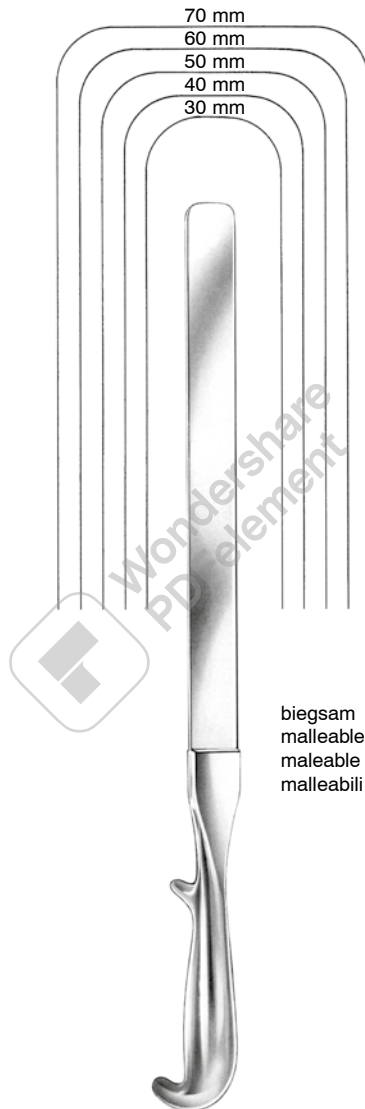
RIBBON

19168-06	6x200 mm
19168-08	8x200 mm
19168-10	10x200 mm
19168-12	12x200 mm
19168-17	17x200 mm
19168-20	20x200 mm
19168-25	25x200 mm
19169-25	25x250 mm

RIBBON

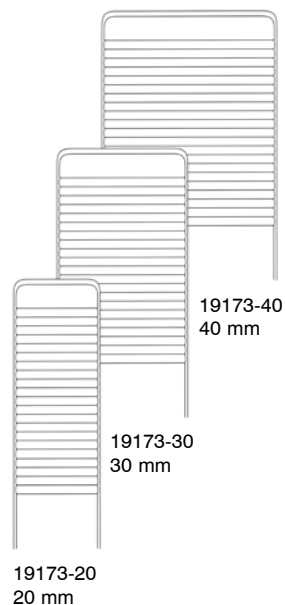
19170-20	20x330 mm
19170-25	25x330 mm
19170-32	32x330 mm
19170-40	40x330 mm
19170-45	45x330 mm
19170-50	50x330 mm
19170-65	65x330 mm
19170-76	76x330 mm

Bauch- und Darmspatel
Abdominal and intestinal spatulas
Separadores, espátula intestinal y abdominal
Divaricatori, spatole addominali e intestinali



41 cm, 16"
19171-30 30 mm
19171-40 40 mm
19171-50 50 mm
19171-60 60 mm
19171-70 70 mm

Bauch- und Darmspatel
Abdominal and intestinal spatulas
Separadores, espátula intestinal y abdominal
Divaricatori, spatole addominali e intestinali



biegsam
malleable
maleable
malleabili

HABERER

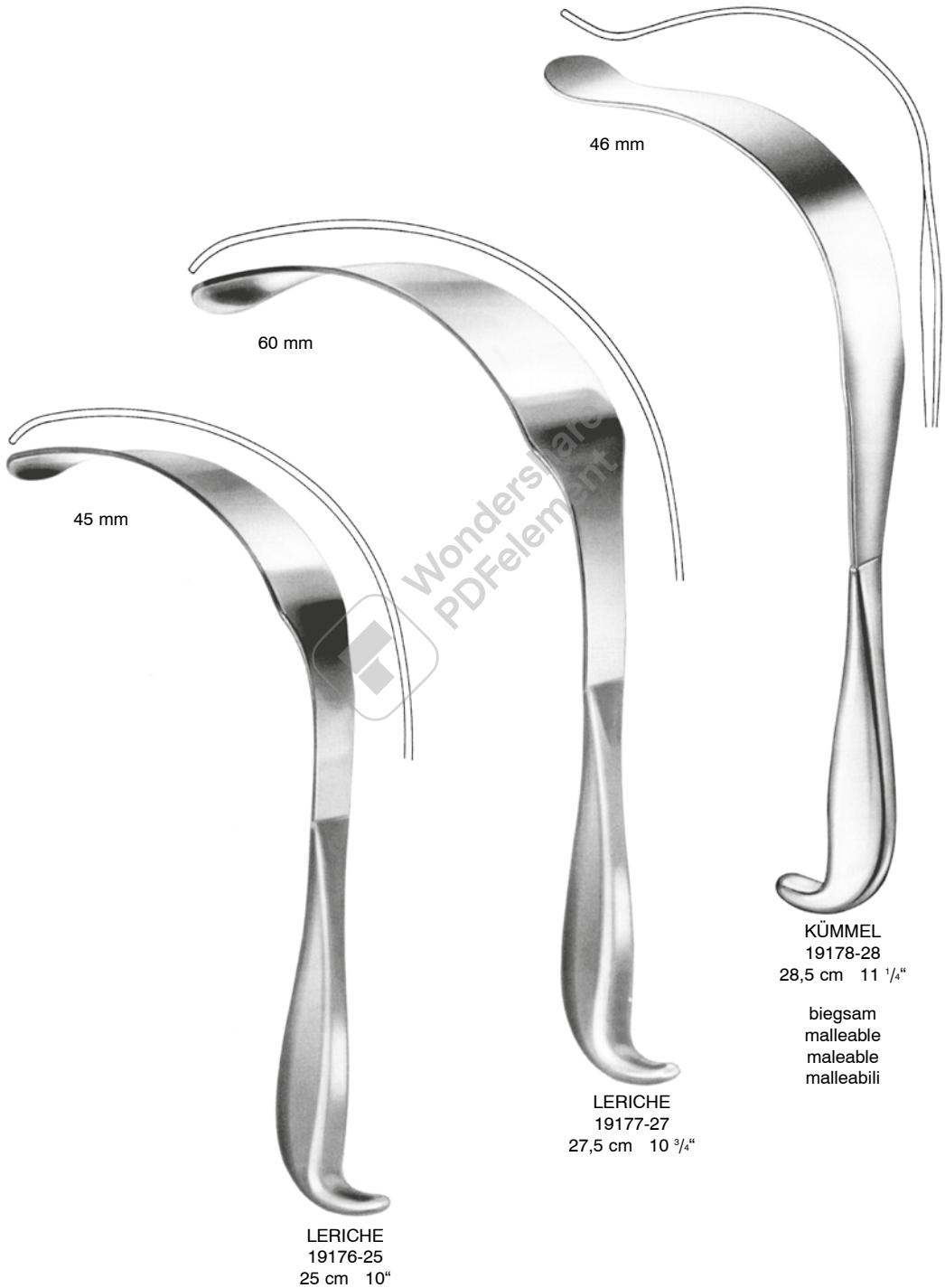
19174-17 17/25x200 mm
19174-25 25/30x280 mm
19174-37 37/45x300 mm
19174-40 40/50x300 mm



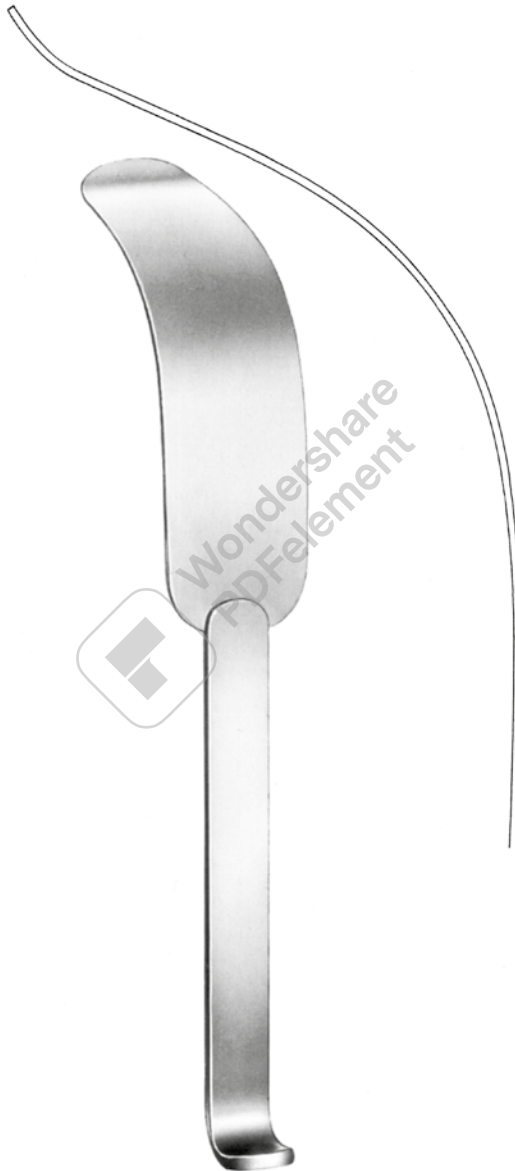
REVERDIN

19175-28
28 cm, 11"

Bauch- und Darmspatel
Abdominal and intestinal spatula
Separadores, espátula intestinal y abdominal
Divaricatori, spatole addominali e intestinali

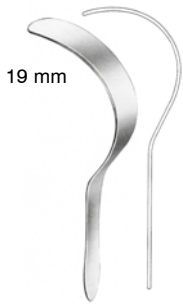


Bauchspatel
Abdominal Spatulas
Espátula abdominal
Spatola addominale



KÜMMEL
19179-28
31 cm 12 1/4"

Wundhaken
Retractors
Separadores
Divaricatori



19 mm

DEAYER
19180-19
19 cm, 7 1/2"



22 mm

DEAYER
19181-22
21,5 cm, 8 1/2"



25 mm

DEAYER
19181-25
23 cm, 9"



25 mm

DEAYER
19183-25
30 cm, 11 3/4"



25 mm

DEAYER
19185-25
33 cm, 13"



25 mm

DEAYER
19187-25
36 cm, 14"

Wundhaken
Retractors
Separadores
Divaricatori



38 mm

DEAVER
19187-38
30 cm, 11 ³/₄"



50 mm

DEAVER
19187-50
31 cm 12 ¹/₄"



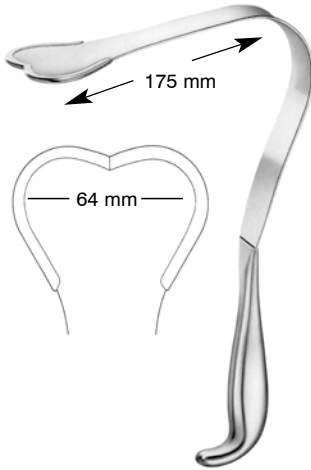
75 mm

DEAVER
19187-75
32 cm, 12 ³/₄"



DEAVER GRIP
19189-25 25x310 mm
19189-38 38x310 mm
19189-50 50x310 mm
19189-75 75x310 mm
31 cm 12 ¹/₄"

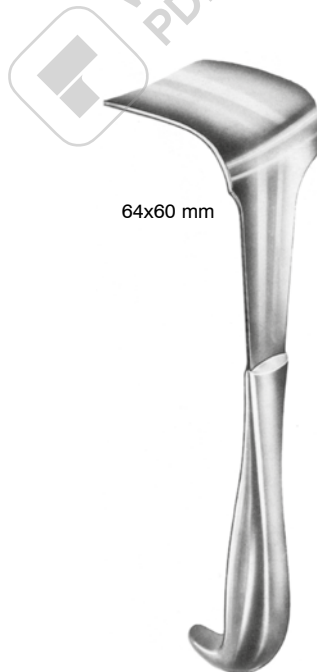
Wundhaken
Retractors
Separadores
Divaricatori



HARRINGTON-PEMBERTON
19190-64
29,5 cm 11 ³/₄"



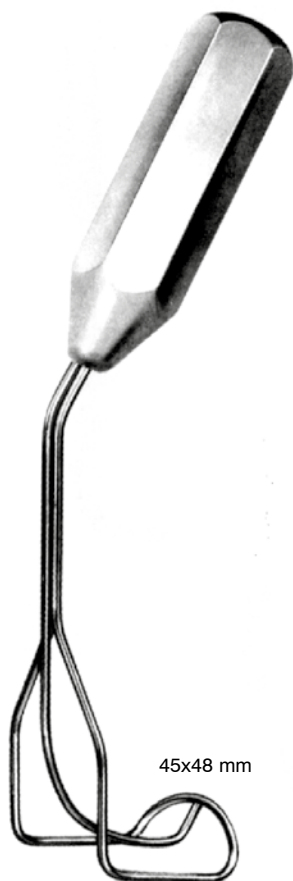
HARRINGTON
19191-25 25x230 mm
19191-40 40x320 mm
19191-62 62x320 mm



TUFFIER
19192-23
23 cm, 9"

Wundhaken
Retractors
Separadores
Divaricatori

30°
rechts
right
a la derecha
a destra



45x48 mm

COOLEY
19195-01
24,5 cm, 9 3/4"

30°
rechts, gerieft
right serrated
a la derecha, estriado
a destra, zigrinato



45x48 mm

COOLEY
19195-02
24,5 cm, 9 3/4"

30°
links
left
a la izquierda
a sinistra



24x48 mm

COOLEY
19195-03
25,5 cm, 10"

Aortahaken
Aorta Retractors
Separadores para aorta
Divaricatori per aorta



ROSS

flexibler Schaft
flexible shaft
vástago flexible
asta flessibile



19196-01
24 cm, 9 1/2"



19196-02
24,5 cm, 9 3/4"



19196-03
25 cm, 10"



19196-04
25,5 cm, 10"



19196-05
27 cm, 10 1/2"



19196-06
25,5 cm, 10"

Hauthäkchen

Nerve and wound hooks

Ganchos y ganchitos para nervios

Uncini per nervi e divaricatori fini



GRAEFE
19210-12
scharf
sharp
agudo
acuto



GRAEFE
19211-12
stumpf
blunt
romo
smusso



12 cm, 4 3/4"



GUTHRIE
19212-01



GUTHRIE
19212-02



scharf
sharp
agudo
acuto
A

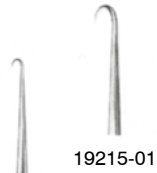


stumpf
blunt
romo
smusso
B

FRAZIER

A	19214-13	13 cm, 5"
A	19214-18	18 cm, 7"
B	19215-13	13 cm, 5"
B	19215-18	18 cm, 7"

Hauthäkchen
Nerve and wound hooks
Ganchos y ganchitos para nervios
Uncini per nervi e divaricatori fini



19215-01



19215-02



19215-03

LAHEY
12 cm, 4 3/4"



19216-01

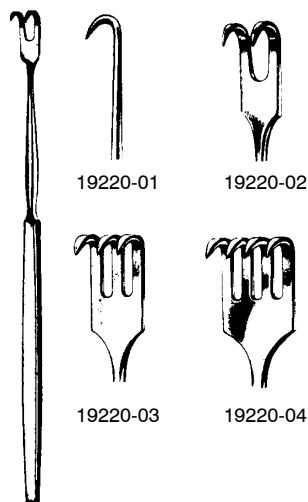
19216-02
2 mm19216-05
5 mm19216-07
7 mm19216-10
10 mm

JOSEPH
16 cm, 6 1/4"

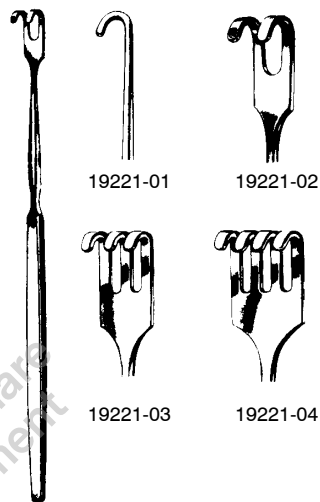
19217-03
3 mm19217-05
5 mm19217-07
7 mm

KLEINERT-KUTZ
13 cm, 5 1/8"

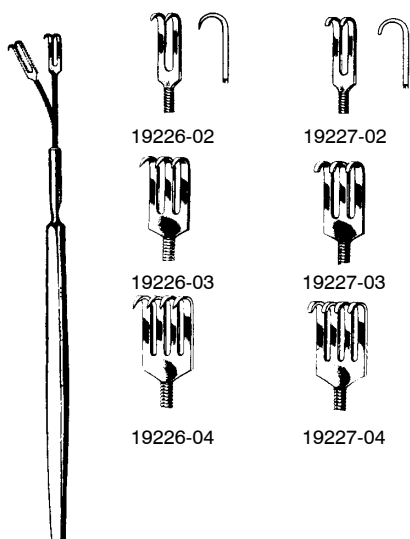
Hauthäkchen
 Nerve and wound hooks
 Ganchos y ganchitos para nervios
 Uncini per nervi e divaricatori fini



HADEO
 16 cm, 6 1/4"



HADEO
 16 cm, 6 1/4"

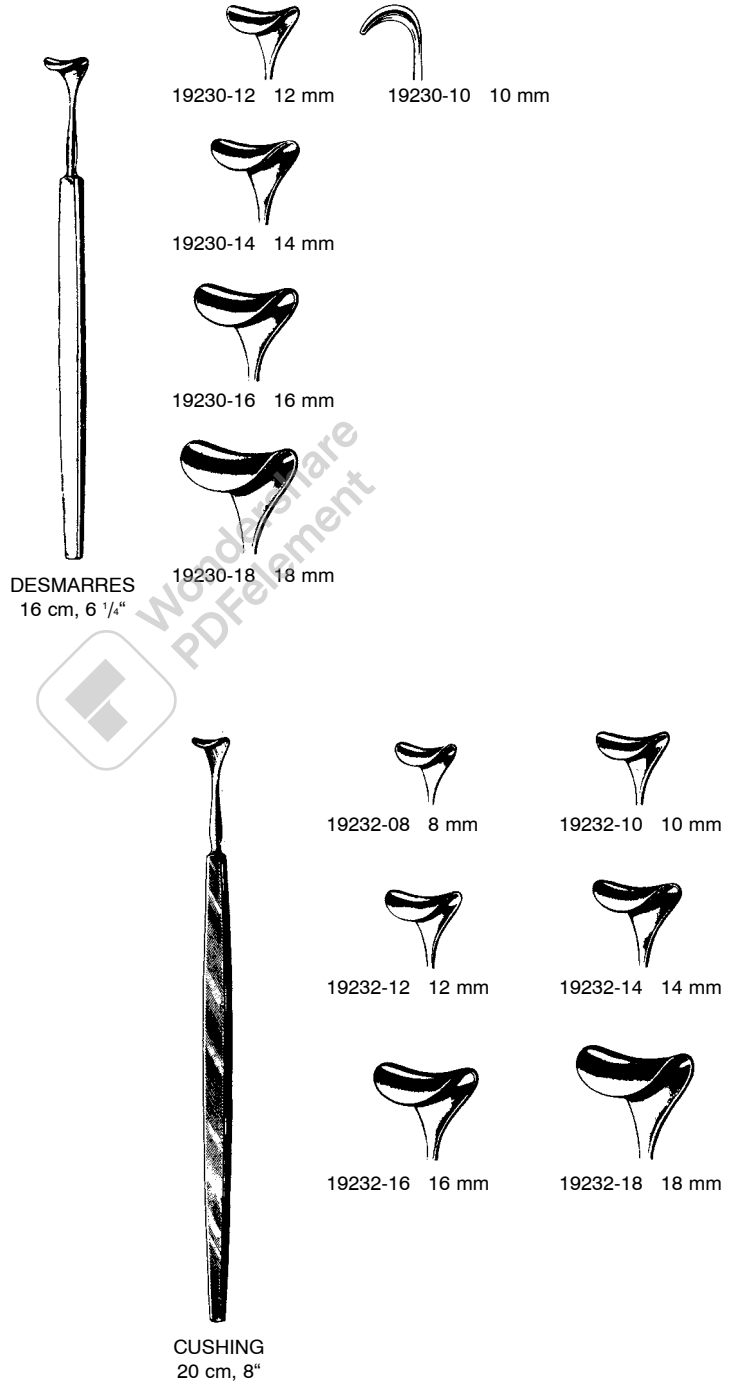


HADEO, flexibel
 16 cm, 6 1/4"



KLAPP
 17,5 cm, 6.9"

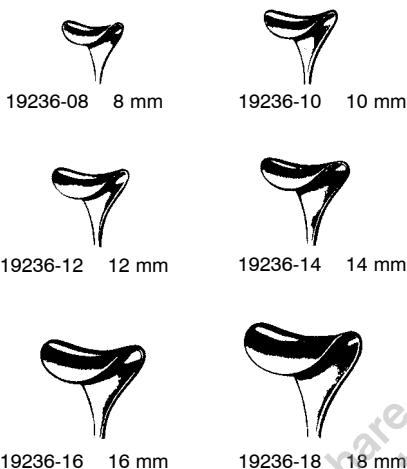
Sattelhäkchen
Saddle Hooks
Ganchos en forma de silla
Divaricatori a forma di sella



Sattelhäkchen
 Saddle Hooks
 Ganchos en forma de silla
 Divaricatori a forma di sella

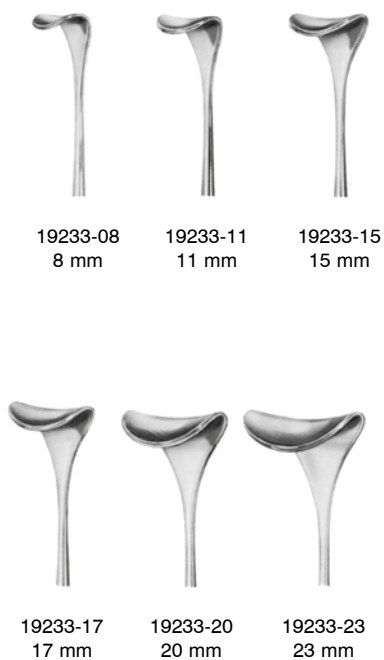


CUSHING
 24 cm, 9 1/2"



biegsam
 malleable
 maleable
 malleabile

GIL-VERNET
 24 cm, 9 1/2"



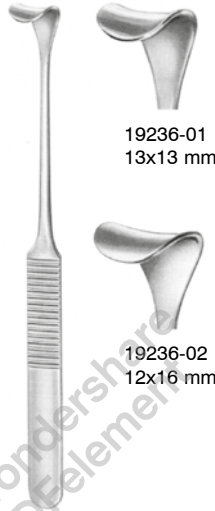
Wundhaken
Retractors
Separadores
Divaricatori



CUSHING
19234-20
20 cm, 8"



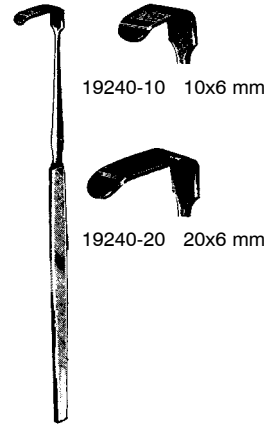
CUSHING
19235-21
21,5 cm, 8 1/2"



19236-01
13x13 mm

19236-02
12x16 mm

KÖNIG
18 cm, 7"



19240-10 10x6 mm

19240-20 20x6 mm

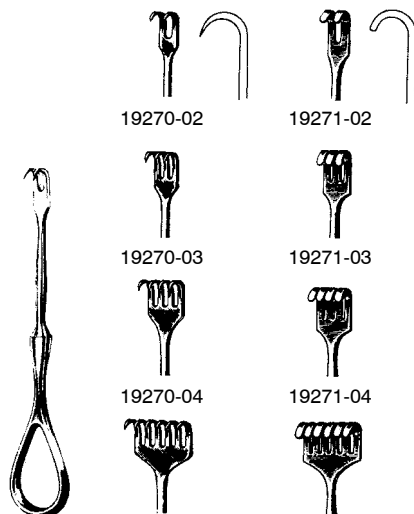
SENN-GREEN
15 cm, 6"



19250-16
16x6 mm

19250-24
24x6 mm

LANGENBECK-GREEN
16 cm, 6 1/4"



19270-02

19271-02

19270-03

19271-03

19270-04

19271-04

19270-06

19271-06

VOLKMANN
11,5 cm, 4 1/2"

Wundhaken
Retractors
Separadores
Divaricatori



19280-01



19280-02



19280-03



19280-04



19280-06

scharf
sharp
agudo
acuto

19281-01



19281-02



19281-03



19281-04



19281-06

stumpf
blunt
romo
smusso

19282-02



19282-03



19282-04



19282-06

halbscharf
semi-sharp
medio romo
mezzo smussoVOLKMANN
21,5 cm, 8 1/2"

Wundhaken
Retractors
Separadores
Divaricatori



19296-01



19296-02



19296-03



19296-04



19296-06



19296-08



scharf
sharp
agudo
acuto



19297-01



19297-02



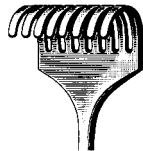
19297-03



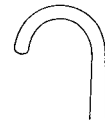
19297-04



19297-06



19297-08

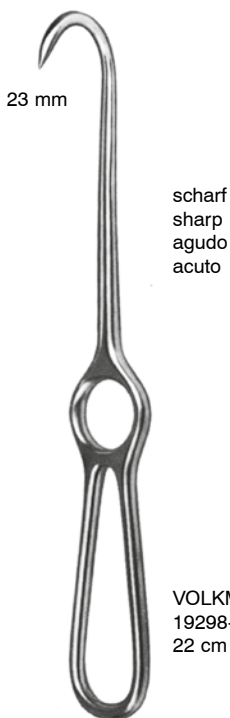


stumpf
blunt
romo
smusso

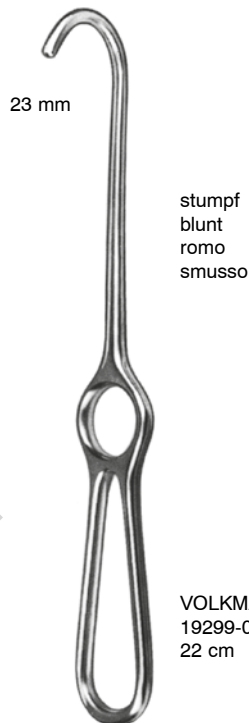


KOCHER
22 cm, 8 3/4"

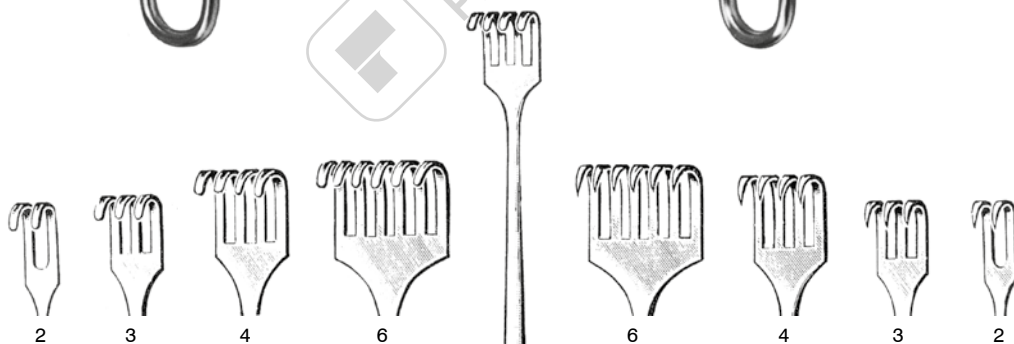
Wundhaken, Knochenhaken
 Retractors, Bone Retractors
 Separadores, Separadores oseos
 Divaricatori, Divaricatori per ossa



VOLKMANN
 19298-01
 22 cm 8 3/4"



VOLKMANN
 19299-01
 22 cm 8 3/4"



stumpf
blunt
romo
smusso

- 19301-02 8x 8 mm
- 19301-03 8x13 mm
- 19301-04 8x18 mm
- 19301-06 8x28 mm

scharf
sharp
agudo
acuto

- 19300-02 8x 8 mm
- 19300-03 8x13 mm
- 19300-04 8x18 mm
- 19300-06 8x28 mm

MURPHY
 19,4 cm 7 5/8"

Wundhaken
Retractors
Separadores
Divaricatori



MEYERDING
18 cm, 7"



19302-01 18x7 mm



19302-04 7x4 mm



19302-02 16x5 mm



19302-05 10x3 mm



19302-03 7x4 mm



19302-06 10x4 mm



28x6 mm

LAHEY
19304-19
19 cm, 7 1/2"



12x14 mm



LITTLE
19306-20
20 cm, 8"



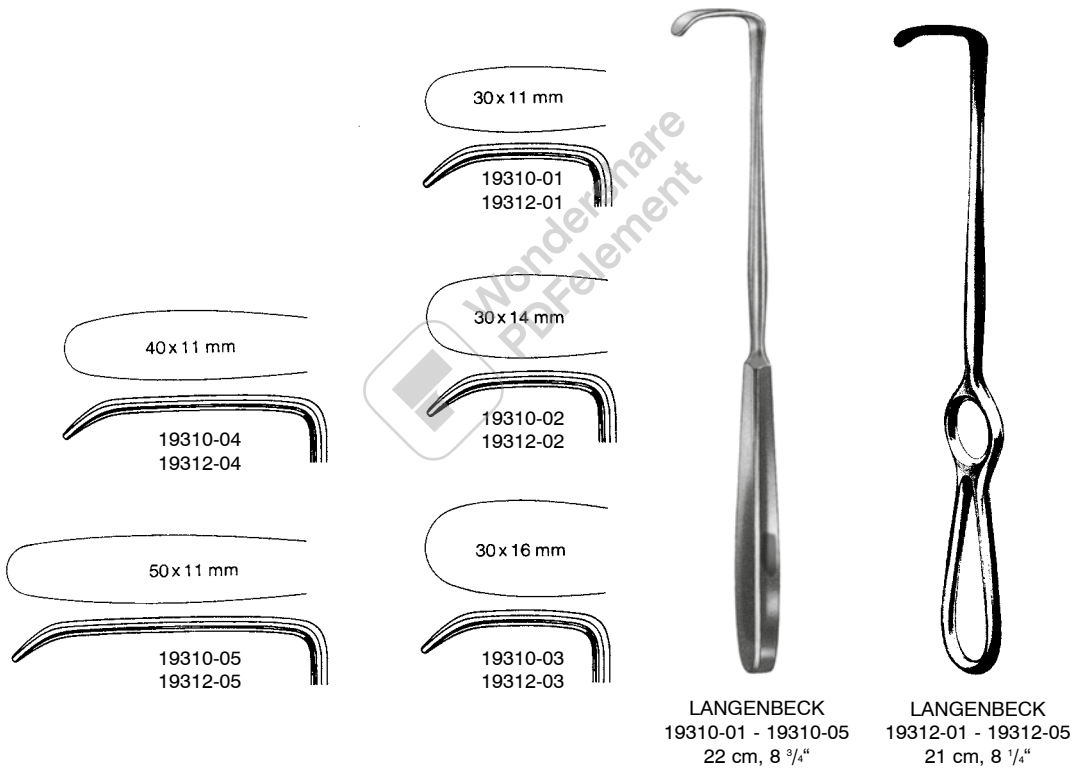
19307-01



19307-02

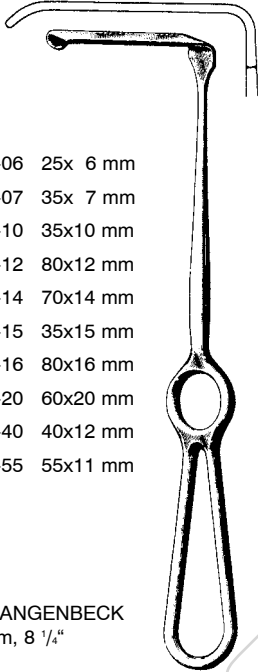
STRANDELL-STILLE
17 cm 6 3/4"

Wundhaken
Retractors
Separadores
Divaricatori

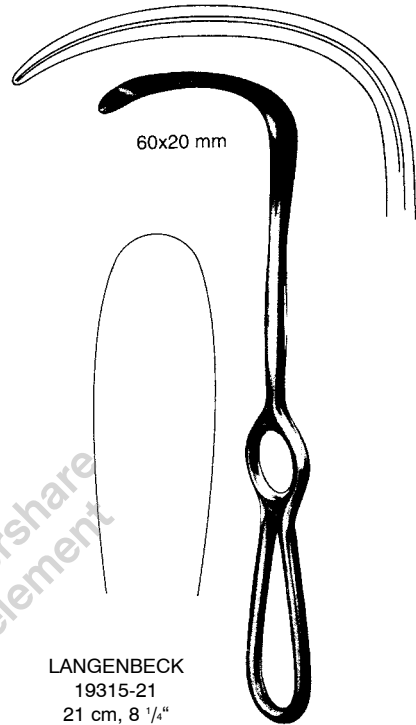


Wundhaken
Retractors
Separadores
Divaricatori

- 19315-06 25x 6 mm
- 19314-07 35x 7 mm
- 19314-10 35x10 mm
- 19314-12 80x12 mm
- 19314-14 70x14 mm
- 19314-15 35x15 mm
- 19314-16 80x16 mm
- 19314-20 60x20 mm
- 19330-40 40x12 mm
- 19330-55 55x11 mm



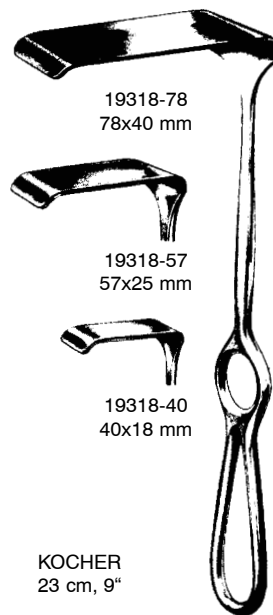
KOCHER-LANGENBECK
21 cm, 8 1/4"



LANGENBECK
19315-21
21 cm, 8 1/4"



LANGENBECK
19317-21
21 cm, 8 1/4"




KOCHER
23 cm, 9"

Wondershare
PDFelement


Wundhaken
Retractors
Separadores
Divaricatori



19344-14
14x17 mm
21,5 cm, 8 1/2"



19344-20
20x22 mm
22 cm, 8 3/4"



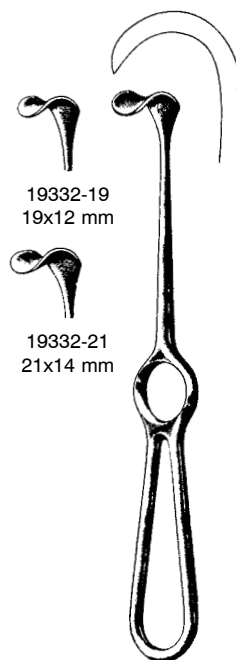
19344-26
26x30 mm
23,5 cm, 9 1/4"



MIDDLEDORPF
19344-14 - 19344-26



KOCHER
19340-10 40x10 mm
19340-15 40x15 mm
19340-20 40x20 mm
22 cm, 8 3/4"



19332-19
19x12 mm

19332-21
21x14 mm

KOCHER
19332-19 - 19332-21
19 cm, 7 1/2"



MIDDLEDORPF
19345-01 45x45 mm
25,5 cm, 10"



19345-02
45x50 mm



19345-03
55x70 mm



GREEN
19348-22
22 cm, 8 3/4"

Wundhaken
Retractors
Separadores
Divaricatori

35 x 8 mm



ZENKER
19350-35
25 cm, 10"

60 x 12 mm



ZENKER
19350-60
26 cm, 10 1/4"

75 x 12 mm



ZENKER
19350-70
27,5 cm, 10.8"

Wondershare
PDFelement

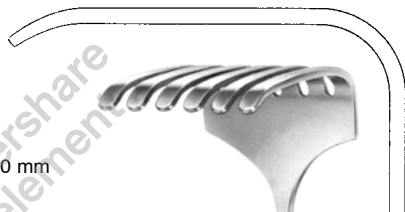
Wundhaken
Retractors
Separadores
Divaricatori



19364-50 45x50 mm



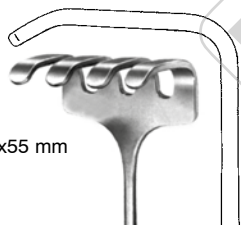
19364-60 50x60 mm



19364-70 70x70 mm

ISRAEL
19364-40 40x40 mm
25 cm, 10"

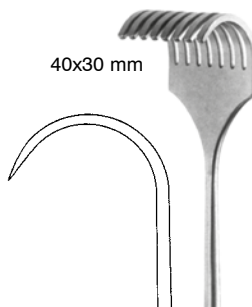
Wondershare PDFElement



35x55 mm

OLLIER

19360-04 22,5 cm, 8.9"



40x30 mm

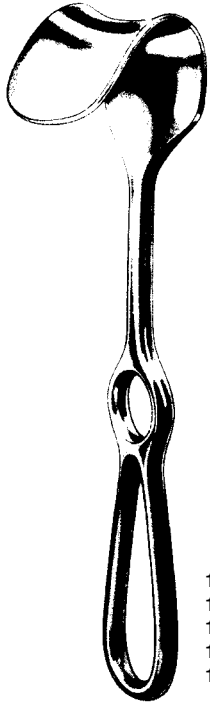
spitz
sharp
agudo
acuto

stumpf
blunt
romo
smusso

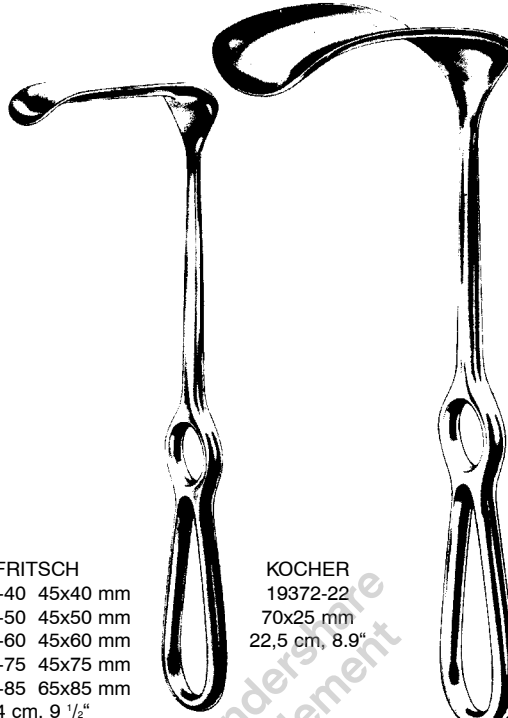
KOERTE

19366-08 23,5 cm, 9 1/4" 19367-08

Wundhaken
Retractors
Separadores
Divaricatori



FRITSCH
19370-40 45x40 mm
19370-50 45x50 mm
19370-60 45x60 mm
19370-75 45x75 mm
19370-85 65x85 mm
24 cm, 9 1/2"



KOCHER
19372-22
70x25 mm
22,5 cm, 8.9"

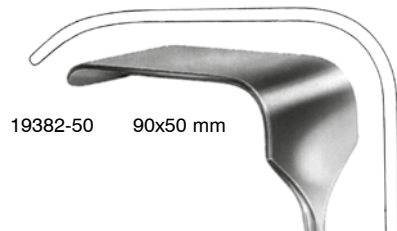


KOCHER
19374-45 80x45 mm
19374-55 80x55 mm
19374-65 80x65 mm
25 cm, 10"

50x85 mm



DOYEN
19378-25
25 cm, 10"



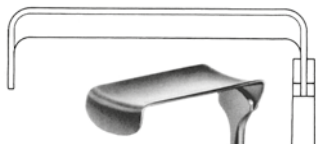
19382-50 90x50 mm

19380-35 95x35 mm
19380-50 120x50 mm
19381-50 150x50 mm

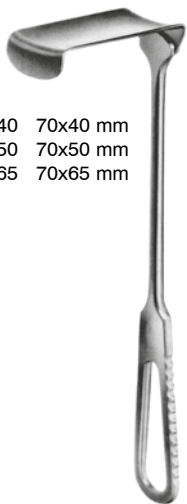


MIKULICZ
26 cm, 10 1/4"

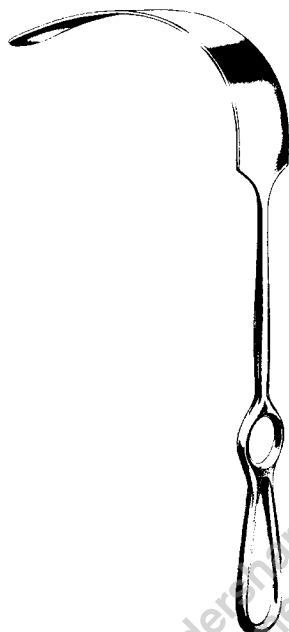
Wundhaken
Retractors
Separadores
Divaricatori



- 19388-40 70x40 mm
- 19388-50 70x50 mm
- 19388-65 70x65 mm



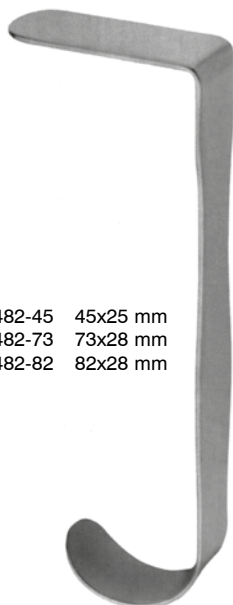
MORRIS
24,5 cm
9 3/4"



KELLY
19385-38 160x38 mm
19385-57 160x57 mm
27 cm, 10 1/2"

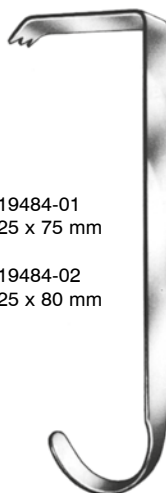


SIMON
19480-22 115x22 mm
19480-27 115x27 mm
28 cm, 11"



- 19482-45 45x25 mm
- 19482-73 73x28 mm
- 19482-82 82x28 mm

HEANEY
27 cm, 10 1/2"



- 19484-01
25 x 75 mm
- 19484-02
25 x 80 mm

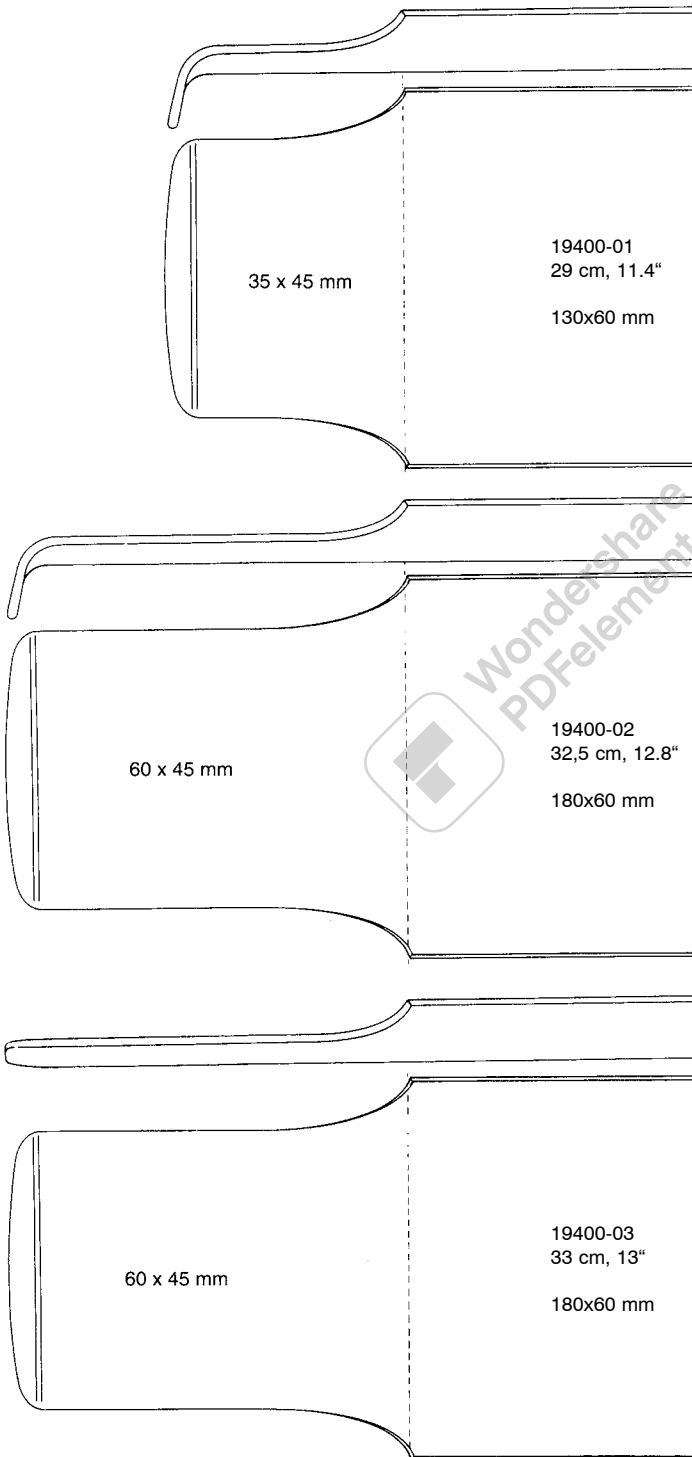
HIBBS
24 cm, 9 1/2"



125x37 mm

SAUERBRUCH
19492-25
25 cm, 10"

Pelvis-Haken
Pelvis retractor
Retractor de pelvis
Divaricatori pelvici



ST. MARKS
19400-01 19400-03

Wundhaken, Scapulahaken
 Retractors, Scapula Retractors
 Separadores, Separadores para escápula
 Divaricatori, Divaricatori per scapola

19490-65 115x65 mm
 19490-43 108x43 mm
 19490-22 82x22 mm



CORYLLOS (Thorax)
 24 cm, 9 1/2"

19494-45 45x15 mm
 19494-60 60x23 mm
 19494-75 75x20 mm



SAUERBRUCH
 22,5 cm, 8.9"

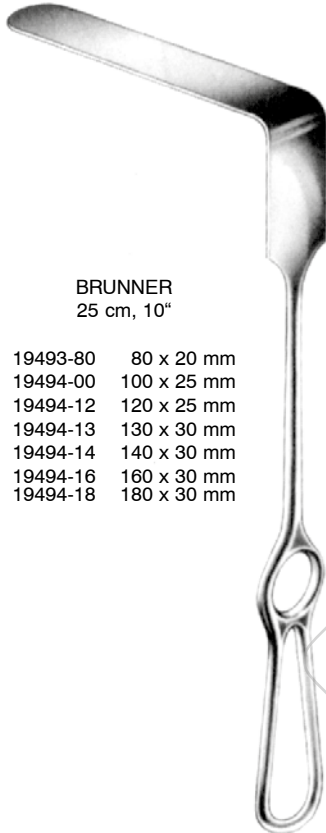


DAVIDSON
 19496-50 75x50 mm



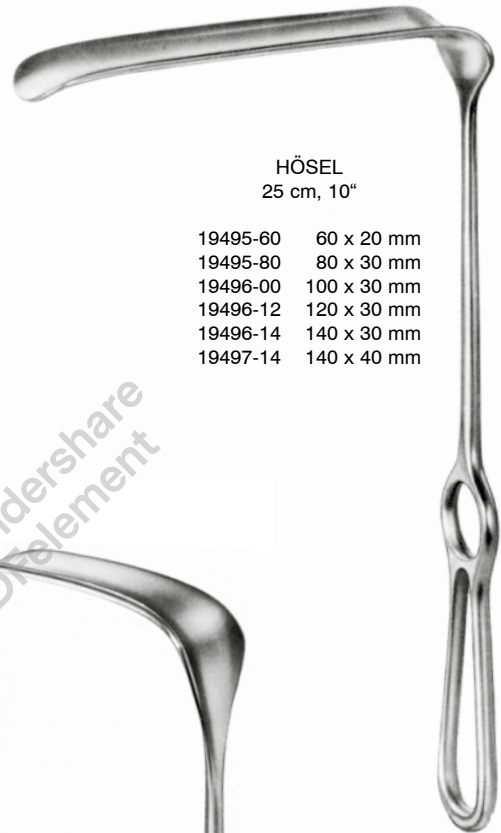
DAVIDSON
 19496-90 75x90 mm

Wundhaken
Retractors
Separadores
Divaricatori



BRUNNER
25 cm, 10"

19493-80	80 x 20 mm
19494-00	100 x 25 mm
19494-12	120 x 25 mm
19494-13	130 x 30 mm
19494-14	140 x 30 mm
19494-16	160 x 30 mm
19494-18	180 x 30 mm



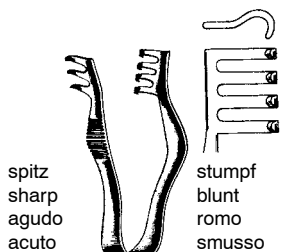
HÖSEL
25 cm, 10"

19495-60	60 x 20 mm
19495-80	80 x 30 mm
19496-00	100 x 30 mm
19496-12	120 x 30 mm
19496-14	140 x 30 mm
19497-14	140 x 40 mm

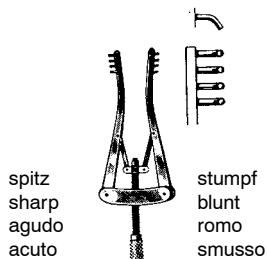
DOYEN-STILLE
25 cm, 10"

19498-01	97 x 29 mm
19498-02	101 x 31 mm
19498-03	127 x 52 mm

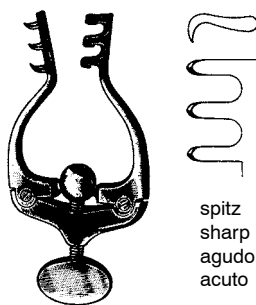
Wundsperrer, Kieferhöhlensperrer
 Retractors, Antrum Retractor
 Separadores, Separadores para seno maxilar
 Divaricatori, Divaricatori per seno mascellare



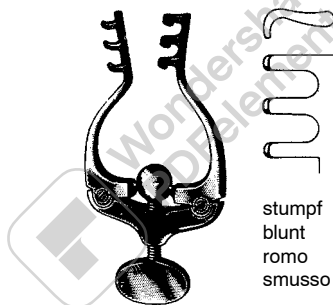
FINSEN
 19610-07 7 cm, 2 3/4" 19611-07



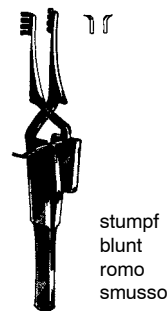
ALM
 19620-07 7 cm, 2 3/4" 19621-07
 19620-10 10 cm, 4" 19621-10



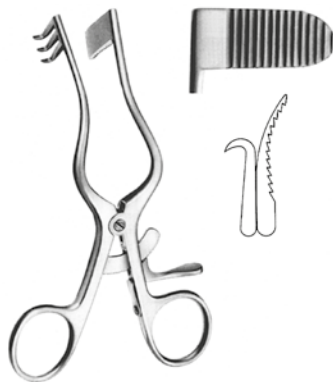
JANSSEN
 19630-10
 10 cm, 4"



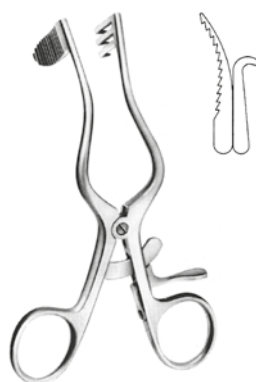
JANSSEN
 19631-10
 10 cm, 4"



HOLZHEIMER
 19634-10 19635-10
 10 cm, 4"

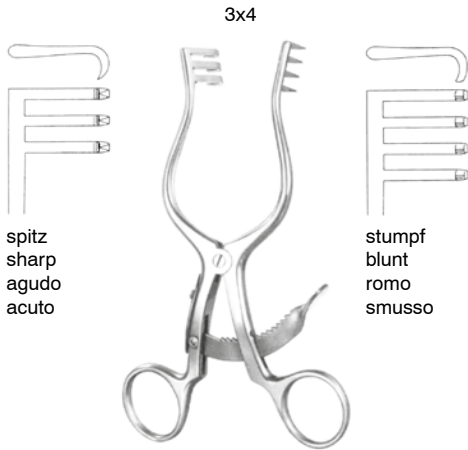


PERKINS
 19636-14
 13 cm, 5 1/8"

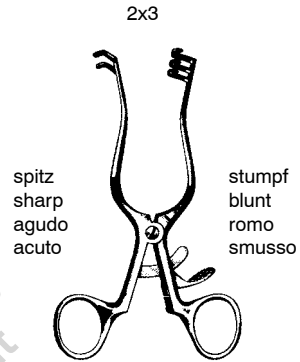


PERKINS
 19637-14
 13 cm, 5 1/8"

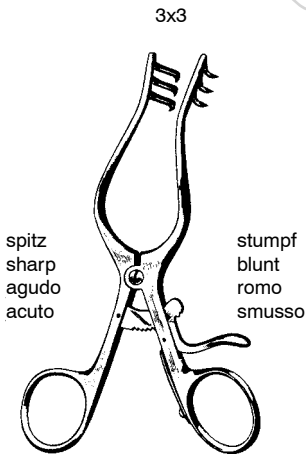
Wundsperrer
Retractors
Separadores
Divaricatori



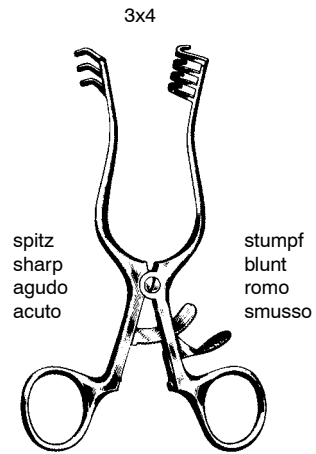
SCALP-CONTOUR
19640-14 - 19641-14
13,5 cm, 5 1/4"



WEITLANER
19650-10 19651-10
11,5 cm, 4 1/2"

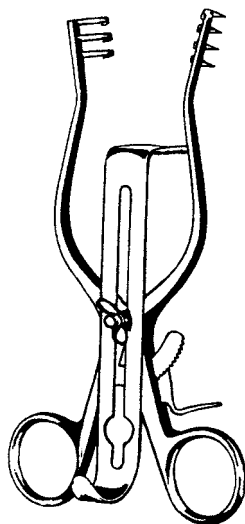


WEITLANER-WULLSTEIN
19654-13 19655-13
13 cm, 5 1/8"

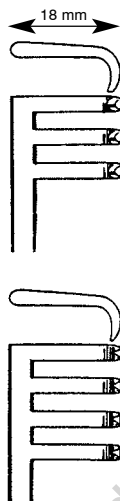


WEITLANER
19670-14 14,0 cm, 5 1/2" 19671-14
19670-16 16,5 cm, 6 1/2" 19671-16
19670-20 20,0 cm, 8" 19671-20
19670-24 24,0 cm, 9 1/2" 19671-24

Wundsperrer
Retractors
Separadores
Divaricatori



HENLEY
19675-00 - 19677-32
16,5 cm, 6 1/2"

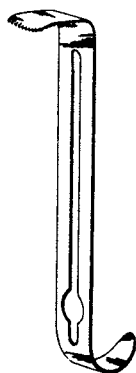


19675-00 komplett, stumpf, 3x4 Z. und 3 Valven
19675-00 complete, blunt, 3x4 teeth and 3 blades
19675-00 completo, romo, 3x4 dientes y 3 valvas
19675-00 completo, smusso, 3x4 d. e 3 valve

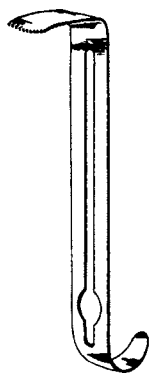
19676-00 komplett, scharf, 3x4 Z. und 3 Valven
19676-00 complete, sharp, 3x4 teeth and 3 blades
19676-00 complete, agudo, 3x4 dientes y 3 valvas
19676-00 completo con retr. acuto 3x4 d. e 3 valve

19678-05 Retraktor allein, stumpf 3x4 Zähne
19678-05 Retractor only, blunt 3x4 teeth
19678-05 Separador solo, romo, 3x4 dientes
19678-05 Retrattore solo, smusso 3x4 denti

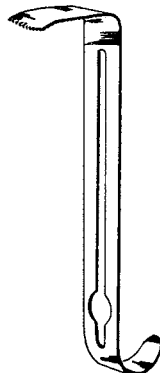
19678-06 Retraktor allein, spitz 3x4 Zähne
19678-06 Retractor only, sharp 3x4 teeth
19678-06 Separador solo, agudo, 3x4 dientes
19678-06 Retrattore solo, acuto 3x4 denti



19677-19
16x19 mm
5/8" x 3/4"



19677-25
16x25 mm
5/8" x 1"



19677-32
16x32 mm
5/8" x 1 1/4"

Wundsperrer
Retractors
Separadores
Divaricatori

PLESTER
19672-11 11 cm, 4 $\frac{3}{8}$ "
stumpf - blunt - romo - smusso



PLESTER
19673-11 11 cm, 4 $\frac{3}{8}$ "
stumpf - blunt - romo - smusso



MOLLISON
19674-15 15 cm, 6"
scharf - sharp - agudo - acuto

Wondershare
PDFelement

WULLSTEIN
19675-13 13 cm, 5 $\frac{1}{8}$ "
stumpf - blunt - romo - smusso

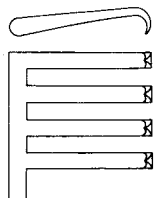
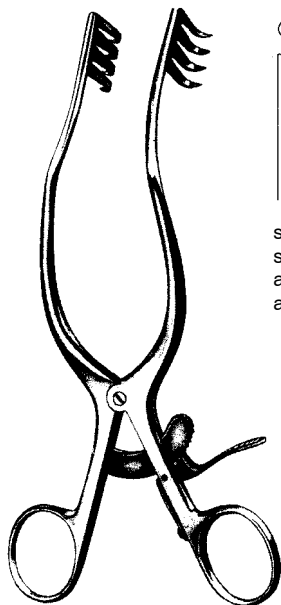


PLESTER
19677-13 13 cm, 5 $\frac{1}{8}$ "
scharf - sharp - agudo - acuto



MAYO-ADAMS
19678-16 16,5 cm, 6 $\frac{1}{2}$ "
stumpf - blunt - romo - smusso

Wundsperrer
Retractors
Separadores
Divaricatori



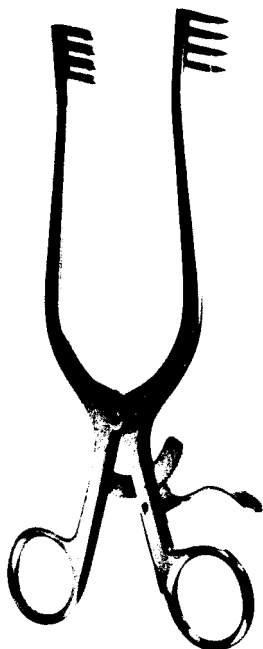
spitz
sharp
agudo
acuto

ANDERSON ADSON
19679-20 19,5 cm, 7 3/4"



stumpf
blunt
romo
smusso

NORFOLK / NORWICH
19679-22 22 cm, 8 3/4"



spitz
sharp
agudo
acuto

ADSON
19680-19 19 cm, 7 1/2" 19681-19

stumpf
blunt
romo
smusso



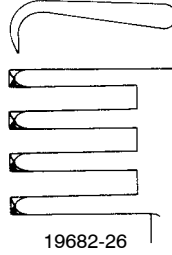
stumpf
blunt
romo
smusso

TRAVERS
19681-21 21,5 cm, 8 1/2"

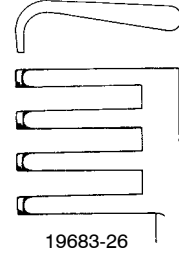
Wundsperrer
Retractors
Separadores
Divaricatori



spitz
sharp
agudo
acuto



19682-26



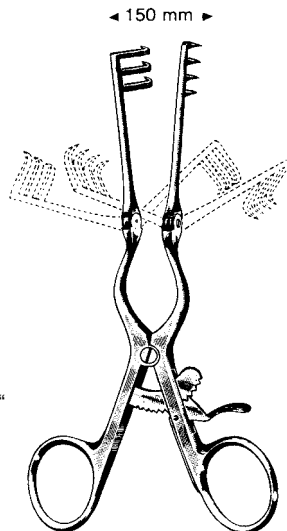
stumpf
blunt
romo
smusso

19683-26

ADSON
19682-26 - 19683-26
26,5 cm, 10 1/2"

- 19684-14 14 cm, 5 1/2"
- 19684-16 16 cm, 6 1/4"
- 19684-20 20 cm, 8"
- 19684-26 26 cm, 10 1/4"

spitz
sharp
agudo
acuto

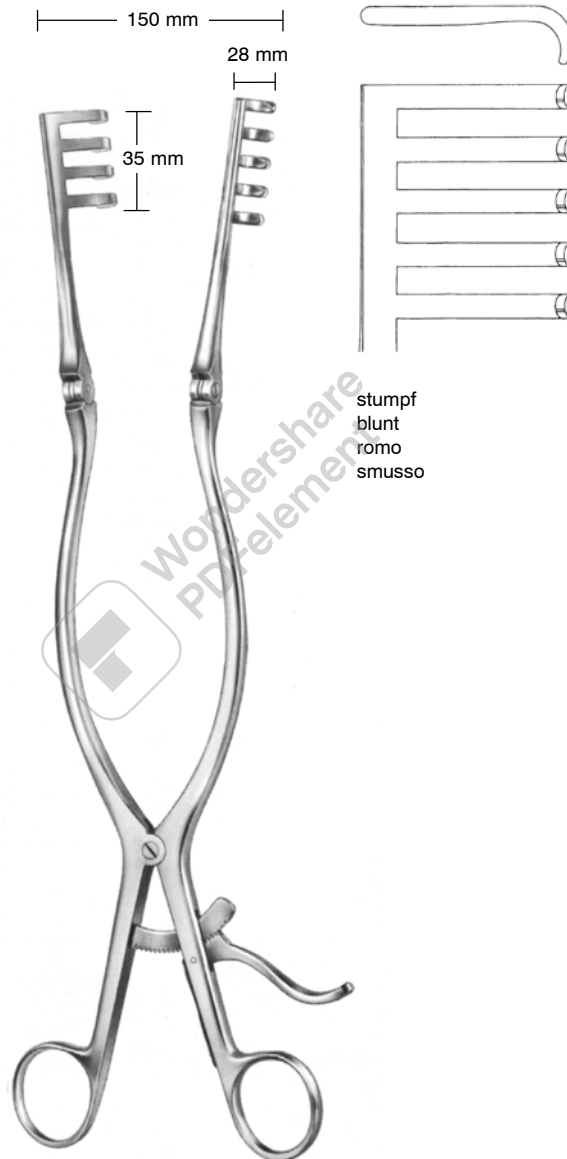


ADSON

- 19685-14 14 cm, 5 1/2"
- 19685-16 16 cm, 6 1/4"
- 19685-20 20 cm, 8"
- 19685-26 26 cm, 10 1/4"

stumpf
blunt
romo
smusso

Wundsperrer
Retractors
Separadores
Divaricatori

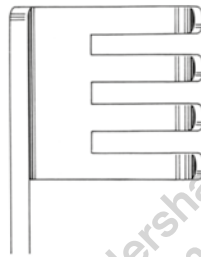


ADSON
19686-32
32 cm, 12 3/4"

Wundsperrer
Retractors
Separadores
Divaricatori

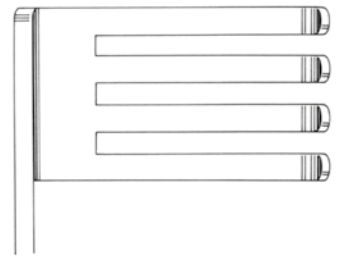


BECKMAN-ADSON
31 cm, 12 1/4"



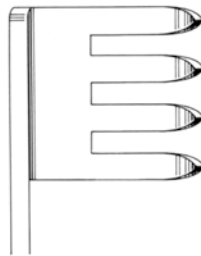
19687-01
25 x 31 mm

stumpf
blunt
romo
smusso



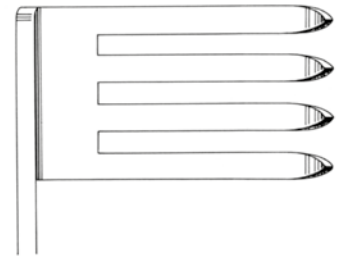
19688-01
45 x 27 mm

stumpf
blunt
romo
smusso



19687-02
25 x 31 mm

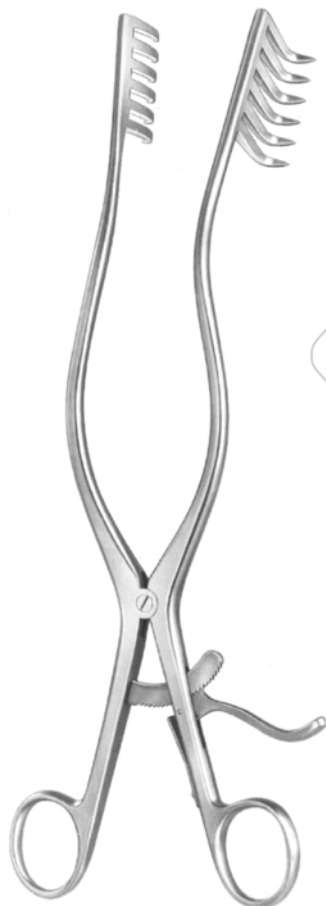
scharf
sharp
agudo
acuto



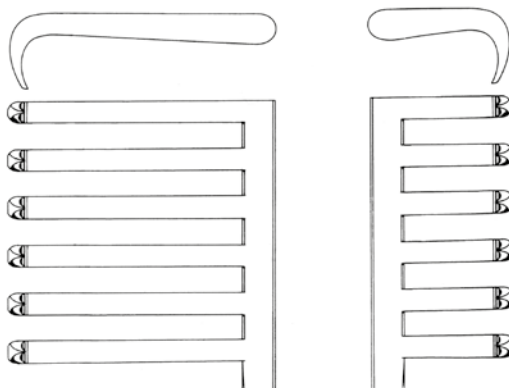
19688-02
45 x 27 mm

scharf
sharp
agudo
acuto

Wundsperrer
Retractors
Separadores
Divaricatori

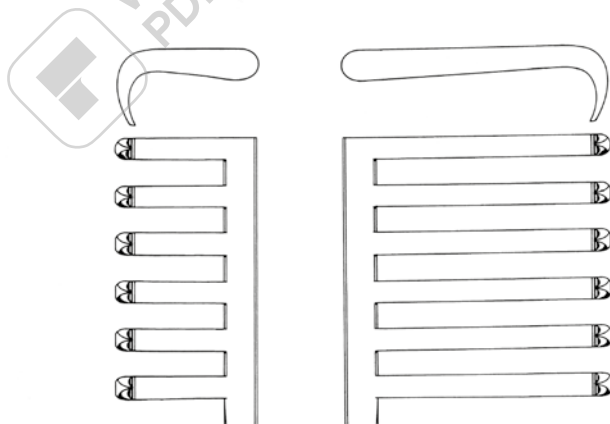


MARTIN
28,5 cm, 11 1/4"



19689-01
6x6 Zähne

scharf, lange Zähne links
sharp, long teeth on left side
agudo, dientes largos a la izquierda
acuto, denti lunghe a sinistra

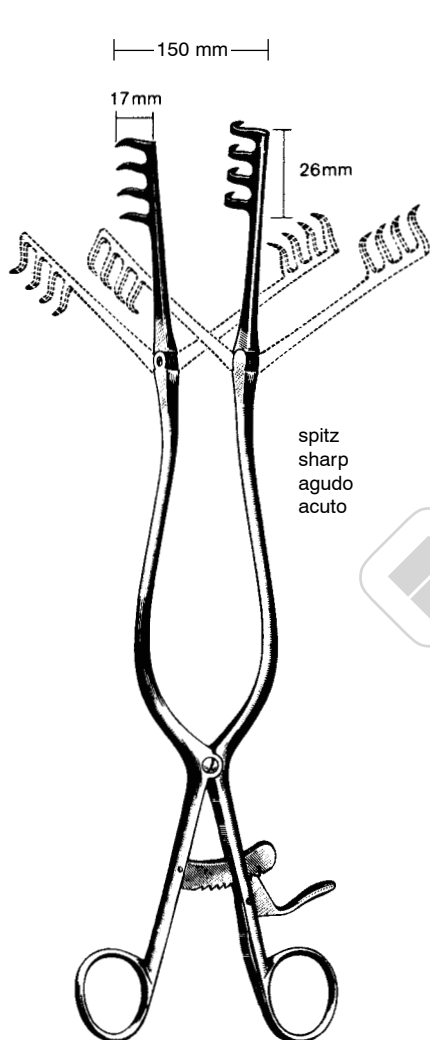


19689-02
6x6 Zähne

scharf, lange Zähne rechts
sharp, long teeth on right side
agudo, dientes largos a la derecha
acuto, denti lunghe a destra



Wundsperrer
Retractors
Separadores
Divaricatori



BECKMANN
19690-31
31 cm, 12 1/4"



BECKMANN-EATON
19692-32
32 cm, 12 3/4"

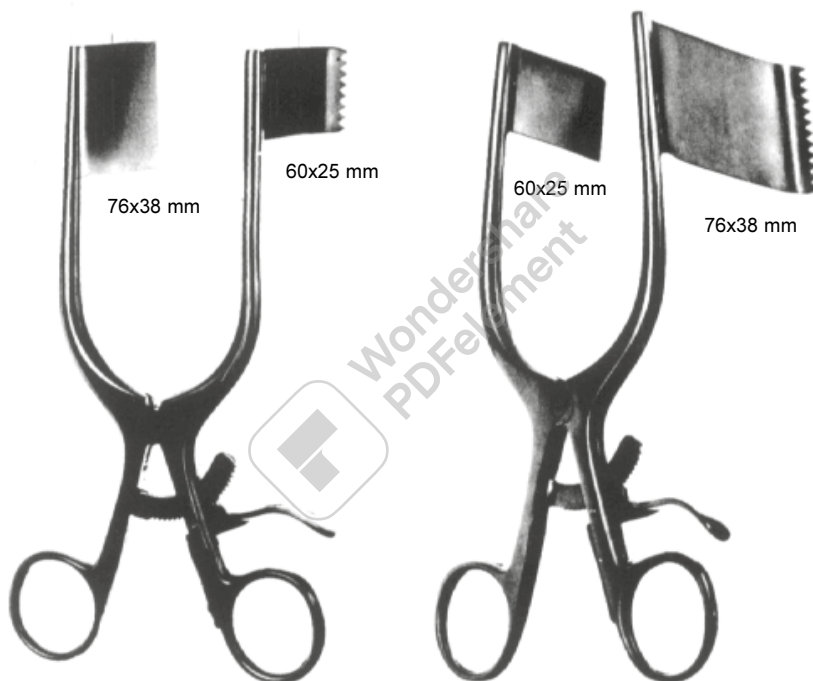
Wundhaken
Retractors
Separadores
Divaricatori



19694-01	20 cm, 8"	50 x 16 mm
19694-02	23 cm, 9"	75 x 25 mm
19694-03	24 cm, 9 1/2"	90 x 50 mm

MEYERDING

Hemilaminectomiespreizer
 Hemilaminectomy Retractor
 Separadores para hemilaminectomía
 Divaricatori per emilaminectomia



DARLING
 19696-18 18 cm, 7"

links
 left
 a la izquierda
 a sinistra

DARLING
 19698-18 18 cm, 7"

rechts
 right
 a la derecha
 a destra

Cervicalspreizer
Cervical Retractor
Separador cervical
Divaricatore cervicale



CLOWARD
25 cm, 10"

spitz
sharp
agudo
acuto

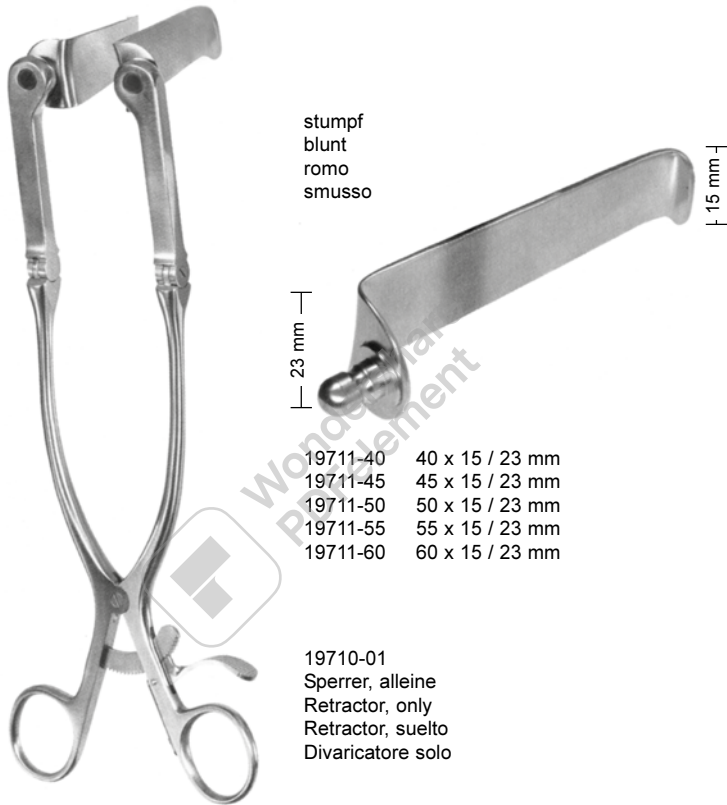


19710-40	40 x 15 / 23 mm
19710-45	45 x 15 / 23 mm
19710-50	50 x 15 / 23 mm
19710-55	55 x 15 / 23 mm
19710-60	60 x 15 / 23 mm

19710-01
Sperrer, alleine
Retractor, only
Retractor, suelto
Divaricatore solo

19710-00
Sperrer komplett mit 5 Valven spitz
Retractor complete with 5 blades sharp
Separador completo con 5 valvas agudas
Divaricatore completo con 5 valve acute

Cervicalspreizer
Cervical Retractor
Separador cervical
Divaricatore cervicale



CLOWARD
25 cm, 10"

19712-00
Sperrer komplett mit 5 Valven stumpf
Retractor complete with 5 blades blunt
Separador completo con 5 valvas romas
Divaricatore completo con 5 valve smusse

Cervicalspreizer
Cervical Retractor
Separador cervical
Divaricatore cervicale

spitz
sharp
agudo
acuto



19710-40	40 x 15 / 23 mm
19710-45	45 x 15 / 23 mm
19710-50	50 x 15 / 23 mm
19710-55	55 x 15 / 23 mm
19710-60	60 x 15 / 23 mm

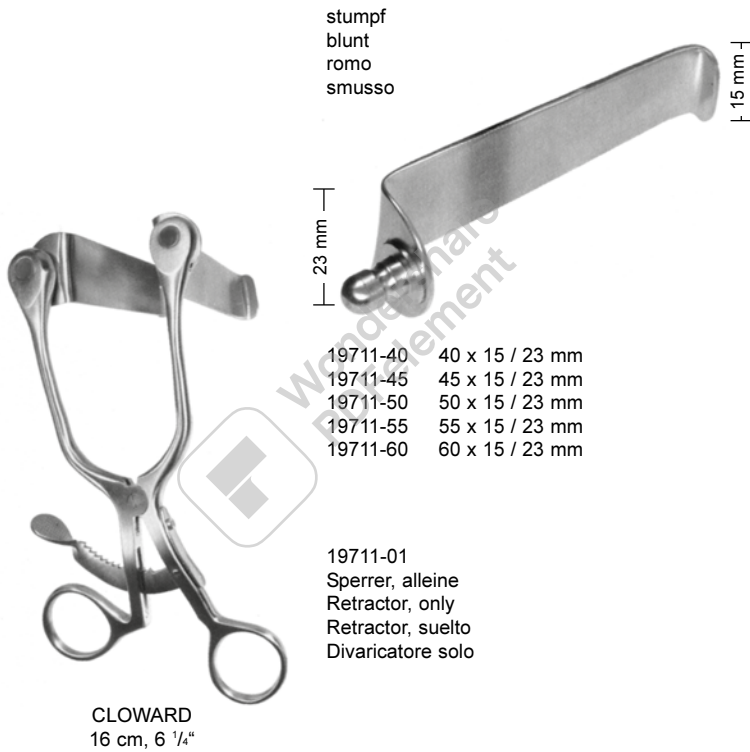


CLOWARD
16 cm, 6 1/4"

19711-01
Sperrer, alleine
Retractor, only
Retractor, suelto
Divaricatore solo

19711-00
Sperrer komplett mit 5 Valven spitz
Retractor complete with 5 blades sharp
Separador completo con 5 valvas agudas
Divaricatore completo con 5 valve acute

Cervicalspreizer
Cervical Retractor
Separador cervical
Divaricatore cervicale



19713-00
Sperrer komplett mit 5 Valven stumpf
Retractor complete with 5 blades blunt
Separador completo con 5 valvas romas
Divaricatore completo con 5 valve smusse

Cervicalspreizer
Cervical Retractor
Separador cervical
Divaricatore cervicale

90 mm, 3 1/2"



CASPAR
19721-15
165 mm, 5 1/2"

Sperrer, alleine
Retractor, only
Retractor, suelto
Divaricatore solo

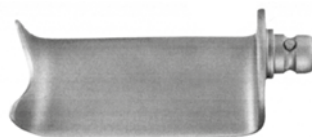


19726-01

Blätter-Wechselpinzette
Blade ejector
Pinza para cambiar hojas
Pinze per cambiare valve

19721-00
Sperrer komplett mit 5 Valven stumpf
Retractor complete with 5 blades blunt
Separador completo con 5 valvas romas
Divaricatore completo con 5 valve smusse

19738-45	45 x 23 mm
19738-50	50 x 23 mm
19738-55	55 x 23 mm
19738-60	60 x 23 mm
19738-65	65 x 23 mm



Lumbal-Wundspreizer
Lumbal Retractors
Separadores lumbales autoestáticos
Divaricatori autostatici lombari



19745-40
40 mm, 1 1/2"



19745-45
45 mm, 1 3/4"



19745-60
60 mm, 2 1/4"



19745-50
50 mm, 2"



19745-65
65 mm, 2 1/2"



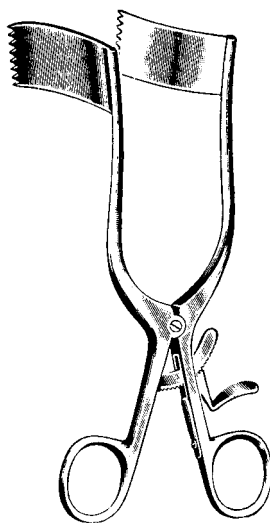
19745-55
55 mm, 2 1/8"



19745-70
70 mm, 2 3/4"

CASPAR
19744-00
komplett mit 7 Blätter
compl. incl. 7 blades
completo con 7 valvas
complete di 7 valve

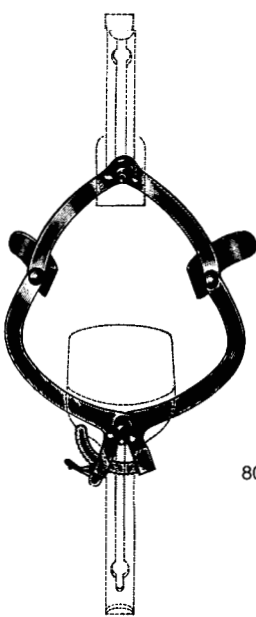
19744-17
ohne Blätter
without blades
sin valvas
senza valve



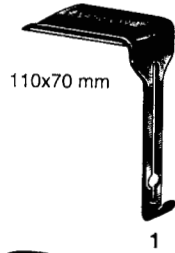
MEYERDING
17 cm, 6 3/4"

19748-01 2,5 x 3,2 cm
19748-02 2,5 x 5,4 cm
19748-03 1,9 x 6,0 cm
19748-04 2,5 x 6,0 cm

Bauchdeckenhalter
 Abdominal Retractors
 Separadores abdominales
 Divaricatori addominali



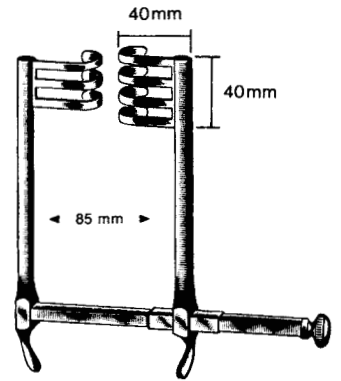
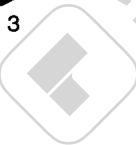
O'SULLIVAN - O'CONNOR
 19754-00
 compl.



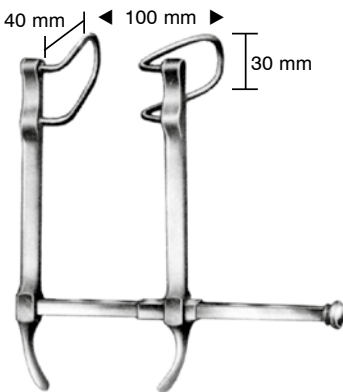
1



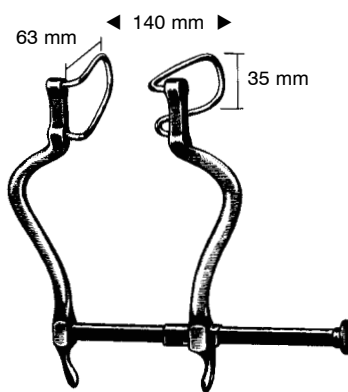
2



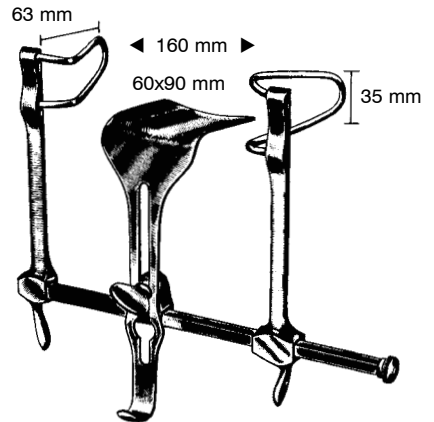
FRAZIER
 19758-85



BABY GOSSET
 19759-00

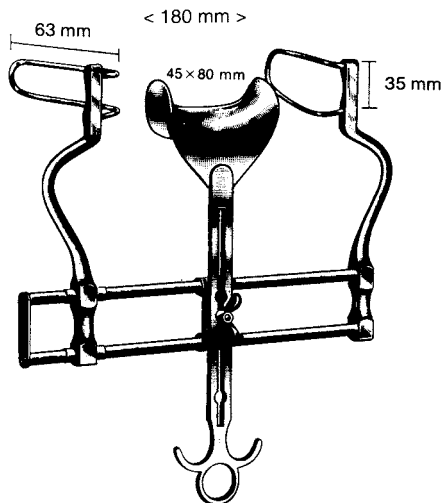


GOSSET
 19760-14

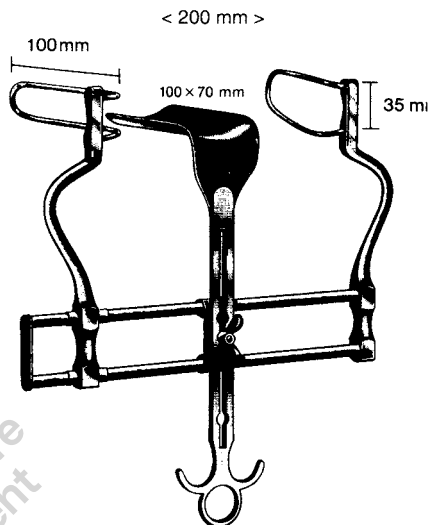


GOSSET
 19762-16

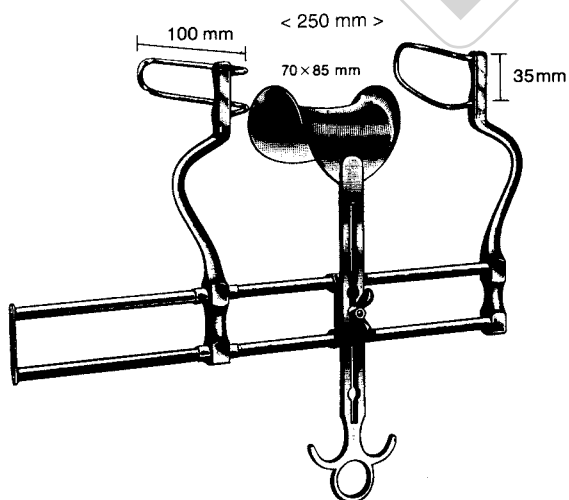
Bauchdeckenhalter
Abdominal Retractors
Separadores abdominales
Divaricatori addominali



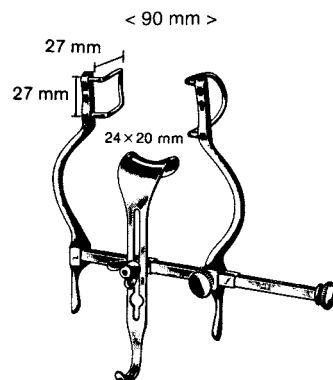
BALFOUR
19764-18
18 cm, 7"



BALFOUR
19764-20
20 cm, 8"

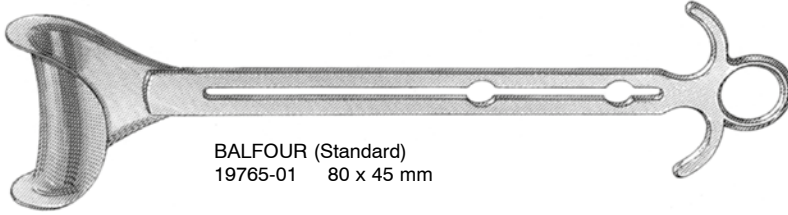


BALFOUR
19764-25
25 cm, 10"

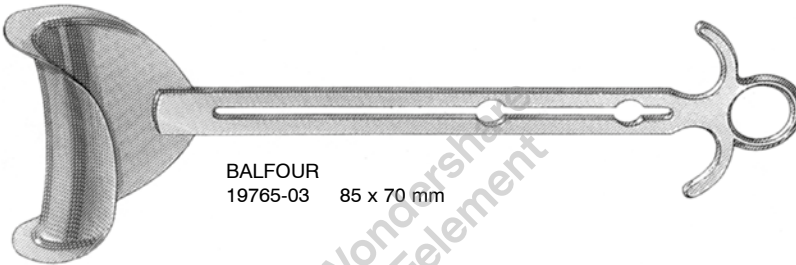


BALFOUR Baby
19766-90
9 cm, 3 1/2"

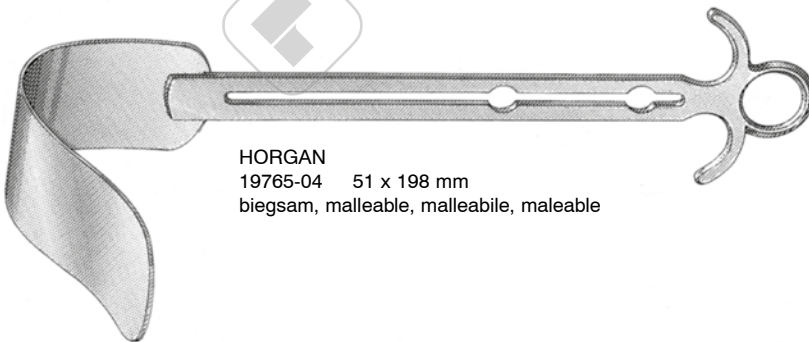
Bauchdeckenhalter
Abdominal Retractors
Separadores abdominales
Divaricatori addominali



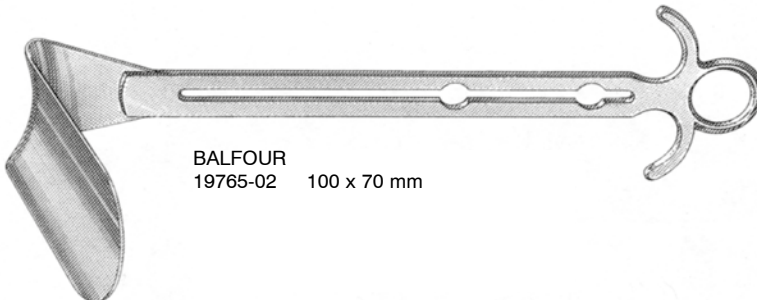
BALFOUR (Standard)
19765-01 80 x 45 mm



BALFOUR
19765-03 85 x 70 mm



HORGAN
19765-04 51 x 198 mm
biegsam, malleable, malleabile, maleable



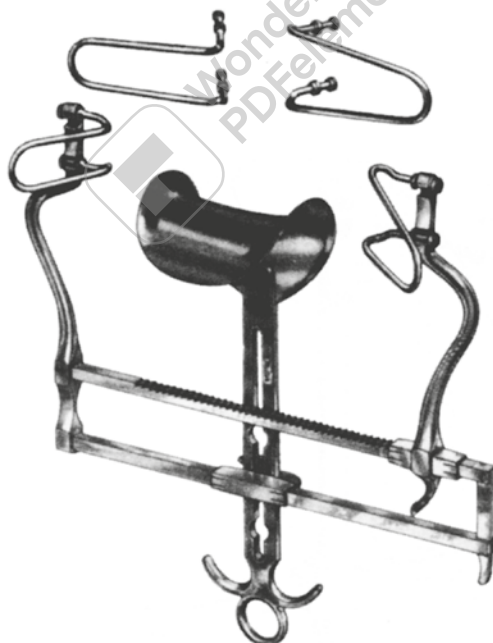
BALFOUR
19765-02 100 x 70 mm

Bauchdeckenhalter
Abdominal Retractors
Separadores abdominales
Divaricatori addominali



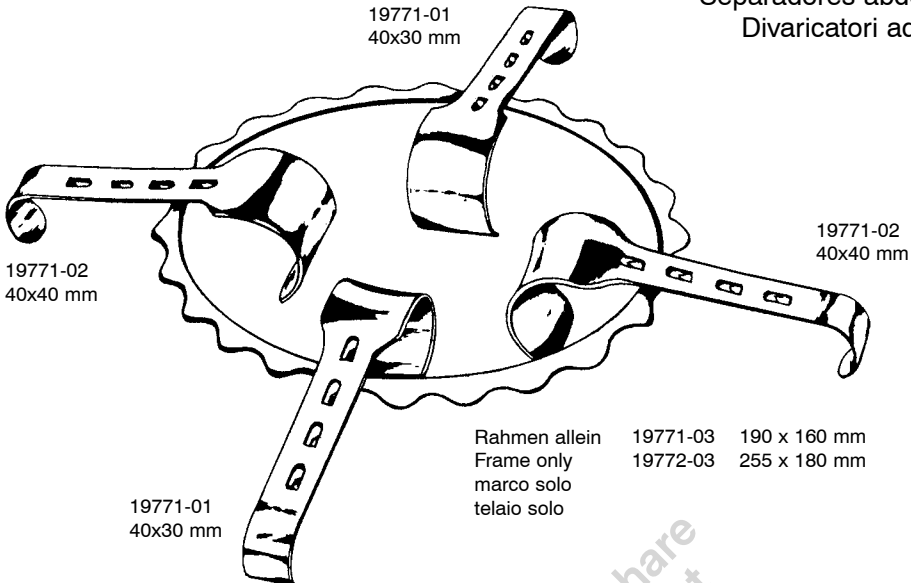
19767-01
Drahtvalven 5 cm (1.96") tief (Paar)
Fenestrated blades 5 cm (1.96") deep (pair)
Valvas de alambre 5 cm (1.96") profundidad (par)
Valve di filo profondità 5 cm (1.96") (paio)

19767-02
Drahtvalven 7,5 cm (2,95") tief (Paar)
Fenestrated blades 7,5 cm (2,95") deep (pair)
Valvas de alambre 7,5 cm 2,95") profundidad (par)
Valve di filo profondità 7,5 cm (2,95") (paio)



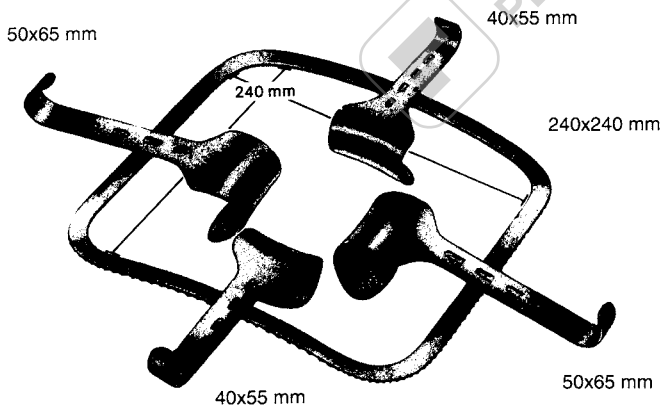
BALFOUR-US
19767-18
19767-25
komplett
complete
completo

Bauchdeckenhalter
Abdominal Retractors
Separadores abdominales
Divaricatori addominali

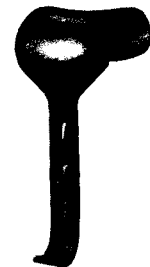


DENIS-BROWNE

19771-00 compl. Pediatric/pediatrico 190 x 160 mm
19772-00 compl. Adult/adulto 255 x 180 mm



KIRSCHNER



19781-55
40 x 55 mm breit

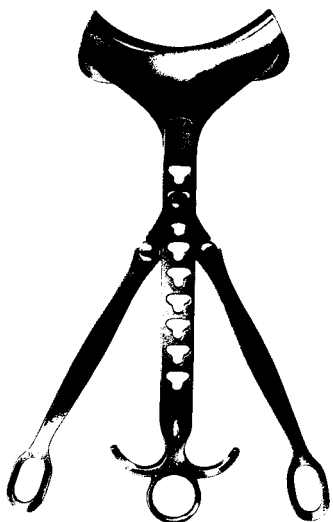


19781-65
50 x 65 mm breit

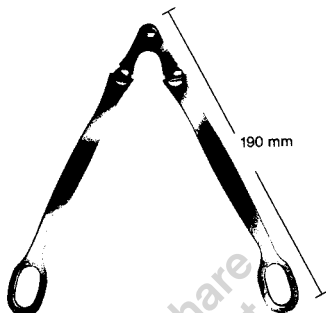
19782-00 Kirschner Bauchdeckenhalter komplett bestehend aus:
Kirschner Abdominal Retr. complete consisting of:
Kirschner separador abdominal completo compuesto de:
Kirschner Divaricatore addominale completo, composto da:

19781-55 2 Rahmenhaken / 2 Hook-on Retr. / 2 separadores / 2 divaricatori 40 x 55 mm
19781-65 2 Rahmenhaken / 2 Hook-on Retr. / 2 separadores / 2 divaricatori 50 x 65 mm
19783-24 Rahmen fest / frame rigid / marco rigido / telaio rigido 240 x 240 mm

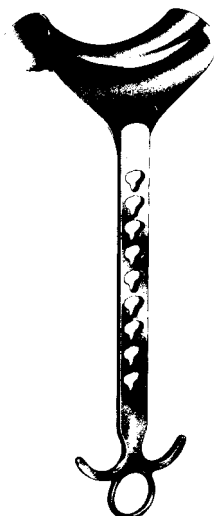
Bauchdeckenhalter
 Abdominal Retractors
 Separadores abdominales
 Divaricatori addominali



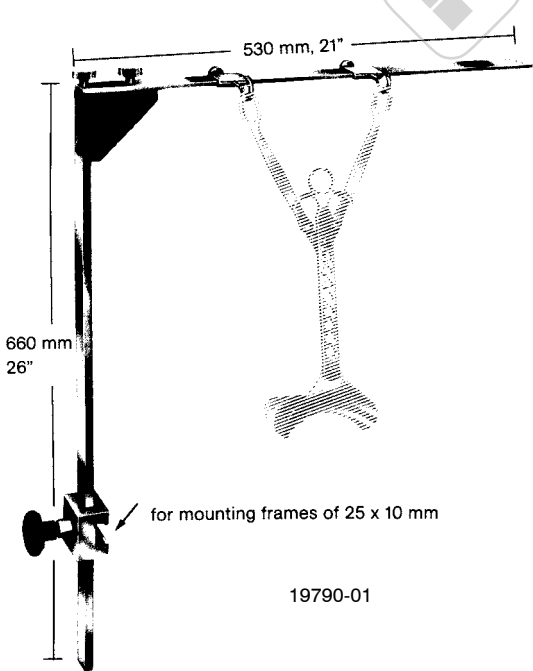
19780-01 + 19770-01



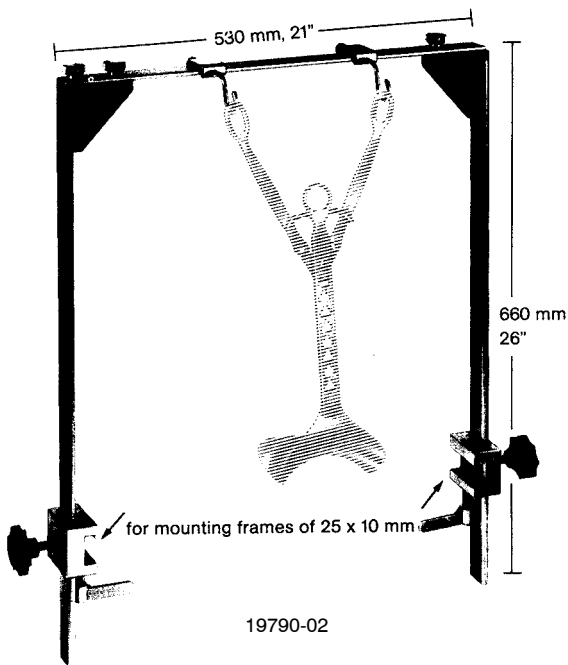
ROCHARD
 19780-01



ROCHARD
 31 cm, 12 1/4"
 19770-01 48x 90 mm
 19770-02 48x105 mm
 19770-03 48x120 mm
 19770-04 48x135 mm
 19770-05 48x155 mm

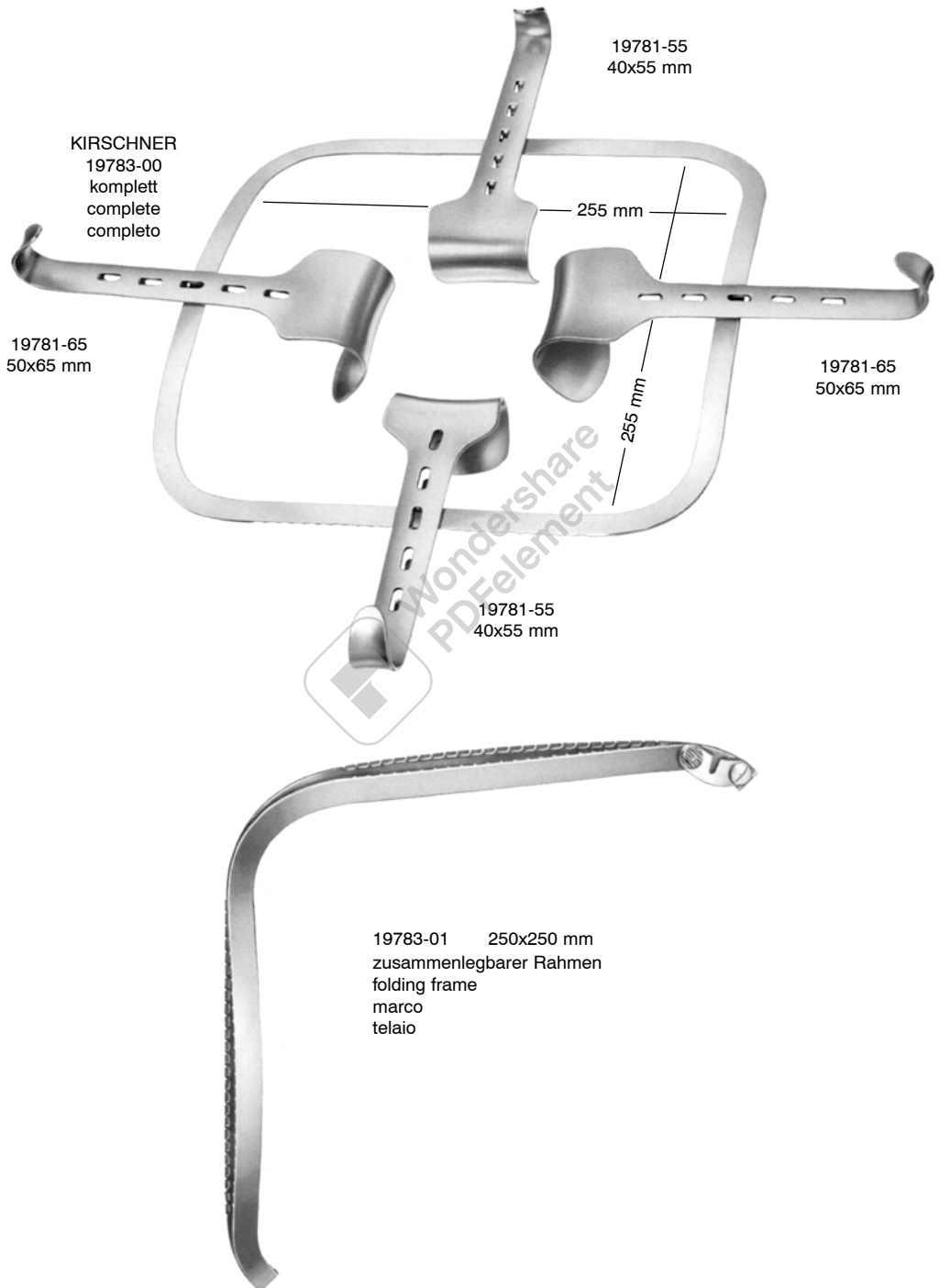


19790-01

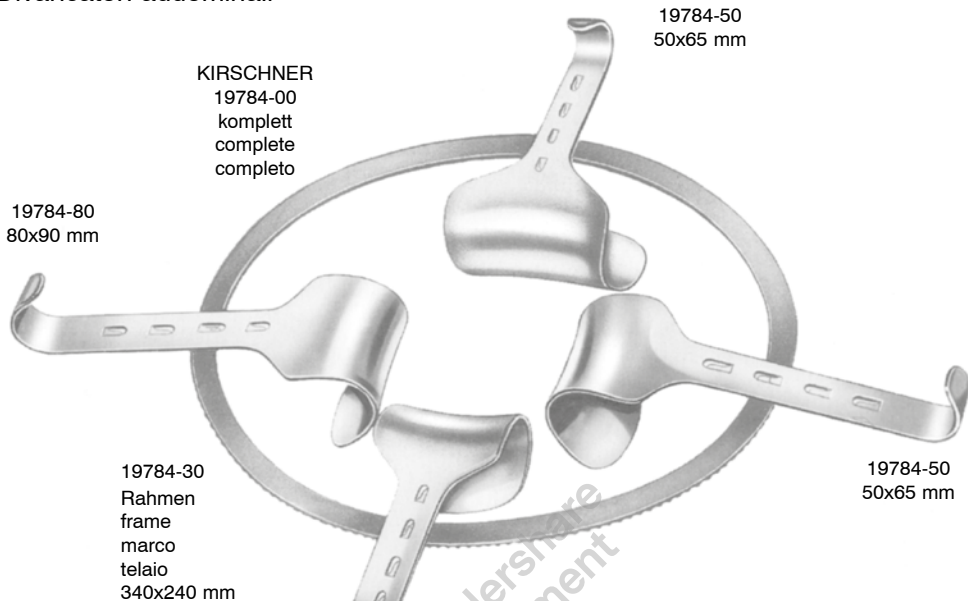


19790-02

Bauchdeckenhalter
Abdominal Retractors
Separadores abdominales
Divaricatori addominali

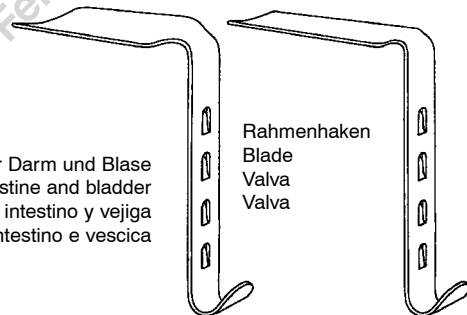


Bauchdeckenhalter
 Abdominal Retractors
 Separadores abdominales
 Divaricatori addominali



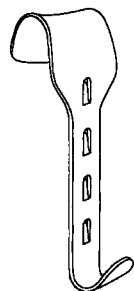
für Darm und Blase
 for intestine and bladder
 para intestino y vejiga
 per intestino e vescica

Rahmenhaken
 Blade
 Valva
 Valva

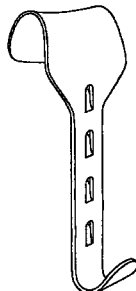


19784-98
 98x50 mm

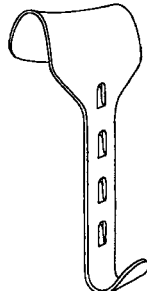
19784-99
 105x35 mm



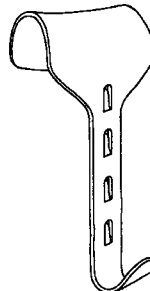
19784-40
 40x55 mm



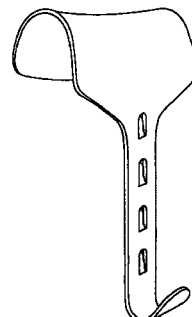
19784-50
 50x65 mm



19784-60
 60x85 mm



19784-78
 78x65 mm



19784-80
 80x90 mm



Arm System
Arm System
Sistema de brazo
Sistema braccio



19795-01

Armsystem Radius 310/420 mm komplett mit Wundhakenhalter und U-Stativ Ø 16 mm, 400 mm hoch, 400 mm breit, 170 mm tief (ohne Klemmsockel).

Arm System, radius 310/420 mm, including retractor and U-stand Ø 16 mm, 400 mm high, 400 mm wide, 170 mm deep (without clamp socket).



19795-02

Armsystem Radius 310/420 mm komplett mit Stativ, Klemmsockel und Endoskophalter Ø 8/10 mm.

Arm System, radius 310/420 mm, including stand, clamp, endoscope holder Ø 8/10 mm.



19798-01

Zweischlauchhalterung aus Aluminium
Double tube holder made of aluminium



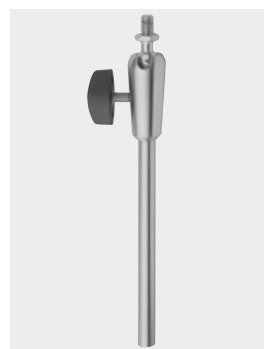
19798-02

Endoskophalterung Universal
Endoscope holder Universal
Ø 3-10 mm



19798-03

Universelle
Wundhakenhalterung
Universal retractor holder



19798-04

Gelenkverlängerung
180 mm lang mit Feststellung
Extended articulation
180 mm long, lockable

Arm System
Arm System
Sistema de brazo
Sistema braccio



19799-03
Leichtmetall-Klemmsocket Spannweite 35 mm, für ein Schraubstativ mit \varnothing 16 mm/M10, für Schienen 25/35 x 8/10 und Rohre \varnothing 12 - 35 mm. Clamp socket made of light metal, holding width 35 mm, for screw stand \varnothing 16 mm/M10, for rails 25/35 x 8/10 and tubes \varnothing 12 - 35 mm.



19799-04
Leichtmetall-Klemmsocket Spannweite 50 mm, für ein höhenverstellbares Stativ \varnothing 16 mm, für Schienen 25/35 x 8/10 und Rohre \varnothing 12 - 35 mm. Clamp socket made of light metal, holding width 50 mm, for height-adjustable stand \varnothing 16 mm, for rails 25/35 x 8/10 and tubes \varnothing 12 - 35 mm.



19799-05
Klemmsocket aus rostfreiem Stahl, für ein höhenverstellbares Stativ \varnothing 16 mm, elektrisch isoliert bis 4,5 kV AC, Spannweite 50 mm für Schienen 25/32 x 8/12 mm. Clamp socket made of stainless steel, for height-adjustable stand \varnothing 16 mm, electrically insulated up to 4.5 kV AC, holding width of 50 mm for rails 25/32 x 8/12 mm.



19799-06
Leichtmetall-Klemmsocket Spannweite 50 mm, für ein Schraubstativ mit \varnothing 16 mm/M10, für Schienen 25/35 x 8/10 und Rohre \varnothing 12 - 35 mm. Clamp socket made of light metal, holding width 50 mm, for screw stand \varnothing 16 mm/M10, for rails 25/35 x 8/10 and tubes \varnothing 12 - 35 mm.

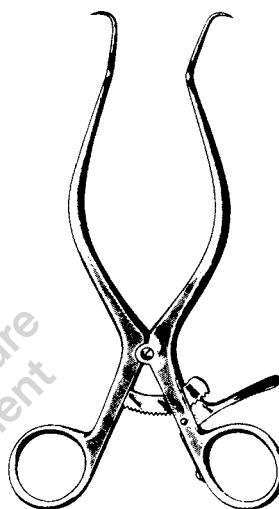
Bauchdeckenhalter, Wundsperrer
Abdominal Retractors, Retractors
Separadores abdominales, Separadores
Divaricatori addominali, Divaricatori



DOYEN

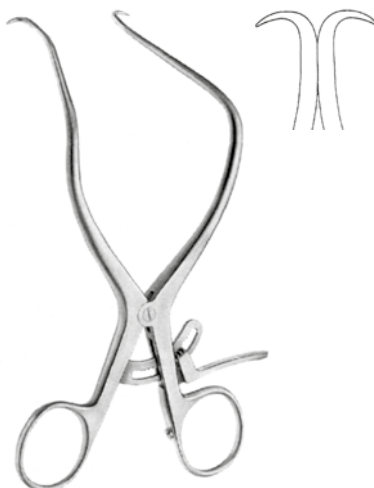
28 cm, 11"

19800-01 48x 90 mm
19800-02 48x105 mm
19800-03 48x120 mm
19800-04 48x135 mm



GELPI

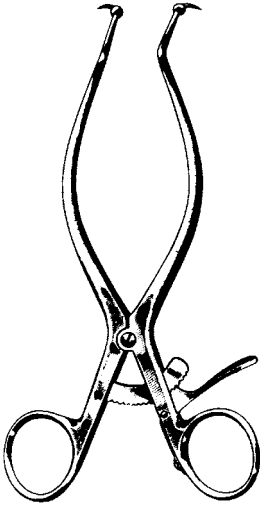
19802-09 9 cm, 3 1/2"
19802-11 11 cm, 4 3/8"
19802-14 14 cm, 5 1/2"
19802-16 16 cm, 6 1/4"
19802-18 18 cm, 7"



DE BAKEY

19803-14
14,5 cm, 5 3/4"

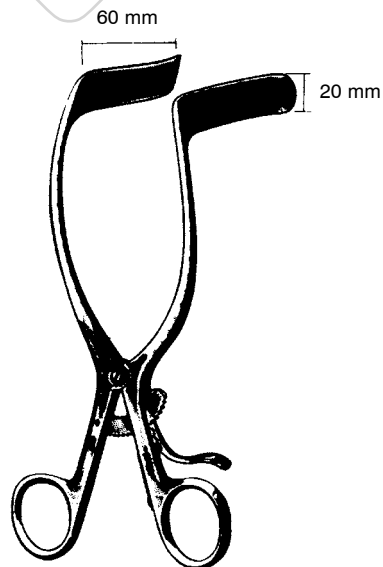
Wundsperrer
Retractors
Separadores
Divaricatori



GELPI
19804-18
18 cm, 7"



JACKSON BURROWS
19805-18
18,5 cm, 7 1/4"

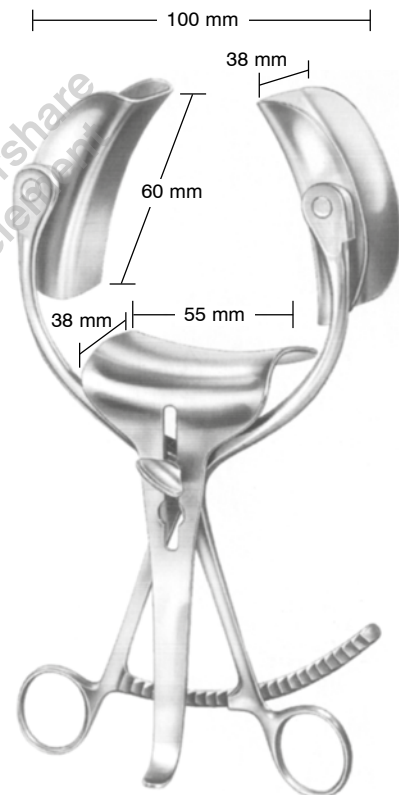


RIGBY
19806-18
18 cm, 7"

Bauchdeckenhalter
Abdominal Retractors
Separadores abdominales
Divaricatori addominali

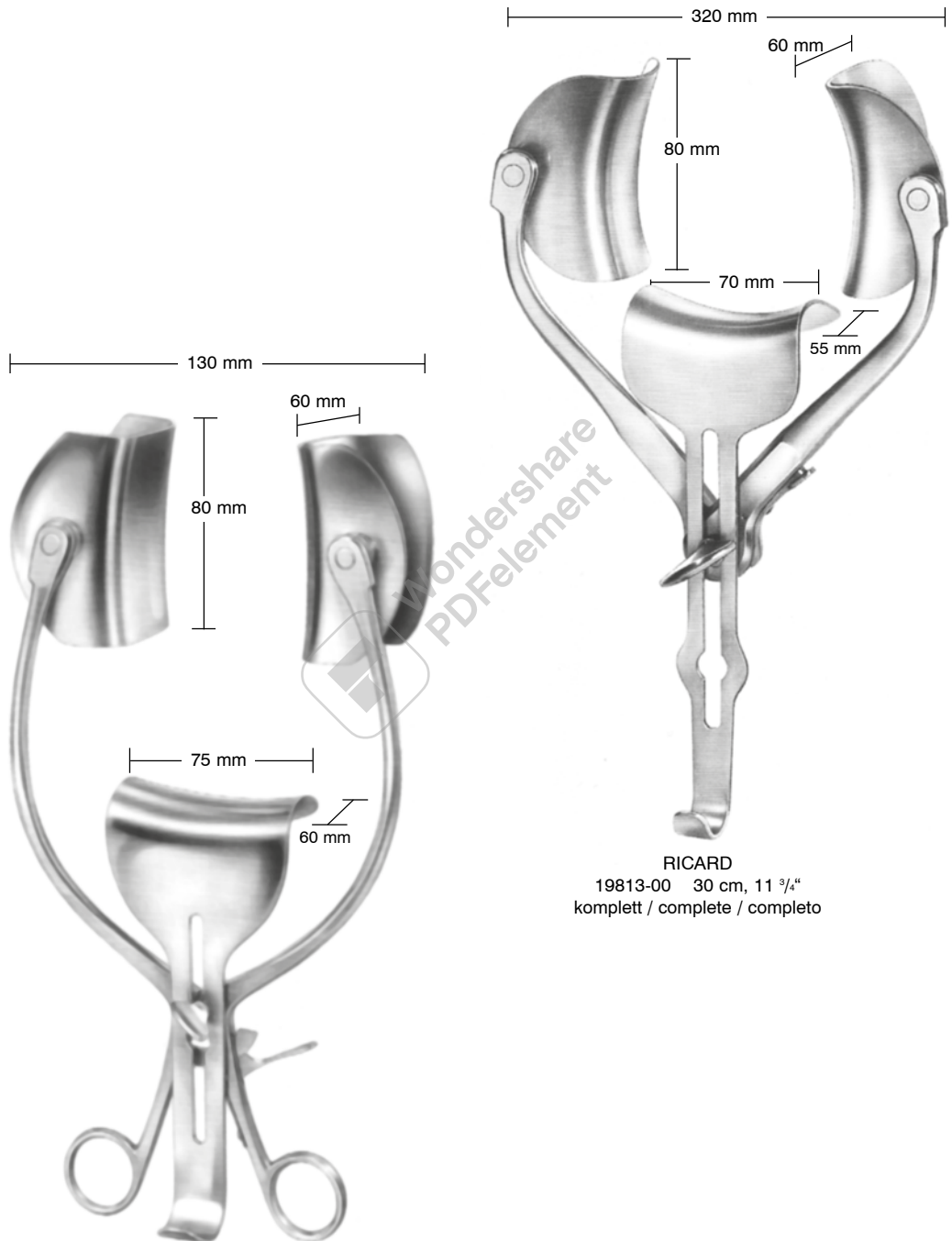


COLLIN
19810-22
komplett
complete
completo



COLLIN
19812-60
komplett
complete
completo

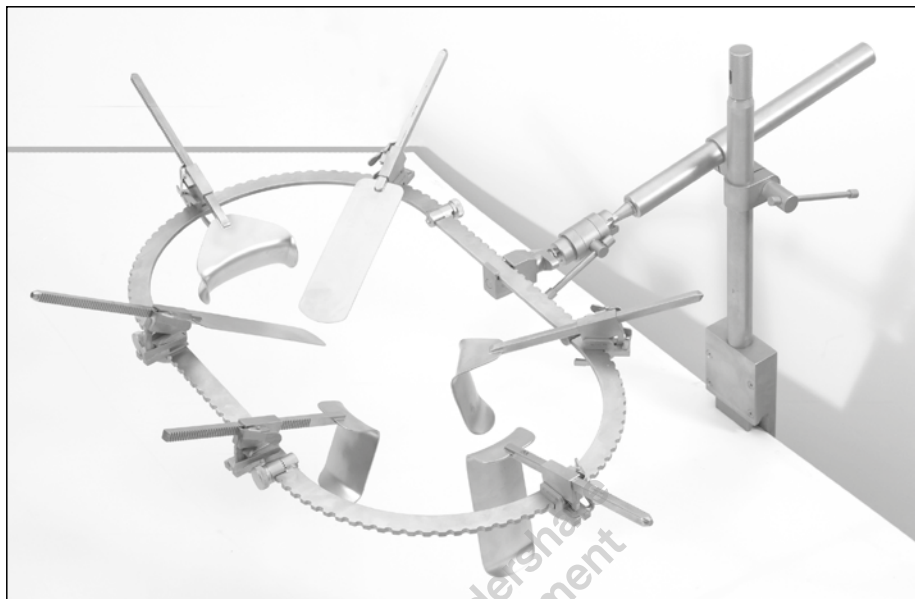
Bauchdeckenhalter
Abdominal Retractors
Separadores abdominales
Divaricatori addominali



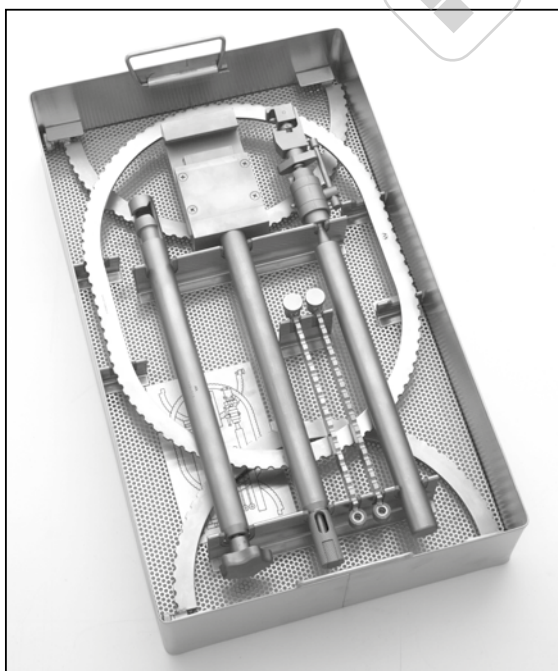
RICARD
19813-00 30 cm, 11 ³/₄"
komplett / complete / completo

COLLIN Loktite
19816-00 31 cm, 12 ¹/₄"
komplett / complete / completo

Back holder Abdominal Retractor Operation Table Set



Complete Fixed Abdominal Retractor Set
Set completo divaricatore addominale con sistema di montaggio modulare



The many components of the **Back holder Abdominal Retractor Operation Table Set**

can all be neatly arranged into autoclave sized containers with diagrams that direct instrument handlers on proper placement of each component.

*A major convenience in care and maintenance
of the Retractor Set*

Sterilization Container & Baskets

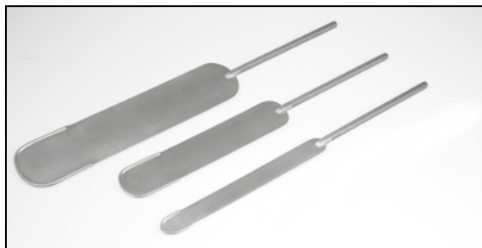
Description	Product No
Table Fixation & Ring Case	19820-90
Blade & Accessories Case	19820-91

Back holder Abdominal Retractor Operation Table Set

Description	Product No	Composto da	
Complete Abdominal Retractor Set	19820-99	Accoppiatore	19821-01
		Barra orizzontale	19821-02
<i>Includes</i>		Morsetto di accoppiamento	19821-04
Table Post	19821-01	Anello ovale	19820-02
Horizontal Bar	19821-02	No. 2 retrattori malleabili, 51x152 mm	19825-06
1" Post Coupling	19821-04	No. 2 Valve Kelly, dim. 51x76 mm	19822-23
Oval Ring	19820-02	Valva Kelly	19822-24
2" X 6" Malleable Retractor (2 ea)	19825-06	Valva Balfour	19823-33
2" X 3" Kelly Retractor (2 ea)	19822-23	Morsetto trasportabile con trasporto ad intervallo progressivo di 2 mm	19820-10
2" X 4" Kelly Retractor	19822-24	Morsetto articolato multidisciplinare con funzione movimento assiale orizzontale e verticale	19820-20
Balfour Retractor	19833-33	Anello ovale 266x367 mm	19820-02
Ratchet Mechanism (2 ea)	19820-10	Anello a segmento 266x495 mm	19820-03
Tilt Ratchet Mechanism (6 ea)	19820-20	Retrattore malleabile 38x152 mm	19824-06
Segmented Ring	19820-03	Retrattore malleabile 76x152 mm	19826-06
1 1/2" X 6" Malleable Retractor	19824-06	Valva Kelly, 51x127 mm	19822-25
3" x 6" Malleable Retractor	19826-06	Valva Kelly, 51x152 mm	19822-26
2" X 5" Kelly Retractor	19822-25	Barra flessibile orizzontale	19821-03
2" X 6" Kelly Retractor	19822-26	Retrattore Harrington 63x143 mm	19831-25
Horizontal Flex Bar	19821-03	Retrattore con punta Gelpi	19834-01
Harrington Retractor	19831-25		
Gelpi Retractor	19834-01		
<i>Accessories</i>		<i>Accessori:</i>	
Table Fixation & Ring Case	19820-90	Container vuoto in acciaio inox dotato con griglia interna	
Blades & Accessories Case	19820-91	Descrizione	
		Container in acciaio inox dotato di griglia interna per Accessori di fissazione, anelli e barre	19820-90
		Container in acciaio inox dotato di griglia interna per morsetti e divaricatori	19820-91



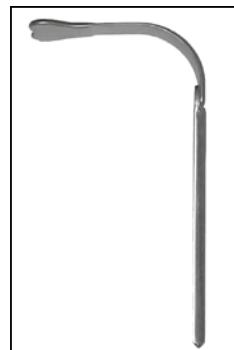
Malleable Retractors with Protective Edge



Description	Product No
1 1/2" x 6" 38 x 152 mm	19824-06
2" x 6" 51 x 152 mm	19825-06
3" x 6" 76 x 152 mm	19826-06

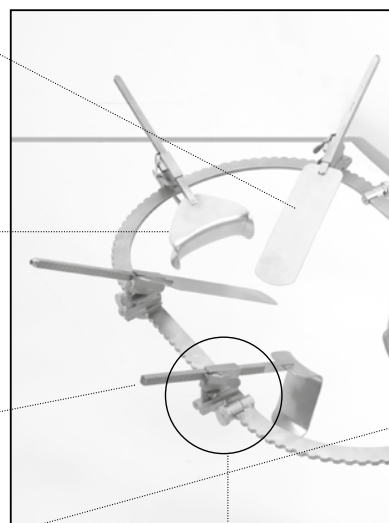
Specialty Retractors

Description	Product No
Balfour Retractor 2 5/8" x 3" 67 x 76 mm	19833-33
Gelpi Point Retractor	19834-01



Harrington Retractors

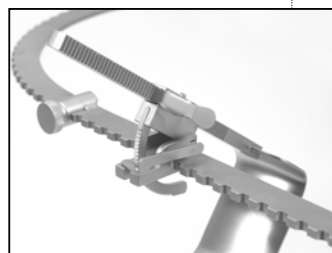
Description	Product No
Blade 2.5" x 5 5/8" 63 x 143 mm	19831-25



Description	Product No
Blade 2" x 1 1/2"	51 x 38 mm 19822-21
Blade 2" x 2"	51 x 51 mm 19822-22
Blade 2" x 2 1/2"	51 x 64 mm 19822-22L
Blade 2" x 3"	51 x 76 mm 19822-23
Blade 2" x 4"	51 x 102 mm 19822-24
Blade 2" x 5"	51 x 127 mm 19822-25
Blade 2" x 6"	51 x 152 mm 19822-26



Description	Product No
Blade 1" x 1 1/2" 25 x 38 mm	19822-01
Blade 1" x 2 1/2" 25 x 63 mm	19822-02



Tilt Ratchet Mechanism allows extensions or retractions along the horizontal axis and allows vertical movement of retractor blade with a second ratchet

Product No 19820-20

Table Mounting Components

Description	Product No
1" Post Coupler	19821-04

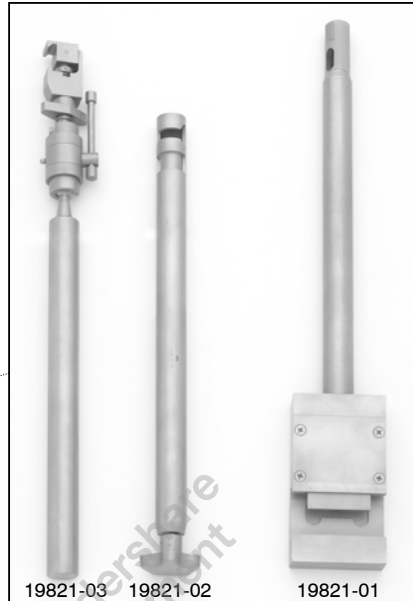
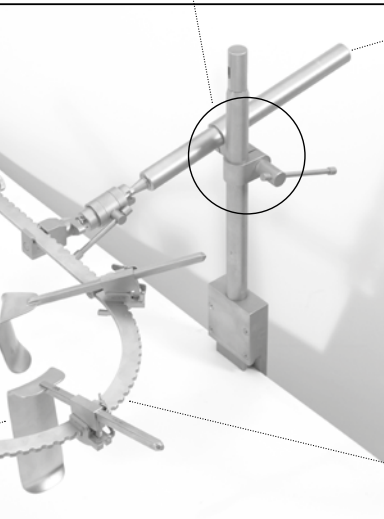
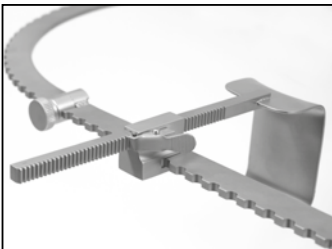


Table Mounting Components

Table Post	19821-01
Horizontal Bar	19821-02
Horizontal Flex Bar	19821-03



Fixed Ratchet Mechanism allows extension or retraction along the horizontal axis at 2mm intervals

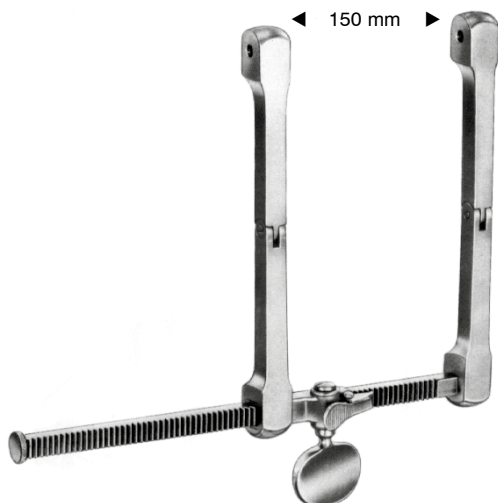
Product No 19820-10



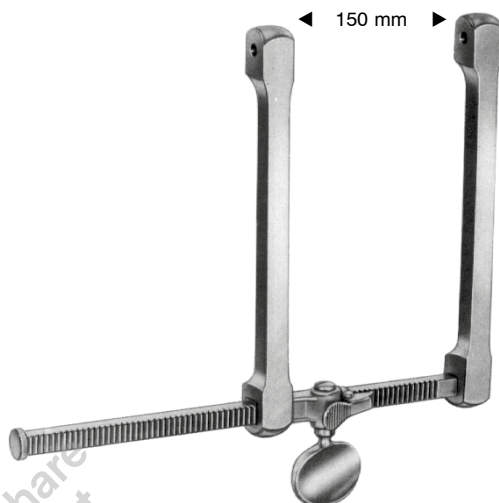
Retractor Rings

Description	Product No
Oval Ring 10.5 x 14.5 inch / 266 x 367 mm	19820-02
Segmented Ring 10.5 x 19.5 inch / 266 x 495 mm (Consists of one 10.5 inch Round Ring and two 8 inch straight segments)	19820-03

Laminektomiespreizer
Laminectomy Retractors
Separadores para laminectomia
Divaricatori per laminectomia



SCOVILLE-HAVERFIELD
19910-00
Rahmen allein
Frame only
Marco solo
Telaio solo



SCOVILLE
19911-00
Rahmen allein
Frame only
Marco solo
Telaio solo



SCOVILLE
50 mm, 2"
19912-50



SCOVILLE
70 mm, 2 3/4"
19912-70



SCOVILLE
19914-41 41 x 38 mm
19914-67 67 x 44 mm



TAYLOR
19915-48 48 x 50 mm
19915-64 64 x 50 mm
19916-64 64 x 64 mm
19916-80 80 x 57 mm



SCOVILLE
50 mm, 2"
19913-50



SCOVILLE
70 mm, 2 3/4"
19913-70



SCOVILLE
19917-64 64 x 25 mm
19918-64 64 x 50 mm
19918-88 88 x 25 mm

Wundhaken für plastische Chirurgie
 Retractors for plastic surgery
 Separadores para cirugía plástica
 Divaricatore per chirurgia plastica



mit Kaltlicht + Absaugung
 with cold light + aspiration
 con luz fria + aspiracion
 con luce fredda + aspirazione

TEBBETTS

19980-01	80 mm x 16 mm
19980-02	100 mm x 25 mm
19980-03	120 mm x 25 mm
19980-04	120 mm x 30 mm
19980-05	150 mm x 25 mm
19980-06	150 mm x 30 mm



FERRIERA

19960-01	80 mm x 16 mm
19960-02	100 mm x 25 mm
19960-03	120 mm x 25 mm
19960-04	120 mm x 30 mm
19960-05	150 mm x 25 mm
19960-06	150 mm x 30 mm

Wundhaken für plastische Chirurgie
Retractors for plastic surgery
Separadores para cirugía plástica
Divaricatore per chirurgia plastica



22 x 54 mm

37 x 70 mm

BREAST
19970-01
31 cm, 12 1/4"



70 mm

CORONAL
19980-18
18 cm, 7"



150 mm

YANCOSKIE
19990-18
18 cm, 7"



FREEMAN
19995-38 18 cm, 7"
38 mm, 1 1/2" wide
19995-22 18 cm, 7"
22 mm, 7/8" wide



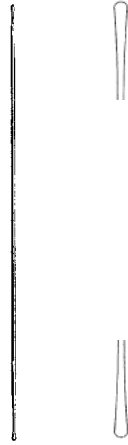
ANDERSON
19998-03 12 cm, 4 3/4" 3 Zähne
3 prongs
3 dientes
3 uncini
19998-05 12 cm, 4 3/4" 5 Zähne
5 prongs
5 dientes
5 uncini

Sonden
Probes, Directors
Sondas, estiletes
Sonde, specilli



2 mm \varnothing

11,5 cm, 4 1/2" 21102-11
13,0 cm, 5 1/8" 21102-13
14,5 cm, 5 3/4" 21102-14
16,0 cm, 6 1/4" 21102-16
18,0 cm, 7" 21102-18
20,0 cm, 8" 21102-20
25,0 cm, 10" 21102-25



1 mm \varnothing

21104-11
21104-13
21104-14
21104-16
21104-18
21104-20
21104-25



2 mm \varnothing

21106-11
21106-13
21106-14
21106-16
21106-18
21106-20
21106-25



21108-14
14,5 cm, 5 3/4"



BRODIE
21109-18
18 cm
7"



13,0 cm, 5 1/8" 21110-13
14,5 cm, 5 3/4" 21110-14
16,0 cm, 6 1/4" 21110-16
18,0 cm, 7" 21110-18
20,0 cm, 8" 21110-20



DOYEN
21111-14
14 cm
5 1/2"



21112-14
14,5 cm
5 3/4"



STACKE
21115-10
10,5 cm
4.1"



NELATON
21120-16
16 cm
6 1/4"



FISH
21121-14
14 cm, 5 1/2"
21121-18
18 cm, 7"

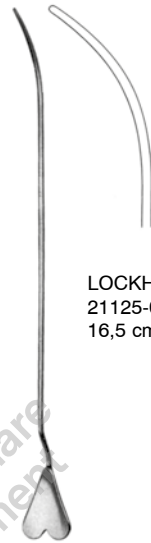


WATSON-CHEYNE
21122-13
13 cm, 5 1/8"
21122-18
18 cm, 7"

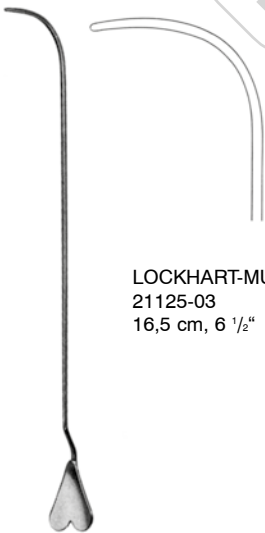
Fistelsonden
Fistula Probes
Sondas para fistula
Sonde per fistole



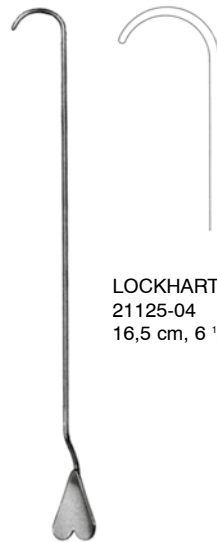
LOCKHART-MUMMERY
21125-01
16,5 cm, 6 1/2"



LOCKHART-MUMMERY
21125-02
16,5 cm, 6 1/2"

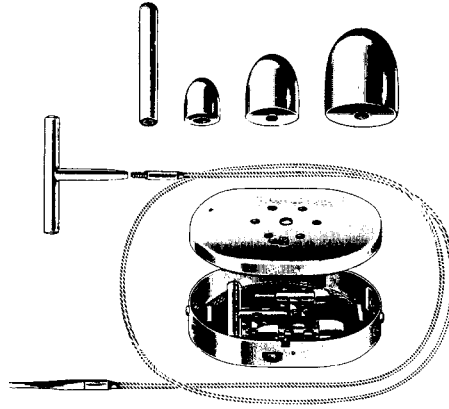


LOCKHART-MUMMERY
21125-03
16,5 cm, 6 1/2"

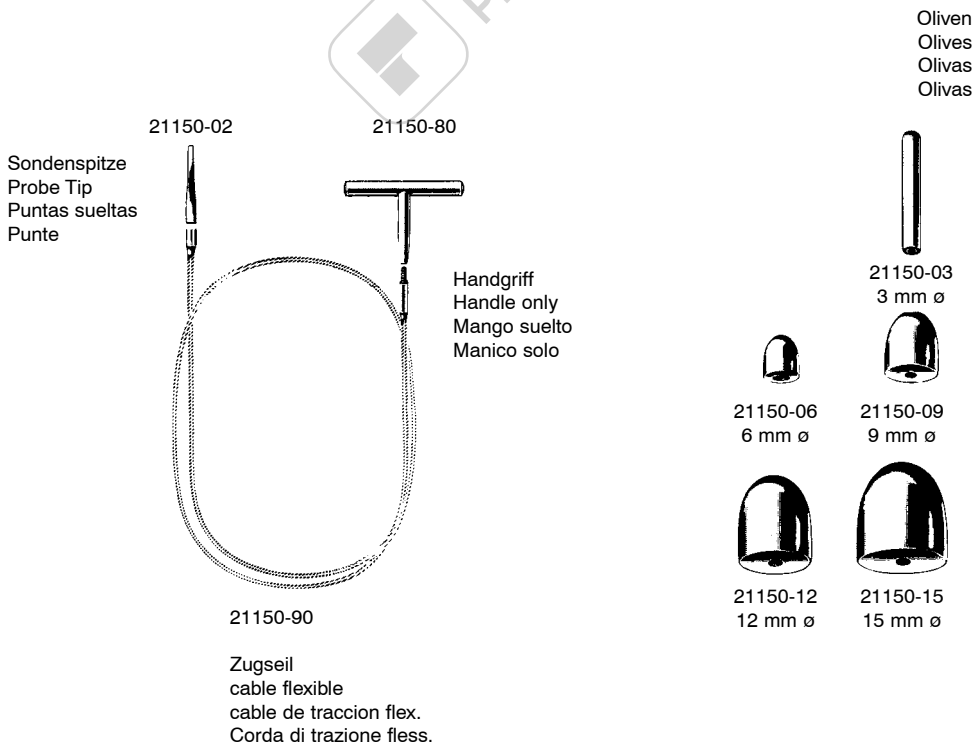


LOCKHART-MUMMERY
21125-04
16,5 cm, 6 1/2"

Krampfader-Besteck in Metalletui
 Varicose vein probe set in metal case
 Juego para várices en estuche de metal
 Astuccio per varici in scatola di metallo



NABATOFF
 21150-00
 135x100x25 mm
 compl.



Varizeninstrumente
Varix Instruments
Instrumentos para varices
Strumenti per varici



VARADY
21154-01
180 mm, 7"



VARADY
21154-02
180 mm, 7"



VARADY
21154-03
180 mm, 7"



VARADY
21154-04
175 mm, 6.9"

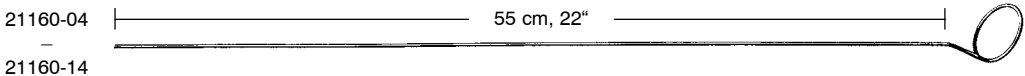


VARADY
21154-05
170 mm, 6 3/4"



VARADY
21154-06
170 mm, 6 3/4"

21162-12
12 cm, 4 3/4"
Griff
Handle
Mango
Manico



21160-04
4 mm ø



21160-06
6 mm ø



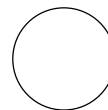
21160-07
7 mm ø



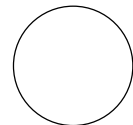
21160-08
8 mm ø



21160-10
10 mm ø



21160-12
12 mm ø



21160-14
14 mm ø

Watteträger, Spatel
Cotton Applicators, Spatulas
Porta-algodones, Espátulas
Portacotone, Spatole



FARRELL

4 3/4"	21270-12	12,0 cm
5 1/2"	21270-14	14,0 cm
6 1/2"	21270-16	16,5 cm
7"	21270-18	18,0 cm
9"	21270-23	23,0 cm



FARRELL

4 3/4"	21272-12	12,0 cm
5 1/2"	21272-14	14,0 cm
6 1/2"	21272-16	16,5 cm
7"	21272-18	18,0 cm
9"	21272-23	23,0 cm



HADEO

4 3/4"	21290-12	12,0 cm
5 1/2"	21290-14	14,0 cm
6 1/2"	21290-16	16,0 cm
7"	21290-18	18,0 cm

1,5



1,5

HADEO

4 3/4"	21292-12	12,0 cm
5 1/2"	21292-14	14,0 cm
6 1/2"	21292-16	16,0 cm
7"	21292-18	18,0 cm



ø 3 mm

Spatel
Plaster spatula
Espátula
Spatole



21190-14
14,5 cm, 5 3/4"



UCKERMANN
21310-15
15 cm, 6"



JOBSON-HORNE
21320-12 12 cm, 4 3/4"
21320-18 18 cm, 7"

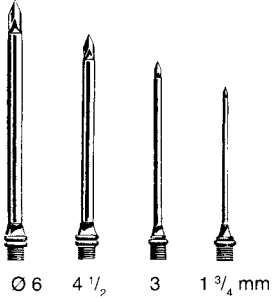


TOBOLD
21331-25
25 cm, 10"



21340-45
45 cm, 17 3/4"

Trokare
Trocars
Trócares
Trequarti



Ø 6 4 1/2 3 1 3/4 mm



UNIVERSAL
23104-00
compl.



STANDARD (NELSON)

- 23110-30 3,0 mm ø
- 23110-35 3,5 mm ø
- 23110-40 4,0 mm ø
- 23110-45 4,5 mm ø
- 23110-50 5,0 mm ø
- 23110-55 5,5 mm ø
- 23110-60 6,0 mm ø

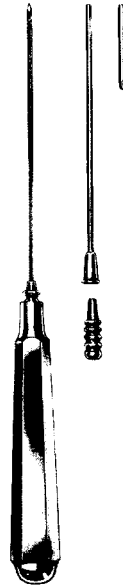


PIERCE

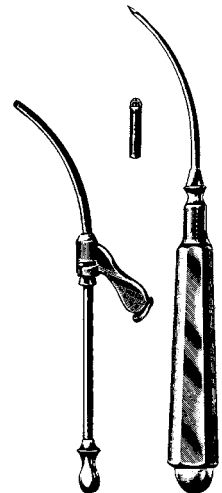
- 23123-30 3,0 mm Ø
- 23123-40 4,0 mm Ø
- 23123-50 5,0 mm Ø



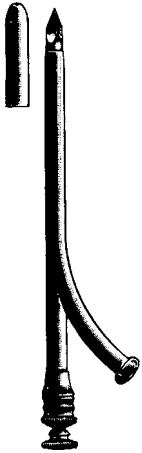
DOUGLAS
23125-11 3 mm Ø



LICHTWITZ
23128-19 1,75 mm Ø



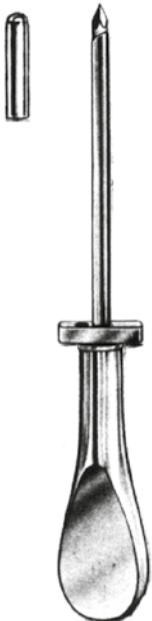
COAKLEY
23140-02 2,25 mm Ø

Trokare
Trocars
Trócares
Trequarti

Charr./	F.G.	OCHSNER
10	23150-10	
12	23150-12	
14	23150-14	
16	23150-16	
18	23150-18	
20	23150-20	



Charr./	F.G.	NELSON	ø
25	23170-25		7,5 mm
30	23170-30		9,0 mm
33	23170-33		10,5 mm
35	23170-35		12,0 mm



SINOSKOPIE-TROKAR
8,5 cm, 3.4"

23181-40 f. Optik mit Ø 4,0 mm

Biopsiekanülen
Biopsy Needles
Agujas para biopsia
Aghi per biopsia

Nadelführer
Pudendus
Anesthésie
anestesia



IOWA
23210-00
14 cm, 5 1/2"
compl.

Pneumoperitoneum
Pneumoperitoneum
Neumoperitoneo
Pneumoperitoneo



VERRES
23250-20 2,00x100 mm
23250-40 2,00x140 mm

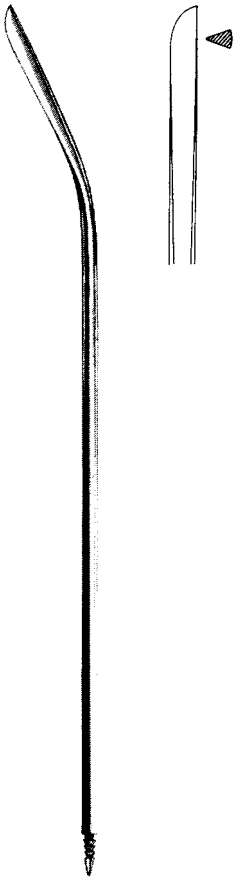


MENGHINI
23302-01 1,0x 35 mm
23302-02 1,0x 70 mm
23302-03 1,2x 70 mm
23302-04 1,2x100 mm
23302-05 1,4x 70 mm
23302-06 1,4x100 mm
23302-07 1,6x 70 mm
23302-08 1,8x100 mm



MENGHINI
23310-14 1,4x168 mm
23310-18 1,8x168 mm

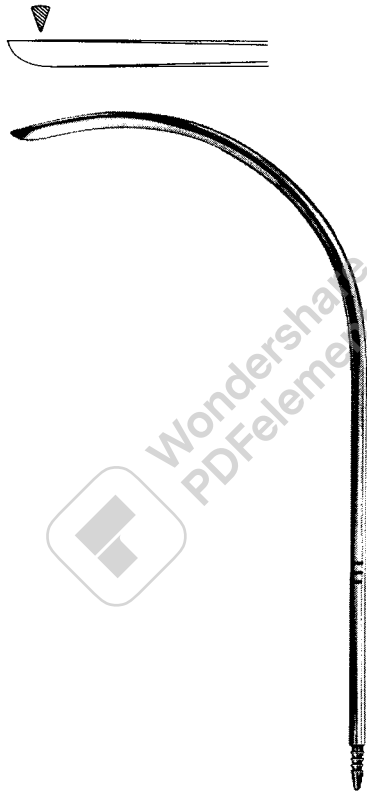
Führungsnadeln
Guide needles
Aguja de Guía
Ago guida



REDON
23195-08 - 23195-18

Messerspitze, gerade
Guide Needle, straight
Aguja de guía, recta
Ago guida, retta

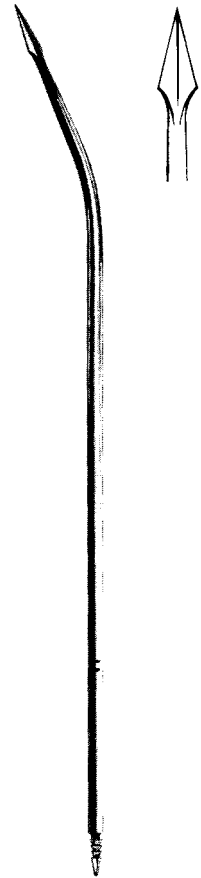
Charr./Fr.
8 23195-08
10 23195-10
12 23195-12
14 23195-14
16 23195-16
18 23195-18



REDON
23197-08 - 23197-18

Messerspitze, gebogen
Guide Needle, curved
Aguja de guía, curva
Ago guida, curva

Charr./Fr.
8 23197-08
10 23197-10
12 23197-12
14 23197-14
16 23197-16
18 23197-18



REDON
23198-08 - 23198-18

Lanzettspitze, gerade
Lancet tip, straight
Punta lanceolar, recta
Punta lanceolata, retta

Charr./Fr.
8 23198-08
10 23198-10
12 23198-12
14 23198-14
16 23198-16
18 23198-18

Nadelhalter
Needle Holders
Porta-agujas
Port'aghi



DERF

25110-12 12 cm, 4 3/4"
25114-12 TC 12 cm, 4 3/4"

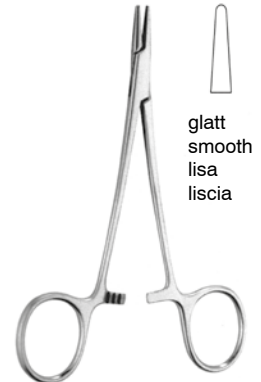


DERF

25120-12 12,5 cm, 5"

COLLIER

25122-12 12,5 cm, 5"



glatt
smooth
lisa
liscia

WEBSTER

25128-13 13 cm, 5 1/8"
25129-13 TC 13 cm, 5 1/8"

BABY-WEBSTER

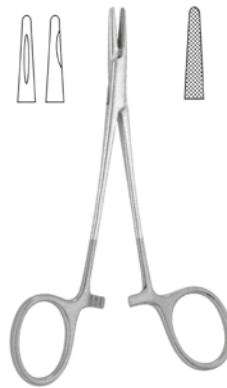
25136-11 11 cm, 4 3/8"
25137-11 TC 11 cm, 4 3/8"

25138-11 TC 11 cm, 4 3/8"
gerieft/serrated
estriada/zigrinato



HALSEY

25130-13 25140-13
25134-13 TC 25144-13 TC
13 cm, 5 1/8"



NEIVERT

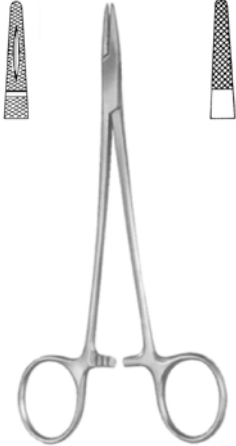
25146-13 25148-13 TC
13 cm, 5 1/8"



BAUMGARTNER

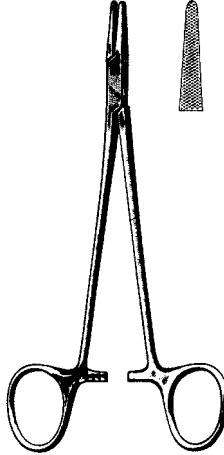
25150-12 25154-12 TC
12,5 cm, 5"
25150-14 25154-14 TC
14,0 cm, 5 1/2"

Nadelhalter
Needle Holders
Porta-agujas
Port'aghi



CRILE-WOOD

25160-15	15 cm, 6"	25164-15 TC
25160-18	18 cm, 7"	25164-18 TC
25160-20	20 cm, 8"	25164-20 TC
25160-23	23 cm, 9"	25164-23 TC



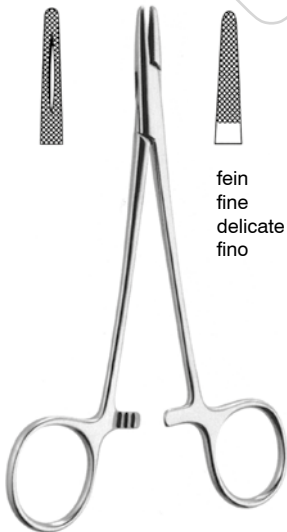
CRILE-MURRAY

25170-15	25174-15 TC
15 cm, 6"	



MAYO-HEGAR

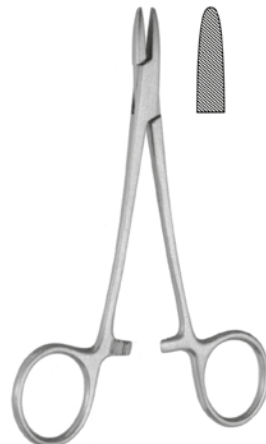
25180-12	12 cm, 4 3/4"	25184-12 TC
25180-14	14 cm, 5 1/2"	25184-14 TC
25180-16	16 cm, 6 1/4"	25184-16 TC
25180-18	18 cm, 7"	25184-18 TC
25180-20	20 cm, 8"	25184-20 TC
25180-24	24 cm, 9 1/2"	25184-24 TC
25180-26	26 cm, 10 1/4"	25184-26 TC
25180-30	30 cm, 11 3/4"	25184-30 TC



fein
fine
delicate
fino

MAYO-HEGAR

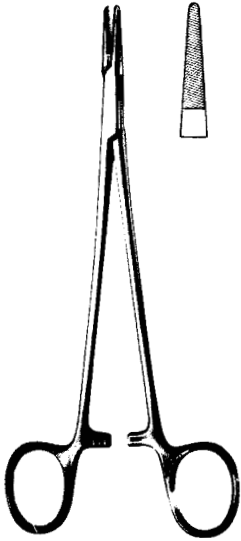
25190-16	16 cm, 6 1/4"	25194-16 TC
25190-18	18 cm, 7"	25194-18 TC
25190-20	20 cm, 8"	25194-20 TC



BROWN

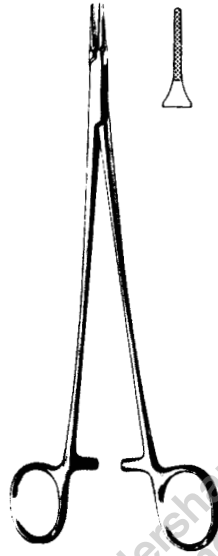
25196-13	13 cm, 5 1/8"
25196-18	18 cm, 7"

Nadelhalter
Needle Holders
Porta-agujas
Port'aghi



DE BAKEY

- 25214-16 TC 16 cm, 6 1/4"
- 25214-18 TC 18 cm, 7"
- 25214-20 TC 20 cm, 8"
- 25214-23 TC 23 cm, 9"
- 25214-26 TC 26 cm, 10 1/4"
- 25214-31 TC 31 cm, 12 1/4"

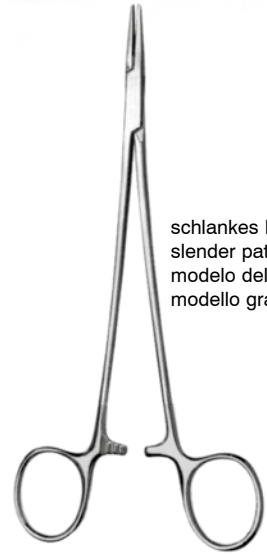


RYDER 1 mm

- 25224-13 TC 13 cm, 5 1/8"
- 25224-15 TC 15 cm, 6"
- 25224-18 TC 18 cm, 7"
- 25224-20 TC 20 cm, 8"
- 25224-23 TC 23 cm, 9"
- 25224-26 TC 26 cm, 10 1/4"

RYDER 2 mm

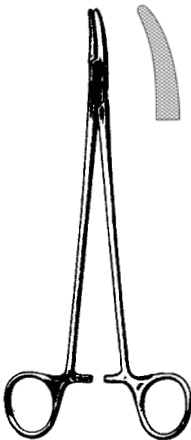
- 25225-13 TC
- 25225-15 TC
- 25225-18 TC
- 25225-20 TC
- 25225-23 TC
- 25225-26 TC



schlankes Modell
slender pattern
modelo delgado
modello gracile

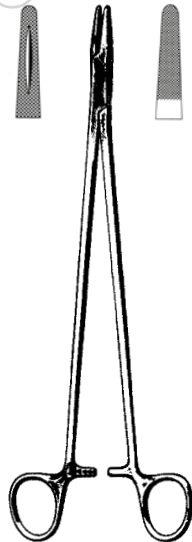
MICROVASCULAR

- 25230-18 TC 18 cm, 7"
- 25230-20 TC 20 cm, 8"
- 25230-23 TC 23 cm, 9"



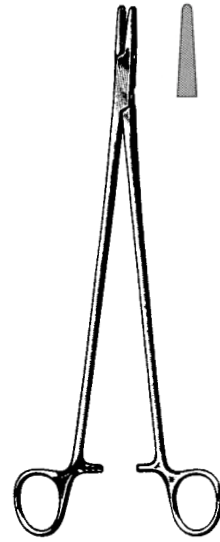
HEANEY

- 25241-21 21 cm, 8 1/4"
- 25241-26 26 cm, 10 1/4"
- 25245-21 TC 21 cm, 8 1/4"
- 25245-26 TC 26 cm, 10 1/4"



MASSON

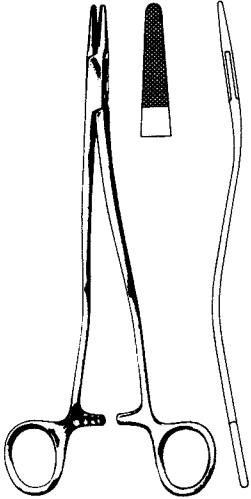
- 25250-27 27 cm, 10 1/2"
- 25254-27 TC 27 cm, 10 1/2"



WANGENSTEEN

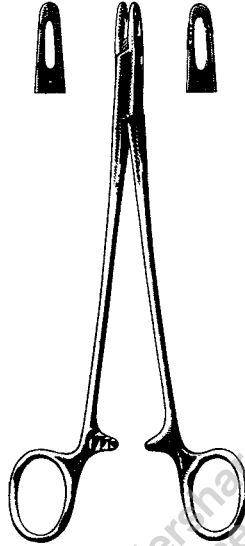
- 25260-27 27 cm, 10 1/2"
- 25264-27 TC 27 cm, 10 1/2"

Nadelhalter
Needle Holders
Porta-agujas
Port'aghi



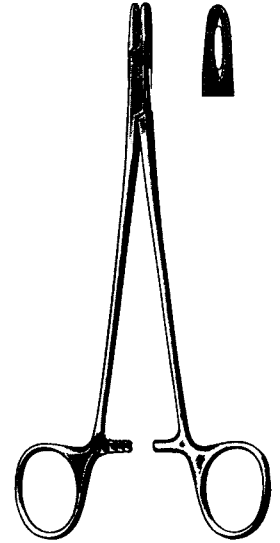
BOZEMANN

25285-20 TC 20 cm, 8"
25285-24 TC 24 cm, 9 1/2"
25285-26 TC 26 cm, 10 1/4"



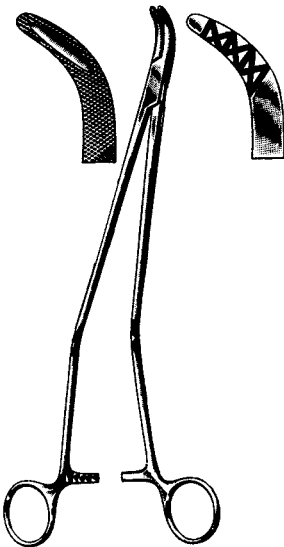
METZENBAUM

25290-18
18 cm, 7"



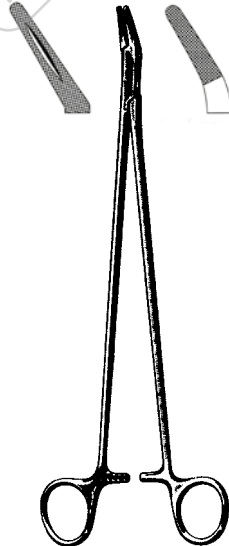
ADSON

25292-18
18 cm, 7"



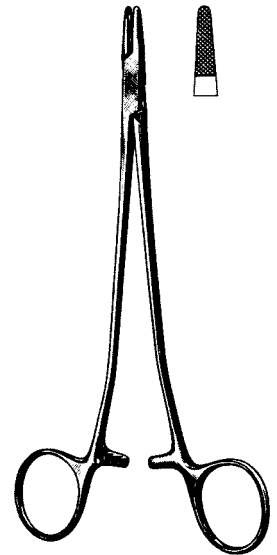
JOHNSON

25293-27
27 cm, 10 1/2"



FINOCHIETTO

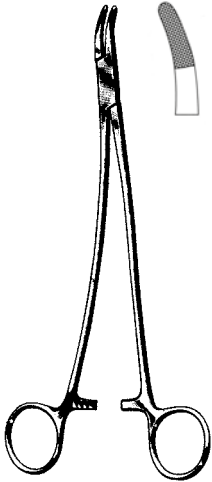
25311-20 20 cm, 8" 25315-20 TC
25311-27 27 cm, 10 1/2" 25315-27 TC



SAROT

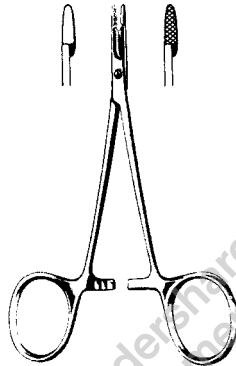
25324-18 TC 18 cm, 7"
25324-26 TC 26 cm, 10 1/4"

Nadelhalter
Needle Holders
Porta-agujas
Port'aghi



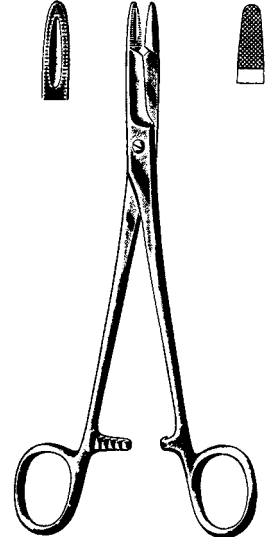
STRATTE

25330-21 21 cm, 8 1/4"
25330-23 23 cm, 9" **25334-23 TC**



BABY-OLSEN-HEGAR

25405-12 25406-12
25408-12 TC 25407-12 TC
11,5 cm, 4 1/2"



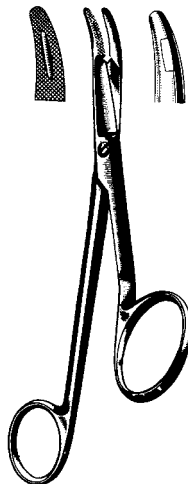
OLSEN-HEGAR

25410-14 14 cm, 5 1/2" **25414-14 TC**
25410-17 17 cm, 6 3/4" **25414-17 TC**
18 cm, 7" **25414-18 TC**



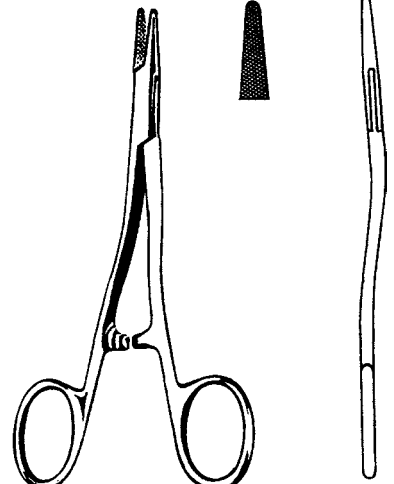
MATHIEU-OLSEN

25415-14 TC 14 cm, 5 1/2"
25415-17 TC 17 cm, 6 3/4"
25415-20 TC 20 cm, 8"



GILLIES

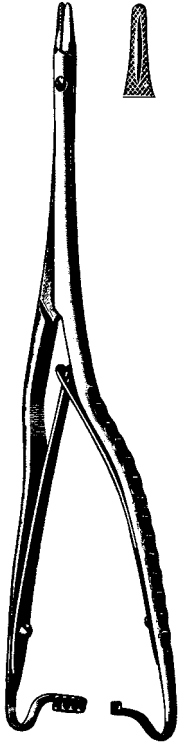
11 cm, 4 3/8" **25434-11 TC**
13 cm, 5 1/8" **25434-13 TC**
25430-16 16 cm, 6 1/4" **25434-16 TC**



KILNER

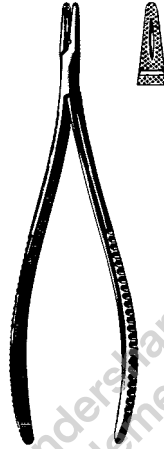
25436-13 13 cm, 5 1/8"
25438-13 TC 13 cm, 5 1/8"

Nadelhalter
Needle Holders
Porta-agujas
Port'aghi



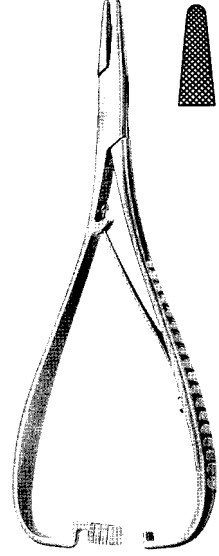
HOESEL

25446-25 25 cm, 10"
25447-25 TC 25 cm, 10"



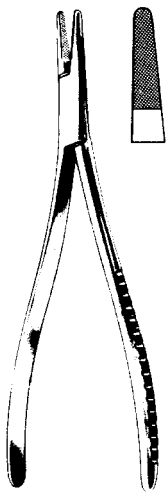
CRILE

25438-15 15 cm, 6"



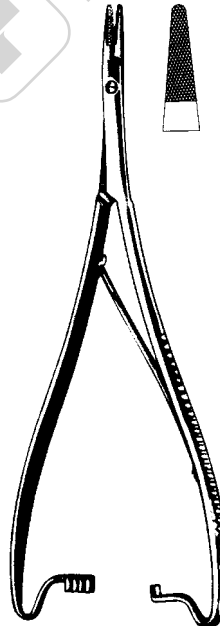
MATHIEU

25450-14 14 cm, 5 1/2" 25452-14 TC
25450-17 17 cm, 6 3/4" 25452-17 TC
25450-20 20 cm, 8" 25452-20 TC
25450-24 24 cm, 9 1/2" 25452-24 TC



LANGENBECK

25460-18 TC 18 cm, 7"
25460-20 TC 20 cm, 8"
25460-23 TC 23 cm, 9"



HOESEL

25465-20 TC 20 cm, 8"
25465-25 TC 25 cm, 10"



LICHTENBERG

25466-17 17 cm, 6 3/4" 25467-17 TC
25466-20 20 cm, 8" 25467-20 TC

Nadelhalter Needle Holders Porta-agujas Port'aghi

Oftalmologie
Ophthalmology
Oftalmologia
Oftalmologia



STEVENS
25610-11
11 cm, 4 3/8"



STEVENS
25612-13 13 cm, 5 1/8"
25612-15 15 cm, 6"



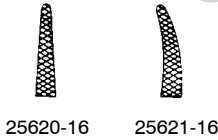
BOYNTON
25614-12
12 cm, 4 3/4"



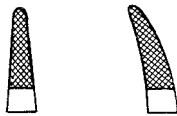
BOYNTON
25615-12 TC
12 cm, 4 3/4"



ARRUGA
25620-16 - 25624-16
16 cm, 6 1/4"



25620-16 25621-16



25624-16 TC **25625-16 TC**



KALT-ARRUGA
25627-14
14 cm, 5 1/2"

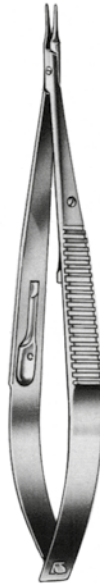


KALT
25628-14
14 cm, 5 1/2"

Nadelhalter
Needle Holders
Porta-agujas
Port'aghi



JACOBSEN
25667-18 18 cm, 7"
25668-18 TC 18 cm, 7"
25667-21 21 cm, 8 1/4"
25668-21 TC 21 cm, 8 1/4"



CASTROVIEJO
14 cm, 5 1/2"



25670-14
glatt
smooth
lisa
liscia



25672-14
gerieft
serrated
estriada
zigrinato



25676-14 TC



25671-14
glatt
smooth
lisa
liscia



25673-14
gerieft
serrated
estriada
zigrinato



25677-14 TC



25678-09



25679-09



CASTROVIEJO-MICRO
9 cm, 3 1/2"



CASTROVIEJO
25680-13 13 cm, 5 1/8"
25684-13 TC 13 cm, 5 1/8"

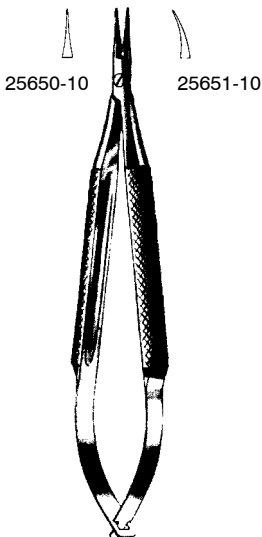
Mikro-Nadelhalter
Micro-Needle Holders
Micro-Porta-agujas
Micro-Port'aghi



CASTROVIEJO-STANDARD
25678-14 14 cm, 5 1/2"



CASTROVIEJO-STANDARD
25679-14 14 cm, 5 1/2"



BARRAQUER
10 cm, 4"

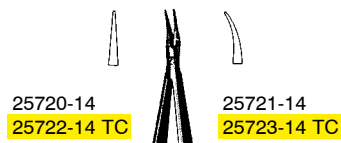


BARRAQUER-TROUTMAN
10 cm, 4"

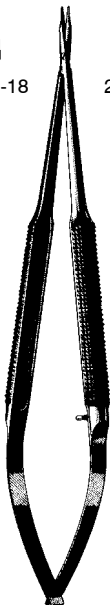
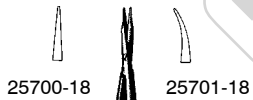
Mikro-Nadelhalter
Micro-Needle Holders
Micro-Porta-agujas
Micro-Port'aghi



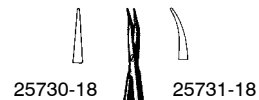
BARRAQUER
13 cm, 5 1/8"



BARRAQUER
14 cm, 5 1/2"



BARRAQUER
18 cm, 7"



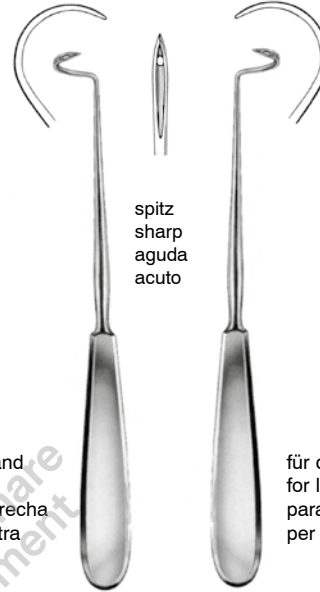
BARRAQUER
18 cm, 7"

Unterbindungsnadeln
Ligature Needles
Agujas para ligaduras
Aghi per legature



biegsam
malleable
maleable
malleabile

27109-20
20 cm, 8"



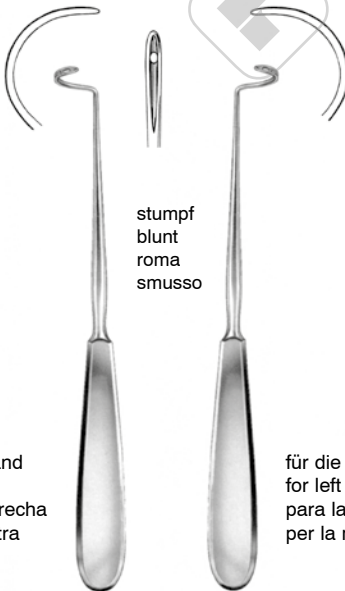
spitz
sharp
aguda
acuto

für die rechte Hand
for right hand
para la mano derecha
per la mano destra

für die linke Hand
for left hand
para la mano izquierda
per la mano sinistra

DESCHAMPS

27110-21	21 cm, 8 1/4"	27111-21
27110-24	24 cm, 9 1/2"	27111-24
27110-27	27 cm, 10 1/2"	27111-27



stumpf
blunt
roma
smusso

für die rechte Hand
for right hand
para la mano derecha
per la mano destra

für die linke Hand
for left hand
para la mano izquierda
per la mano sinistra

DESCHAMPS

27120-21	21 cm, 8 1/4"	27121-21
27120-24	24 cm, 9 1/2"	27121-24
27120-27	27 cm, 10 1/2"	27121-27

Unterbindungsnadeln
Ligature Needles
Agujas para ligaduras
Aghi per legature

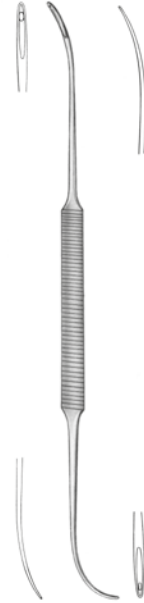
27130-13
fein, für die rechte Hand
delicate, for right hand
fina, para la mano derecha
fino, per la mano destra



stumpf
blunt
roma
smusso

27131-13
fein, für die linke Hand
delicate, for left hand
fina, para la mano izquierda
fino, per la mano sinistra

KRONECKER
13 cm, 5 1/8"



SCHMIEDEN-DICK
27134-32 32 cm, 12 3/4"
biegsam - malleable - maleable - malleabile

27133-24
für die rechte Hand
for right hand
para la mano derecha
per la mano destra



stumpf
blunt
roma
smusso



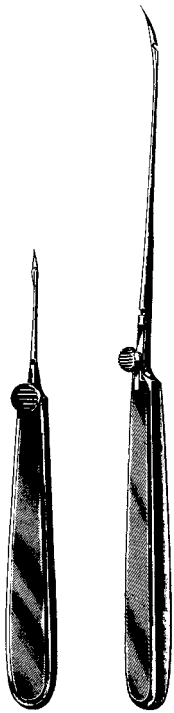
NELSON
24,5 cm, 9 3/4"

27135-24
für die linke Hand
for left hand
para la mano izquierda
per la mano sinistra



COOPER
27139-19 19 cm, 7 1/2"

Nahtinstrumente
 Suturing Instruments
 Instrumentos para suturas
 Strumenti per suture



REVERDIN
 27201-15 - 27204-21



Fig. 1	Fig. 2
27201-15 15 cm, 6"	27202-15 15 cm, 6"
27201-19 19 cm, 7 1/2"	27202-19 19 cm, 7 1/2"
27201-21 21 cm, 8 1/4"	27202-21 21 cm, 8 1/4"



YOUNG BOOMERANG
 27240-00
 25 cm, 10"



Fig. 1
 27240-01



Fig. 2
 27240-02

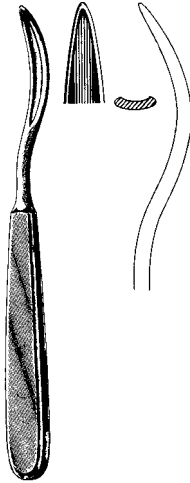


Fig. 3
 27240-03

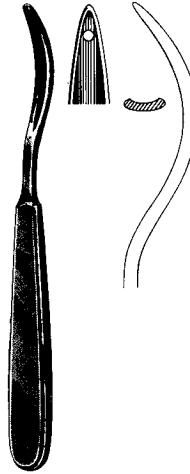


Fig. 3	Fig. 4
27203-15 15 cm, 6"	27204-15 15 cm, 6"
27203-19 19 cm, 7 1/2"	27204-19 19 cm, 7 1/2"
27203-21 21 cm, 8 1/4"	27204-21 21 cm, 8 1/4"

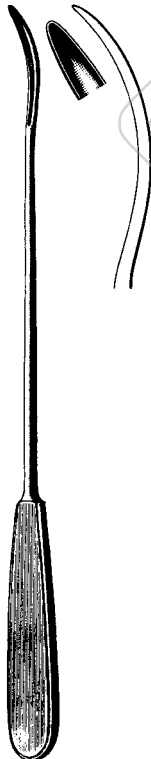
Führungshohlsonden
Ligature Conductors
Sondas conductoras
Sonde conduttrici



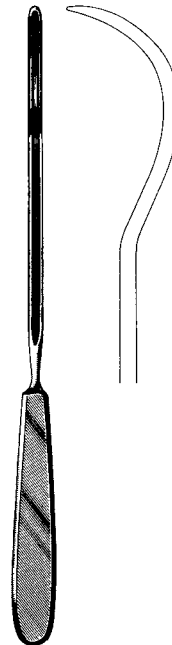
SCHMIEDEN
27271-19 19 cm, 7 1/2"



SCHMIEDEN-PAYR
27273-19 19 cm, 7 1/2"

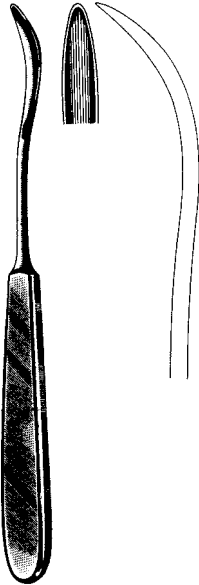


BRUNNER
27275-30 30 cm, 11 3/4"



KIRSCHNER
27277-25 25,5 cm, 10"

Führungshohlsonden, Fadenfänger, Fadengabel
 Ligature Conductors, Ligature Catcher, Ligature Adjuster
 Sondas conductoras, Captador de hilos, Horquilla de hilos
 Sonde conduttrici, Portalegature, Forchetta da sutura



KOENIG
27285-20
20 cm, 8"



PAYR
27288-22
22 cm, 8 3/4"

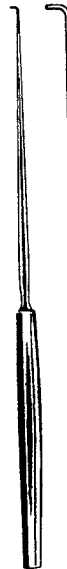


PAYR
27289-22
22 cm, 8 3/4"

Plastik
plastic
plástico



BRUNNER
27291-18 18 cm, 7"
27291-27 27 cm, 10 1/2"



VIENNA
27297-23
23,5 cm, 9 1/4"



HADEO
27298-23
23 cm, 9"



Chirurgische Nadeln
Suturing Needles
Agujas para suturas
Aghi per suture

Pack à 1 Dutzend
in packages of 1 dozen
en sobres de 1 docena
confezione 1 dozzina

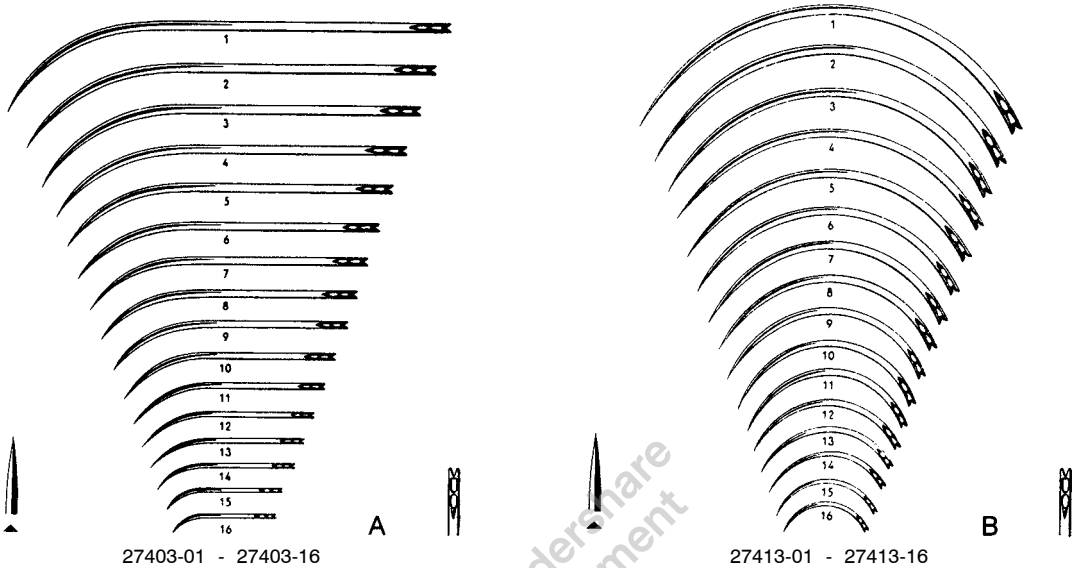


Fig. 1 2 3 4 5 6 7 8 9 10 11 12 13 14 15 16

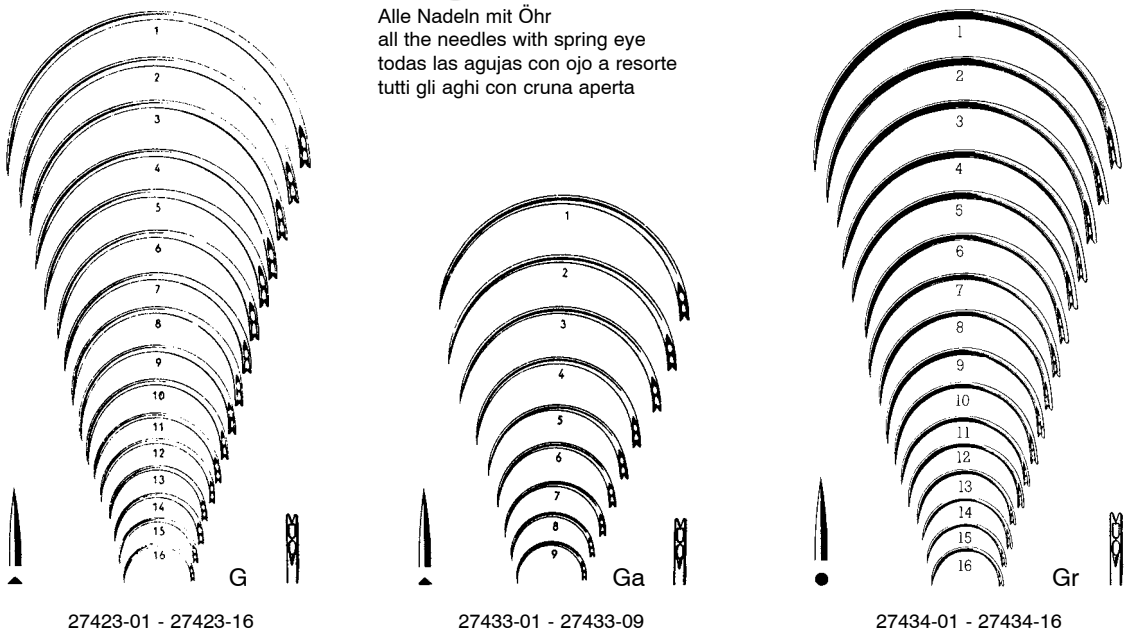
A 27403-01 27403-02 27403-03 27403-04 27403-05 27403-06 27403-07 27403-08 27403-09 27403-10 27403-11 27403-12 27403-13 27403-14 27403-15 27403-16

B 27413-01 27413-02 27413-03 27413-04 27413-05 27413-06 27413-07 27413-08 27413-09 27413-10 27413-11 27413-12 27413-13 27413-14 27413-15 27413-16

G 27423-01 27423-02 27423-03 27423-04 27423-05 27423-06 27423-07 27423-08 27423-09 27423-10 27423-11 27423-12 27423-13 27423-14 27423-15 27423-16

Ga 27433-01 27433-02 27433-03 27433-04 27433-05 27433-06 27433-07 27433-08 27433-09 27433-10 27433-11 27433-12 27433-13 27433-14 27433-15 27433-16

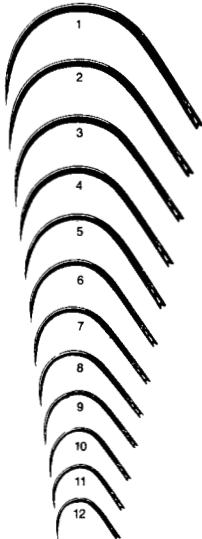
Gr 27434-01 27434-02 27434-03 27434-04 27434-05 27434-06 27434-07 27434-08 27434-09 27434-10 27434-11 27434-12 27434-13 27434-14 27434-15 27434-16



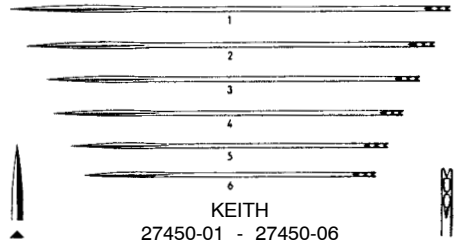
Alle Nadeln mit Öhr
all the needles with spring eye
todas las agujas con ojo a resorte
tutti gli aghi con cruna aperta

Alle Nadeln mit Öhr
all the needles with spring eye
todas las agujas con ojo a resorte
tutti gli aghi con cruna aperta

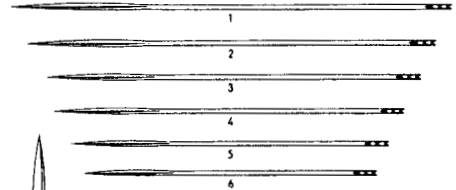
Chirurgische Nadeln
Suturing Needles
Agujas para suturas
Aghi per suture



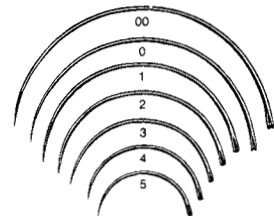
27441-01 - 27441-12



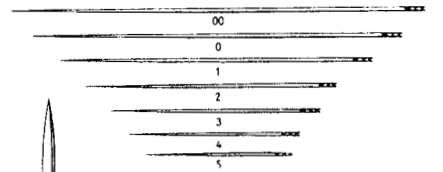
KEITH
27450-01 - 27450-06



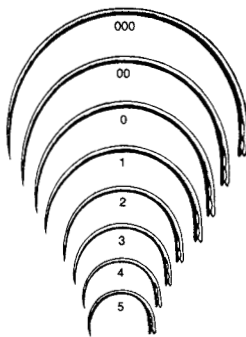
KEITH
27452-01 - 27452-06



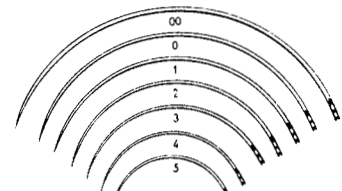
27465-20 - 27467-05 Pb



27475-20 - 27477-05 Pc



27443-30 - 27443-05



27485-20 - 27487-05 Pd

FIG.	000	00	0	1	2	3	4	5	6	7	8	9	10	11	12
KÖNIG				27441-01	27441-02	27441-03	27441-04	27441-05	27441-06	27441-07	27441-08	27441-09	27441-10	27441-11	27441-12
E	27443-30	27443-20	27443-10	27443-01	27443-02	27443-03	27443-04	27443-05							
KEITH				27450-01	27450-02	27450-03	27450-04	27450-05	27450-06						
KEITH					27452-01	27452-02	27452-03	27452-04	27452-05	27452-06					
Pb	27465-20	27465-10	27467-01	27467-02	27467-03	27467-04	27467-05								
Pc	27475-20	27475-10	27477-01	27477-02	27477-03	27477-04	27477-05								
Pd	27485-20	27485-10	27487-01	27487-02	27487-03	27487-04	27487-05								

Wundklammerpinzetten und -zangchen, Wundklammern
 Clip Applying Forceps, Suture Clips
 Pinzas aplicadoras para agrafes, Agrafes de sutura
 Pinze per applicare le agrafe, Agrafe



MICHEL
27610-12
12 cm, 4 3/4"



WACHENFELDT
27612-12
12,5 cm, 5"



WACHENFELDT
27614-12
12,5 cm, 5"



HEGENBARTH
27616-12
12,5 cm, 5"



CHILDE
27620-18
18 cm, 7"



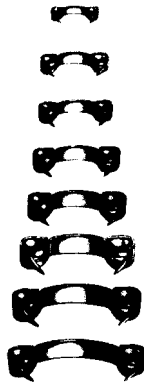
MICHEL
27630-12
12 cm, 4 3/4"



COLLIN
27640-13
13 cm, 5 1/8"



RICHTER-HEATH
27642-14
14 cm, 5 1/2"



MICHEL

- MICHEL mm
- 27660-07 7,5x1,75
- 27660-11 11x2
- 27660-12 12x2,5
- 27660-14 14x3
- 27660-16 16x3
- 27660-18 18x3
- 27660-20 20x3
- 27660-22 22x3

Pack à 1000
 box of 1000
 paq x 1000
 confezione x 1000



Nahtbesteck
Suture Set
Estuche para suturas
Set per sutura



STANDARD

27680-00
165 x 90 x 28 mm

Komplett in Metalletui und Plastiktasche mit 2 herausnehmbaren gelochten Einlagen mit Stegen für Instrumente

Bestehend aus:

- 1 Mathieu Nadelhalter 14 cm (5 $\frac{1}{2}$ ")
- 1 Nähseide in Alkohol
- 6 Nähnadeln sortiert
- 1 Nadeldose gelocht 65 x 42 cm
- 1 Michel Wundklammerzange
- 20 Wundklammern auf Halter
- 1 Skalpellgriff mit Klinge
- 3 Klängen auswechselbar
- 1 Schere st/sp. 13 cm (5") gerade
- 1 anat. Pinzette 11,5 cm (4 $\frac{1}{2}$ ")
- 1 Hakenpinzette 1 x 2 Z. 12 cm (4 $\frac{3}{4}$ ")
- 1 Hunter Splitterpinzette 10,5 cm (4 $\frac{1}{4}$ ")
- 1 Kocher Arterienklemme 13 cm (5")
- 1 Myrtenblattsonde 13 cm (5")

Complete in metal case with plastic pouch and 2 removable perforated trays for instruments

Contents:

- 1 Mathieu Needle Holder, 14 cm (5 $\frac{1}{2}$ ")
- 1 Flacon with sterilized silk in alcohol
- 6 Suture Needles, assorted
- 1 Needle Case, 25.6" x 16.5", perforated
- 1 Michel Suture Clip Forceps
- 20 Michel Suture Clips with Clip Holder
- 1 Scalpel Handle with Blade
- 3 Scalpel Blades, interchangeable
- 1 Scissors, straight, blunt/sharp, 13 cm (5")
- 1 Dressing Forceps, 11,5 cm (4 $\frac{1}{2}$ ")
- 1 Tissue Forceps, 12 cm (4 $\frac{3}{4}$ "), 1 x 2 teeth
- 1 Hunter Splitter Forceps, 10,5 cm (4 $\frac{1}{4}$ ")
- 1 Kocher Artery Forceps, straight, 13 cm (5"), S
- 1 Probe with myrtle leaf, 13 cm (5")

Completo en caja de metal con bolsa de plástico y 2 bandejas perforadas para los instrumentos

Contenido:

- 1 Porta-aguja de Mathieu, 14 cm (5 $\frac{1}{2}$ ")
- 1 Frasco con seda esterilizada para sutura, en alcohol
- 6 Agujas de sutura surtidas
- 1 Cajita para agujas, 65 x 42 mm, perforada
- 1 Pinza para agrafes de Michel
- 20 Agrafes de Michel, en su porta-agrafe
- 1 Mango de bisturi, con hoja intercambiable
- 3 Hojas intercambiables surtidas
- 1 Tijera, recta, roma/aguda, 13 cm (5")
- 1 Pinza de disección, 11,5 cm (4 $\frac{1}{2}$ ")
- 1 Pinza de disección, con 1 x 2 dientes, 12 cm (4 $\frac{3}{4}$ ")
- 1 Pinza para espinas de Hunter, 10,5 cm (4 $\frac{1}{4}$ ")
- 1 Pinza hemostática de Kocher, 13 cm (5"), S.
- 1 Estilete abotonado, multiforme, 13 cm (5")

Astuccio tascabile con due supporti estraibili

Contenente:

- 1 Port aghi di Mathieu 14 cm (5 $\frac{1}{2}$ ")
- 1 Set per sutura in flacone di vetro
- 6 aghi per sutura assortiti
- 1 scatola per aghi 65 x 24 perforata
- 1 pinza per sutura di Michel
- 20 Agrafe Michel ed porta agrafe
- 1 Manico da bisturi per lama intercambiabile
- 3 lame da bisturi intercambiabili
- 1 forbici rette alterne 13 cm (5")
- 1 pinze da dissezione
- 1 pinze da dissezione 1 x 2 denti
- 1 pinze di Hunter per schegge 10,5 cm (4 $\frac{1}{4}$ ")
- 1 pinze emostatiche di Kocher 13 cm (5")
- 1 specillo bottonuto 13 cm (5")

Sterilisierzangen, Abfallzange, Sterilisierklammern
 Sterilization Instruments, Waste Forceps, Safety pins
 Instrumentos para la esterilización, Pinza para desechos, Cadres de estérilización,
 Pinze per la sterilizzazione, Pinza per rifiuti, Spilloni p. sterilizzazione



DAVIS

29102-16 16 cm, 6 1/4"
 29102-20 20 cm, 8"
 29102-24 24 cm, 9 1/2"



CHEATTLE

29110-27
 27 cm, 10 1/2"



UNIVERSAL

29120-20 20 cm, 8" 29121-20
 29120-28 28 cm, 11" 29121-28



ROGGE

29130-23
 23 cm, 9"



29140-20 20 cm, 8"
 29140-30 30 cm, 11 3/4"



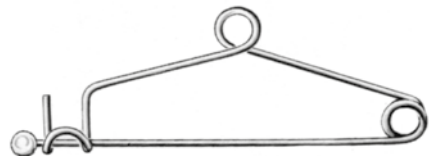
SAUERBRUCH

29145-55
 55 cm, 21.7"



BUNT

29150-12 12 cm, 4 3/4"

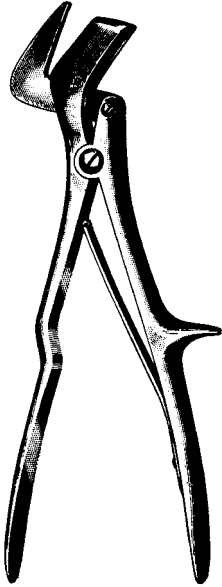


MAYO

29152-14 14 cm, 5 1/2"



Gipsscheren
Plaster of Paris Shears
Cizallas para vendajes enyesados
Cesoie per gessi



STILLE
31101-24 24 cm, 9 1/2"

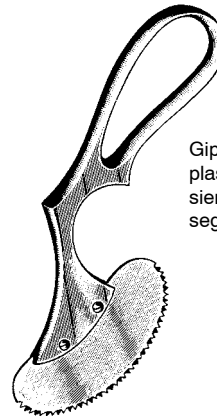


STILLE
31103-23 23 cm, 9"
31103-26 26 cm, 10 1/4"
31103-37 37 cm, 14 1/2"



Gipsmesser
plaster knife
cuchillo para vendajes enyesados
coltello da gesso

WIGMORE
31120-19 19 cm, 7 1/2"



Gipssäge
plaster saw
sierra para vendajes enyesados
sega da gesso

ENGEL
31130-14 16 cm, 6 1/4"
verchromt, chrome plated

Autopsiesäge
Autopsy saw
Sierra para autopsia
Sega per autopsia

Geräuschpegel: 52 - 77 db (A)
Noise level: 52 - 77 db (A)
Nivel de ruido del aparato sólo: 52 - 77 db (A)
Livello acustico dello strumento solo: 52 - 77 db (A)

6500-24000 Schwingungen pro Minute
6500-24000 oscillations per minute
6500-24000 oscilaciones por minuto
6500-24000 oscillazioni al minute

EN 60601-1, EN 60601-1-2, IEC 60601-1, IEC 60601-1-2



31201-01 120 Volt, 500 Watt, 1,5 kg

31201-02 230 Volt, 500 Watt, 1,5 kg

31201-01 + 31201-02 inklusive, inclusive, inclusive, inclusive:

- 1x 31210-50 Ø 50mm Sägeblatt, saw blade, hoja de repuesto, lama per sega
- 1x 31210-65 Ø 65mm Sägeblatt, saw blade, hoja de repuesto, lama per sega
- 1x 31204-01 Ø 50/65mm Segment-Sägeblatt, segment saw blade, hoja de repuesto para segmento, lama per sega a segmento
- 1x 31202-16 Inbusschlüssel T-Griff, alan key with T-handle, llave hexagonal con mango de T, chiave esagonale con manico a T
- 1x 31200-95 Spritze, gefüllt mit Fett, injection filled with fat, jeringa rellena con grasa, siringa colmata con grassa
- 1x 31212-02 Paar Gabelschlüssel, pair flat wrench, pareja llave de boca, paio chiave a bocca, 11mm

Zubehör für Autopsiesäge 31201-02 und 31201-01 siehe Seite 230/14 - 230/18
Accessories for Autopsy saw 31201-02 and 31201-01 please see page 230/14 - 230/18
Accesorios para sierra para autopsia 31201-02 y 31201-01 vea la página 230/14 - 230/18
Accessorio per sega per autopsia 31201-02 e 31201-01 vedi pagina 230/14 - 230/18

31210-45	Ø 45mm	Sägeblatt, saw blade, hoja de repuesto, lama per sega
31210-50	Ø 50mm	Sägeblatt, saw blade, hoja de repuesto, lama per sega
31210-65	Ø 65mm	Sägeblatt, saw blade, hoja de repuesto, lama per sega
31204-01	Ø 50/65mm	Segment-Sägeblatt, segment saw blade, hoja de repuesto para segmento, lama per sega a segmento
31204-03	Ø 65/65mm	Segment-Sägeblatt, segment saw blade, hoja de repuesto para segmento, lama per sega a segmento
31205-08	8mm	Tiefen-Sägeblatt, deep cutting saw, hoja de sierra de profundidad, lama a taglio di profondità
31205-20	20mm	Tiefen-Sägeblatt, deep cutting saw, hoja de sierra de profundidad, lama a taglio di profondità
31203-50		Begrenzungsscheibe, limiting disc, disco de tope, disco eccentrico
31202-16		Inbusschlüssel T-Griff, alan key with T-handle, llave hexagonal con mango de T, chiave esagonale con manico a T
31200-95		Spritze gefüllt mit Fett, injection filled with fat, jeringa rellena con grasa, siringa colmata con grassa
31212-02		1 Paar Gabelschlüssel, pair flat wrench, pareja llave de boca, paio chiave a bocca, 11mm

Autopsiesäge
Autopsy saw
Sierra para autopsia
Sega per autopsia

Geräuschpegel: 52 - 77 db (A)
Noise level: 52 - 77 db (A)
Nivel de ruido del aparato sólo: 52 - 77 db (A)
Livello acustico dello strumento solo: 52 - 77 db (A)

6500-24000 Schwingungen pro Minute
6500-24000 oscillations per minute
6500-24000 oscilaciones por minuto
6500-24000 oscillazioni al minute

EN 60601-1, EN 60601-1-2, IEC 60601-1, IEC 60601-1-2



Dreikantschaft
Three-jaw chuck
Mandril de tres mordazas
Mandrino con tre ganasce



31201-11 120 Volt, 500 Watt, 1,5 kg

31201-22 230 Volt, 500 Watt, 1,5 kg

31201-11 + 31201-22 inklusive, inclusive, inclusive, inclusive:

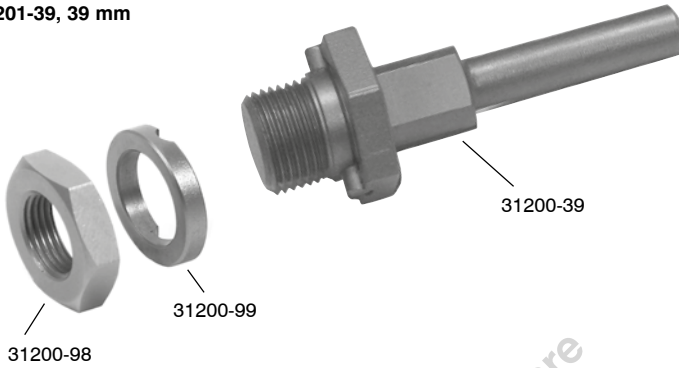
- | | | |
|-------------|-----------|---|
| 31201-39 | 39mm | Schaft komplett, Arbor complete, Vastago completo, Asta completa |
| 1x 31210-50 | Ø 50mm | Sägeblatt, saw blade, hoja de repuesto, lama per sega |
| 1x 31210-65 | Ø 65mm | Sägeblatt, saw blade, hoja de repuesto, lama per sega |
| 1x 31204-01 | Ø 50/65mm | Segment-Sägeblatt, segment saw blade, hoja de repuesto para segmento, lama per sega a segmento |
| 1x 31202-16 | | Inbusschlüssel T-Griff, alan key with T-handle, llave hexagonal con mango de T, chiave esagonale con manico a T |
| 1x 31200-95 | | Spritze gefüllt mit Fett, injection filled with fat, jeringa rellena con grasa, siringa colmata con grassa |
| 1x 31202-14 | | Paar Gabelschlüssel, pair flat wrench, pareja llave de boca, paio chiave a bocca, 14mm |

Zubehör für Autopsiesäge 31201-22 und 31201-11 siehe Seite 230/14 - 230/18
Accessories for Autopsy saw 31201-22 and 31201-11 please see page 230/14 - 230/18
Accesorios para sierra para autopsia 31201-22 y 31201-11 vea la página 230/14 - 230/18
Accessorio per sega per autopsia 31201-22 e 31201-11 vedi pagina 230/14 - 230/18

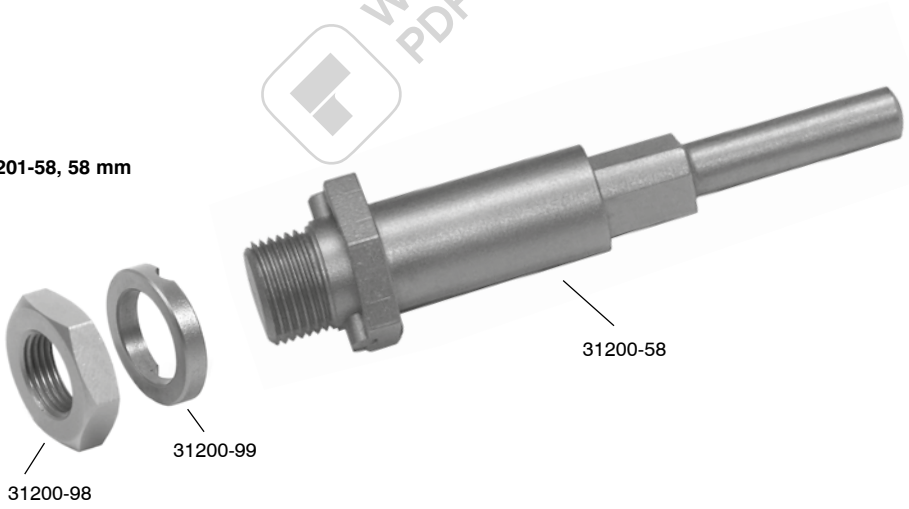
31210-45	Ø 45mm	Sägeblatt, saw blade, hoja de repuesto, lama per sega
31210-50	Ø 50mm	Sägeblatt, saw blade, hoja de repuesto, lama per sega
31210-65	Ø 65mm	Sägeblatt, saw blade, hoja de repuesto, lama per sega
31204-01	Ø 50/65mm	Segment-Sägeblatt, segment saw blade, hoja de repuesto para segmento, lama per sega a segmento
31204-03	Ø 65/65mm	Segment-Sägeblatt, segment saw blade, hoja de repuesto para segmento, lama per sega a segmento
31205-08	8mm	Tiefen-Sägeblatt, deep cutting saw, hoja de sierra de profundidad, lama a taglio di profondità
31205-20	20mm	Tiefen-Sägeblatt, deep cutting saw, hoja de sierra de profundidad, lama a taglio di profondità
31203-50		Begrenzungsscheibe, limiting disc, disco de tope, disco eccentrico
31202-16		Inbusschlüssel T-Griff, alan key with T-handle, llave hexagonal con mango de T, chiave esagonale con manico a T
31200-95		Spritze gefüllt mit Fett, injection filled with fat, jeringa rellena con grasa, siringa colmata con grassa
31202-14		1 Paar Gabelschlüssel, pair flat wrench, pareja llave de boca, paio chiave a bocca, 14mm

Zubehör zur Autopsiesäge
Accessories for Autopsy saw
Accesorio para la sierra de autopsia
Accessori per sega per autopsia

31201-39, 39 mm



31201-58, 58 mm



Wondershare
PDFelement

Zubehör zur Autopsiesäge
Accessories for Autopsy saw
Accesorio para la sierra de autopsia
Accessori per sega per autopsia

Set 31203-10



Set 31203-10: 31201-39 + 31210-65

Set 31203-00: 31201-39 + 31210-50

Set 31203-20: 31201-58 + 31210-50

Set 31203-30: 31201-58 + 31210-65

Set 31204-00



Set 31204-00: 31201-39 + 31204-01

Set 31204-10: 31201-39 + 31204-03

Set 31204-20: 31201-58 + 31204-01

Set 31204-30: 31201-58 + 31204-03

Zubehör zur Autopsiesäge
 Accessories for Autopsy saw
 Accesorio para la sierra de autopsia
 Accessori per sega per autopsia

Set 31205-00



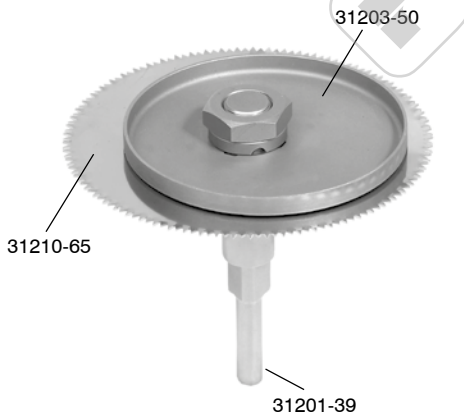
Set 31205-00: 31201-39 + 31205-20

Set 31206-00: 31201-39 + 31205-08

Set 31206-10: 31201-58 + 31205-08

Set 31205-10: 31201-58 + 31205-20

Set 31210-10

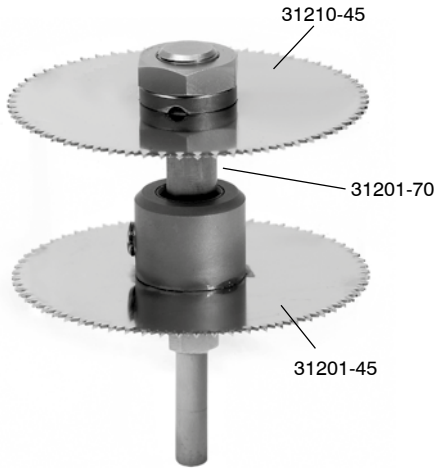


Set 31210-10: 31201-39 + 31210-65 + 31203-50

Set 31210-00: 31201-58 + 31210-65 + 31203-50

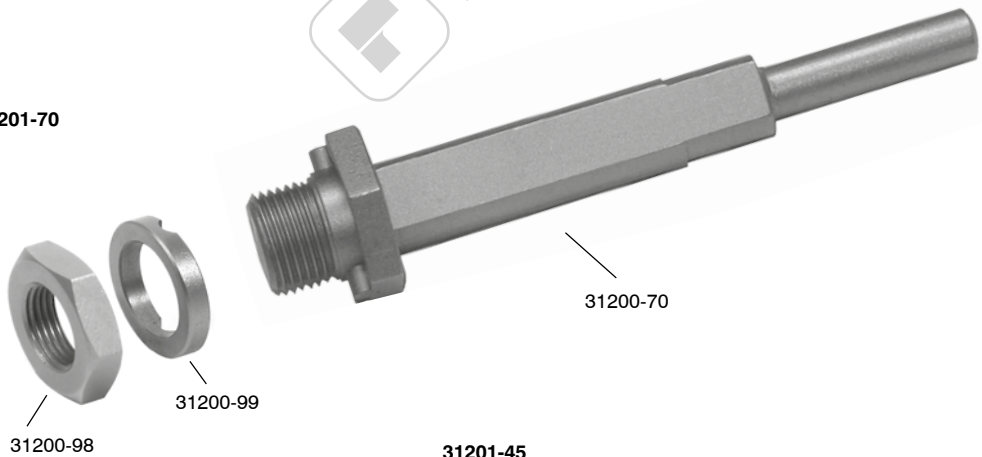
Zubehör zur Autopsiesäge
 Accessories for Autopsy saw
 Accesorio para la sierra de autopsia
 Accessori per sega per autopsia

Set 31202-00

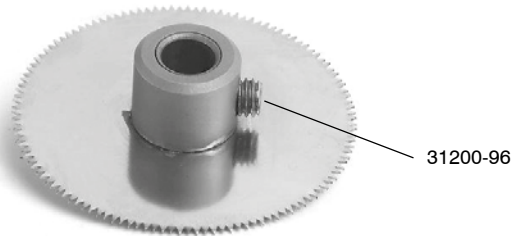


Set 31202-00: 31201-70 + 31210-45 + 31201-45

31201-70



31201-45



Zubehör für Autopsiesäge 31201-22 und 31201-11 siehe Seite 230/4 - 230/7
 Accessories for Autopsy saw 31201-22 and 31201-11 please see page 230/4 - 230/7
 Accesorios para sierra para autopsia 31201-22 y 31201-11 vea la página 230/4 - 230/7
 Accessorio per sega per autopsia 31201-22 e 31201-11 vedi pagina 230/4 - 230/7

31200-39	Schaft 39mm allein
31201-39	Schaft 39mm komplett
31203-00	Schaft 39mm komplett + Sägeblatt Ø 50mm
31203-10	Schaft 39mm komplett + Sägeblatt Ø 65mm
31204-00	Schaft 39mm komplett + Segmentsägeblatt 50/65mm
31204-10	Schaft 39mm komplett + Segmentsägeblatt 65/65mm
31210-10	Schaft 39mm komplett + Sägeblatt Ø 65mm + Begrenzungsscheibe
31206-00	Schaft 39mm komplett + Tiefensägeblatt 8mm
31205-00	Schaft 39mm komplett + Tiefensägeblatt 20mm
31200-58	Schaft 58mm allein
31201-58	Schaft 58mm komplett
31203-20	Schaft 58mm komplett + Sägeblatt Ø 50mm
31203-30	Schaft 58mm komplett + Sägeblatt Ø 65mm
31204-20	Schaft 58mm komplett + Segmentsägeblatt 50/65mm
31204-30	Schaft 58mm komplett + Segmentsägeblatt 65/65mm
31210-00	Schaft 58mm komplett + Sägeblatt Ø 65mm + Begrenzungsscheibe
31206-10	Schaft 58mm komplett + Tiefensägeblatt 8mm
31205-10	Schaft 58mm komplett + Tiefensägeblatt 20mm
31200-70	Schaft Doppelsäge allein
31201-70	Schaft Doppelsäge komplett
31202-00	Schaft Doppelsäge komplett + Sägeblatt Ø 45mm + verstellbares Sägeblatt Ø 45mm
31201-45	verstellbares Sägeblatt Ø 45mm komplett
31200-96	Inbusmadenschraube für verstellbares Sägeblatt Ø 45mm komplett
31200-98	Mutter für Schaft
31200-99	Sperrring für Schaft
31200-39	Arbor 39mm only
31201-39	Arbor 39mm complete
31203-00	Arbor 39mm complete + saw blade Ø 50mm
31203-10	Arbor 39mm complete + saw blade Ø 65mm
31204-00	Arbor 39mm complete + segment saw blade 50/65mm
31204-10	Arbor 39mm complete + segment saw blade 65/65mm
31210-10	Arbor 39mm complete + saw blade Ø 65mm + limiting disc
31206-00	Arbor 39mm complete + deep cutting saw 8mm
31205-00	Arbor 39mm complete + deep cutting saw 20mm
31200-58	Arbor 58mm only
31201-58	Arbor 58mm complete
31203-20	Arbor 58mm complete + saw blade Ø 50mm
31203-30	Arbor 58mm complete + saw blade Ø 65mm
31204-20	Arbor 58mm complete + segment saw blade 50/65mm
31204-30	Arbor 58mm complete + segment saw blade 65/65mm
31210-00	Arbor 58mm complete + saw blade Ø 65mm + limiting disc
31206-10	Arbor 58mm complete + deep cutting saw 8mm
31205-10	Arbor 58mm complete + deep cutting saw 20mm
31200-70	Double saw only
31201-70	Double saw complete
31202-00	Double saw complete + saw blade Ø 45mm + adjustable saw blade Ø 45mm
31201-45	Adjustable saw blade Ø 45mm complete
31200-96	Allen screw for adjustable saw blade Ø 45mm complete
31200-98	Nut for arbor
31200-99	Blocking ring for arbor

Zubehör für Autopsiesäge 31201-22 und 31201-11 siehe Seite 230/4 - 230/7
 Accessories for Autopsy saw 31201-22 and 31201-11 please see page 230/4 - 230/7
 Accesorios para sierra para autopsia 31201-22 y 31201-11 vea la página 230/4 - 230/7
 Accessorio per sega per autopsia 31201-22 e 31201-11 vedi pagina 230/4 - 230/7

31200-39	Vastago 39mm suelto
31201-39	Vastago 39mm completo
31203-00	Vastago 39mm completo + hoja de repuesto Ø 50mm
31203-10	Vastago 39mm completo + hoja de repuesto Ø 65mm
31204-00	Vastago 39mm completo + hoja de repuesto para segmento 50/65mm
31204-10	Vastago 39mm completo + hoja de repuesto para segmento 65/65mm
31210-10	Vastago 39mm completo + hoja de repuesto Ø 65mm + disco de tope
31206-00	Vastago 39mm completo + hoja de sierra de profundidad 8mm
31205-00	Vastago 39mm completo + hoja de sierra de profundidad 20mm
31200-58	Vastago 58mm suelto
31201-58	Vastago 58mm completo
31203-20	Vastago 58mm completo + hoja de repuesto Ø 50mm
31203-30	Vastago 58mm completo + hoja de repuesto Ø 65mm
31204-20	Vastago 58mm completo + hoja de repuesto para segmento 50/65mm
31204-30	Vastago 58mm completo + hoja de repuesto para segmento 65/65mm
31210-00	Vastago 58mm completo + hoja de repuesto Ø 65mm + disco de tope
31206-10	Vastago 58mm completo + hoja de sierra de profundidad 8mm
31205-10	Vastago 58mm completo + hoja de sierra de profundidad 20mm
31200-70	Doble sierra suelta
31201-70	Doble sierra completa
31202-00	Doble sierra completa + hoja de repuesto Ø 45mm + hoja de sierra ajustable Ø 45mm
31201-45	hoja de sierra ajustable Ø 45mm completa
31200-96	ornillo con hembra hexagonal para hoja de sierra ajustable Ø 45mm completa
31200-98	tuerca para vastago
31200-99	anillo de recambio para vastago
31200-39	Asta 39mm sola
31201-39	Asta 39mm completa
31203-00	Asta 39mm completa + lama per sega Ø 50mm
31203-10	Asta 39mm completa + lama per sega Ø 65mm
31204-00	Asta 39mm completa + lama per sega a segmento 50/65mm
31204-10	Asta 39mm completa + lama per sega a segmento 65/65mm
31210-10	Asta 39mm completa + lama per sega Ø 65mm + disco eccentrico
31206-00	Asta 39mm completa + lama a taglio di profondità 8mm
31205-00	Asta 39mm completa + lama a taglio di profondità 20mm
31200-58	Asta 58mm sola
31201-58	Asta 58mm completa
31203-20	Asta 58mm completa + lama per sega Ø 50mm
31203-30	Asta 58mm completa + lama per sega Ø 65mm
31204-20	Asta 58mm completa + lama per sega a segmento 50/65mm
31204-30	Asta 58mm completa + lama per sega a segmento 65/65mm
31210-00	Asta 58mm completa + lama per sega Ø 65mm + disco eccentrico
31206-10	Asta 58mm completa + lama a taglio di profondità 8mm
31205-10	Asta 58mm completa + lama a taglio di profondità 20mm
31200-70	Sega a doppia lama sola
31201-70	Sega a doppia lama completa
31202-00	Sega a doppia lama completa + lama per sega Ø 45mm + lame per sega regolabile Ø 45mm
31201-45	lame per sega regolabile Ø 45mm completa
31200-96	ornillo con hembra hexagonal para hoja de sierra ajustable Ø 45mm completa
31200-98	brugola per asta
31200-99	anello di ricambio per asta

Oszillierende Gipsäge
Oscillating Plaster Saw
Sierra oscilante p. vendajes enyesados
Sega oscillante per gessi

Geräuschpegel: 52 - 77 db (A)
Noise level: 52 - 77 db (A)
Nivel de ruido del aparato sólo: 52 - 77 db (A)
Livello acustico dello strumento solo: 52 - 77 db (A)

6500-24000 Schwingungen pro Minute
6500-24000 oscillations per minute
6500-24000 oscilaciones por minuto
6500-24000 oscillazioni al minute

EN 60601-1, EN 60601-1-2, IEC 60601-1, IEC 60601-1-2



31210-21 120 Volt, 500 Watt, 1,5 kg

31210-22 230 Volt, 500 Watt, 1,5 kg

31210-21 + 31210-22 inklusive, inclusive, inclusive, inclusive:

1x 31210-50 Ø 50mm Sägeblatt, saw blade, hoja de repuesto, lama per sega

1x 31210-65 Ø 65mm Sägeblatt, saw blade, hoja de repuesto, lama per sega

1x 31212-02 Paar Gabelschlüssel, pair flat wrench, pareja llave de boca, paio chiave a bocca, 11mm

Zubehör für oszillierende Gipssäge 31210-22 und 31210-21 siehe Seite 230/14 - 230/18
 Accessories for oscillating plaster saw 31210-22 and 31210-21 please see page 230/14 - 230/18
 Accesorios p. sierra oscilante p. vendajes enyesados 31210-22 y 31210-21 vea la página 230/14 - 230/18
 Accessorio per sega oscillante per gessi 31210-22 e 31210-21 vedi pagina 230/14 - 230/18

- 31212-02 1 Paar Gabelschlüssel, pair flat wrench, pareja llave de boca, paio chiave a bocca, 11mm
 31210-30 Koffer, case, maleta, valigia

Naturgipsverbände / bandage / vendajes enyesados / bandaggio in gesso

- 31210-45 Ø 45mm Sägeblatt, saw blade, hoja de repuesto, lama per sega
 31210-50 Ø 50mm Sägeblatt, saw blade, hoja de repuesto, lama per sega
 31210-65 Ø 65mm Sägeblatt, saw blade, hoja de repuesto, lama per sega
 31204-01 Ø 50/65mm Segment-Sägeblatt, segment saw blade, hoja de repuesto para segmento, lama per sega a segmento
 31204-03 Ø 65/65mm Segment-Sägeblatt, segment saw blade, hoja de repuesto para segmento, lama per sega a segment
 31205-08 8mm Tiefen-Sägeblatt, deep cutting saw, hoja de sierra de profundidad, lama a taglio di profondità
 31205-20 20mm Tiefen-Sägeblatt, deep cutting saw, hoja de sierra de profundidad, lama a taglio di profondità

synthetische Hartverbände / synthetic bandage / vendajes sinteticos / bandaggio sintetico

- 31211-45 Ø 45mm Sägeblatt, saw blade, hoja de repuesto, lama per sega
 31211-50 Ø 50mm Sägeblatt, saw blade, hoja de repuesto, lama per sega
 31211-65 Ø 65mm Sägeblatt, saw blade, hoja de repuesto, lama per sega
 31204-02 Ø 50/65mm Segment-Sägeblatt, segment saw blade, hoja de repuesto para segmento, lama per sega a segmento
 31204-04 Ø 65/65mm Segment-Sägeblatt, segment saw blade, hoja de repuesto para segmento, lama per sega a segment
 31205-09 8mm Tiefen-Sägeblatt, deep cutting saw, hoja de sierra de profundidad, lama a taglio di profondità
 31205-21 20mm Tiefen-Sägeblatt, deep cutting saw, hoja de sierra de profundidad, lama a taglio di profondità

PTFE synthetische Hartverbände / PTFE synthetic bandage / PTFE vendajes sinteticos / PTFE bandaggio sintetico

- 31212-50 Ø 50mm Sägeblatt, saw blade, hoja de repuesto, lama per sega
 31212-65 Ø 65mm Sägeblatt, saw blade, hoja de repuesto, lama per sega

Naturgipsverbände und synthetische Hartverbände / Bandage and synthetic bandage / Vendajes enyesados y vendajes sinteticos / Bandaggio in gesso e bandaggio sintetico

- 31203-50 Begrenzungsscheibe, limiting disc, disco de tope, disco eccentrico

Oszillierende Gipsäge
Oscillating Plaster Saw
Sierra oscilante p. vendajes enyesados
Sega oscillante per gessi

Geräuschpegel: 52 - 77 db (A)
Noise level: 52 - 77 db (A)
Nivel de ruido del aparato sólo: 52 - 77 db (A)
Livello acustico dello strumento solo: 52 - 77 db (A)

10000-19000 Schwingungen pro Minute
10000-19000 oscillations per minute
10000-19000 oscilaciones por minuto
10000-19000 oscillazioni al minute

EN 60601-1, EN 60601-1-2, IEC 60601-1, IEC 60601-1-2



Blue Power

31220-21	120 Volt, 210 Watt, 1,25 kg
31220-22	230 Volt, 210 Watt, 1,25 kg

31220-21 + 31220-22 inklusive, inclusive, inclusive, inclusive:

- 1x 31210-50 Ø 50mm Sägeblatt, saw blade, hoja de repuesto, lama per sega
- 1x 31210-65 Ø 65mm Sägeblatt, saw blade, hoja de repuesto, lama per sega
- 1x 31212-02 Paar Gabelschlüssel, pair flat wrench, pareja llave de boca, paio chiave a bocca, 11mm

Zubehör für oszillierende Gipssäge 31220-22 und 31220-21 siehe Seite 231/2
 Accessories for oscillating plaster saw 31220-22 and 31220-21 please see page 231/2
 Accesorios p. sierra oscilante p. vendajes enyesados 31220-22 y 31220-21 vea la página 231/2
 Accessorio per sega oscillante per gessi 31220-22 e 31220-21 vedi pagina 231/2

31212-02	1 Paar Gabelschlüssel, pair flat wrench, pareja llave de boca, paio chiave a bocca, 11mm
31210-30	Koffer, case, maleta, valigia
31220-99	Filtervlies, woven filter, filtro de vellón, filtro vello 10 Stück, 10 pieces, 10 piezas, 10 pezzi

Naturgipsverbände / bandage / vendajes enyesados / bandaggio in gesso

31210-45	Ø 45mm	Sägeblatt, saw blade, hoja de repuesto, lama per sega
31210-50	Ø 50mm	Sägeblatt, saw blade, hoja de repuesto, lama per sega
31210-65	Ø 65mm	Sägeblatt, saw blade, hoja de repuesto, lama per sega
31204-01	Ø 50/65mm	Segment-Sägeblatt, segment saw blade, hoja de repuesto para segmento, lama per sega a segmento
31204-03	Ø 65/65mm	Segment-Sägeblatt, segment saw blade, hoja de repuesto para segmento, lama per sega a segment
31205-08	8mm	Tiefen-Sägeblatt, deep cutting saw, hoja de sierra de profundidad, lama a taglio di profondità
31205-20	20mm	Tiefen-Sägeblatt, deep cutting saw, hoja de sierra de profundidad, lama a taglio di profondità

synthetische Hartverbände / synthetic bandage / vendajes sinteticos / bandaggio sintetico

31211-45	Ø 45mm	Sägeblatt, saw blade, hoja de repuesto, lama per sega
31211-50	Ø 50mm	Sägeblatt, saw blade, hoja de repuesto, lama per sega
31211-65	Ø 65mm	Sägeblatt, saw blade, hoja de repuesto, lama per sega
31204-02	Ø 50/65mm	Segment-Sägeblatt, segment saw blade, hoja de repuesto para segmento, lama per sega a segmento
31204-04	Ø 65/65mm	Segment-Sägeblatt, segment saw blade, hoja de repuesto para segmento, lama per sega a segment
31205-09	8mm	Tiefen-Sägeblatt, deep cutting saw, hoja de sierra de profundidad, lama a taglio di profondità
31205-21	20mm	Tiefen-Sägeblatt, deep cutting saw, hoja de sierra de profundidad, lama a taglio di profondità

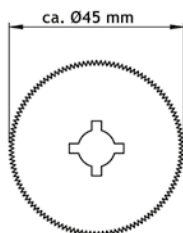
PTFE synthetische Hartverbände / PTFE synthetic bandage / PTFE vendajes sinteticos / PTFE bandaggio sintetico

31212-50	Ø 50mm	Sägeblatt, saw blade, hoja de repuesto, lama per sega
31212-65	Ø 65mm	Sägeblatt, saw blade, hoja de repuesto, lama per sega

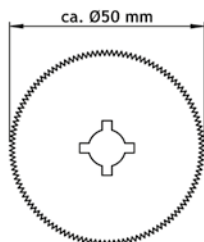
Naturgipsverbände und synthetische Hartverbände / Bandage and synthetic bandage / Vendajes enyesados y vendajes sinteticos / Bandaggio in gesso e bandaggio sintetico

31203-50	Begrenzungsscheibe, limiting disc, disco de tope, disco eccentrico
----------	--

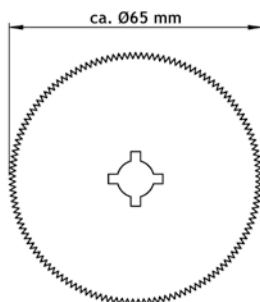
Sägeblätter
Saw blades
Hojas de repuesto
Lame per sega



31210-45
31211-45



31210-50
31211-50
31212-50

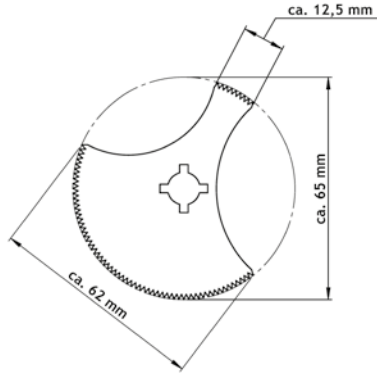


31210-65
31211-65
31212-65

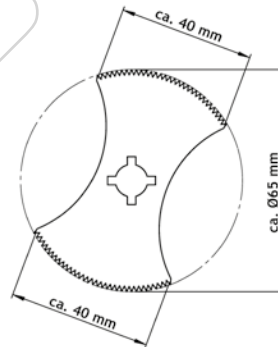
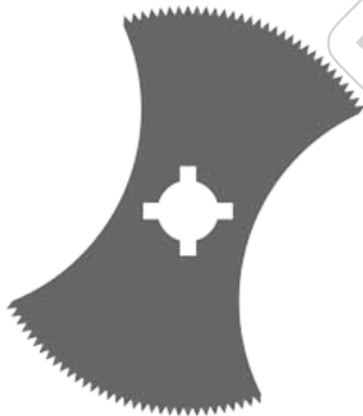


Wondershare
PDFelement

Segment-Sägeblätter
Segment saw blades
Hojas de repuesto para segmento,
Lame per sega a segment

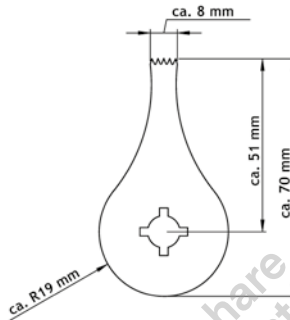


31204-01 Ø 50/65mm
31204-02 Ø 50/65mm

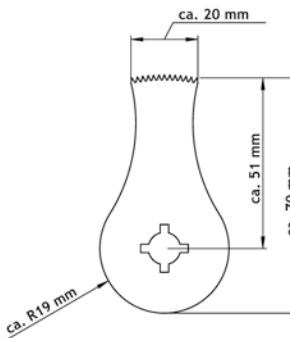


31204-03 Ø 65/65mm
31204-04 Ø 65/65mm

Tiefen-Sägeblätter
 deep cutting saw
 Hojas de sierra de profundidad,
 Lame a taglio di profondità



31205-08 8mm
 31205-09 8mm



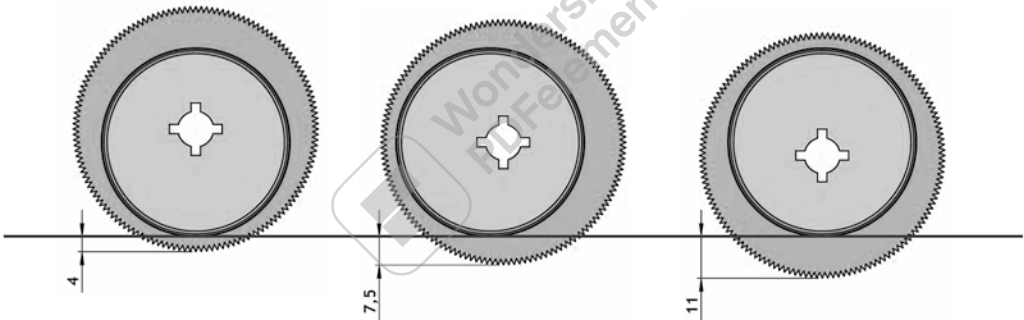
31205-20 20mm
 31205-21 20mm

Sägeblätter
Saw blades
Hojas de repuesto
Lame per sega



31203-50

Begrenzungsscheibe
Limiting disc
Disco de tope
Disco eccentrico



31203-50
für Sägeblatt mit Ø 65mm
for Saw blade with Ø 65mm
para hoja de sierra Ø 65mm
per lama di sega Ø 65mm

31210-65
31204-01
31204-03
31211-65
31204-02
31204-04
31212-65

Zubehör
Accessories
Accessorio
Accessori



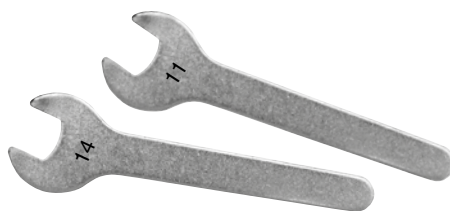
31200-95



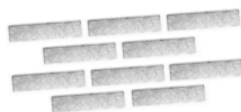
31202-16



31210-30



31212-02, 11 mm
31202-14, 14 mm



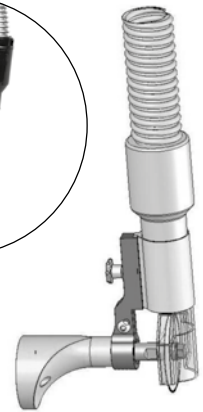
31220-99
10 Stück
10 pieces
10 piezas
10 pezzi



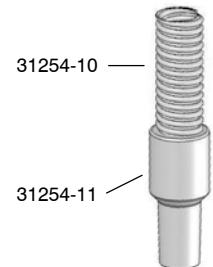
Absauganlage und Wagen ohne Gipsäge
 Hoover and carriage without plaster saw
 Aspirador y careta sin sierra
 Aspirazione e carello senza sega

31252-11 120 Volt, 500 - 1250 Watt (1250 PT), 19 kg

31252-22 230 Volt, 500 - 1200 Watt (1450 PT), 19 kg

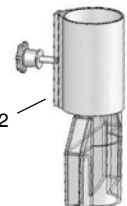


Aufgebaute Einheit
Set-up unit



31254-10

31254-11



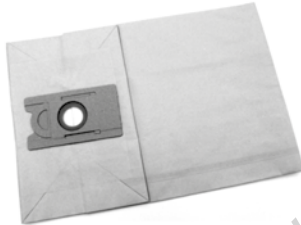
31254-12

31253-00 230 Volt
 31253-11 120 Volt

Zubehör für 31252-22 und 31252-11
Accessories for 31252-22 and 31252-11
Accesorios para 31252-22 y 31252-11
Accessorio per 31252-22 e 31252-11

- 31253-00 230 Volt, Staubsauger, Hoover, aspirador, aspirapolvere
- 31253-11 120 Volt, Staubsauger, Hoover, aspirador, aspirapolvere
- 31254-10 Saugschlauch 3,3 Meter, schwarz, suction hose 3,3 meter, black, manguera de aspiracion 3,3 metros, negra, tubo di aspirazione 3,3 metri, nera
- 31254-11 Saugdüse schwarz, suction nozzle black, boquilla aspirante negra, ugello aspirante nero
- 31254-12 Saughaube kpl., suction cover cpl., cofia de aspiracion cpl., cuffia di aspirazione cpl.
- 31250-10 Set Filtertüten, set filter paper, set de filtros, set di filtros:
1x 31250-15
6x 31250-12
6x 31250-14

31250-12



Staubbeutel, Ather, antera, antera

31250-13



Motorfilter, motor filter, filtro para motor, filtro per motore

31250-14



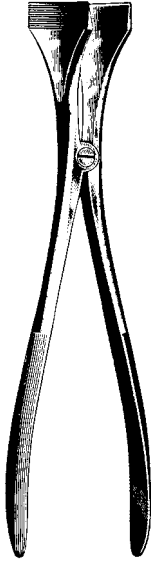
Duftstick, flavor stick, stick de aroma, stick di effluvio

31250-15

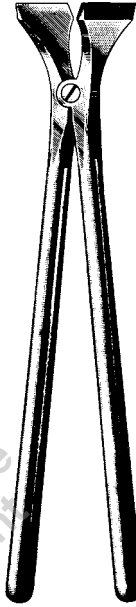


HEPA-Filter, HEPA-Filter, filtro HEPA, filtro HEPA,

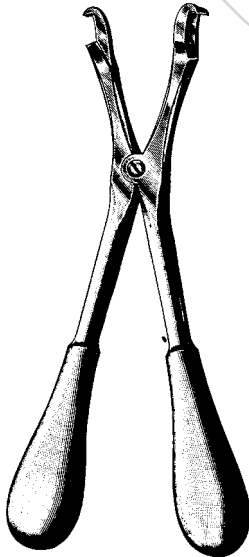
Gipsspreizer
Plaster Cast Instruments
Instrumentos para vendajes enyesados
Allargagessi



HENNIG
31350-28 28 cm, 11"



BEESON
31360-30 30 cm, 11 3/4"



HAGLUND-STILLE
31362-28 28 cm, 11"



HADEO
31366-23 23 cm, 9"

Gipsmesser, Gipsabreißzangen
Plaster Cast Instruments, Knives
Instrumentos para vendajes enyesados, Cuchillos
Allargagessi, Coltelli per Gessi, Strappagessi



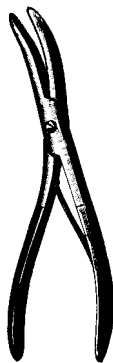
HOPKINS
31370-20
20 cm, 8"



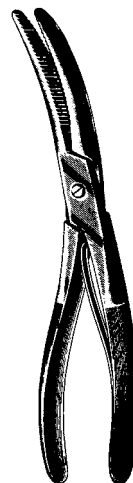
ESMARCH
31380-18
18 cm, 7"



REINER
31390-18
18 cm, 7"

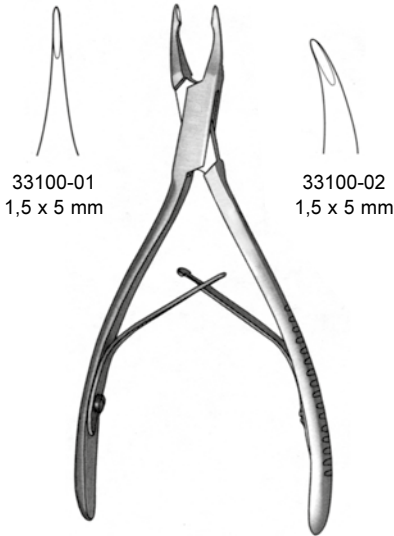


WOLFF
31395-18
18 cm, 7"



WOLFF
31397-24
24 cm, 9 1/2"

Hohlmeißelzangen
Bone Rongeurs
Pinzas-gubias
Pinze sgorbie



33100-01
1,5 x 5 mm

33100-02
1,5 x 5 mm

MICRO FRIEDMAN
14 cm, 5 1/2"



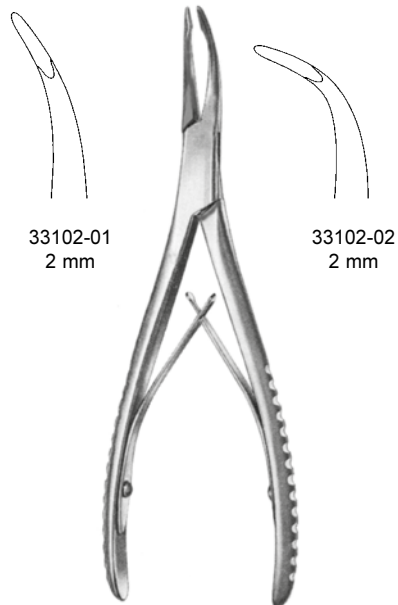
2 mm

FRIEDMAN Mini
33101-12 12 cm, 4 3/4"



3,5 mm

FRIEDMAN
33101-14 14 cm, 5 1/2"



33102-01
2 mm

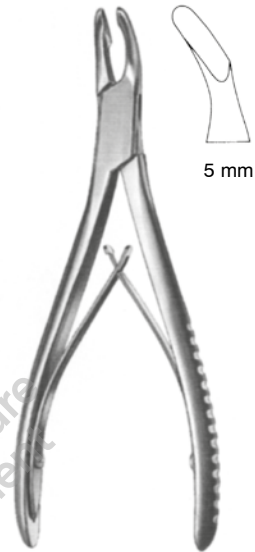
33102-02
2 mm

STELLBRINK
17 cm, 6 3/4"

Hohlmeißelzangen
Bone Rongeurs
Pinzas-gubias
Pinze sgorbie



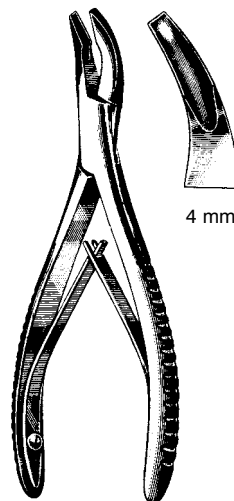
CLEVELAND
33103-14 14 cm, 5 1/2"



CLEVELAND
33105-17 17 cm, 6 3/4"

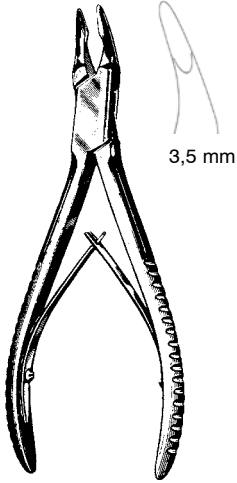


MEAD
33107-16 16,5 cm, 6 1/2"

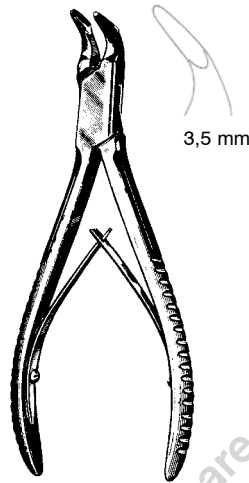


MEAD
33109-16 16,5 cm, 6 1/2"

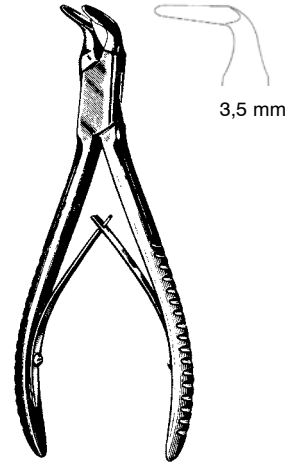
Hohlmeißelzangen
 Bone Rongeurs
 Pinzas-gubias
 Pinze sgorbie



BLUMENTHAL
 33115-15
 15,5 cm, 6"



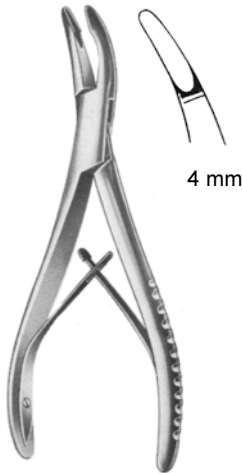
BLUMENTHAL
 33117-15
 15,5 cm, 6"



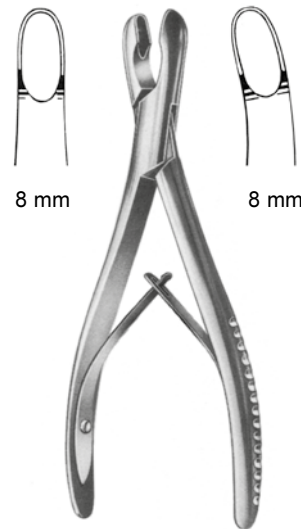
BLUMENTHAL
 33119-15
 15,5 cm, 6"



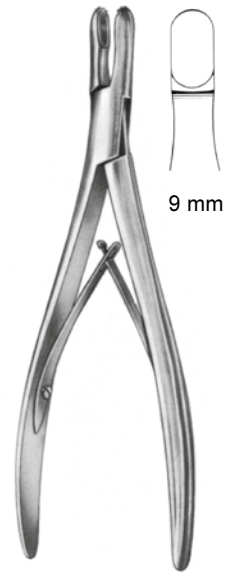
LUER
 33131-15
 15 cm, 5.9"



LUER
 33133-15
 15 cm, 5.9"



LUER
 33136-17 33137-17
 17 cm, 6 3/4"



ADSON
 33142-20 33143-20
 20 cm, 7.9"

Hohlmeißelzangen
Bone Rongeurs
Pinzas-gubias
Pinze sgorbie



OLIVECRONA
33147-20
20 cm, 7.9"



BANE-HARTMANN
33148-18
17,5 cm, 7"



LEMPERT
33150-16 33151-16
16 cm, 6 1/4"



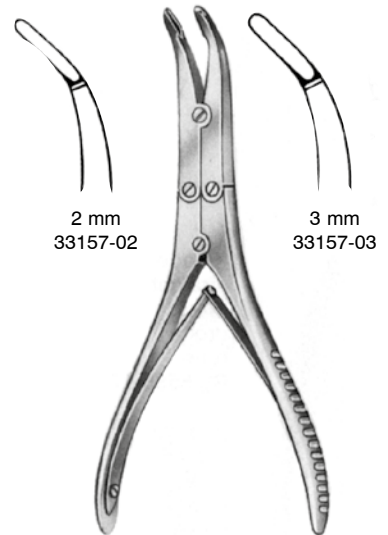
JANSEN
33152-17 33153-17
17 cm, 6 3/4"



LEMPERT
33154-18 33155-18
18,5 cm, 7 1/4"



BEYER
33156-18
18 cm, 7"



KLEINERT-KUTZ
15 cm, 6"

Hohlmeißelzangen
Bone Rongeurs
Pinzas-gubias
Pinze sgorbie



3 mm
33157-04



4 mm
33157-05



5 mm
33157-06



3 mm
33158-03



4 mm
33158-04



5 mm
33158-05



3 mm
33159-03



4 mm
33159-04



5 mm
33159-05



SMITH-PETERSEN
24 cm, 9 1/2"



BEYER
33201-18
18 cm, 7"



3 mm



MAYFIELD
33202-18
18 cm, 7"



3 mm



ZAUFAL-JANSEN
33205-18
18 cm, 7"



4 mm

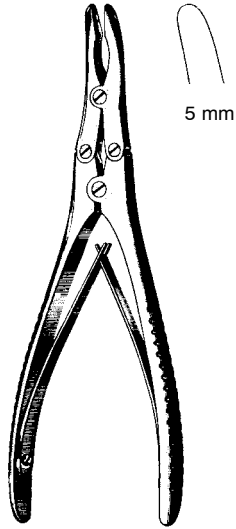


BÖHLER
33211-15 33213-15
15 cm, 6"

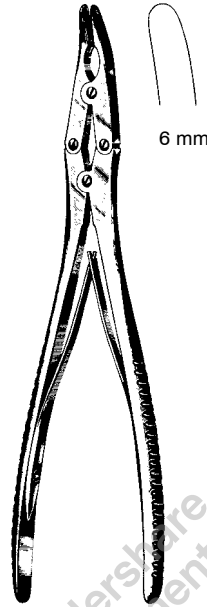
3 mm



Hohlmeißelzangen
Bone Rongeurs
Pinzas-gubias
Pinze sgorbie



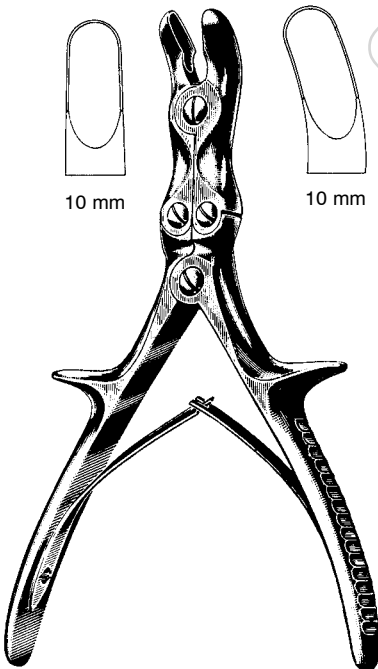
— RUSKIN —
33216-18 33217-18
18 cm, 7"



RUSKIN
33219-23 23 cm, 9"



MARQUARDT
33220-20 20 cm, 8"



— STILLE-LUER —
33230-22 22 cm, 8 3/4" 33231-22
33230-26 26 cm, 10 1/4" 33231-26

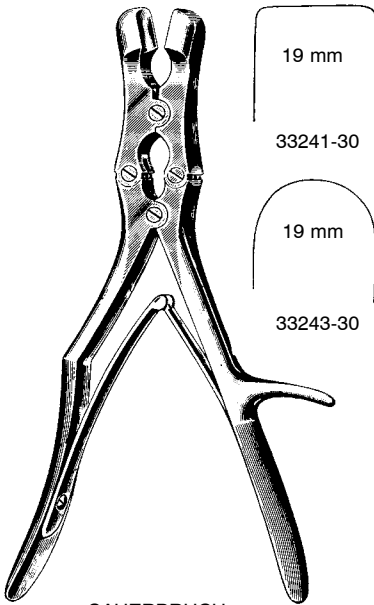


STILLE-LUER
33235-23
23 cm, 9"

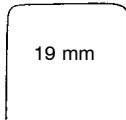


STILLE-RUSKIN
33237-23
23 cm, 9"

Hohlmeißelzangen
 Bone Rongeurs
 Pinzas-gubias
 Pinze sgorbie

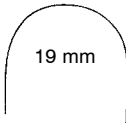


SAUERBRUCH
 30 cm, 10 3/4"



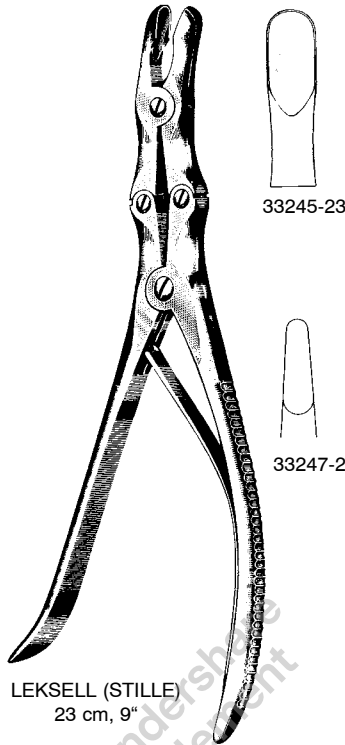
19 mm

33241-30

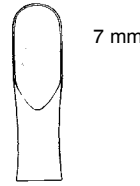


19 mm

33243-30

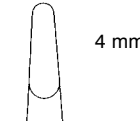


LEKSELL (STILLE)
 23 cm, 9"



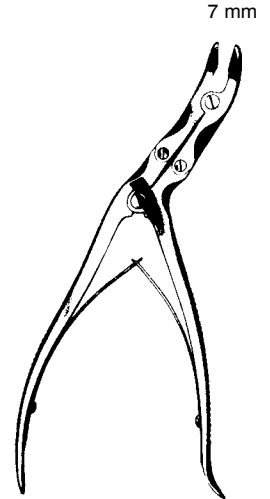
7 mm

33245-23



4 mm

33247-23



SCAGLIETTI
 26 cm, 10 1/4"

33251-26
 rechts
 right
 derecha
 a destra

33253-26
 links
 left
 izquierda
 a sinistra



ECHLIN
 33257-23 2 mm
 33258-23 4 mm
 33259-23 3 mm
 23 cm, 9"



FRYKHOLM
 33260-24
 24 cm, 9 1/2"

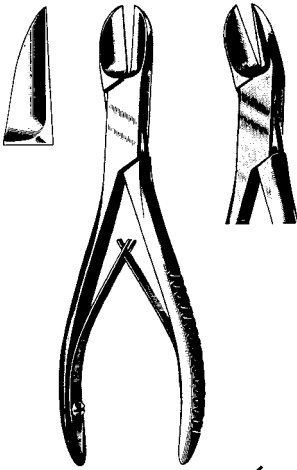
4,5 mm



SEMB
 33261-22
 22,5 cm, 8.9"

17 mm

Knochensplitterzangen
Bone Cutting Forceps
Pinzas cortantes para huesos
Cesoie per ossa



LISTON

33274-14	14 cm, 5 1/2"	33275-14
33274-17	17 cm, 6 3/4"	33275-17
33274-19	19 cm, 7 1/2"	33275-19
33274-22	22 cm, 8 3/4"	33275-22



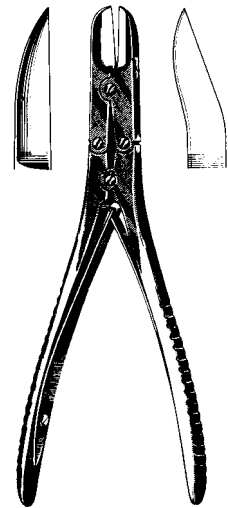
BÖHLER

33280-15	33281-15
15 cm, 6"	



COTTLE-KAZANJIAN

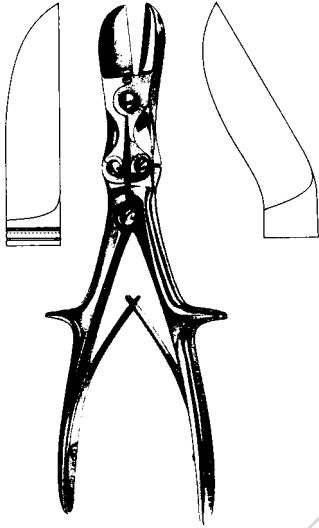
33282-19
19 cm, 7 1/2"

MC INDOE
33283-17
17 cm, 6 3/4"STAMM
33284-15
15 cm, 6"

RUSKIN-LISTON

33286-18	33289-18
18 cm, 7"	

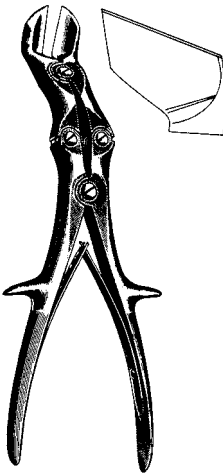
Knochensplitterzangen
Bone Cutting Forceps
Pinzas cortantes para huesos
Cesoie per ossa



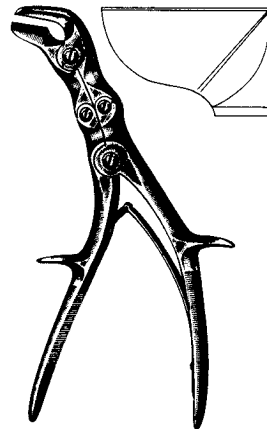
— STILLE-LISTON —
33290-23 23 cm, 9" 33291-23
33290-27 27 cm, 10 1/2" 33291-27



STILLE-LISTON
33292-26
26 cm, 10 1/4"

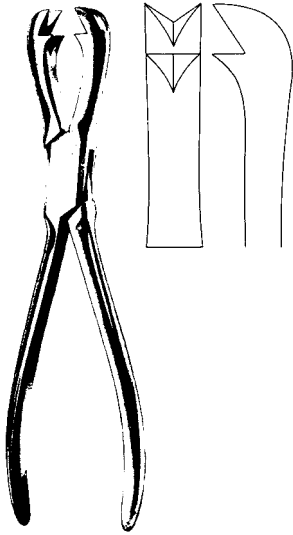


STILLE-HORSLEY
33293-27
27 cm, 10 1/2"

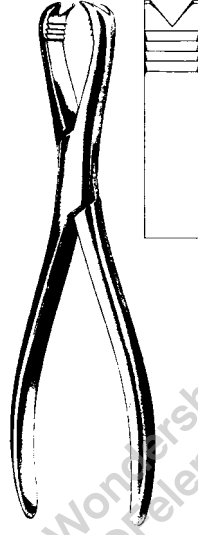


SEMB
33295-24
24 cm, 9 1/2"

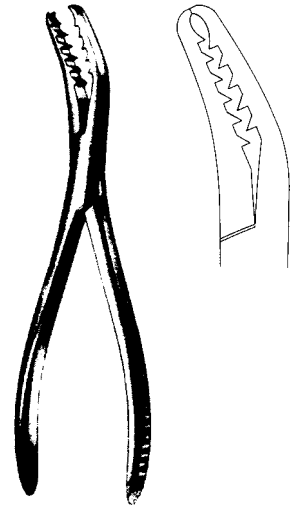
Knochenhaltezzangen
Bone Holding Forceps
Pinzas para huesos
Tenaglie per ossa



FERGUSSON
33360-21
21 cm, 8 1/4"



LANGENBECK
33362-21
21 cm, 8 1/4"



SEMB
33365-19
19 cm, 7 1/2"



SEMB
33366-19
20 cm, 8"



FARABEU
33366-23 23 cm, 9"
33366-26 26 cm, 10 1/4"



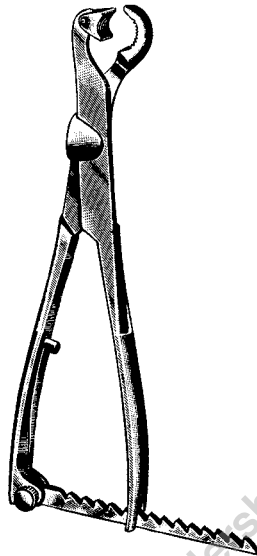
FARABEU-F-LAMBOTTE
33368-26
26 cm, 10 1/4"

Knochenhalte­zangen
Bone Holding Forceps
Pinzas para huesos
Tenaglie per ossa



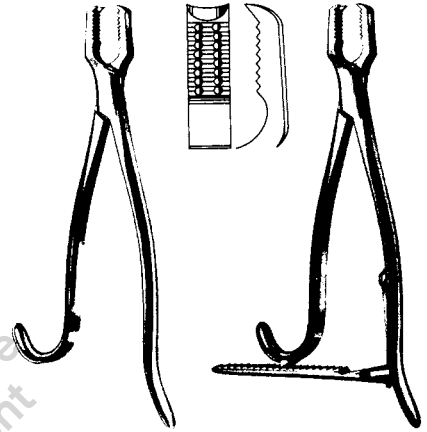
LAMBOTTE

33370-22 22 cm, 8 3/4"
33370-27 27 cm, 10 1/2"
33370-30 30 cm, 11 3/4"



LAMBOTTE

33372-22 22 cm, 8 3/4"
33372-26 26 cm, 10 1/4"
33372-33 33 cm, 13"



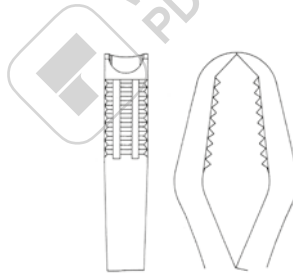
KERN

33378-15 15 cm, 6" 33380-15
33378-17 17 cm, 6 3/4" 33380-17
33378-21 21 cm, 8 1/4" 33380-21



LANE

33382-33 33 cm, 13"
33382-45 45 cm, 17 3/4"



LANE

33384-33 33 cm, 13"
33384-45 45 cm, 17 3/4"

Knochenhaltezangen
 Bone Holding Forceps
 Pinzas para huesos
 Tenaglie per ossa

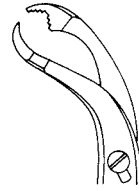
selbstzentrierend
 self-centering
 autocentrantes
 autocentranti

2,5 mm

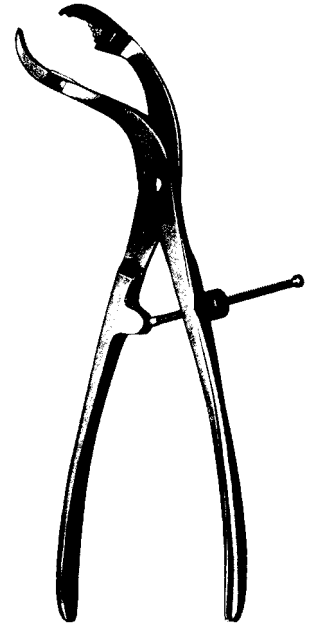


33391-15
 15 cm, 6"

6,5 mm

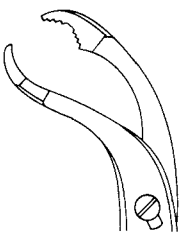


33391-19
 19 cm, 7 1/2"



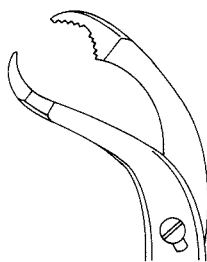
33391-15 - 33391-28

9,5 mm



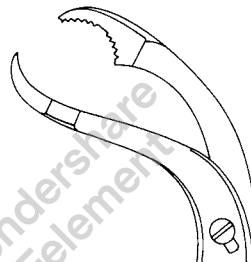
33391-24
 24 cm, 9 1/2"

10 mm

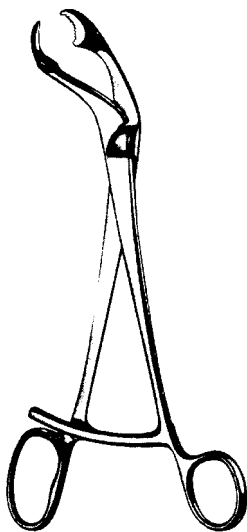


33391-26
 26 cm, 10 1/4"

11 mm

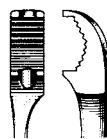


33391-28
 28 cm, 11"



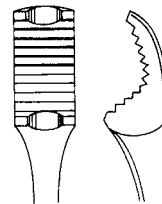
VERBRUGGE
 33395-17 - 33395-27

5 mm



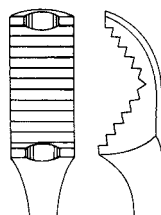
33395-17
 17,5 cm, 7"

9,5 mm



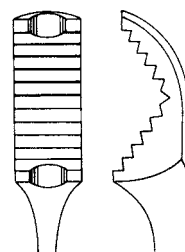
33395-25
 25 cm, 10"

10,5 mm



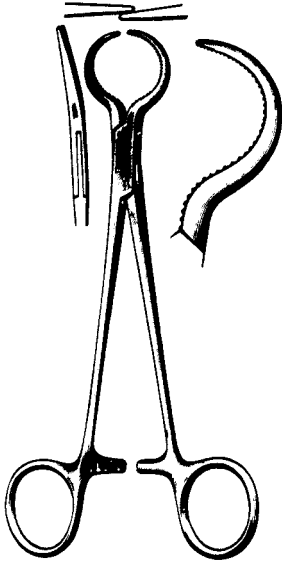
33395-26
 26 cm, 10 1/4"

12 mm

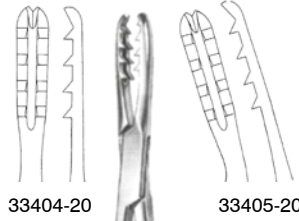


33395-27
 27 cm, 10 1/2"

Knochenhalte­zangen
Bone Holding Forceps
Pinzas para huesos
Tenaglie per ossa



LEWIN
33402-17
17,5 cm, 7"



33404-20

33405-20



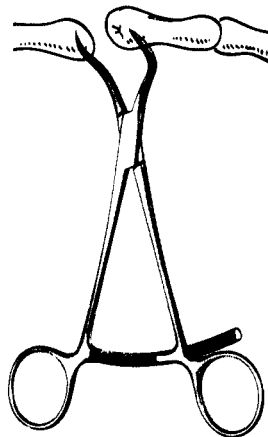
BIRCHER-GANSKE
20 cm, 8"



33406-20
20 cm, 8"



DINGMANN
33407-19
19 cm, 7 1/2"



HADEO
33409-13
13,5 cm, 5 1/4"

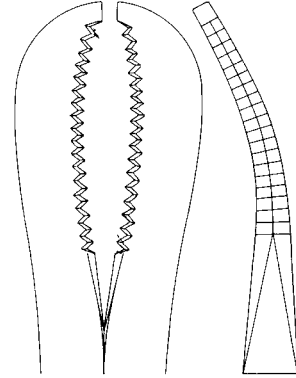


MARTIN
33410-19
19 cm, 7 1/2"

Knochenhaltezangen
Bone Holding Forceps
Pinzas para huesos
Tenaglie per ossa

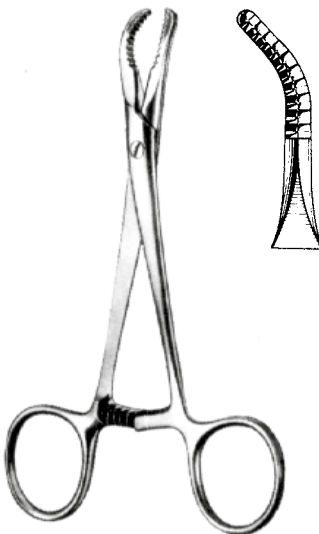


33412-16
16 cm, 6 1/4"



33412-24
24 cm, 9 1/2"

HADEO
33412-16 - 33412-24

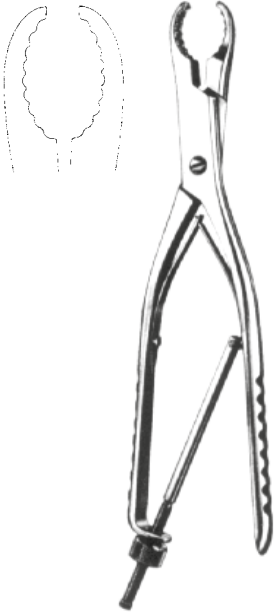


HADEO
33413-14
13,5 cm, 5 1/4"

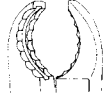


33414-21
21 cm, 8 1/4"

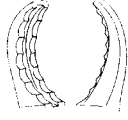
Knochenhaltezangen
Bone Holding Forceps
Pinzas para huesos
Tenaglie per ossa



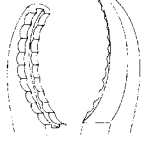
ULRICH
33415-23 - 33415-28



33415-23
23 cm, 9"



33415-25
25 cm, 10"



33415-28
28 cm, 11"



REILL
33416-17 17 cm, 6 3/4"



PATELLA
33417-18 18,5 cm, 7 1/4"



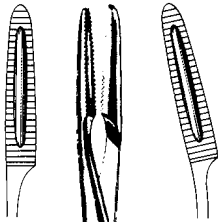
MEYER
33418-17 17 cm, 6 3/4"



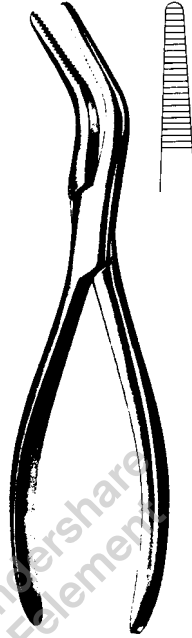
MEYER
33419-20 20,5 cm, 8"

Wondershare PDFelement

Knochenhaltezaugen, -Klammern
 Bone holding forceps, -Clamps
 Pinzas para huesos, Clamps porta-huesos
 Tenaglie per ossa, Pinze per ossa



33420-20 33421-20
 20 cm, 8"



VAN BUREN
 33423-23
 23 cm, 9"



FELDHEIM
 33424-10
 10 cm, 4"



LOWMAN
 33441-13 13 cm, 5 1/8"
 33441-18 18 cm, 7"
 33441-20 20 cm, 8"

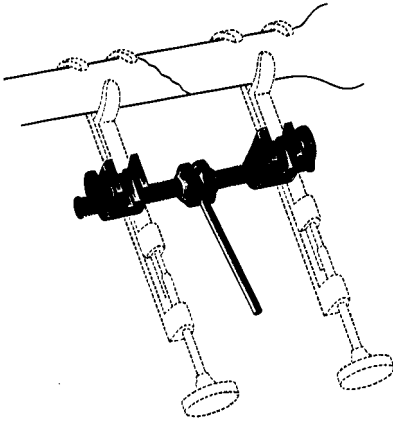


LOWMAN-HOGLUND
 33442-19
 19 cm, 7 1/2"



LAMBERT-LOWMAN
 33443-18
 18 cm, 7"

Knochenhalte­zangen, Bleihand
 Bone holding forceps, Lead Hands
 Pinzas para huesos, Manoplas de plomo
 Tenaglie per ossa, Mani di piombo



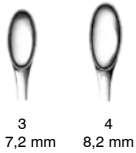
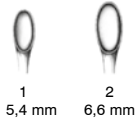
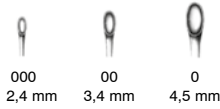
GERSTER
33444-15



33450-01
 32 cm, 12 3/4"
 Erwachsen
 adult size
 p. adultos
 p. adulti

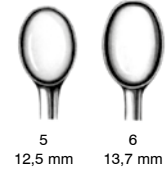
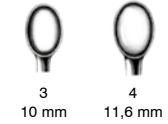
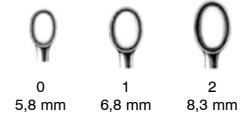
33450-02
 24 cm, 9 1/2"
 Kind
 child size
 p. niños
 p. bambini

Scharfe Löffel
Bone Curettes
Cucharillas cortantes
Curette taglianti

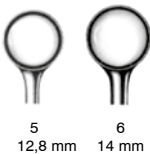
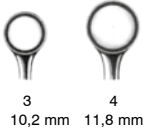
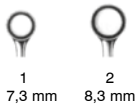


SCHEDE	Fig.	VOLKMANN
	0000	33469-96
33467-97	000	33469-97
33467-98	00	33469-98
33468-00	0	33470-00
33468-01	1	33470-01
33468-02	2	33470-02
33468-03	3	33470-03
33468-04	4	33470-04
	5	33470-05
	6	33470-06

SCHEDE
17 cm, 6 3/4"
33467-97 - 33468-04

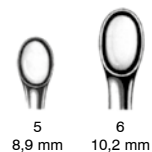
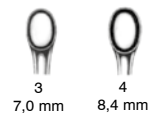
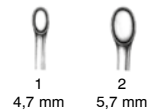
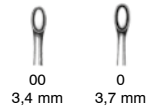
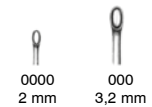


VOLKMANN
17 cm, 6 3/4"
33469-96 - 33470-06



BRUNS	Fig.	SPRATT
33471-96	0000	33474-96
33471-97	000	33474-97
33471-98	00	33474-98
33472-00	0	33475-00
33472-01	1	33475-01
33472-02	2	33475-02
33472-03	3	33475-03
33472-04	4	33475-04
33472-05	5	33475-05
33472-06	6	33475-06

BRUNS
17 cm, 6 3/4"
33471-96 - 33472-06



SPRATT
17 cm, 6 3/4"
33474-97 - 33475-06

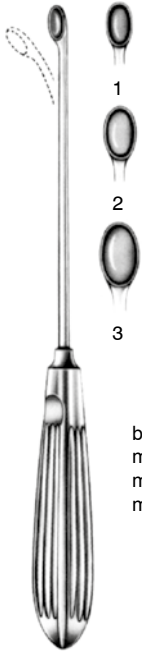
Scharfe Löffel
Bone Currettes
Cucharillas cortantes
Curette taglianti



Fig.		
1	33473-01	3,5 mm
2	33473-02	4,5 mm
3	33473-03	5,5 mm
4	33473-04	7,5 mm
5	33473-05	8,5 mm
6	33473-06	10,0 mm

COBB
27,9 cm 11"

Scharfe Löffel
Bone Curettes
Cucharillas cortantes
Curette taglienti



- Fig.
1 33476-01 4,8 mm
2 33476-02 5,8 mm
3 33476-03 6,8 mm

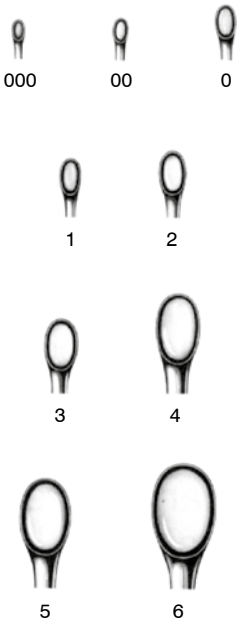
biegsam
malleable
maleable
malleabile

HALLÉ
21 cm, 8 1/4"
33476-01 - 33476-02



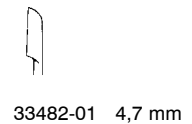
- Fig.
000 33476-98 2,8 mm
00 33476-99 3,3 mm
0 33477-00 3,7 mm
1 33477-01 4,3 mm
2 33477-02 4,8 mm
3 33477-03 5,6 mm
4 33477-04 6,1 mm
5 33477-05 6,7 mm
6 33477-06 8,8 mm

SPINAL
20 cm, 8"
33476-98 - 33477-06



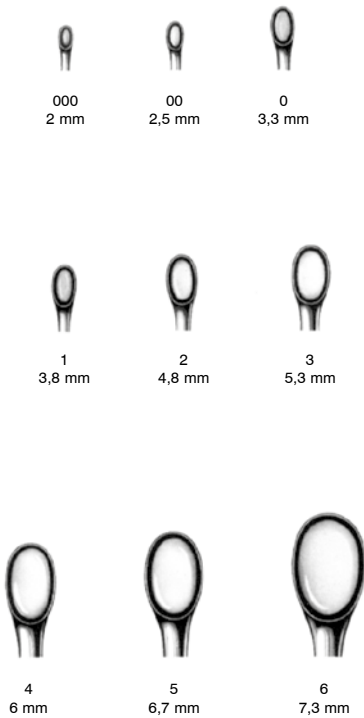
- Fig.
000 33478-98 2,8 mm
00 33478-99 3,3 mm
0 33479-00 3,7 mm
1 33479-01 4,3 mm
2 33479-02 4,8 mm
3 33479-03 5,6 mm
4 33479-04 6,1 mm
5 33479-05 6,7 mm
6 33479-06 8,8 mm

SPINAL
20 cm, 8"
33478-98 - 33479-06



SCOVILLE
25 cm, 10"
33482-01 - 33482-03

Scharfe Löffel
Bone Currettes
Cucharillas cortantes
Curette taglianti



BRUNS
23 cm, 9"



BRUNS
23 cm, 9"



BRUNS
23 cm, 9"

Fig.
000
00
0
1
2
3
4
5
6

33480-97
33480-98
33481-00
33481-01
33481-02
33481-03
33481-04
33481-05
33481-06

33482-97 2,8 mm
33482-98 3,3 mm
33483-00 3,7 mm
33483-01 4,3 mm
33483-02 4,8 mm
33483-03 5,6 mm
33483-04 6,1 mm
33483-05 6,7 mm
33483-06 8,8 mm

33484-97 2,8 mm
33484-98 3,3 mm
33485-00 3,7 mm
33485-01 4,3 mm
33485-02 4,8 mm
33485-03 5,6 mm
33485-04 6,1 mm
33485-05 6,7 mm
33485-06 8,8 mm

Scharfe Löffel
Bone Currettes
Cucharillas cortantes
Curette taglianti



33485-21 21 cm, 8 1/4"
oval/rund
ovale/ronde
ovalado/redondo
ovale/rotonda



WILLIGER
17,5 cm
7"

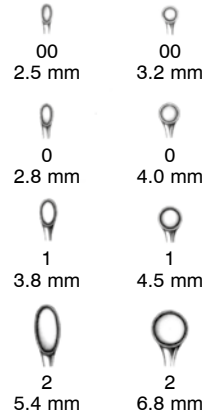


Fig. 00	33485-99	33486-99
0	33486-00	33487-00
1	33486-01	33487-01
2	33486-02	33487-02



DAUBENSPECK
20 cm, 8"



Fig. 00	33487-99
0	33488-00
1	33488-01
2	33488-02



27 cm
10 1/2"



Fig. 0	33489-00
1	33489-01
2	33489-02
3	33489-03

Scharfe Löffel
 Bone Currettes
 Cucharillas cortantes
 Curette taglianti



LEMPERT
 17,5 cm, 7"



0



00



000



0000

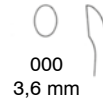


00000

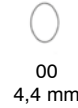
Fig. 0	33490-10	3,3 mm
00	33490-20	3,0 mm
000	33490-30	2,7 mm
0000	33490-40	2,4 mm
00000	33490-50	2,0 mm



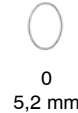
HADEO
 25 cm, 10"



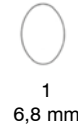
000
 3,6 mm



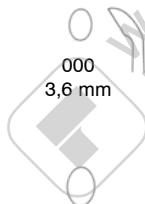
00
 4,4 mm



0
 5,2 mm



1
 6,8 mm



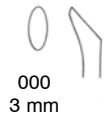
000
 3,6 mm

00
 4,4 mm

0
 5,2 mm

1
 6,8 mm

Fig. 000	33491-01
00	33491-02
0	33491-03
1	33491-04



000
 3 mm

00
 4 mm

0
 5 mm

Fig. 000	33491-05
00	33491-06
0	33491-07
1	33491-08

Fig. 000	33500-01
00	33500-02
0	33500-03



HADEO
 25 cm, 10"



BUSHE
 25 cm, 10"

Scharfe Löffel
Bone Curettes
Cucharillas cortantes
Curette taglianti



33492-13 6.8 mm
33492-16 9.0 mm
33492-20 11.1 mm

33492-13 6.3 mm
33492-16 7.0 mm
33492-20 9.1 mm

VOLKMANN

33492-13 13 cm, 5 1/8"
33492-16 16 cm, 6 1/4"
33492-20 20 cm, 8"



33494-13 7.5 mm
33494-14 6.8 mm
33494-17 6.8 mm

33494-13 6.3 mm
33494-14 6.2 mm
33494-17 7.3 mm

VOLKMANN

33494-13 13 cm, 5 1/8"
33494-14 14 cm, 5 1/2"
33494-17 17 cm, 6 3/4"

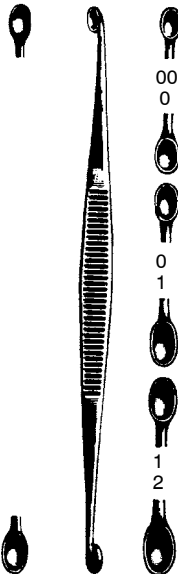


5.2 mm

3.5 mm

JANSEN

33495-16
16 cm, 6 1/4"



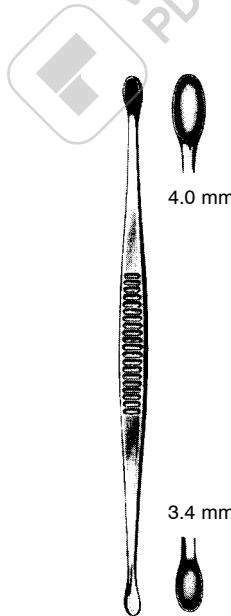
00 2.5 mm
0 3.0 mm

0 3.0 mm
1 3.5 mm

1 3.5 mm
2 4.0 mm

WILLIGER

13,5 cm, 5 1/4" Fig.
33496-00 00/0
33496-01 0/1
33496-12 1/2

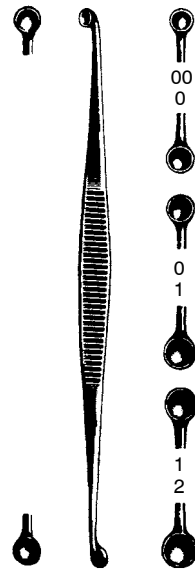


4.0 mm

3.4 mm

JACOBSON

13 cm, 5 1/8"
33497-00



00 2.5 mm
0 3.1 mm

0 3.1 mm
1 3.5 mm

1 3.5 mm
2 4.0 mm

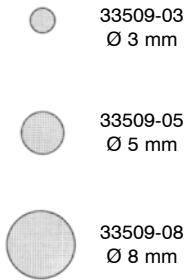
MARTINI

13,5 cm, 5 1/4"
33498-00
33498-01
33498-12

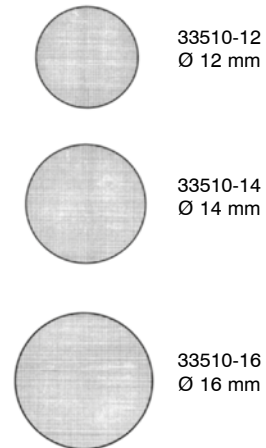
Stößel
Hemostats
Hemostáticos
Pistoni



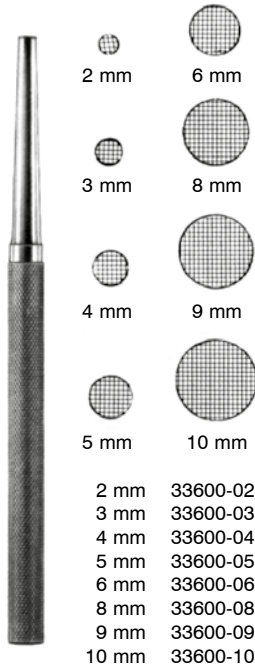
CASPAR
200 mm, 8"



200 mm, 8"



Stößel, Flachmeißel, Hohlmeißel, Osteotome
Hemostats, Chisels, Gouges, Osteotome
Hemostáticos, Cinceles, Gubias, Osteótomo
Pistoni, scalpelli, sgorbie, Osteotomia



16 cm, 6 1/4"

2 mm	33600-02
3 mm	33600-03
4 mm	33600-04
5 mm	33600-05
6 mm	33600-06
8 mm	33600-08
9 mm	33600-09
10 mm	33600-10



13,5 cm, 5 1/4"

4 mm	33602-04
6 mm	33602-06
8 mm	33602-08
10 mm	33602-10
12 mm	33602-12
14 mm	33602-14
16 mm	33602-16



13,5 cm, 5 1/4"

33604-04	
33604-06	
33604-08	
33604-10	
33604-12	
33604-14	
33604-16	



13,5 cm, 5 1/4"

33605-04	
33605-06	
33605-08	
33605-10	
33605-12	
33605-14	
33605-16	



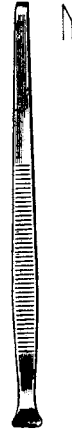
ALEXANDER
17 cm, 6 3/4"

33610-04	4 mm
33610-06	6 mm
33610-08	8 mm
33610-10	10 mm
33610-12	12 mm
33610-14	14 mm



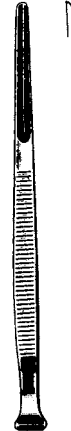
ALEXANDER
17 cm, 6 3/4"

33611-04	4 mm
33611-06	6 mm
33611-08	8 mm
33611-10	10 mm
33611-12	12 mm
33611-14	14 mm



PARTSCH
13,5 cm, 5 1/4" mm 17 cm, 6 3/4"

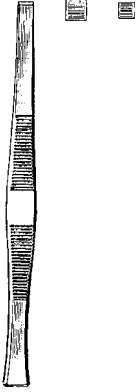
33620-02	2	33622-02
33620-03	3	33622-03
33620-04	4	33622-04
33620-05	5	33622-05
33620-06	6	33622-06
33620-07	7	33622-07
33620-08	8	33622-08



PARTSCH
13,5 cm, 5 1/4" mm 17 cm, 6 3/4"

33623-02	2	33625-02
33623-03	3	33625-03
33623-04	4	33625-04
33623-05	5	33625-05
33623-06	6	33625-06
33623-07	7	33625-07
33623-08	8	33625-08

Flachmeißel, Hohlmeißel, Osteotome
 Chisels, Gouges, Osteotome
 Cinceles, Gubias, Osteótomo
 Scalpelli, sgorbie, Osteotomia



PASSOW
 12 cm, 4 3/4"
 33626-35 3,5 mm
 33626-25 2,5 mm



BRÜNINGS-LUCAS
 16 cm, 6 1/4"
 33627-04 4 mm
 33627-06 6 mm



BRÜNINGS-LUCAS
 16 cm, 6 1/4"
 33628-03 3 mm
 33628-05 5 mm



STILLE
 20 cm, 8"

- 33630-06 6 mm
- 33630-08 8 mm
- 33630-10 10 mm
- 33630-12 12 mm
- 33630-15 15 mm
- 33630-20 20 mm
- 33630-25 25 mm
- 33630-30 30 mm



STILLE
 20 cm, 8"

- 33631-10 6 mm
- 33631-12 8 mm
- 33631-15 10 mm
- 33631-20 12 mm
- 33631-25 15 mm
- 33631-30 20 mm



STILLE
 20 cm, 8"

- 33632-06 6 mm
- 33632-08 8 mm
- 33632-10 10 mm
- 33632-12 12 mm
- 33632-15 15 mm
- 33632-20 20 mm
- 33632-25 25 mm
- 33632-30 30 mm



STILLE
 20 cm, 8"

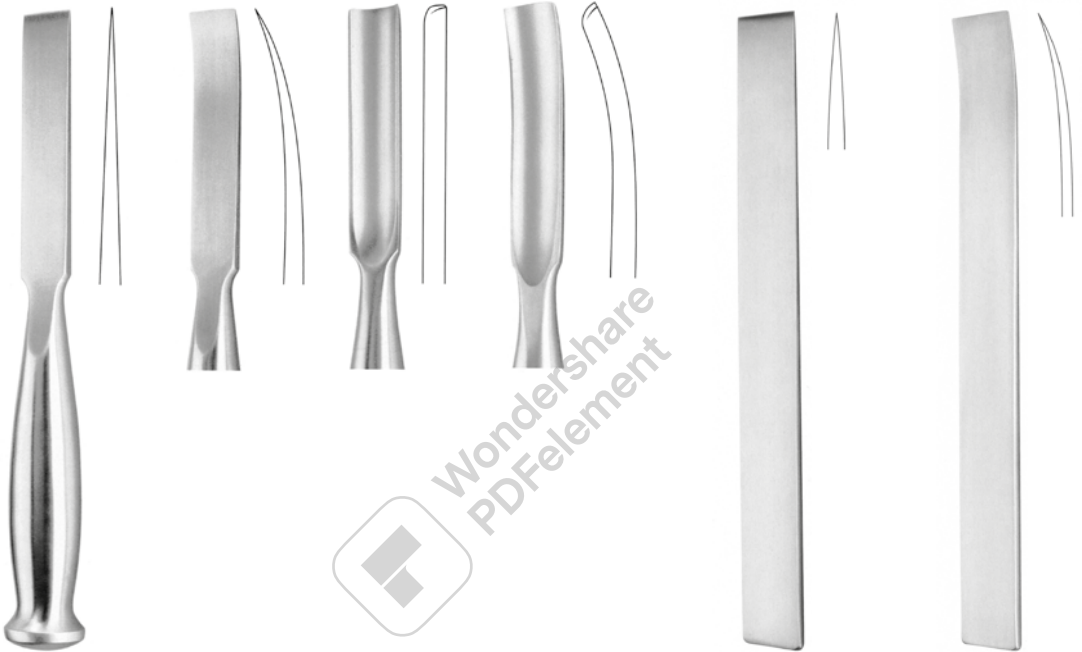
- 33633-06 6 mm
- 33633-08 8 mm
- 33633-10 10 mm
- 33633-12 12 mm
- 33633-15 15 mm
- 33633-20 20 mm
- 33633-25 25 mm
- 33633-30 30 mm



STILLE
 20 cm, 8"

- 33634-06 6 mm
- 33634-08 8 mm
- 33634-10 10 mm
- 33634-12 12 mm
- 33634-15 15 mm
- 33634-20 20 mm
- 33634-25 25 mm
- 33634-30 30 mm

Osteotome, Hohlmeißel
Osteotome, Gouges
Osteótomo, Gubias
Osteotomia, sgorbie



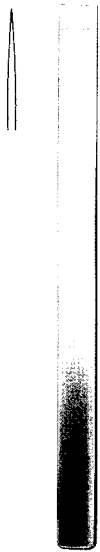
SMITH-PETERSEN
20 cm, 8"

6 mm	33644-06	33645-06	33647-06	
9 mm	33644-09	33645-09	33647-09	33649-09
13 mm	33644-13	33645-13		
14 mm			33647-14	33649-14
16 mm	33644-16	33645-16	33647-16	33649-16
19 mm	33644-19	33645-19	33647-19	33649-19
25 mm	33644-25	33645-25	33647-25	33649-25
32 mm	33644-32	33645-32	33647-32	33649-32

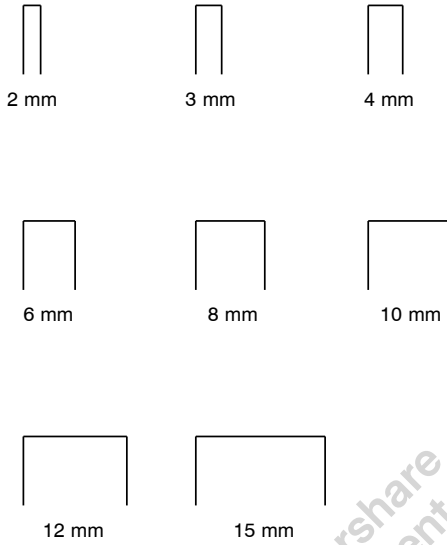
LAMBOTTE
24 cm, 9 1/2" 23 cm, 9"

33650-04	4 mm	33651-04
33650-06	6 mm	33651-06
33650-08	8 mm	33651-08
33650-10	10 mm	33651-10
33650-13	13 mm	33651-13
33650-16	16 mm	33651-16
33650-18	18 mm	33651-18
33650-20	20 mm	33651-20
33650-25	25 mm	33651-25
33650-30	30 mm	33651-30
33650-38	38 mm	33651-38
33650-44	44 mm	33651-44
33650-50	50 mm	33651-50

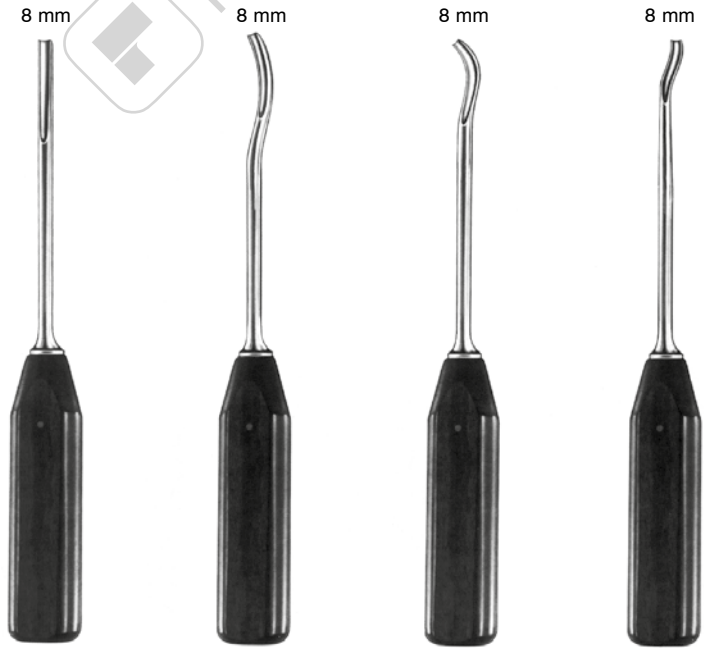
Osteotome, Hohlmeißel
 Osteotome, Chisels, Gouges
 Osteótomo, Cinceles, Gubias
 Osteotomia, Scalpelli, sgorbie



MINI-LAMBOTTE



12,5 cm, 5"	mm	17 cm, 6 3/4"
33654-02	2	33652-02
33654-03	3	33652-03
33654-04	4	33652-04
33654-06	6	33652-06
33654-08	8	33652-08
33654-10	10	33652-10
33654-12	12	33652-12
33654-15	15	33652-15



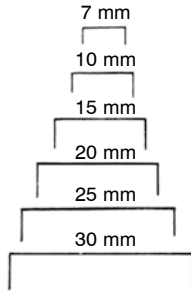
mit Ferrozellgriff
 with Ferrozell-Handle
 con mango de Ferrozell
 con manico di Ferrozell

COBB	COBB	COBB	COBB
28 cm, 11"	28 cm, 11"	28 cm, 11"	28 cm, 11"
33656-28	33657-28	33658-28	33659-28

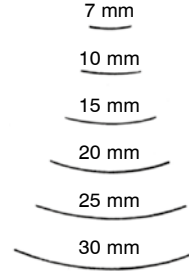
Osteotome und Hohlmeißel mit Ferrozell-Griff
 Osteotome and Gouges with Ferrozell-Handle
 Osteótomo, Gubias con mango de Ferrozell
 Osteotomo, con manico di Ferrozell



LEXER
22 cm, 8 3/4"



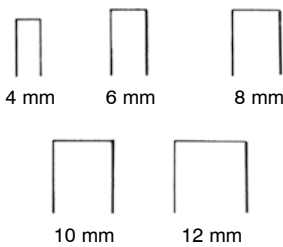
33660-07	7 mm	33661-07
33660-10	10 mm	33661-10
33660-15	15 mm	33661-15
33660-20	20 mm	33661-20
33660-25	25 mm	33661-25
33660-30	30 mm	33661-30



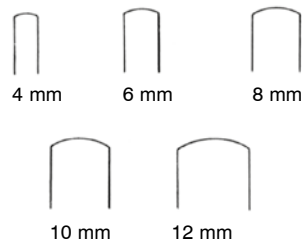
LEXER
22 cm, 8 3/4"



LEXER MINI
18 cm, 7"



33664-04	4 mm	33665-04
33664-06	6 mm	33665-06
33664-08	8 mm	33665-08
33664-10	10 mm	33665-10
33664-12	12 mm	33665-12



LEXER MINI
18 cm, 7"

Flachmeißel, Hohlmeißel
Chisels, Gouges
Cinceles, Gubias
Scalpelli, sgorbie

mit Ferrozellgriff
with Ferrozell-Handle
con mango de Ferrozell



20 mm

33665-24
24,5 cm, 9 3/4"



16 mm

33665-26
26,5 cm, 10 1/2"

mit NOVOTEX-Griff
with Novotex-Handle
con mango di Novotex

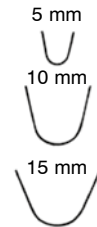


ZIELKE 23 cm, 9"
33665-55 5,5 mm
33665-90 9,0 mm



9 mm

22 cm, 8 3/4"
33666-22



25 cm, 10"

33669-05	5 mm	33670-05
33669-10	10 mm	33670-10
33669-15	15 mm	33670-15

Osteotome, Flachmeißel, Hohlmeißel
 Osteotome, Chisels, Gouges
 Osteótomo, Cinceles, Gubias
 Osteotomia, Scalpelli, Sgorbie



HOKE

14 cm, 5 1/2"

33668-03	3 mm
33668-05	5 mm
33668-06	6 mm
33668-08	8 mm
33668-09	9 mm
33668-13	13 mm
33668-16	16 mm
33668-19	19 mm



HIBBS

24 cm, 9 1/2"

33670-06	6 mm
33670-09	9 mm
33670-13	13 mm
33670-16	16 mm
33670-19	19 mm
33670-25	25 mm
33670-32	32 mm



HIBBS

24 cm, 9 1/2"

33671-06	6 mm
33671-09	9 mm
33671-13	13 mm
33671-16	16 mm
33671-19	19 mm
33671-25	25 mm
33671-32	32 mm



HIBBS

24 cm, 9 1/2"

33672-06	6 mm
33672-09	9 mm
33672-13	13 mm
33672-16	16 mm
33672-19	19 mm
33672-25	25 mm
33672-32	32 mm



HIBBS

24 cm, 9 1/2"

33673-06	6 mm
33673-09	9 mm
33673-13	13 mm
33673-16	16 mm
33673-19	19 mm
33673-25	25 mm
33673-32	32 mm

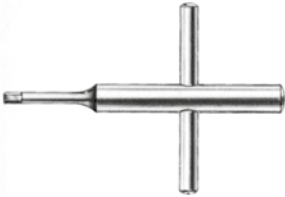


HIBBS

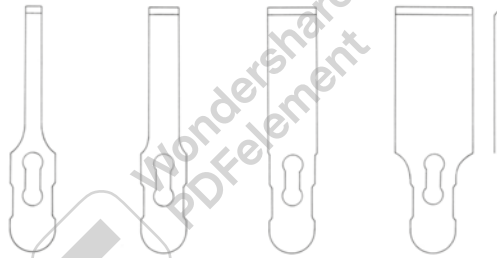
24 cm, 9 1/2"

33675-06	6 mm
33675-09	9 mm
33675-13	13 mm
33675-16	16 mm
33675-19	19 mm
33675-25	25 mm
33675-32	32 mm

Meißel
Chisels
Cinceles
Scalpelli



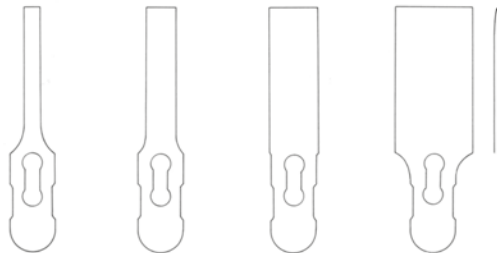
33676-02
9 cm, 3 1/2"
Spannschlüssel
Key
Llave
Clé
Chiave



5 mm 10 mm 16 mm 25 mm
33676-05 33676-10 33676-16 33676-25
8,5 mm, 3.4" 8,5 mm, 3.4" 8,5 mm, 3.4" 8,5 mm, 3.4"

Meißelklingen
auswechselbar
Chisel blades
interchangeable
Hojas de cincel
intercambiables
Lame intercambiabili

33676-01
18,5 cm, 7 1/4"
Griff allein
Handle only
Mango suelto
Manico solo



5 mm 10 mm 16 mm 25 mm
33677-05 33677-10 33677-16 33677-25
8,5 mm, 3.4" 8,5 mm, 3.4" 8,5 mm, 3.4" 8,5 mm, 3.4"

Osteotomklingen
auswechselbar
Osteotome blades
interchangeable
Hojas de osteótomo
intercambiables
Lame per osteotomia
intercambiabili

Sternummeißel, Osteotom, Schädelspalter, Rachiotom, Muskelhaken
 Sternum Chisel, Osteotome, Skull breaker, Rachiotome, Muscle hooks
 Cinceles de esternón, Osteotomo, Cincel rompe-cráneo, Raquiótomos, Ganchos musculare
 Scalpello per sterno, Osteotomo, Divisore per cranio, Rachiotomi, Uncino per muscoli

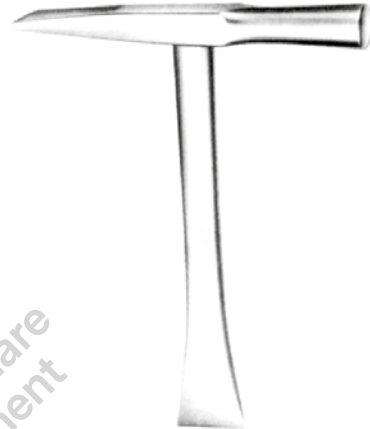
23 mm



LEBSCHE
 33678-24
 24,5 cm, 9 3/4"



33679-13
 13 cm, 5 1/8"



33680-22
 14 cm, 5 1/2"



33682-22
 22 cm, 8 3/4"



19902-10
 10 cm, 4"



19903-00

Medizinlöffel, Meißel, Sektionsnadeln
 Medicine Spoon, Chisels, Post mortem needles
 Cuchara graduada, Cinceles, Agujas para autopsia
 Cucchiario per medicinali, Scalpelli, Aghi per autopsia

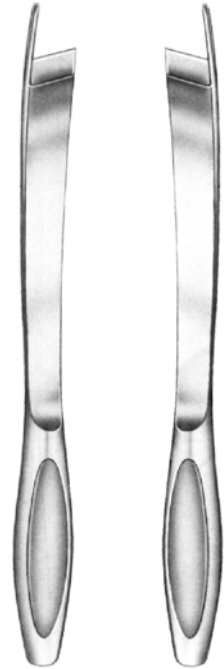


89146-20 20 cc
 110 x 20 mm



63174-00
 Blutschöpfer, 150 ccm
 Blood scoop, 9 cu. inches
 Cucharra p / sangue
 Cucchiario per sangue

Ø 90 mm



BRUNETTI
 28,5 cm, 11 1/4"

33682-01	33682-02
links	rechts
left	right
izquierdo	derecho
sinistra	destra

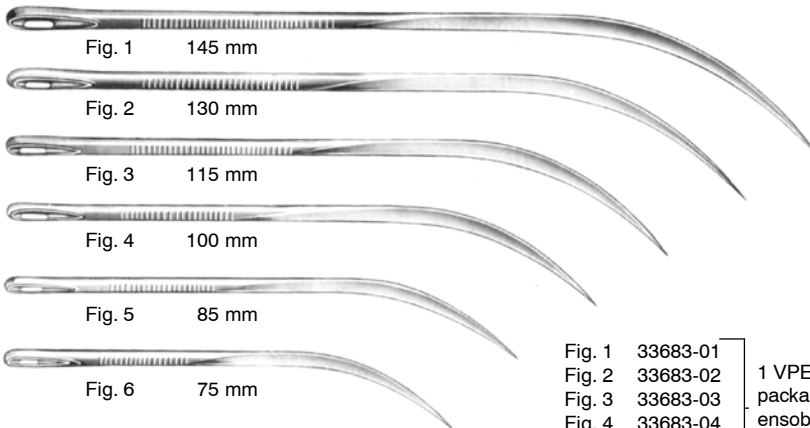


Fig. 1 145 mm

Fig. 2 130 mm

Fig. 3 115 mm

Fig. 4 100 mm

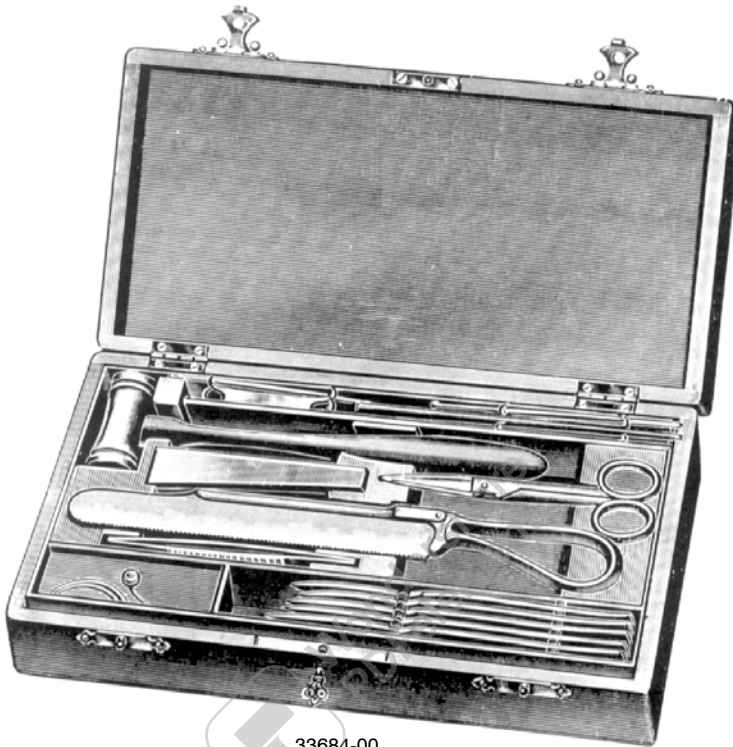
Fig. 5 85 mm

Fig. 6 75 mm

Fig. 1	33683-01
Fig. 2	33683-02
Fig. 3	33683-03
Fig. 4	33683-04
Fig. 5	33683-05
Fig. 6	33683-06

1 VPE = 12 Stk.
 package of 12
 sobres de 12
 confezione di 12

Obduktionsbesteck
Post Mortem Set
Estuches para Autopsia
Astucci per Autopsia



33684-00

Kleines Besteck, Holzetui, enthaltend:

- 4 Skalpelle
- 1 Knorpelmesser
- 1 Inzisionsschere, 13 cm (5 1/8")
- 1 Anatomische Pinzette, 13 cm (5 1/8")
- 1 Amputationssäge Charrière
- 1 Hammer
- 1 Meißel
- 2 doppelte Muskelhaken
- 2 doppelte Tubuli
- 2 Knopfsonden, 13 cm (5 1/8")
- 3 Wundnadeln

Modelo pequeño, estuche de madera, conteniendo:

- 4 Escalpelos
- 1 Cuchillo para cartilago
- 1 Tijera de incision, 13 cm (5 1/8")
- 1 Pinza para disección, 13 cm (5 1/8")
- 1 Sierra de amputación Charrière
- 1 Martillo
- 1 Escoplo
- 2 Separadores de 2 garfios, dobles
- 2 Tubos insufladores, dobles
- 2 Estiletes olivares, 13 cm (5 1/8")
- 3 Agujas para sutura

Small set, wooden case, containing:

- 4 Dissecting Knives
- 1 Cartilage Knife
- 1 Incision Scissors, 13 cm (5 1/8")
- 1 Dissecting Forceps, 13 cm (5 1/8")
- 1 Amputation Saw Charrière
- 1 Mallet
- 1 Chisel
- 2 Retractors, double ended
- 2 Blow pipes, double
- 2 Probes, 13 cm (5 1/8")
- 3 Suture Needles

Modelo piccolo, astuccio di legno, composto da:

- 4 Bisturi
- 1 Coltello per cartilagine
- 1 Forbice per incisione, 13 cm (5 1/8")
- 1 Pinza anatomica, 13 cm (5 1/8")
- 1 Segia per amputazione, Charrière
- 1 Martello
- 1 Scalpello
- 2 Divaricatori con 2 ganchi, doppi
- 2 Tubi inalatori, doppi
- 2 Specilli bottonuti, doppi, 13 cm (5 1/8")
- 3 Aghi per sutura

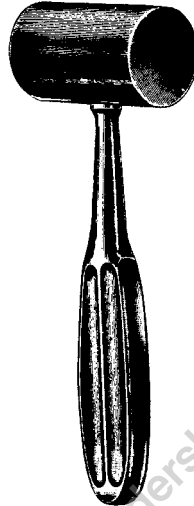
Hämmer
Mallets
Martillos
Martelli

Ø 25 mm



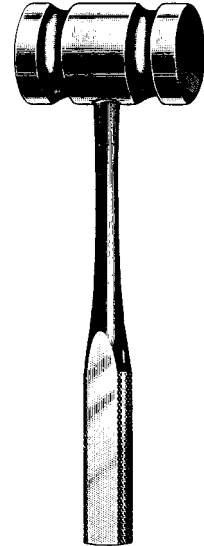
GERZOG
18 cm, 7"
33686-25 250 g

Ø 38 mm



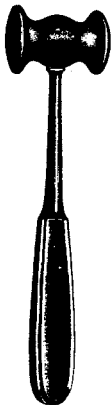
KIRK
19 cm, 7 1/2"
33687-75 750 g

Ø 34 mm

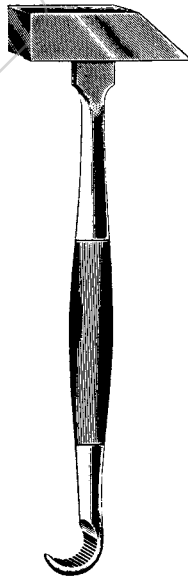


26,5 cm, 10 1/2"
33688-45 450 g
33689-90 900 g

Ø 30 mm



COLLIN
20 cm, 8"
33690-22 220 g



33699-00
23,5 cm, 9 1/4"
480 g

Ø 25 mm



135 g
33694-01 18,5 cm, 7 1/4"
33694-03 Ersatzbacken
Nylon Caps
Tapas de repuesto
Placche di ricambio

Hämmer Mallets Martillos Martelli



WILLIGER
24 cm, 9 1/2"
33691-34 340 g



LUCAE
19 cm, 7 1/2"
33692-26 260 g

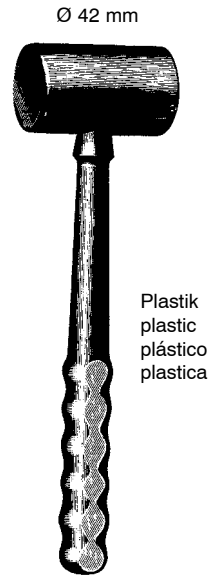
massiv, mit auswechselbaren Ferrozellbacken
solid, with interchangeable Ferrozell jaws
macizo, con tapas intercambiables de Ferrozell
solido, con placche intercambiabili in Ferrozell



33693-33
Paar Ersatzbacken
Pair spare jaws
par de tapas de repuesto
Coppia di placche di ricambio

33693-34
Satz Ringe
Set rings
juego de anillos
Set anelli

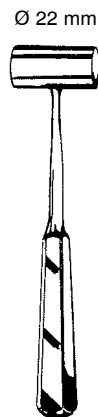
MEAD
17 cm, 6 3/4"
33693-32 320 g



26 cm, 10 1/4"
33695-40 400 g



QUISLING
33696-75



PARTSCH
33698-98
18 cm, 7"
199 g



33699-17
26,5 cm, 10 1/2"
530 g

Hämmer
Mallets
Martillos
Martelli

Ø 30 mm

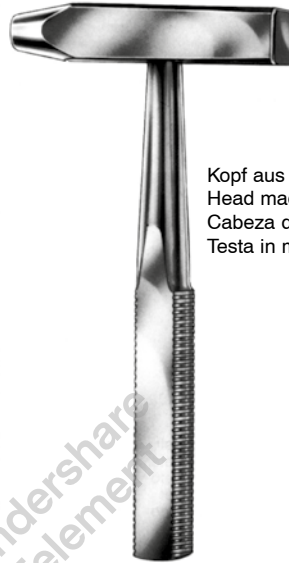


33700-01-01
Ersatzbacken
Nylon Caps
Tapas de repuesto
Placche di ricambio

24,5 cm, 9 3/4" 215 g
33700-01

Ø 10 mm

Ø 23 mm



Kopf aus Implantatwerkstoff
Head made of material used for implants
Cabeza de material de implantación
Testa in materiale per impianti

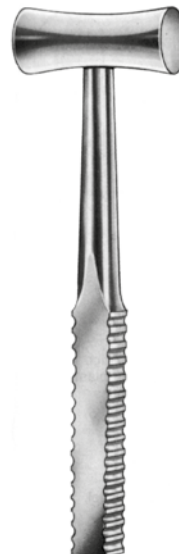
23 cm, 9" 350 g
33700-02

Ø 45 mm



BERGMANN
24 cm, 9 1/2" 300 g
33700-03

Ø 30 mm



BERGMANN
23 cm, 9" 300 g
33700-04

Hämmer
Bone Hammers and Mallets
Martillos y mazos
Martelli

Ø 30 mm



COTTLE
18 cm, 7" 240 g
33700-05

Ø 40 mm



HEATH
18 cm, 7" 700 g
33700-06

Ø 40 mm



OMBREDANNE
25 cm, 10" 700 g
33700-07

Ø 27 mm



HAJEK
21 cm, 8 1/4" 140 g
33700-08

Raspatorien
 Periosteal
 Periostótomos
 Periostotomi

12,5 mm



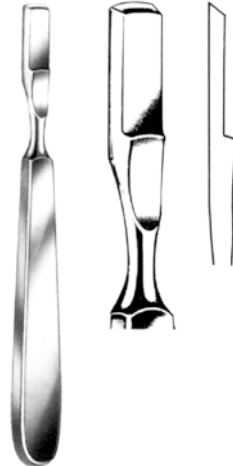
FARABEU
 33702-15
 15 cm, 5.9"

12,5 mm



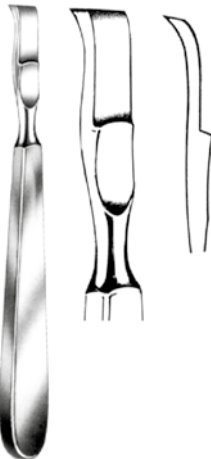
FARABEU
 33703-15
 15 cm, 5.9"

11 mm



FARABEU-COLLIN
 33704-01
 15,5 cm, 6"

11 mm



FARABEU-COLLIN
 33704-02
 15,5 cm, 6"

18 mm

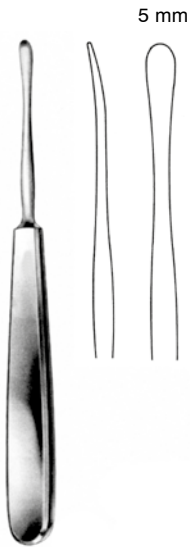


SEDILLOT
 18 cm, 7"
 33706-18

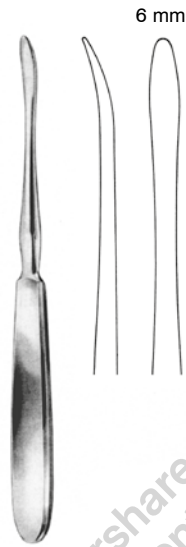
LAMBOTTE
 21 cm, 8 1/4"

33705-05 5 mm
 33705-10 10 mm
 33705-15 15 mm
 33705-20 20 mm
 33705-25 25 mm

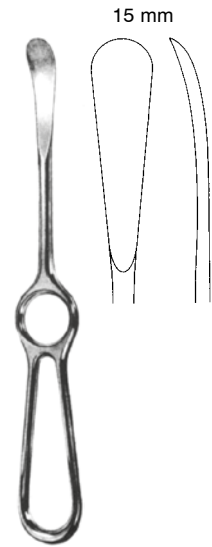
Elevatoren, Raspatorien
Elevatoren, Periosteal
Elevadores, Periostótomos
Elevatori, Periostotomi



SEBILLEAU
17,5 cm, 7"
33707-17



QUERVAIN
19,5 cm, 7 3/4"
33708-19



SEDILLOT
21 cm, 8 1/4"
33709-21



LANGENBECK
19 cm, 7 1/2"
33710-19



LANGENBECK
18 cm, 7"
33711-18



LANGENBECK
20 cm, 8"
33711-20 8 mm
33711-21 10 mm

Raspatorien, Elevatoren
Raspatories, Elevators
Periostótomos, Elevadores
Periostotomi, Elevatori

4 mm



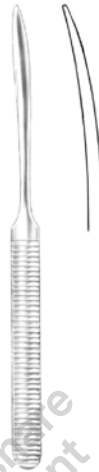
WILLIGER
33711-16
16 cm, 6 1/4"

6,5 mm



WILLIGER
33712-16
16 cm, 6 1/4"

5 mm



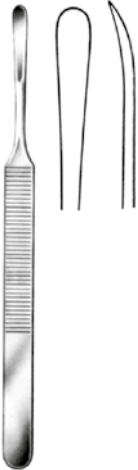
WILLIGER
33713-16
16 cm, 6 1/4"

5,5 mm



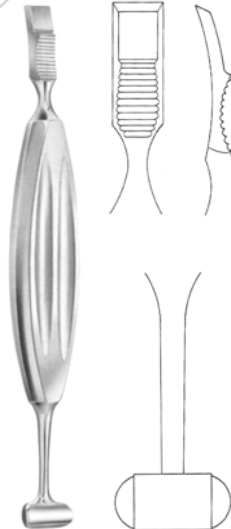
WILLIGER
33713-17
17 cm, 6 3/4"

5 mm

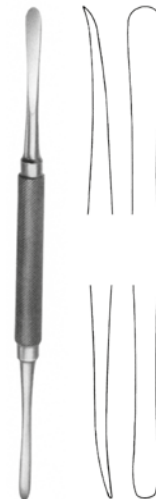


KÖNIG
33714-15
15,5 cm, 6"

12 mm

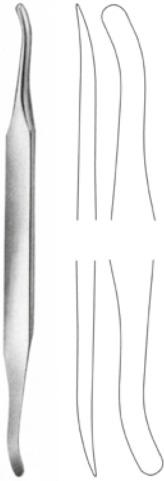


ALEXANDER
33715-20
21 cm, 8 1/4"

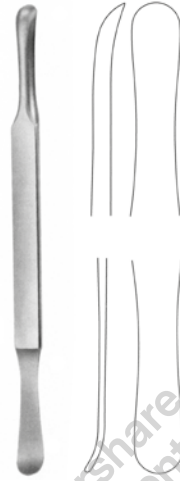


MOLT
33716-18
18 cm, 7"

Raspatorien, Elevatoren, Saugdissektor
 Raspatories, Elevators, Suction dissector
 Periostótomos, Elevadores, Disector con aspirador
 Periostotomi, Elevatori, Disettore aspiratore



SELDIN
 33717-19-01
 19,5 cm 7 3/4"



SELDIN
 33717-19-02
 19,5 cm 7 3/4"

4 mm



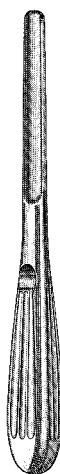
JOSEPH
 33718-16
 16 cm, 6 1/4"

4 mm



FOMON
 33719-17
 17 cm, 6 3/4"

9 mm

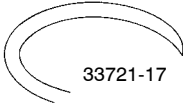


BOIES
 33720-19
 19 cm, 7 1/2"

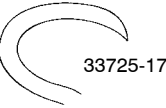


GORNEY
 33720-21
 21 cm, 8 1/4"

Raspatorien, Elevatoren
Periosteal Elevators
Periostótomos, Elevadores
Periostotomi, Elevatori

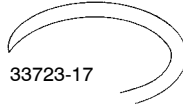


33721-17

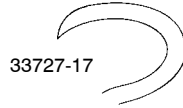


33725-17

L



33723-17



33727-17

R



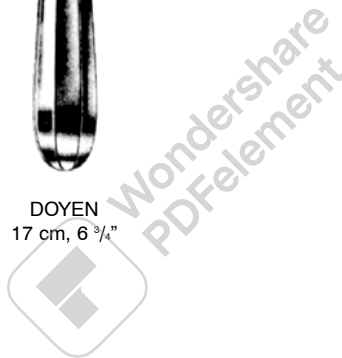
33728-24



33729-24

DOYEN
24 cm 9 1/2"

DOYEN
17 cm, 6 3/4"



SEMB

12 mm



33729-01
17,5 cm
7"

12 mm



33729-02
21 cm
8 1/4"

12 mm



33729-03
17,5 cm
7"

13 mm



33729-04
21 cm
8 1/4"

15 mm



33729-05
20,5 cm
8"

15 mm



33729-06
20,5 cm
8"



33729-07
22,5 cm
8.9"

Elevatoren, Raspatoren
Elevators, Raspatories
Elevadores, Periostótomos
Elevatori, Periostotomi



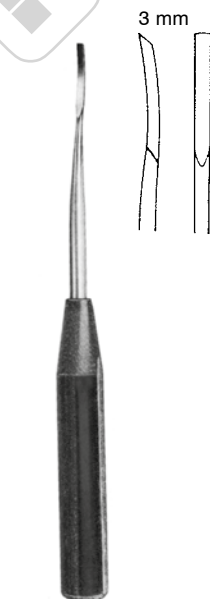
MATSON-ALEXANDER
33731-22
22 cm, 8 3/4"



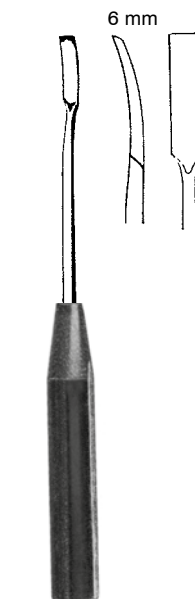
MATSON
33733-22
22 cm, 8 3/4"



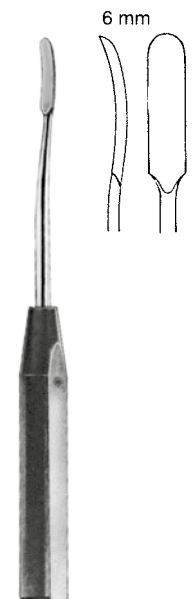
33740-19
19 cm, 7 1/2"



33741-18
18,5 cm, 7 1/4"



33742-18
18,5 cm, 7 1/4"

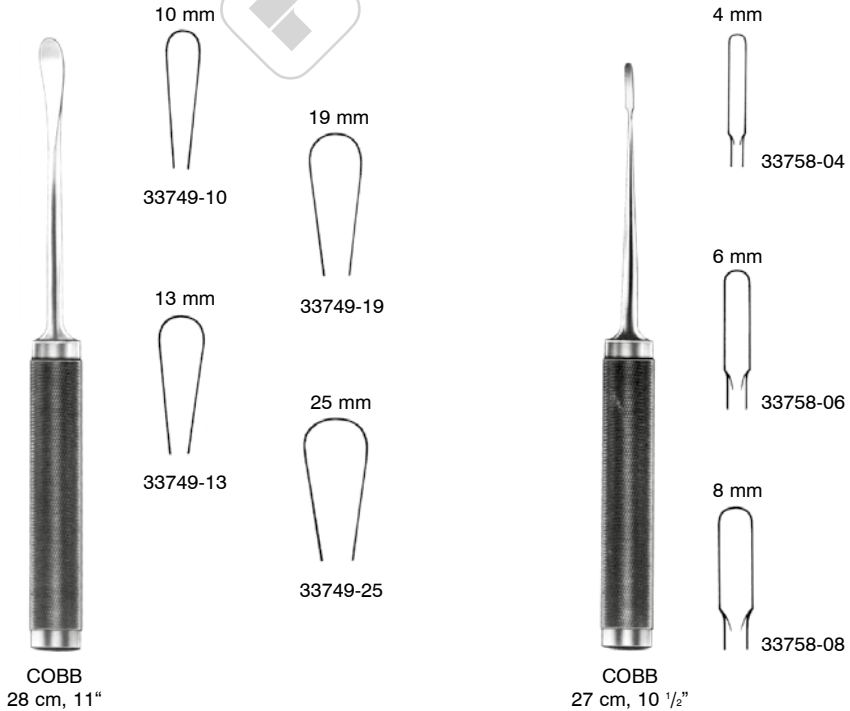
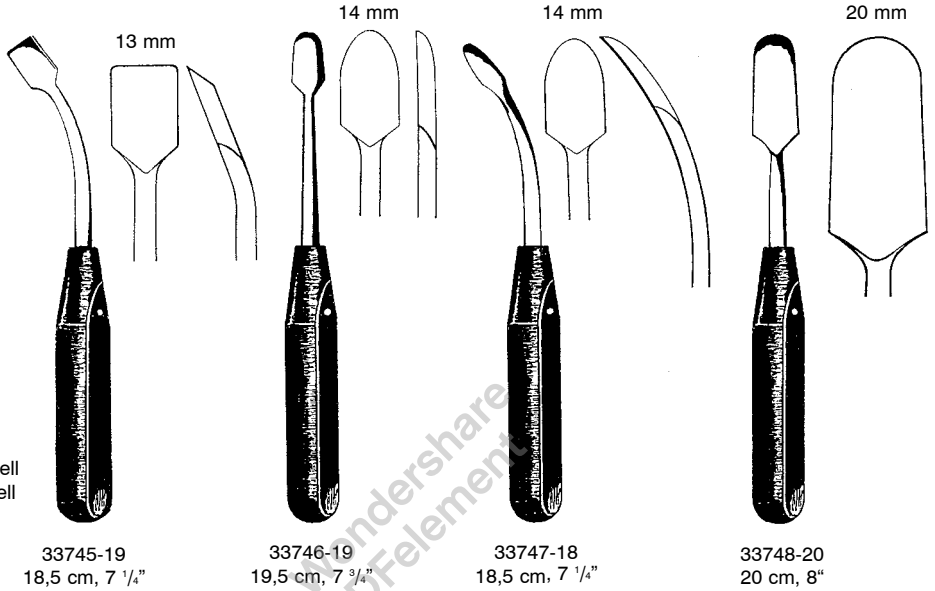


33743-18
18,5 cm, 7 1/4"

mit Ferrozellgriff
with Ferrozell-Handle
con mango de Ferrozell
con manico di Ferrozell

Elevatoren, Raspatoren
 Elevators, Raspatories
 Elevadores, Periostótomos
 Elevatori, Periostotomi

mit Ferrozellgriff
 with Ferrozell-Handle
 con mango de Ferrozell
 con manico di Ferrozell



Elevatoren
Elevators
Elevadores
Elevatori

scharf
sharp
cortante
tagliente



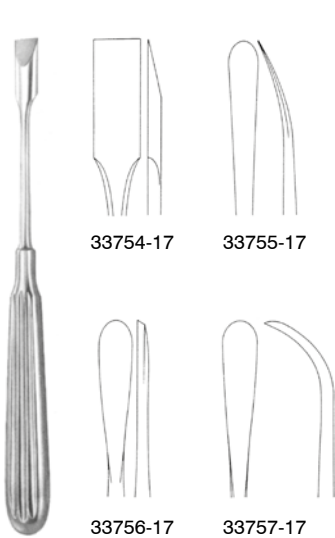
SAYRE
17 cm, 6 $\frac{3}{4}$ "
33758-01

stumpf
blunt
romo
smusso



SAYRE
17 cm, 6 $\frac{3}{4}$ "
33758-02

Raspatoren, Knochenheber, Dissektor
 Raspatories, Bone Levers, Dissectors
 Periostótomos para huesos, Disectores
 Periostotomi, Elevatori per ossa, Dissettori



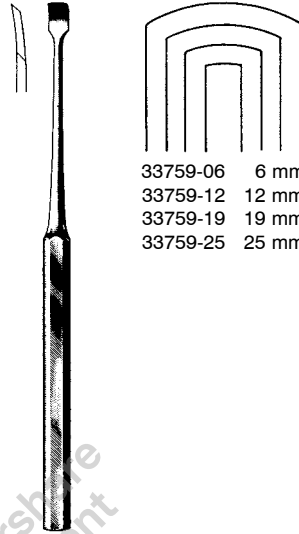
33754-17

33755-17

33756-17

33757-17

ADSON
 17 cm, 6 3/4"



33759-06 6 mm
 33759-12 12 mm
 33759-19 19 mm
 33759-25 25 mm

KEY
 33759-06 - 33759-25
 19 cm, 7 1/2"



CHANDLER
 33763-01 19,0 cm 7 1/2"
 33763-02 20,3 cm 8"
 33763-03 22,9 cm 9"
 33763-04 25,4 cm 10"



7 mm

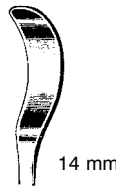


CREGO
 33760-01
 20 cm, 8"



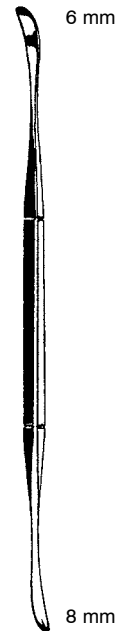
7 mm

33760-02



14 mm

33760-03

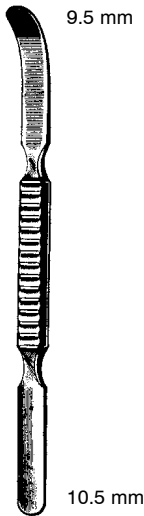


6 mm

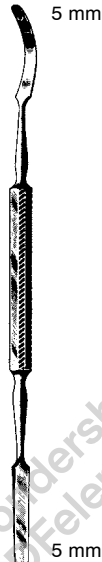
8 mm

ALDERDYCE
 33761-21
 21 cm, 8 1/4"

Elevatoren, Dissektor, Knochenheber
Elevators, Dissectors, Bone Levers
Elevadores para huesos, Disectores
Elevatori, Dissettori, Elevatori per ossa



WATSON-CHEYNE
33765-17
17,5 cm, 7"



MC DONALD
33767-19
19 cm, 7 1/2"



MURPHY-LANE
33769-30
30 cm, 11 3/4"



BENNETT
33771-71
26 cm, 10 1/4"



BENNETT
33771-73
26 cm, 10 1/4"

Knochenhebel
 Bone Levers
 Elevadores para huesos
 Elevatori per ossa



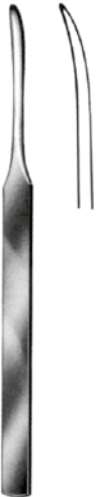
HOHMANN
 33801-08 8 mm
 33801-12 12 mm

HOHMANN
 33801-18 18 mm, 3/4"

HOHMANN
 33801-43 43 mm, 1 3/4"

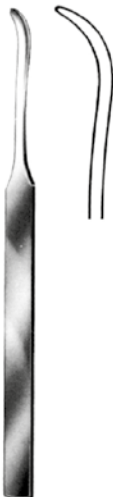
HOHMANN
 33801-70 70 mm, 2 3/4"

4,5 mm



KÖNIG
 33802-01 15 cm, 6"

4,5 mm



KÖNIG
 33802-02 15 cm, 6"

2,8 mm



33802-14 14 cm, 5 1/2"

5 mm



33803-05 15 cm, 6"

7 mm

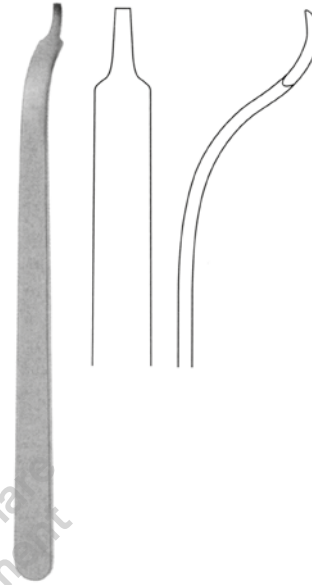


33803-07 15 cm, 6"

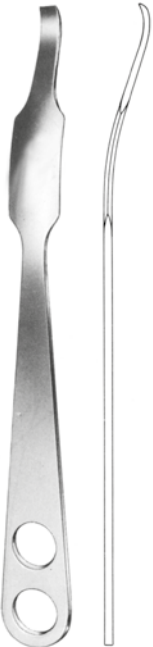
Knochenhebel
Bone Levers
Elevadores para huesos
Elevatori per ossa



HOHMANN
33803-43 43 mm



BUCK-GRAMCKO
33804-15 7,5 mm



HOHMANN
33805-22 22 mm



HOHMANN
33805-33 33 mm

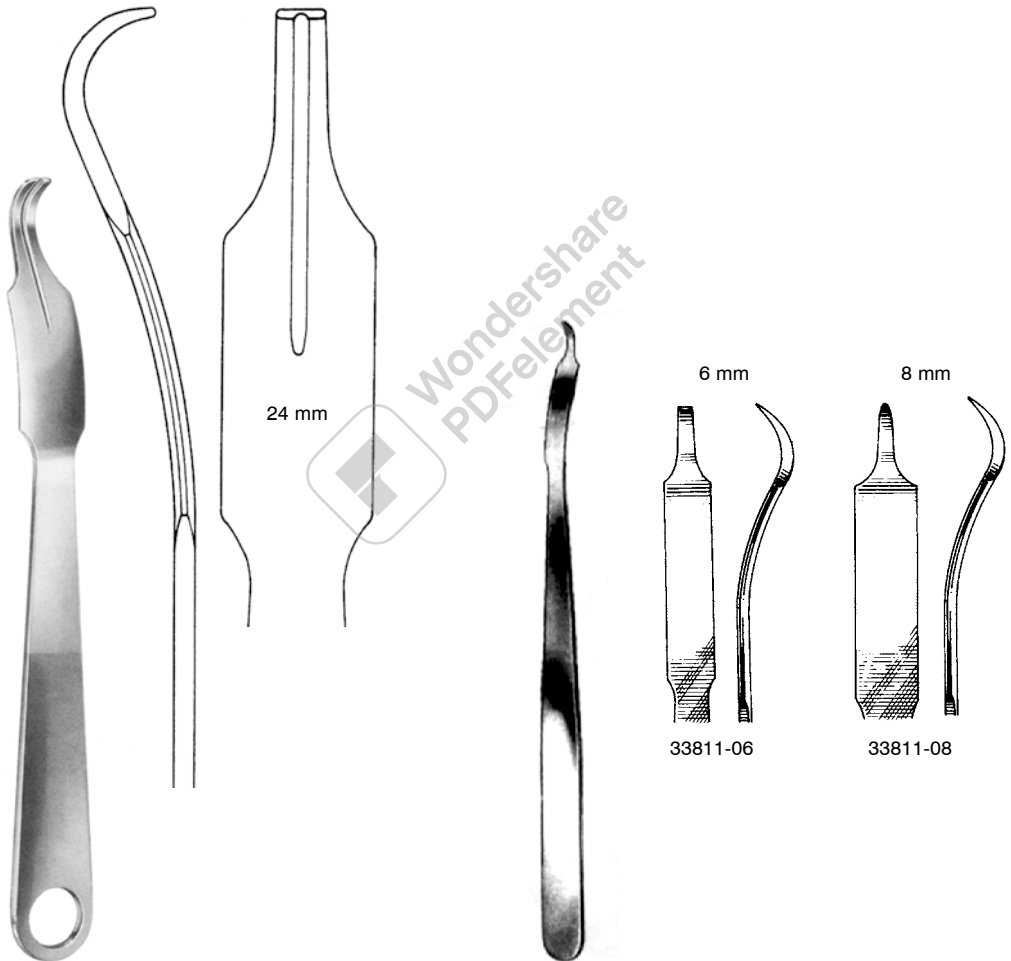


HOHMANN
33807-24 24 mm



HOHMANN
33809-22 22 mm

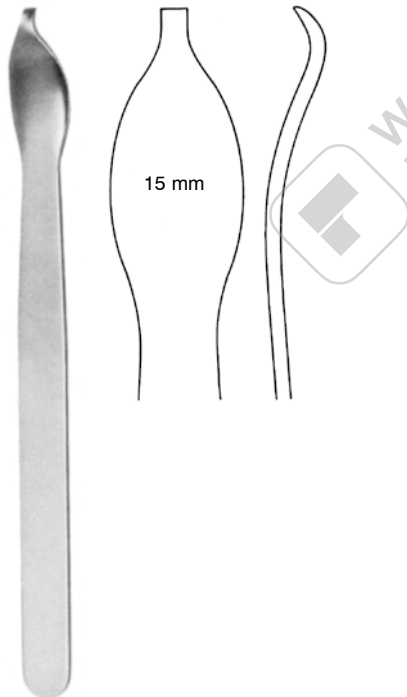
Knochenhebel
Bone Levers
Elevadores para huesos
Elevatori per ossa



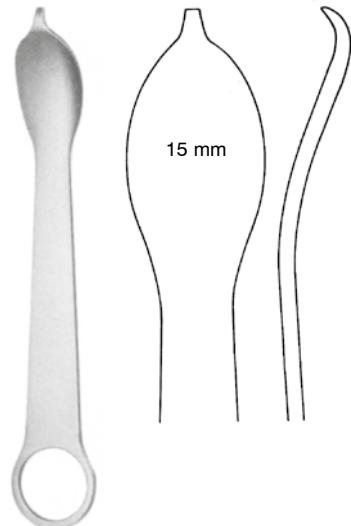
LANGE-HOHMANN
33810-24
25 cm, 10"

HOHMANN mini
16 cm, 6 1/4"

Knochenhebel
Bone Levers
Elevadores para huesos
Elevatori per ossa

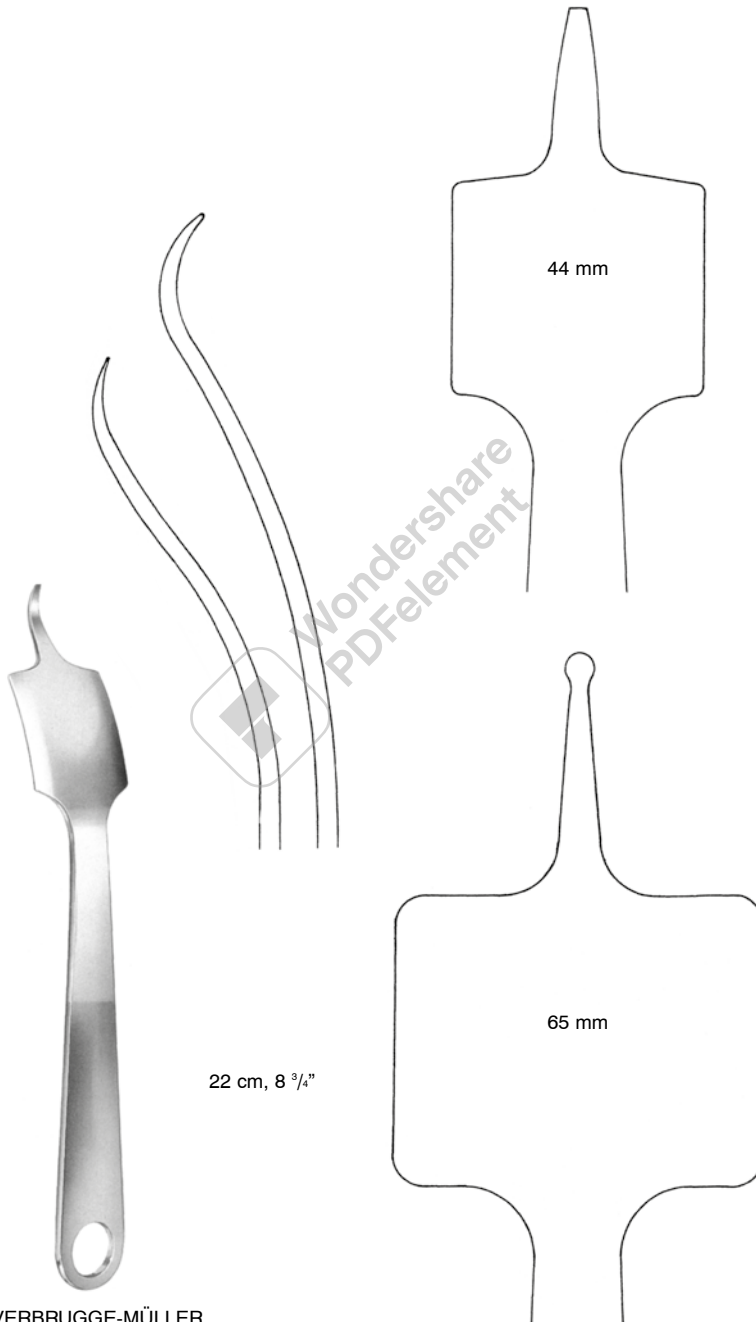


33812-16
16 cm, 6 1/4"



33813-12
12 cm, 4 3/4"

Knochenhebel
Bone Levers
Elevadores para huesos
Elevatori per ossa



22 cm, 8 ³/₄"

VERBRUGGE-MÜLLER
33814-44 24,0 cm, 9 ¹/₂"
33814-65 25,5 cm, 10"



Knochenhebel
Bone Levers
Elevadores para huesos
Elevatori per ossa

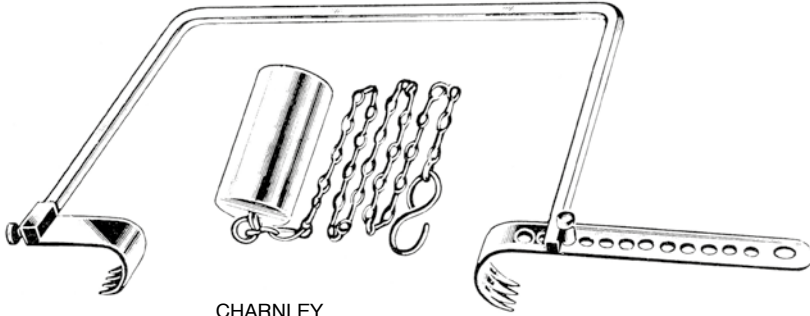


BLOUNT
33823-26
26 cm, 10 1/4"



BLOUNT
33825-26
26 cm, 10 1/4"

Retraktor, Knochenheber, Meniskushaken
 Retractor, Bone Levers, Meniscus Retractors
 Separador, Elevadores p. huesos, Separadores para menisco
 Divaricatori, Elevatori per ossa, Divaricatori per il menisco



CHARNLEY
33826-00

33826-01 spitz, gerieft
pointed tip, serrated
punta aguda, dentada
punta acuta, zigrinata

33826-02 stumpf, gerieft
blunt tip, serrated
punta roma, dentada
punta smussa, zigrinata

33826-03 stumpf, glatt
blunt tip, smooth
punta roma, lisa
punta smussa, liscia



AUFRANC-COBRA
26 cm 10 1/4"



BLOUNT
33827-17
17,5 cm 7"

Knochenhebel
Bone Levers
Elevadores p. huesos
Elevatori per ossa



LANE TRETOWAN
33828-21
21,5 cm 8 1/2"



LANE
33829-25
25,5 cm 10"



BRISTOW
33830-23
23 cm 9"

Knochenheber, Meniskushaken
 Bone Levers, Meniscus Retractors
 Elevadores p. huesos, Separadores para menisco
 Elevatori per ossa, Divaricatori per il menisco



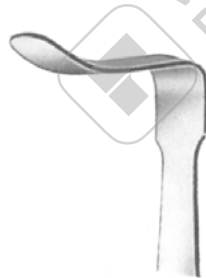
TAYLOR

16,5 cm, 6 1/2"

33831-16	75x30 mm
33833-16	100x30 mm



SMILLIE
 14 cm, 5 1/2"
 12 x 13 mm
 33832-01



SMILLIE
 14 cm, 5 1/2"
 52 x 13 mm
 33832-02



32 x 19 mm
 33832-03

48 x 19 mm
 33832-04

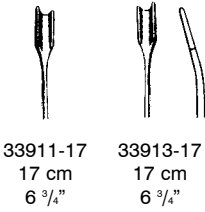
57 x 19 mm
 33832-05

SMILLIE
 14 cm, 5 1/2"

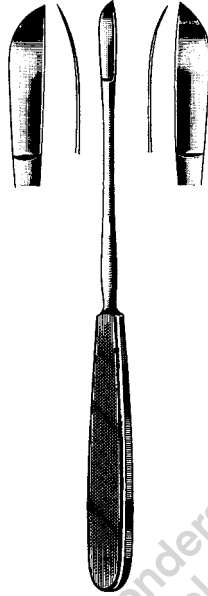
Sehenschäler, Sehnenfaßpinzette, Sehnenhaltezange, Sehnenfaßinstrumente
Tendon seizing instruments
Instrumentos para coger tendones
Enucleatore di tendine, Strumenti per afferrare tendini



SMILLIE
33910-17
17 cm, 6 3/4"



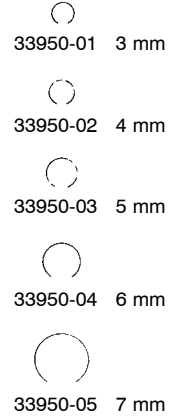
33911-17 17 cm 6 3/4"
33913-17 17 cm 6 3/4"



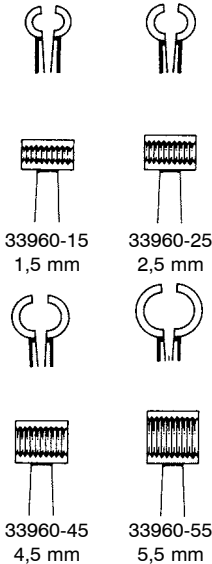
NEFF
33921-22 - 33923-22
22 cm, 8 3/4"



BUNELL
33950-01 - 33950-05
15 cm, 6"



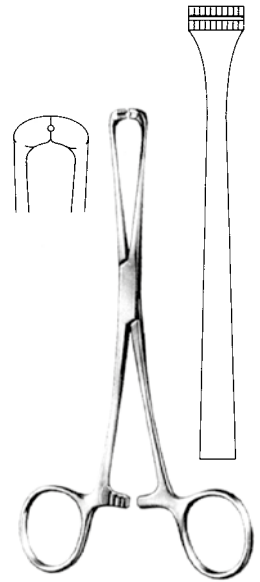
LARSEN
33960-15 - 33960-55
10 cm, 4"



33960-15 1,5 mm
33960-25 2,5 mm
33960-45 4,5 mm
33960-55 5,5 mm



JACKSON
33961-15
15 cm, 6"



STEINMANN
33962-16
16 cm, 6 1/4"

Sehnenfaßinstrumente, Sehnenführer
 Tendon seizing instruments, Tendon passing instr.
 Instrumentos para coger tendones, Instrumento p. el tunel del tendon
 Strumenti per afferrare tendini



33963-12
 12 cm, 4 3/4"



BRAND
 33964-15 - 33964-24



33964-15
 15 cm, 6"



33964-19
 19 cm, 7 1/2"



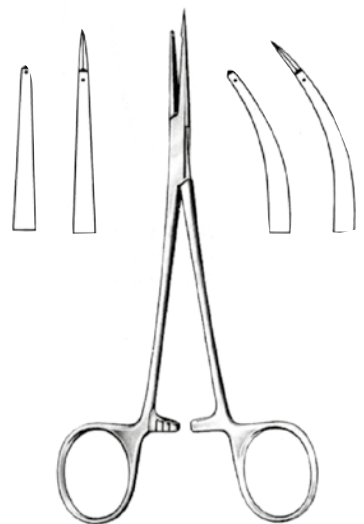
33964-24
 24 cm, 9 1/2"



BRAND
 33965-15 15 cm, 6"
 33965-19 19 cm, 7 1/2"
 33965-24 24 cm, 9 1/2"



CAROLL
 33966-11
 11 cm, 4 3/8"



33966-15 15 cm, 6" 33967-15

Sehnenfassinstrumente, Sehnenstripper, Knochenfeilen, Raspeln
 Tendon seizing instruments, Tendon Strippers, Bone Files, Raspers
 Instrumentos para coger tendones, Enucleadores de tendones, Limas, Escofinas
 Strumenti per afferrare tendini, Scollatendini, Lime per ossa, Raspe



KLEINERT-KUTZ
 33967-20
 20 cm, 8"



ø 3 mm
 33968-30
 30 cm, 11 3/4"



ø 6 mm
 33968-60
 50 cm, 19 1/2"

BRAND



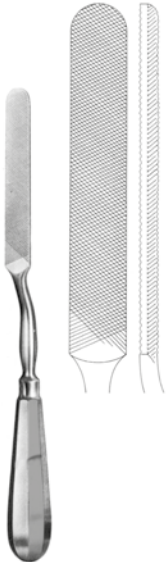
biegsam
 malleable
 maleable
 malleabile



biegsamer Schaft
 flexible shaft
 vastago maleabile
 camicia flessibile

BUNELL
 33969-18 18 cm, 7"
 33969-23 23 cm, 9"

BUNELL 23 cm
 33970-01 ø 4,0 mm
 33970-02 ø 4,5 mm
 33970-03 ø 5,5 mm



33971-24
 24,5 cm, 9 3/4"



33972-22
 22 cm, 8 3/4"



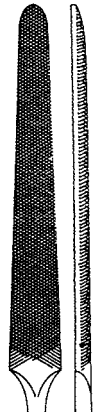
PUTTI
 33973-27
 27 cm, 10 1/2"



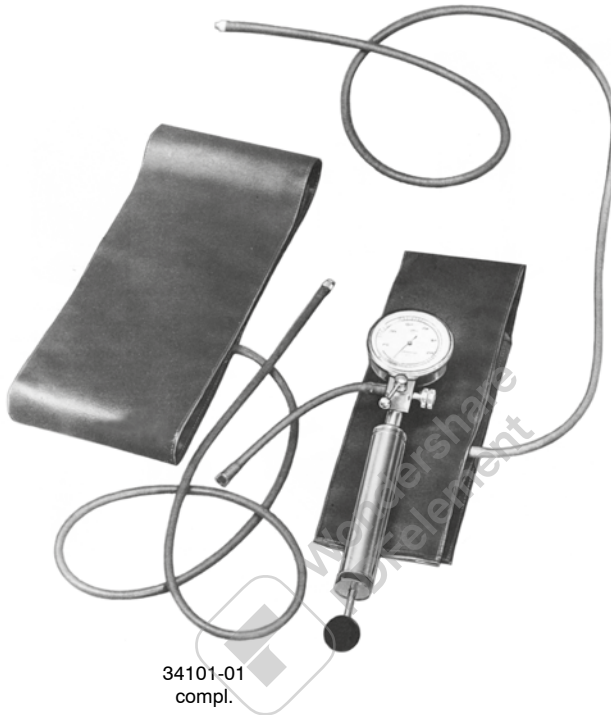
PUTTI
 33975-30
 30 cm, 11 3/4"



33977-28
 28 cm, 11"



Komprimeter
Pneumatic Tourniquet
Torniquete pneumático
Apparecchio di compressione



34101-01
compl.

Gerät zur Erzeugung von Bluteere in den Gliedmaßen
Compression Apparatus for producing blood vacuum in limbs
Aparato de compresión para producir el vacío de sangre en los miembros
Vacumentro per determinare vuoti di sangue nelle membra

34101-02
Pumpe
Air Pump
Bomba de aire
Pompa di aria

34101-03
Manometer
Manometer
Manómetro
Manometro

34101-04
Oberarmmanschette
Cuff for upper arm
Brazalete (brazo)
Bracciale
34101-06 incl.

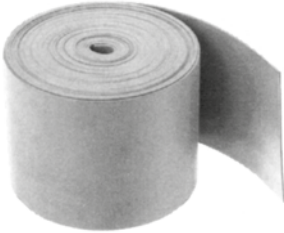
34101-05
Oberschenkelmanschette
Cuff (leg)
Brazalete (pierna)
Cosciale
34101-07 incl.

34101-06
Polster für Oberarmmanschette 46 x 6 cm (18" x 2.4")
Bandage cuff for arm 46 x 6 cm (18" x 2.4")
Colchon para brazaletes para brazo 46 x 6 cm (18" x 2.4")
Bracciale per braccio superiore 46 x 6 cm (18" x 2.4")

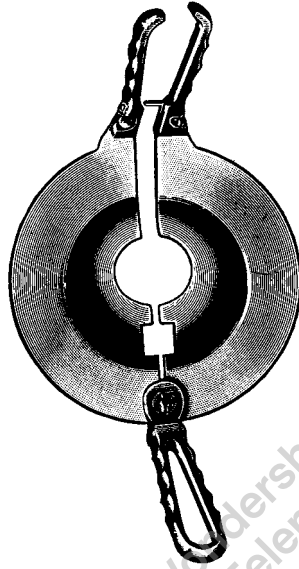
34101-07
Polster für Oberschenkelmanschette 55 x 10 cm (21 1/2 x 10")
Bandage cuff for leg 55 x 10 cm (21 1/2 x 10")
Colchon para brazaletes para el femur 55 x 10 cm (21 1/2 x 10")
Bracciale per coscia superiore 55 x 10 cm (21 1/2 x 10")

Amputations- und Resektionssägen
Amputation and Resection Saws
Sierras para amputación y resección
Seghe per amputazione e resezione

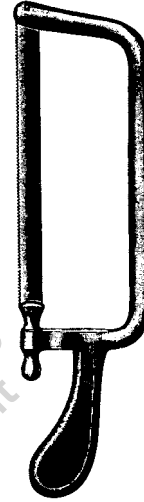
Staubbinde
Compression bandage
Vendaje de compresión
Benda per compressione
5 m lang / long
6 cm breit / wide



ESMARCH
34105-01



PERCY
34110-00



CHARRIERE
34112-00
35 cm, 13 3/4"

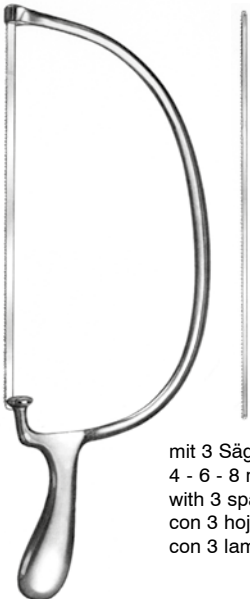
34112-01
12 mm

Ersatzsägeblätter
Spare saw blades
Hojas de sierra de
repuesto
Lame di ricambio

34112-02
15 mm

Ersatzsägeblätter
Spare saw blades
Hojas de sierra de
repuesto
Lame di ricambio

komplett mit 2 Blättern
complete with 2 blades
completo con 2 hojas
completa con 2 lame

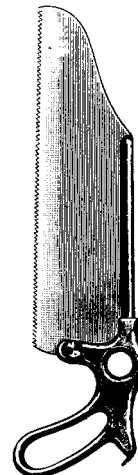


mit 3 Sägeblätter
4 - 6 - 8 mm
with 3 spare blade
con 3 hojas de repuesto
con 3 lame di ricambio

BIER
34114-39
40,5 cm, 16"



CHARRIERE
34116-30
30 cm, 11 3/4"



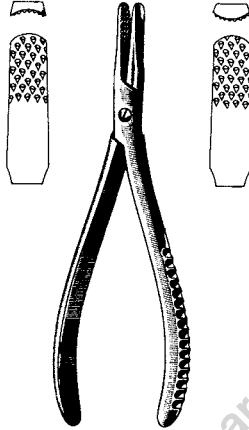
SATTERLEE
34118-31
31 cm, 12 1/4"

34118-99
Sägeblatt
blade
hoja
lama



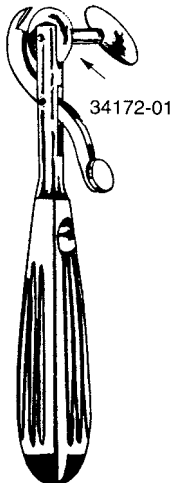
LANGENBECK
34120-23
23 cm, 9"

Nagelausreißzange, Fingerringsägen
 Fcps. f. tearing out finger nails, Finger Ring Saws
 Pinzas para arrancar uñas, Sierras para abrir anillos
 Pinze per lacerazione delle unghie, Seghe per anelli



RADOLF

34161-13 13,5 cm, 5 1/4" 3 mm
 34162-13 13,5 cm, 5 1/4" 6 mm



WALTON
 34172-00
 16 cm, 6 1/4"

Sägeblatt
 Saw blade
 Hoja de sierra
 Lama di ricambio

34172-01

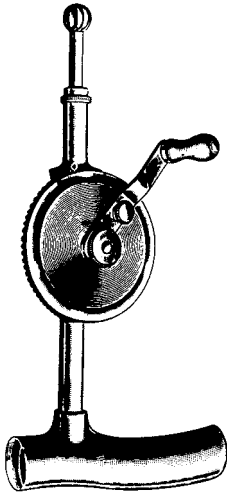


HADEO
 34175-00
 17 cm, 6 3/4"

Sägeblatt
 Saw blade
 Hoja de sierra
 Lama di ricambio

34175-01

Bohrapparate, Bohrlochzange
 Bone Hand Drills, Forceps for Bone Hole
 Perforador de mano, Pinza de guía
 Perforatori a mano, Pinza per perforatione



STILLE
 34210-20 20 cm, 8"
 compl. incl. 34212-25 - 34214-16



34212-25
 2,5 mm



34212-30
 3,0 mm



34212-35
 3,5 mm



34212-40
 4,0 mm



34214-05
 10 mm



34214-08
 5 mm



34214-10
 8 mm



34214-12
 12 mm



34214-16
 16 mm



34216-10
 1,0 mm



34216-15
 1,5 mm



34216-20
 2,0 mm



STILLE-SHERMAN
 34220-24 24 cm, 9 1/2"
 compl. incl. 34222-25 - 34222-35



34222-25
 2,5 mm



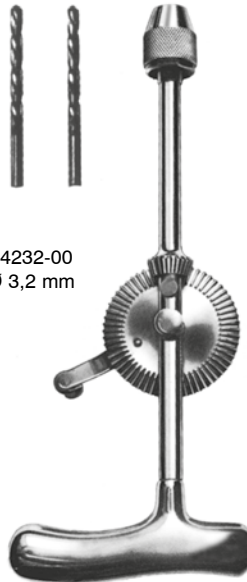
34222-30
 3,0 mm



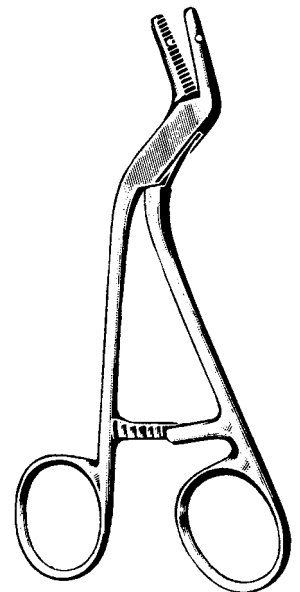
34222-35
 3,5 mm



34232-00
 Ø 3,2 mm



MOORE
 34230-28 28 cm, 11"
 compl. incl. 34232-00



ADSON
 34231-15
 15 cm, 6"

Bohrapparate
Bone Hand Drills
Perforador de mano
Perforatori a mano



34241-00
Griff allein
Handle only
Mango solo
Manico solo

HUDSON

34240-27 27 cm, 10 1/2"
compl. incl. 34242-09, -14, -16, -22,
34246-00



34242-09
9 mm



34242-14
14 mm



34242-16
16 mm



34242-22
22 mm



ø 2 mm
34243-02



CUSHING
34244-10
34244-14
34244-16



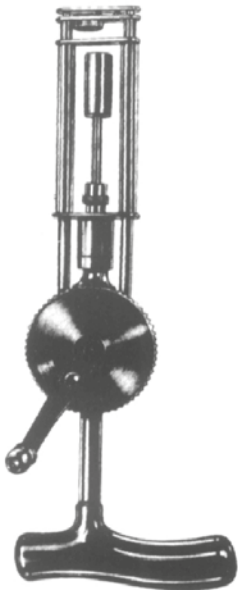
ERRICO
34244-17
ø 16 mm



MC KENZIE
34248-00
ø 13 mm



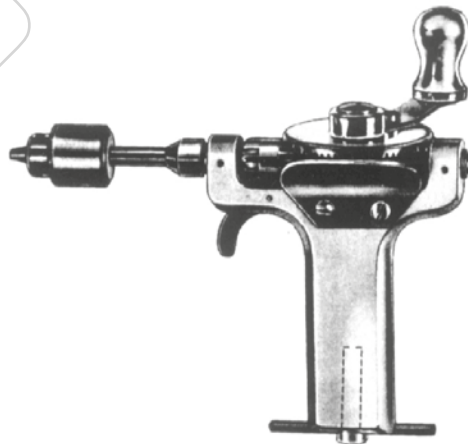
34246-00
Verlängerungsstück
Extension piece
Pieza alargadera
Giunto di prolungamento



KIRSCHNER
34250-00 compl.



34252-00



34270-01
Schlüssel
Wrench
Llave
Chiave

BUNELL

34270-00 16 cm, 6 1/4"

Bohrapparat 16 cm (6 1/4"), längsdurchbohrt mit Dreibackenspannfutter und Schlüssel, Spannweite bis 4 mm

Hand drill, 16 cm (6 1/4"), longitudinally bored, with three-jaw-chuck and key, opening up to 4 mm

Perforador manual, 16 cm (6 1/4"), taladrado longitudinalmente, con mandril de tres mordazas y llave, abriendo hasta 4 mm

Perforatore a mano, 16 cm (6 1/4"), con perforazione assiale, con mandrino a tre ganasce e chiave, apertura fino a 4 mm di D.

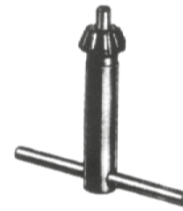
Bohrapparate, Handgriffe
Bone Hand Drills, Handles
Perforador de mano
Perforatori a mano, manici



RALK
34280-00



HADEO
34290-00



34295-00



34296-00

Spannschlüssel allein
Key only
Llave suelta
Chiave solo

Handgriff mit Jacobs-
spannfutter und Spann-
schlüssel bis 3,6 mm
Handle with Jacobs chuck
and key to 3,6 mm
Mango con cierre Jacobs,
de 3 mordazas y llave a
3,6 mm
Manico con mandrino di
Jacobs e chiave a 3,6 mm

Bohrapparat mit Leichtmetallgehäuse, mit Dreibackenspannfutter und Schlüssel, Spannweite bis D. 6,35 mm
Hand drill with light metal case, with three-jaw-chuck and key, opening up to D. 6,35 mm
Perforador manual con caja de aluminio, con mandril de tres mordazas y llave, abriendo hasta 6,35 mm de D.
Perforatore a mano con cassa in metallo leggero, con mandrino a tre ganasce e chiave, apertura fino a 6,35 mm di D.

Handbohrapparat mit umstellbarem Handgriff, mit Jacobs Dreibackenspannfutter und Schlüssel
Hand drill with adjustable handle, with Jacobs three-jaw-chuck and wrench
Perforador de mano en T con cierre Jacobs de 3 mordazas y llave de ajuste
Perforatore a mano con manico regolabile, con mandrino a tre ganasce di Jacobs e chiave



34296-05

T-Handgriff, verriegelbares schlüsselloses Dreibackenspannfutter, rostfrei
T-handle, keyless locking chuck
Mango en T, mordaza sin llave, inox.
Chiave a T con mandrino a tre ganasce inox



34296-10

Handgriff, Dreibackenspannfutter, inkl. Spannschlüssel rostfrei
Handle with chuck, including key
Mango, mordaza incluyendo llave, inox.
Mandrino a tre ganasce con manico recto completo di chiave di arresto inox



34296-15

"Hudson" T-Handgriff, Schnellkupplung
Hudson T-handle with fast gripping chuck
Mango en T, acople rápido
Hudson: mandrino con manico a T
Ganasce con raccordo rapido



34296-20

Schnellkupplungs T-Handgriff, groß
T-handle with fast gripping chuck, large
Mango en T, acople rápido, grande
Mandrino a T manico grande
Raccordo rapido

Schnellkupplungs-Handgriffe
Handles with quick-action chuck
Mangos de acople rápido
Manici con attachi rapidi



34296-25
Schnellkupplungs-T-Handgriff
T-Handle, quick-action
Mango en T, acople rápido
Mandrino a T con raccordo rapido



34296-30
Schnellkupplungs-Handgriff
groß mit Hartgewebegriff
Handle, quick-action, large,
handle made of very hard fibre
Mango de acople rápido,
grande, de material extraduro
Mandrino grande rapido con
manico a fibre dure



34296-35
Schnellkupplungs-Handgriff
mit Hartgewebegriff
Handle, quick-action,
made of very hard fibre
Mango de acople rápido,
de material extra-duro
Mandrino medio rapido con
manico a fibre dure



34296-40
Mini Schnellkupplungs-Handgriff
für „Dental“-Anschluß
Mini-Handle, quick-action,
"dental"
Mini-Mango de acople rápido
"dental"
Mini mandrino-rapido con
impugnatura cilindrica con
attacco dentale

Bohrer
Drill bits
Taladros
Perforatore



Ø		
1,0 mm	56 mm	34320-10
1,5 mm	70 mm	34320-15
2,0 mm	85 mm	34320-20
2,5 mm	95 mm	34320-25
2,7 mm	100 mm	34320-27
3,0 mm	100 mm	34320-30
3,2 mm	106 mm	34320-32
3,5 mm	112 mm	34320-35
4,0 mm	119 mm	34320-40
4,5 mm	126 mm	34320-45
5,0 mm	132 mm	34320-50
6,0 mm	139 mm	34320-60
7,0 mm	156 mm	34320-70



Ø		
1,0 mm	180 mm	34321-10
1,5 mm	180 mm	34321-15
2,0 mm	180 mm	34321-20
2,5 mm	180 mm	34321-25
2,7 mm	180 mm	34321-27
3,0 mm	180 mm	34321-30
3,2 mm	180 mm	34321-32
3,5 mm	180 mm	34321-35
4,0 mm	180 mm	34321-40
4,5 mm	180 mm	34321-45
5,0 mm	180 mm	34321-50
6,0 mm	180 mm	34321-60
6,5 mm	180 mm	34321-65
7,0 mm	180 mm	34321-70
8,0 mm	180 mm	34321-80
9,0 mm	180 mm	34321-90
10,0 mm	180 mm	34322-00

Spiralbohrer mit Glattschaft
Twist Drills with round end
Taladros espirales con vástago redondo
Perforatore elicoidale

Spiralbohrer mit Glattschaft langes Modell
Twist Drills, long typ
Taladros espirales, largos
Perforatore elicoidale, modello lungo



Ø		
1,1 mm	60 mm	34322-11
1,5 mm	85 mm	34322-15
2,0 mm	100 mm	34322-20
2,5 mm	110 mm	34322-25
2,7 mm	100 mm	34322-27
3,2 mm	145 mm	34322-32
3,5 mm	110 mm	34322-35
4,5 mm	145 mm	34322-45

Spiralbohrer mit Schnellkupplungs-Ansatz
Twist Drills, quick-action
Taladros espirales, acople rápido
Perforatore elicoidale con attacco rapido



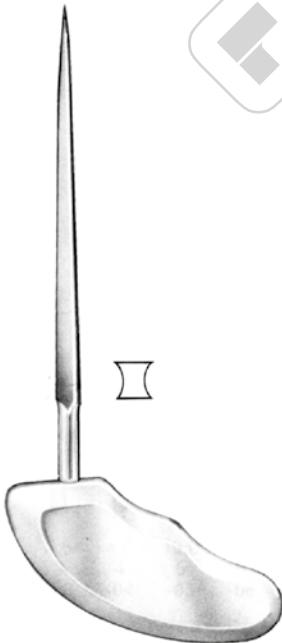
Pfrieme, Reibahle
Awl, Reamer
Escariadores
Lesine, Punteruoli



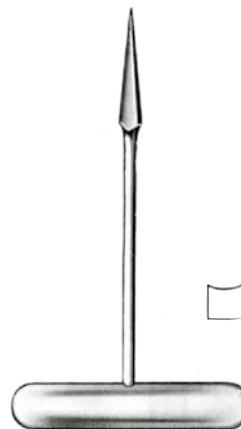
34392-14
14 cm, 5 1/2"



PERTHES
34393-18
18 cm, 7"



PERTHES
34393-21
21 cm, 8 1/4"



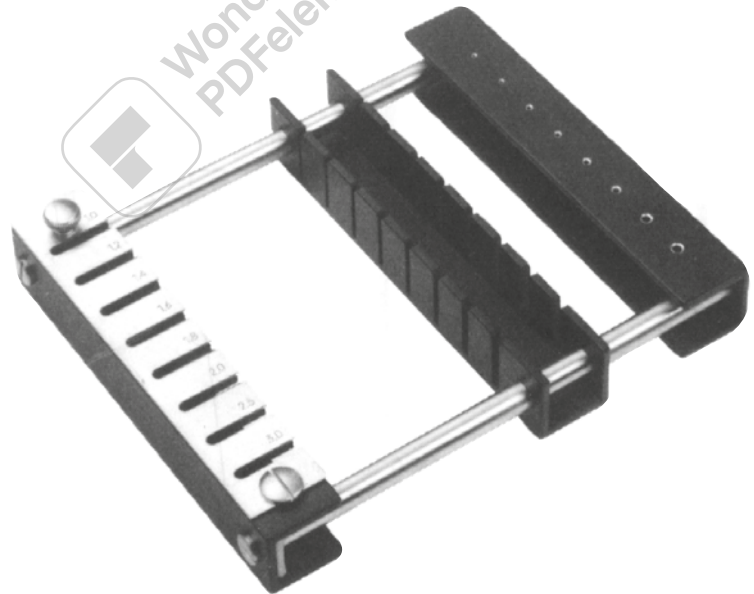
34394-14
14 cm, 5 1/2"

Wondershare
PDFelement

Faßpinzette, Bohrdrachtspender
 Grasping forceps, Support for sterilisation
 Pinzas para coger, Soporte de esterilización
 Pinze per afferrare, Supporto per la sterilizzazione



34439-00



Bohrdrachtspender für Kirschner-Drähte
 Support for sterilisation of Kirschner wires
 Soporte de esterilización p. alambres de Kirschner
 Supporto per la sterilizzazione dei fili di Kirschner

34440-01 bis 15 cm – up to 15 cm (6") – hasta 15 cm – fino a 15 cm
 34440-02 bis 31 cm – up to 31 cm (12 1/4") – hasta 31 cm – fino a 31 cm
 34440-03 bis 10 cm – up to 10 cm (4") – hasta 10 cm – fino a 10 cm

Bohrdrähte
Drill Wires
Alambres
Perforatori filiformi

lieferbar in Packungen à 10 Stück
available in packages of 10 pieces
disponible en paquets de 10 unidades
disponibili solo in confezioni da 10 pezzi

Trokarspitze / Trocar point
Punta trocar / Punte trequarti

Ø	10 cm, 4"	15 cm, 6"	31 cm, 12 1/4"
0,8	34401-08	34402-08	34403-08
1,0	34401-10	34402-10	34403-10
1,1	34401-11	34402-11	34403-11
1,2	34401-12	34402-12	34403-12
1,3	34401-13	34402-13	34403-13
1,4	34401-14	34402-14	34403-14
1,5	34401-15	34402-15	34403-15
1,6	34401-16	34402-16	34403-16
1,7	34401-17	34402-17	34403-17
1,8	34401-18	34402-18	34403-18
1,9	34401-19	34402-19	34403-19
2,0	34401-20	34402-20	34403-20
2,2	34401-22	34402-22	34403-22
2,3	34401-23	34402-23	34403-23
2,4	34401-24	34402-24	34403-24
2,5	34401-25	34402-25	34403-25
2,8	34401-28	34402-28	34403-28
3,0	34401-30	34402-30	34403-30

Kirschner
mit rundem Ende / with round shaft
con extremo redondo / con estremo rotondo

Trokarspitze / Trocar point
Punta trocar / Punte trequarti

Ø	10 cm, 4"	15 cm, 6"	31 cm, 12 1/4"
0,8	34404-08	34405-08	34406-08
0,9	34404-09	34405-09	34406-09
1,0	34404-10	34405-10	34406-10
1,1	34404-11	34405-11	34406-11
1,2	34404-12	34405-12	34406-12
1,3	34404-13	34405-13	34406-13
1,4	34404-14	34405-14	34406-14
1,5	34404-15	34405-15	34406-15
1,6	34404-16	34405-16	34406-16
1,7	34404-17	34405-17	34406-17
1,8	34404-18	34405-18	34406-18
1,9	34404-19	34405-19	34406-19
2,0	34404-20	34405-20	34406-20
2,2	34404-22	34405-22	34406-22
2,3	34404-23	34405-23	34406-23
2,4	34404-24	34405-24	34406-24
2,5	34404-25	34405-25	34406-25
2,8	34404-28	34405-28	34406-28
3,0	34404-30	34405-30	34406-30

Kirschner
mit flachem Ende / with flat shaft
con extremo plano / con estremo piatto

Trokarspitze / Trocar point
Punta trocar / Punte trequarti

Ø	10 cm, 4"	15 cm, 6"	31 cm, 12 1/4"
0,8	34407-08	34408-08	34409-08
0,9	34407-09	34408-09	34409-09
1,0	34407-10	34408-10	34409-10
1,1	34407-11	34408-11	34409-11
1,2	34407-12	34408-12	34409-12
1,3	34407-13	34408-13	34409-13
1,4	34407-14	34408-14	34409-14
1,5	34407-15	34408-15	34409-15
1,6	34407-16	34408-16	34409-16
1,7	34407-17	34408-17	34409-17
1,8	34407-18	34408-18	34409-18
1,9	34407-19	34408-19	34409-19
2,0	34407-20	34408-20	34409-20
2,2	34407-22	34408-22	34409-22
2,3	34407-23	34408-23	34409-23
2,4	34407-24	34408-24	34409-24
2,5	34407-25	34408-25	34409-25
2,8	34407-28	34408-28	34409-28
3,0	34407-30	34408-30	34409-30

Kirschner
Trokarende / Trocar shaft
Punta trocar / Punte trequarti Bilaterali

Lanzenspitze / Lance point
Punta lanceolar / Punte lanceolata


Ø	31 cm, 12 1/4"
0,8	34410-08
0,9	34410-09
1,0	34410-10
1,1	34410-11
1,2	34410-12
1,3	34410-13
1,4	34410-14
1,5	34410-15
1,6	34410-16
1,7	34410-17
1,8	34410-18
1,9	34410-19
2,0	34410-20
2,2	34410-22
2,3	34410-23
2,4	34410-24
2,5	34410-25
2,8	34410-28
3,0	34410-30

Kirschner
mit flachem Ende / with flat shaft
con extremo plano / con estremo piatto

lieferbar in Packungen à 10 Stück
available in packages of 10 pieces
disponible en paquets de 10 unidades
disponibili solo in confezioni da 10 pezzi


Bohrdrähte, Knochennägel
Drill Wires, Fracture pins
Alambres, Clavos para huesos
Perforatori filiformi, Chiodi per ossa

Lanzenspitze / Lance point
Punta lanceolar / Punta lanceolata



Ø	31 cm, 12 1/4"
0,8	34411-08
0,9	34411-09
1,0	34411-10
1,1	34411-11
1,2	34411-12
1,3	34411-13
1,4	34411-14
1,5	34411-15
1,6	34411-16
1,7	34411-17
1,8	34411-18
1,9	34411-19
2,0	34411-20
2,2	34411-22
2,3	34411-23
2,4	34411-24
2,5	34411-25
2,8	34411-28
3,0	34411-30

Trokarspitze / Trocar point
Punta trocar / Punta trequarti




	Ø	Ø	Ø	Ø	Ø
	3,5 mm	4,0 mm	4,5 mm	5,0 mm	6,0 mm
8 cm, 3 1/8"	34412-08	34413-08	34415-08	34417-08	34419-08
10 cm, 4"	34412-10	34413-10	34415-10	34417-10	34419-10
12 cm, 4 3/4"	34412-12	34413-12	34415-12	34417-12	34419-12
14 cm, 5 1/2"	34412-14	34413-14	34415-14	34417-14	34419-14
16 cm, 6 1/4"	34412-16	34413-16	34415-16	34417-16	34419-16
18 cm, 7"	34412-18	34413-18	34415-18	34417-18	34419-18
20 cm, 8"	34412-20	34413-20	34415-20	34417-20	34419-20
22 cm, 8 3/4"	34412-22	34413-22	34415-22	34417-22	34419-22
23 cm, 9"	34412-23	34413-23	34415-23	34417-23	34419-23
24 cm, 9 1/2"	34412-24	34413-24	34415-24	34417-24	34419-24
26 cm, 10 1/4"	34412-26	34413-26	34415-26	34417-26	34419-26
28 cm, 11"	34412-28	34413-28	34415-28	34417-28	34419-28
30 cm, 11 3/4"	34412-30	34413-30	34415-30	34417-30	34419-30

Kirschner
mit rundem Ende / with round shaft
con extremo redondo / con estremo rotondo

Steinmann
mit rundem Ende / with round shaft
con extremo redondo / con estremo rotondo

Trokarspitze / Trocar point
Punta trocar / Punta trequarti




	Ø	Ø	Ø	Ø	Ø
	3,5 mm	4,0 mm	4,5 mm	5,0 mm	6,0 mm
8 cm, 3 1/8"	34420-08	34421-08	34423-08	34425-08	34427-08
10 cm, 4"	34420-10	34421-10	34423-10	34425-10	34427-10
12 cm, 4 3/4"	34420-12	34421-12	34423-12	34425-12	34427-12
14 cm, 5 1/2"	34420-14	34421-14	34423-14	34425-14	34427-14
16 cm, 6 1/4"	34420-16	34421-16	34423-16	34425-16	34427-16
18 cm, 7"	34420-18	34421-18	34423-18	34425-18	34427-18
20 cm, 8"	34420-20	34421-20	34423-20	34425-20	34427-20
22 cm, 8 3/4"	34420-22	34421-22	34423-22	34425-22	34427-22
23 cm, 9"	34420-23	34421-23	34423-23	34425-23	34427-23
24 cm, 9 1/2"	34420-24	34421-24	34423-24	34425-24	34427-24
26 cm, 10 1/4"	34420-26	34421-26	34423-26	34425-26	34427-26
28 cm, 11"	34420-28	34421-28	34423-28	34425-28	34427-28
30 cm, 11 3/4"	34420-30	34421-30	34423-30	34425-30	34427-30

Steinmann
Trokarende / Trocar shaft
Punta trocar / Punta trequarti Bilateriali

Knochennägel
Fracture pins
Clavos para huesos
Chiodi per ossa

lieferbar in Packungen à 10 Stück
available in packages of 10 pieces
disponible en paquets de 10 unidades
disponibili solo in confezioni da 10 pezzi


Trokarspitze / Trocar point
Punta trocar / Punta trequarti



	Ø	Ø	Ø	Ø	Ø
	3,5 mm	4,0 mm	4,5 mm	5,0 mm	6,0 mm
8 cm, 3 1/8"	34428-08	34429-08	34431-08	34433-08	34435-08
10 cm, 4"	34428-10	34429-10	34431-10	34433-10	34435-10
12 cm, 4 3/4"	34428-12	34429-12	34431-12	34433-12	34435-12
14 cm, 5 1/2"	34428-14	34429-14	34431-14	34433-14	34435-14
16 cm, 6 1/4"	34428-16	34429-16	34431-16	34433-16	34435-16
18 cm, 7"	34428-18	34429-18	34431-18	34433-18	34435-18
20 cm, 8"	34428-20	34429-20	34431-20	34433-20	34435-20
22 cm, 8 3/4"	34428-22	34429-22	34431-22	34433-22	34435-22
23 cm, 9"	34428-23	34429-23	34431-23	34433-23	34435-23
24 cm, 9 1/2"	34428-24	34429-24	34431-24	34433-24	34435-24
26 cm, 10 1/4"	34428-26	34429-26	34431-26	34433-26	34435-26
28 cm, 11"	34428-28	34429-28	34431-28	34433-28	34435-28
30 cm, 11 3/4"	34428-30	34429-30	34431-30	34433-30	34435-30

Steinmann
mit 3-kant-Ende / with triangular end
con extremo triangular / con estremo triangolare

Trokarspitze / Trocar point
Punta trocar / Punta trequarti



mit Gewinde
threaded Wires
con rosca
con filetto

25 mm

	Ø	15 cm, 6"	18 cm, 7"	20 cm, 8"	23 cm, 9"	25 cm, 10"	31 cm, 12 1/4"
	1,6	34436-16	34437-16	34438-16	34439-16	34440-16	34441-16
	1,8	34436-18	34437-18	34438-18	34439-18	34440-18	34441-18
	2,0	34436-20	34437-20	34438-20	34439-20	34440-20	34441-20
	2,5	34436-25	34437-25	34438-25	34439-25	34440-25	34441-25
	2,8	34436-28	34437-28	34438-28	34439-28	34440-28	34441-28
	3,0	34436-30	34437-30	34438-30	34439-30	34440-30	34441-30

mit rundem Ende / with round shaft
con extremo redondo / con estremo rotondo

lieferbar in Packungen à 10 Stück
available in packages of 10 pieces
disponible en paquets de 10 unidades
disponibili solo in confezioni da 10 pezzi

Knochennägel
Fracture pins
Clavos para huesos
Chiodi per ossa

Trokarspitze / Trocar point
Punta trocar / Punta trequarti

mit Gewinde
threaded Wires
con rosca
con filetto



Ø	15 cm, 6"	18 cm, 7"	20 cm, 8"	23 cm, 9"	25 cm, 10"	31 cm, 12 1/4"
1,6	34442-16	34443-16	34444-16	34445-16	34446-16	34447-16
1,8	34442-18	34443-18	34444-18	34445-18	34446-18	34447-18
2,0	34442-20	34443-20	34444-20	34445-20	34446-20	34447-20
2,5	34442-25	34443-25	34444-25	34445-25	34446-25	34447-25
2,8	34442-28	34443-28	34444-28	34445-28	34446-28	34447-28
3,0	34442-30	34443-30	34444-30	34445-30	34446-30	34447-30

Trokarende / Trocar shaft
Punta trocar / Punta trequarti



Bohrdrahtspender
K-Wire Dispenser
Dispensador para brocas filiformes
Distributore per fili

12 cm, 4 3/4"



17 cm, 6 3/4"



33 cm, 13"



34450-08 0,8 mm
34450-10 1,0 mm
34450-12 1,2 mm
34450-14 1,4 mm
34450-15 1,5 mm
34450-16 1,6 mm
34450-18 1,8 mm
34450-20 2,0 mm
34450-22 2,2 mm
34450-25 2,5 mm
34450-30 3,0 mm

34460-08 0,8 mm
34460-10 1,0 mm
34460-12 1,2 mm
34460-14 1,4 mm
34460-15 1,5 mm
34460-16 1,6 mm
34460-20 2,0 mm
34460-22 2,2 mm
34460-25 2,5 mm
34460-30 3,0 mm

34470-08 0,8 mm
34470-10 1,0 mm
34470-12 1,2 mm
34470-14 1,4 mm
34470-15 1,5 mm
34470-16 1,6 mm
34470-20 2,0 mm
34470-22 2,2 mm
34470-25 2,5 mm
34470-30 3,0 mm

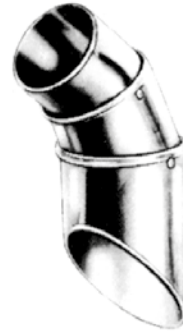
Fingerschützer, Drahtgeflecht
 Finger Protectors, Wire gauze
 Dedales, Gasa metálica
 Proteggidita, maglia metallica per estensione



34480-01



34480-02



34480-03

LANGENBECK
 34480-01 - 34480-03



34492-01

klein / small / pequeño / stretto

34492-02

mittel / medium / mediano / medio

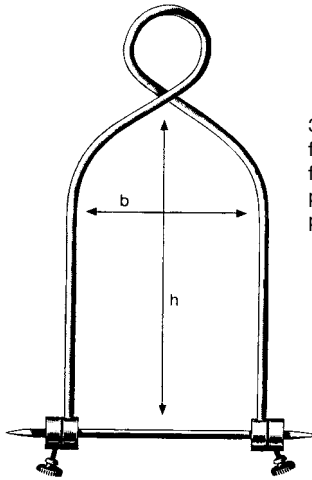
34492-03

groß / large / grande / grande

34492-01 - 34492-03

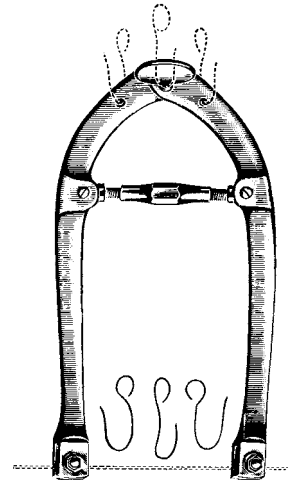
sterilisierbar
 sterilizable
 esterilizabile
 sterilizzabile

Extensionsbügel
Extension Bows
Estribos para extensión
Archi per estensione



34502-16
für Arm
for arm
para brazo
per braccio

16 x 9 cm
6 1/4" x 3 1/2"

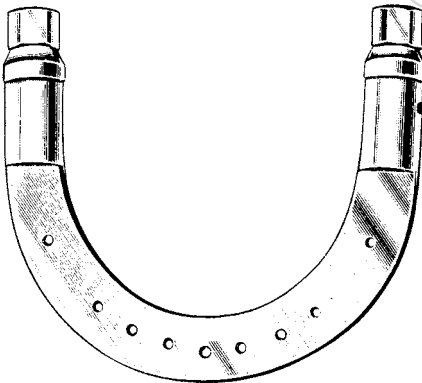


KIRSCHNER

BÖHLER
34502-15 21 x 15 cm 8 1/4" x 6"
34502-21 21 x 11 cm 8 1/4" x 4 3/8"
für Oberschenkel und Knie
for thigh and knee
para femur y rodilla
per femore e ginocchio

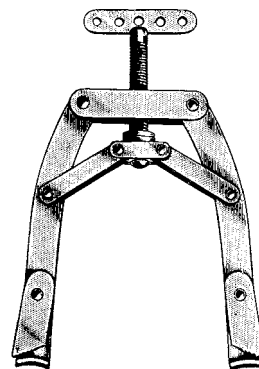
34514-18 40 - 140 mm x 115 mm mit 3 Zughaken
with 3 hooks
con 3 ganchos
con 3 ganci per trazione

34514-27 60 - 220 mm x 175 mm mit 3 Zughaken
with 3 hooks
con 3 ganchos
con 3 ganci per trazione



KIRSCHNER

34515-09 9,5 x 7,0 cm 3 3/4" x 2 3/4"
34515-10 9,5 x 11,0 cm 3 3/4" x 4 3/8"
34515-11 10,5 x 10,0 cm 4.1" x 4"
34515-12 12,0 x 12,0 cm 4 3/4" x 4 3/4"
34515-13 13,5 x 13,0 cm 5 1/4" x 5 1/8"
34515-15 15,5 x 15,5 cm 6" x 6"
34515-20 20,0 x 15,5 cm 8" x 6"



KIRSCHNER U.S.

34518-01
mittel, medium, mediano, max. 130 mm (5 1/8")
34518-02
groß, large, grande, grande, max. 185 mm (7 1/4")

34518-03
extra groß, large extra long, muy grande, max. 220 mm (8 3/4")

Spannschlüssel, Zughaken
Tightening wrench, hooks
Llave tensora, ganchos
Chiave, ganci per trazione



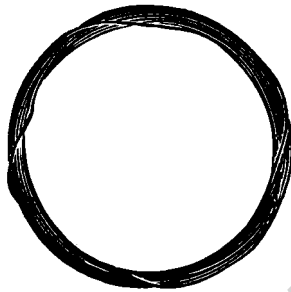
34515-01



34515-02

KIRSCHNER
34519-01KIRSCHNER
34519-02

Knochendraht
Bone wire
Hilos para huesos
Filo per ossa



weich, in Ringen zu 10 m (32,8 Feet)
soft, in coils of 10 m (32,8 Feet)
blando, de 10 m (32,8 Feet)
morbido, 10 m (32,8 Feet)

Material:
nichtrostender Implantatstahl
nach DIN 17443 (ISO 5832/1)

	mm Ø
34520-02	0,2
34520-03	0,3
34520-04	0,4
34520-05	0,5
34520-06	0,6
34520-07	0,7
34520-08	0,8
34520-09	0,9
34520-10	1,0
34520-12	1,2
34520-15	1,5

Drahtumföhrungsnadeln, Drahtspanninstrumente
 Bone wire guides, Bone wire tighteners
 Agujas pasa-hilos, Tensor cierra-hilos
 Aghi passafili, Strumenti tendifili



DEMEL

27 cm, 10 1/2"

Fig. 1 34528-01

Fig. 2 34528-02

Fig. 3 34528-03

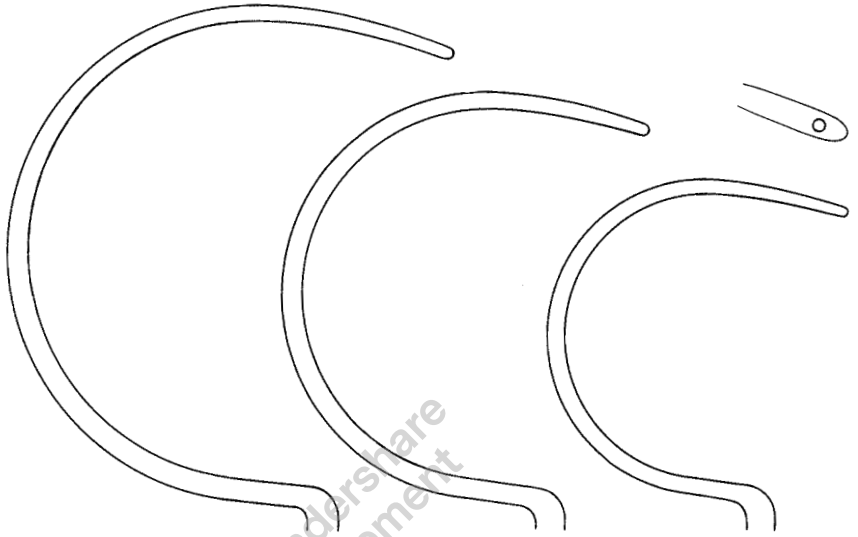
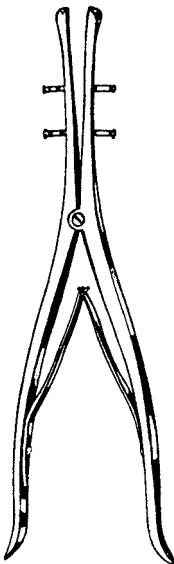


Fig. 1

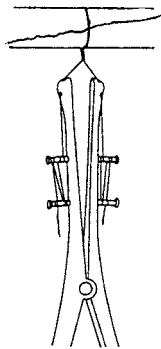
Fig. 2

Fig. 3



DEMEL

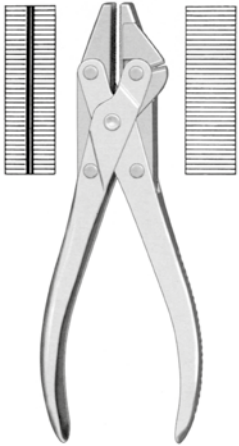
34530-28 28 cm, 11"



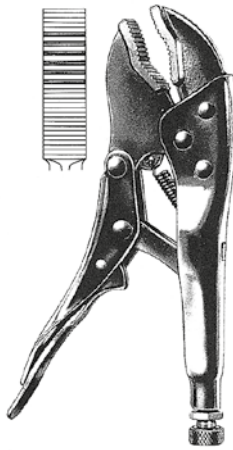
LOUTE

34531-21 21 cm, 8 1/4"

Flachzangen, Faßzangen
 Flat Nose Pliers, Seizing Forceps
 Alicates planos, Pinzas para coger alambres
 Tenaglie piatte, Tenaglie per afferrare



17 cm, 6 3/4"
 34533-17



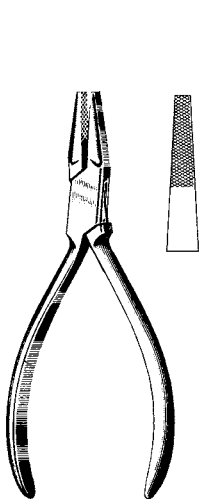
GRIP
 18 cm, 7"
 34534-18



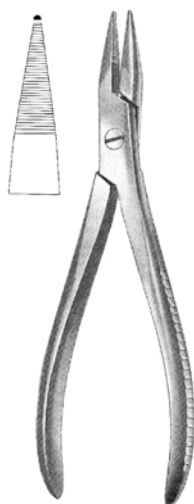
34534-15
 15 cm, 6"



34535-16
 16 cm, 6 1/4"



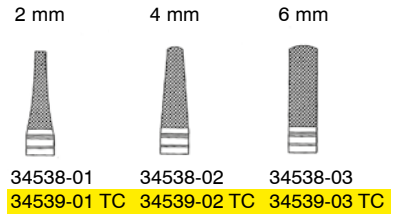
34536-14
 14 cm, 5 1/2"



34537-19
 19 cm, 7 1/2"



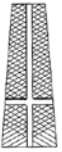
18 cm, 7"



Flachzangen, Drahtkneifzangen
Flat Nose Pliers, Wire cutting Pliers
Alicates planos, Alicates para cortar alambres
Tenaglie piatte, Tenaglie tagliafili



34540-01



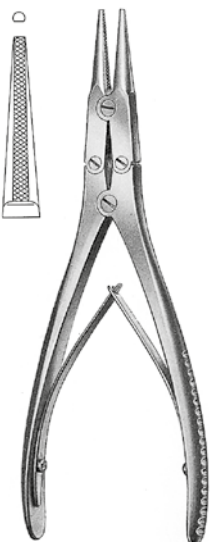
34540-02



17 cm, 6 3/4"

34540-16
16 cm, 6 1/4"

soft wire 2,0 mm

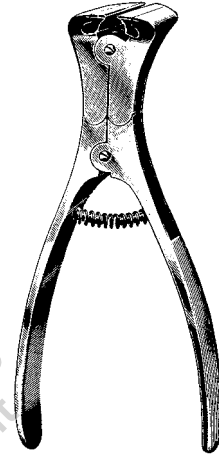
34540-18
18 cm, 7"34540-19
18 cm, 7"34540-20
20 cm, 8"

Drahtkneifzangen
Wire cutting Pliers
Alicates para cortar alambres
Tenaglie tagliafili



34541-23 TC 23 cm, 9"

soft wire 3,0 mm
hard wire 2,2 mm



34542-15 TC 15 cm, 6"

Soft wire 2,0 mm
hard wire 1,5 mm



34543-23 TC 23 cm, 9"

Soft wire 3,5 mm
hard wire 2,5 mm

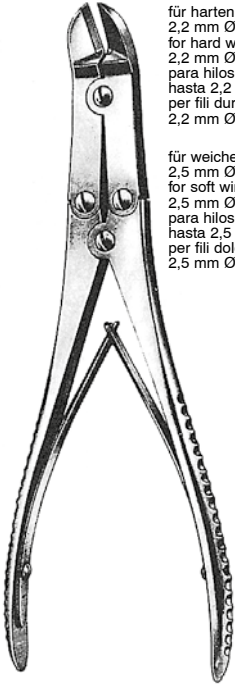


34544-18 TC 18 cm, 7"

Soft wire 2,5 mm
hard wire 1,5 mm



Drahtkneifzangen, Drahtfaßzangen
 Wire Cutting Pliers, Wire Seizing Forceps
 Alicates para cortar alambres, Pinzas para coger alambres
 Tronchese taglienti, Tenaglie per afferrare i fili



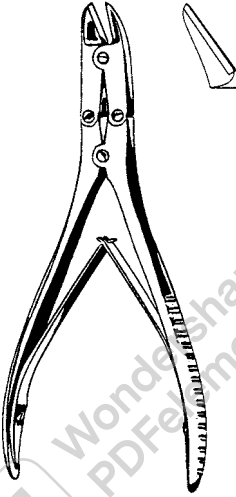
für harten Draht bis 2,2 mm Ø
 for hard wires up to 2,2 mm Ø
 para hilos duros hasta 2,2 mm Ø
 per fili duri a 2,2 mm Ø

für weichen Draht bis 2,5 mm Ø
 for soft wires up to 2,5 mm Ø
 para hilos blandos hasta 2,5 mm Ø
 per fili dolci fino a 2,5 mm Ø

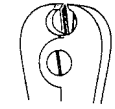
34545-22 TC 22 cm, 8 3/4"

für harten Draht bis 1,6 mm Ø
 for hard wires up to 1,6 mm Ø
 para hilos duros hasta 1,6 mm Ø
 per fili duri a 1,6 mm Ø

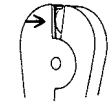
für weichen Draht bis 2,0 mm Ø
 for soft wires up to 2,0 mm Ø
 para hilos blandos hasta 2,0 mm Ø
 per fili dolci fino a 2,0 mm Ø



34546-16 TC 16 cm, 6 1/4"
 34546-18 TC 18 cm, 7"



für weichen Draht bis 2,0 mm Ø
 for soft wires up to 2,0 mm Ø
 para hilos blandos hasta 2,0 mm Ø
 per fili dolci fino a 2,0 mm Ø



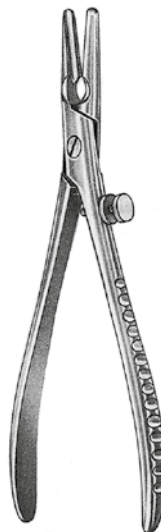
für harten Draht bis 1,6 mm Ø
 for hard wires up to 1,6 mm Ø
 para hilos duros hasta 1,6 mm Ø
 per fili duri a 1,6 mm Ø

34548-18 TC 18 cm, 7"

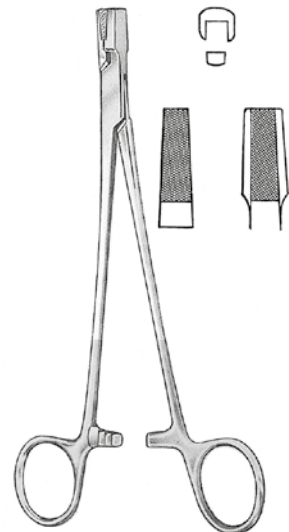


soft wire 1,5 mm
 hard wire 1,0 mm

34549-14 TC 14 cm, 5 1/2"

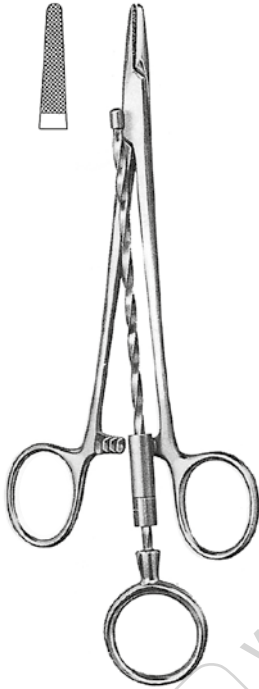


34550-13 13 cm, 5 1/8"
 34550-18 18 cm, 7"



34551-17 TC 17 cm, 6 3/4"

Drahtzangen
Wire Twisting Forceps
Pinzas para torcer hilos
Pinza torcifili



CORWIN-HEGAR
34552-16 TC 16 cm, 6 1/4"



BERRY
34556-18 TC 18 cm, 7"



MAYO-HABERISSER

34554-15 TC 15 cm 6" 34555-15 TC

34554-18 TC 18 cm 7" 34555-18 TC

34554-20 TC 20 cm 8" 34555-20 TC

Drahtkneifzange
Pin cutter
Alicates para cortar clavos
Ghigliottina per tagliare fili fino

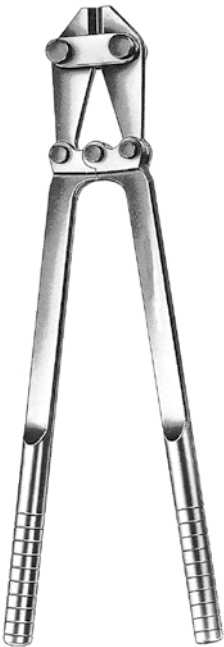


34557-22 22 cm, 8 3/4"
34557-25 25 cm, 10"
34557-30 30 cm, 11 3/4"



34558-32 32 cm, 12 1/2"

bis 2.2 mm
up to 2.2 mm
hasta 2.2 mm
a 2.2 mm



bis 6 mm
up to 6 mm
hasta 6 mm
a 6 mm

34559-47 TC 47 cm, 18 1/2"



bis 6.5 mm
up to 6.5 mm
hasta 6.5 mm
a 6.5 mm

34560-57 TC 57 cm 22 1/2"

Drahtkneifzange
Wire Cutter
Alicate para alambre
Tronchese tagliafilii

**HERCULES****34547-23 TC 23 cm / 9"**

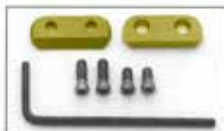
für Bohrdrähte bis max. 3 mm Ø
über 40% Kraftersparnis durch Spezialmechanik
auswechselbare Hartmetallschneiden
auswechselbare Gummibacken
komplett sterilisierbar

for drill wires of max 3 mm Ø
over 40% less power required by special mechanic
exchangeable TC-blades
exchangeable rubber jaws
full sterilisable

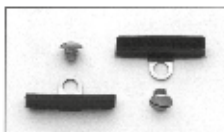
para taladros filiformes de max. 3 mm Ø
reducción de la fuerza manual en más de un 40%
placas de tungsteno intercambiables
bocas de goma intercambiables
complemente esterilizable

con riduzione di forza più del 40%
Per fili perforatori fino a 3 mm
Placche taglienti al TC intercambiabili
Ganasce in gomma intercambiabili
Completamente sterilizzabili

Ersatzteilsets
Spare Part Sets
Juegos de recambios
Set per parti di ricambio

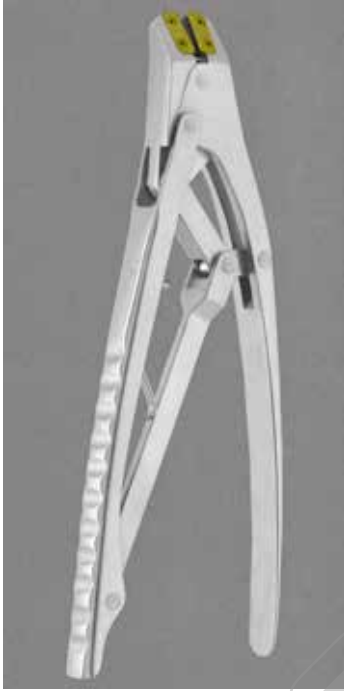


34547-01
1 Paar Hartmetallschneiden / 2 Paar Schrauben / 1 Inbusschlüssel
1 pair of TC-blades / 2 pairs of screws / 1 Allen key
1 par de placas de tungsteno / 2 pares de tornillos / 1 llave hexagonal
1 Paio di placche TC / 2 Paio di viti da fissaggio / 1 chiave esagonale



34547-03
1 Paar Gummibacken / 1 Paar Schrauben
1 pair of rubber jaws / 1 pair of screws
1 par de bocas de goma / 1 par de tornillos
1 Paio ganasce in gomma / 1 Paio di viti da fissaggio

Drahtkneifzange
Wire Cutter
Alicate para alambre
Tronchese tagliafili

**HERCULES****34547-28 TC 28 cm / 11"**

für Bohrdrähte ab 2,5 - 4,0 mm
über 40% Kraftersparnis durch Spezialmechanik
auswechselbare Hartmetallschneiden
auswechselbare Gummibacken
komplett sterilisierbar

for drill wires of 2.5 - 4.0 mm
over 40% less power required by special mechanic
exchangeable TC-blades
exchangeable rubber jaws
full sterilisable

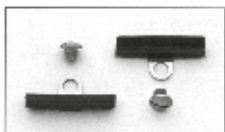
para taladros filiformes de 2,5 - 4,0 mm
reducción de la fuerza manual en más de un 40%
placas de tungsteno intercambiables
bocas de goma intercambiables
complemente esterilizable

con riduzione di forza più del 40%
Per fili perforatori fino a 2,5 - 4,0 mm
Placche taglienti al TC intercambiabili
Ganasce in gomma intercambiabili
Completamente sterilizzabili

Ersatzteilsets
Spare Part Sets
Juegos de recambios
Set per parti di ricambio

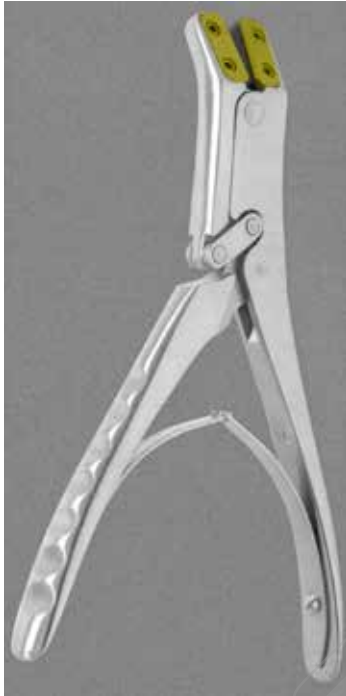
**34547-02**

1 Paar Hartmetallschneiden / 2 Paar Schrauben / 1 Inbusschlüssel
1 pair of TC-blades / 2 pairs of screws / 1 Allen key
1 par de placas de tungsteno / 2 pares de tornillos / 1 llave hexagonal
1 Paio di placche TC / 2 Paio di viti da fissaggio / 1 chiave esagonale

**34547-03**

1 Paar Gummibacken / 1 Paar Schrauben
1 pair of rubber jaws / 1 pair of screws
1 par de bocas de goma / 1 par de tornillos
1 Paio ganasce in gomma / 1 Paio di viti da fissaggio

Drahtkneifzange
Wire Cutter
Alicate para alambre
Tronchese tagliafilii

**HERCULES****35548-18 TC 18 cm / 7"**

für Bohrdrähte bis max. Ø 2,2 mm
über 40% Kraftersparnis durch Spezialmechanik, auswechselbare
Hartmetallschneiden
auswechselbare Gummibacken
komplett sterilisierbar

for drill wires of max 0 2.2 mm
over 40% less power required by special mechanic
exchangeable TC-blades
exchangeable rubber jaws
full sterilisable

para taladros filiformes de max. Ø 2,2 mm
reducción de la fuerza manual en más de un 40%
placas de tungsteno intercambiables
bocas de goma intercambiables
complemente esterilizable

con riduzione di forza più del 40%
Per fili perforatori da 2,2 mm
Utilizzabile a scelta per mano sinistra e destra
Placche taglienti al TC intercambiabili
Ganasce in gomma intercambiabili
Completamente sterilizzabili

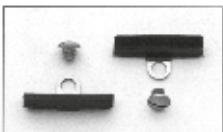
für Rechtshänder / tor right-handers /
para la mano derecha / per mano destra



Ersatzteilsets
Spare Part Sets
Juegos de recambios
Set per parti di ricambio



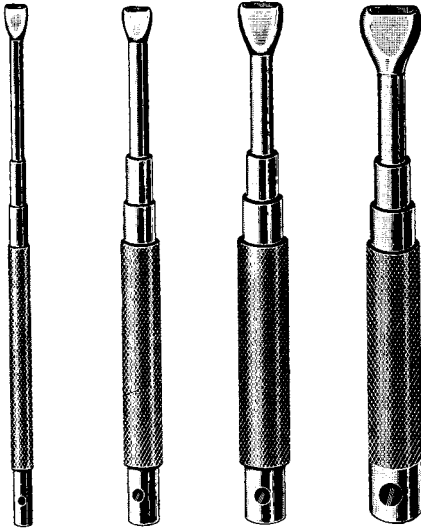
35547-01
1 Paar Hartmetallschneiden / 2 Paar Schrauben / 1 Inbusschlüssel
1 pair of TC-blades / 2 pairs of screws / 1 Allen key
1 par de placas de tungsteno / 2 pares de tornillos / 1 llave hexagonal
1 Paio di placche TC / 2 Paio di viti da fissaggio / 1 chiave esagonale



34547-03
1 Paar Gummibacken / 1 Paar Schrauben
1 pair of rubber jaws / 1 pair of screws
1 par de bocas de goma / 1 par de tornillos
1 Palo ganasce in gomma / 1 Paio di viti da fissaggio

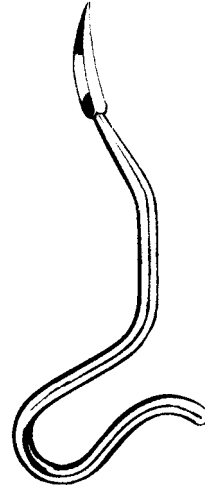


Instrumentarium für Ender und Küntscher Nägel
 Instruments for ender and Küntscher Nails
 Instrumental para Clavos Ender y Küntscher
 Strumentario per chiodi di Ender e Küntscher



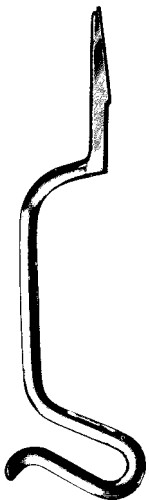
34562-24	34562-32	34562-48	34562-64
f./p. Ø 2,4 mm	3,2 mm	4,8 mm	6,4 mm

Ein- und Ausschlaginstrumente für Ender-Nägel
 Driver-extractors for Ender nails
 Impactores-Extractores para clavos de Ender
 Impattatore-Estrattore per chiodi di Ender



KÜNTSCHER	26 cm, 10 1/4"
34570-01	8 mm
34570-02	10 mm

Vorböhrer zum Öffnen der Markhöhle
 Reamers for medullary cave
 Perforadores para la cavidad medular
 Alesatore per l'apertura del midollo



KÜNTSCHER
 34573-35 35 cm, 13 3/4"
 Aufreiber für Oberschenkel
 Reamer for femur
 Perforador para fémur
 Alesatore per femore



Führungsspieße
 Guide pins
 Guía-conductora para clavos medulares
 Guida conduttrice

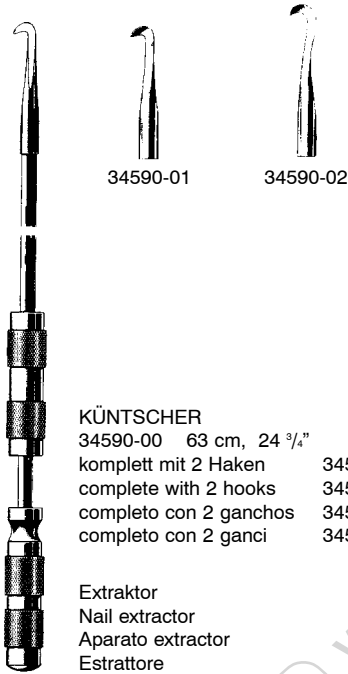
mm Ø	L = 60 cm, 23 3/4"
3,5	34583-60
4,0	34584-60
5,0	34585-60



für Nägel for nails para clavos per chiodi
Ø 6-8 mm 34588-01
Ø 9-12 mm 34588-02
Ø 12-17 mm 34588-03

KUENTSCHER 19 cm, 7 1/2"
 Fertigschläger
 Nail impactors
 Impactor final
 Impattatore finale

Instrumentarium für Küntscher Nägel
 Instruments for Küntscher Nails
 Instrumental para Clavos Küntscher
 Strumentario per chiodi di Küntscher

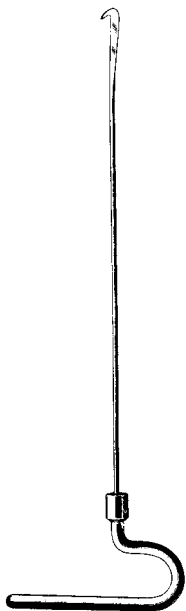


KÜNTSCHER

34590-00 63 cm, 24 3/4"

komplett mit 2 Haken	34590-01/02
complete with 2 hooks	34590-01/02
completo con 2 ganchos	34590-01/02
completo con 2 ganci	34590-01/02

Extraktor
 Nail extractor
 Aparato extractor
 Estrattore



Extraktionshaken
 Extraction hooks
 Ganchos extractores
 Gancio d'estrazione

34596-29	29 cm 11.4"
34596-37	37 cm 14.5"
34596-42	42 cm 16.5"
34596-49	49 cm 19.3"



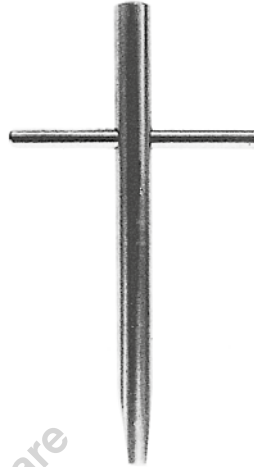
Markraumborner
 Intramedullary drills
 Perforadores medulares
 Perforatore intramidollare

Ø	
6,0 mm	34597-06
7,0 mm	34597-07
8,0 mm	34597-08
9,0 mm	34597-09
10,0 mm	34597-10
11,0 mm	34597-11
12,0 mm	34597-12
13,0 mm	34597-13
14,0 mm	34597-14
15,0 mm	34597-15
16,0 mm	34597-16
17,0 mm	34597-17
18,0 mm	34597-18
19,0 mm	34597-19
20,0 mm	34597-20

Instrumentarium für Küntscher Nägel
Instruments for Küntscher Nails
Instrumental para Clavos Küntscher
Strumentario per chiodi di Küntscher



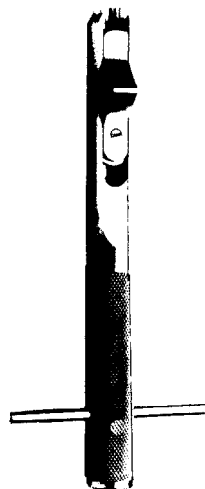
Einschläger / Nail Inserter
Introducer clavos / Impattatore
34612-00



Impactor
34613-00



BENDER
34615-00



Impactor-Extractor
Impattatore-Estrattore
34617-00



Schraubenzieher
Screw Drivers
Destornilladores
Cacciaviti

6 mm



LANE
34620-25 25 cm, 10"

3,5 mm



34624-01



34624-02



WILLIAMS
24 cm, 9 1/2"



34624-03



34624-04



mit Ferrozellgriff
with Ferrozell handle
con mango de Ferrozell
con manico di Ferrozell



34628-01
25 cm, 10"



34628-02
25 cm, 10"



34629-01
25 cm, 10"



1,5 mm

34628-15
20 cm, 8"



2,5 mm

34628-25
25 cm, 10"



3,5 mm

34628-35
25 cm, 10"

Schraubenzieher
Screw Drivers
Destornilladores
Cacciaviti

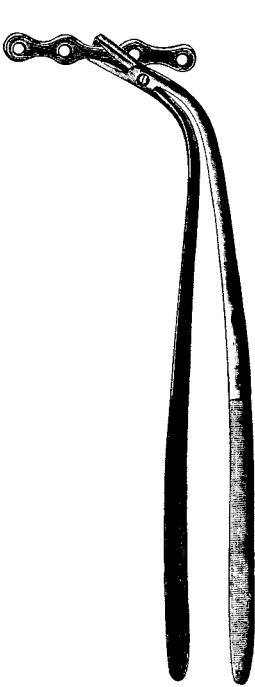


LANE
34632-25 25 cm, 10"
Kreuzschlitzschraubenzieher
Screwdriver for cross slotted head
Destornillador para tornillos con ranura en cruz
Cacciavite a croce



Schraubenhaltehülse für Sechskantschrauben
Screw holder
Vaina para tornillos
Guaina per viti esagonali
34634-35 3,5 mm

Haltezangen, Biegehebel
 Holding Forceps, Bender
 Pinzas para sostener placas y tornillos, Palanca
 Pinza portaplacca, leva piegaplacche



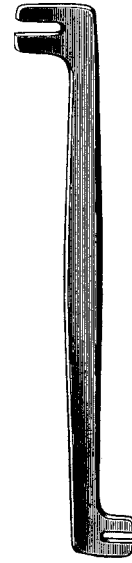
LANE
 34637-23 23 cm, 9"

Knochenplatten-Haltezange
 Plate Holding Forceps
 Pinza para sostener placas
 Pinza portaplacche



LANE
 34639-22 22 cm, 8 3/4"

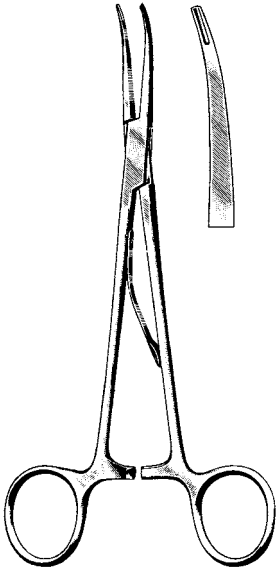
Schraubenhaltezange
 Screw Holding Forceps
 Pinza para sostener tornillos
 Pinza portaviti



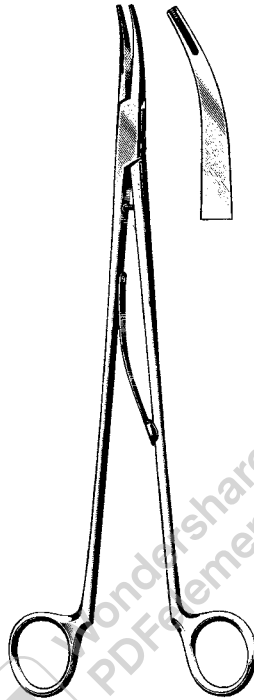
LANE
 34640-18 18 cm, 7"

Biegehebel f. Knochenplatten
 Plate Bender
 Palanca para doblar placas
 Leva piegaplacche

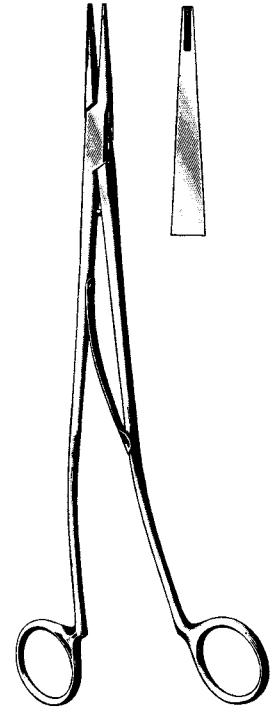
Anlegezangen, Silberklammern
 Applying Fcps. Clips
 Pinzas aplicadoras, Grapas
 Pinza per applicare, Agrafes



McKENZIE
 41011-15 15 cm, 6"
 41011-19 19 cm, 7 1/2"



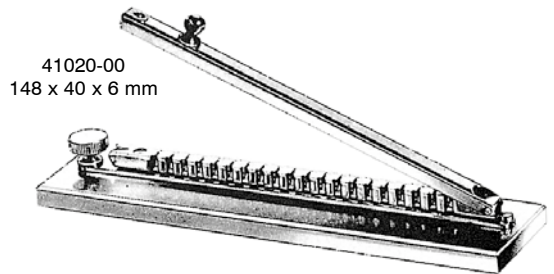
SMITHWICK
 41015-23 23 cm, 9"
 41015-26 26 cm, 10 1/4"



SWEET
 41017-23 23 cm, 9"
 41017-26 26 cm, 10 1/4"



OLIVECRONA-TOENNIS
 41019-14

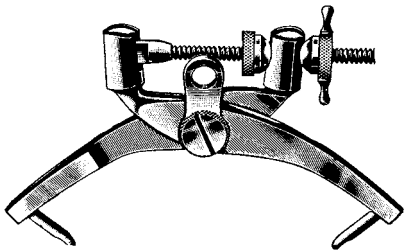


41020-00
 148 x 40 x 6 mm



41021-00
 (100 pcs.)

Schädelhalter, Kopfhautklammer, Anlegezange
 Cervical Traction Tongs, Clips, Applying Forceps
 Pinzas de tracción craneal, Clips, Pinza para aplicar clips
 Pinze per trazione craniale, Pinza per applicare



CRUTCHFIELD
41025-01



CRUTCHFIELD
41025-02



41026-35
3,5 mm Ø

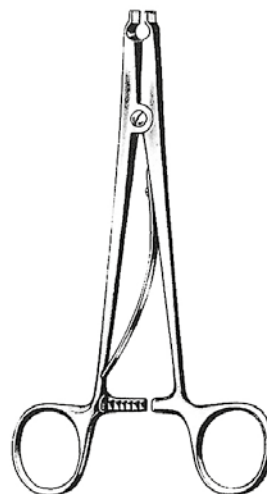


41026-50
5 mm Ø

Stainless steel
Acciaio inox



RANEY
41027-00



RANEY
41028-00 16 cm, 6 1/4"

Nervhaken, Durahaken
Nerve Hooks, Dura Hooks
Ganchos para nervios y para dura-madre
Unicini per nervi e per dura-madre



DANDY
41051-20
20 cm, 8"



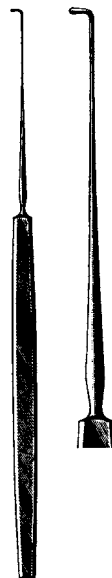
DANDY
41052-20
20 cm, 8"



DANDY
41053-20
20 cm, 8"



CRILE
41054-20
20 cm, 8"



CUSHING
41056-18 18 cm, 7"
41056-28 28 cm, 11"



CUSHING
41058-18 18 cm, 7"
41058-28 28 cm, 11"

Fig. 1

Fig. 2

Nervhaken, Durahaken
Nerve Hooks, Dura Hooks
Ganchos para nervios y para dura-madre
Unicini per nervi e per dura-madre



GRAHAM
41061-16
16,5 cm, 6 1/2"



SACHS
41064-16
18,5 cm, 7 1/4"



ADSON
41068-20
20 cm, 8"

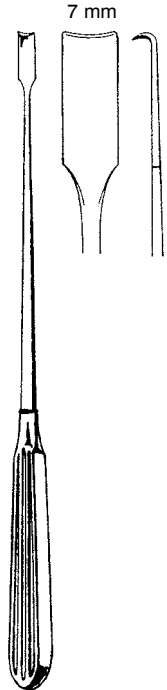


ADSON
41069-20
20 cm, 8"



SMITHWICK
41070-29
29 cm, 11.4"

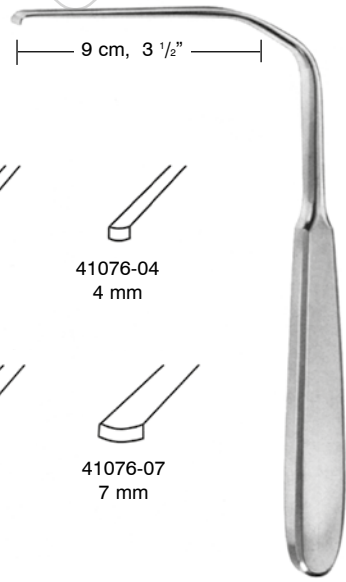
Nervwurzelnhaken
 Nerve Root Retractors
 Separadores de raiz de nervios
 Uncini per le radici dei nervi



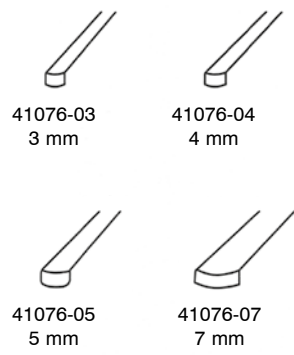
SCOVILLE
 41074-23
 23 cm, 9"



HOLSHER
 41075-24
 24 cm, 9 1/2"



HESS
 17,5 cm, 7"



Wondershare
 PDFelement

Nervwurzelnhaken
Nerve Root Retractors
Separadores de raiz de nervios
Uncini per le radici dei nervi



D'ERRICO
41078-23
23 cm, 9"



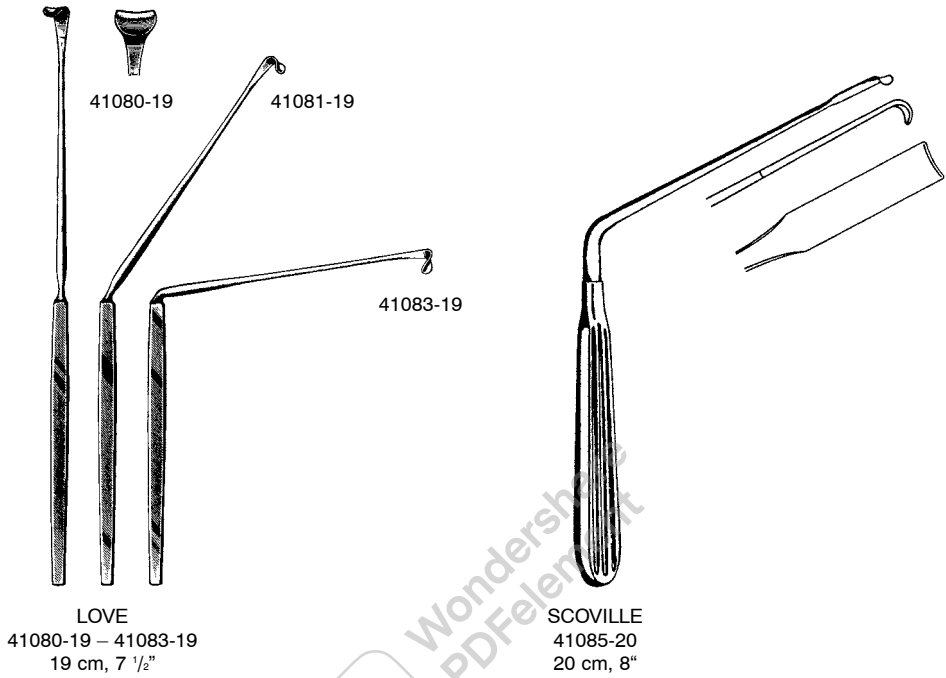
Wondershare
PDFelement



LOVE
41079-21
21 cm, 8 1/4"



Nervwurzelhaken, Galeahaken
 Nerve Root Retractors, Galea Hooks
 Separadores de raiz de nervios, Gancho para galea
 Uncini per le radici dei nervi, Uncini galea

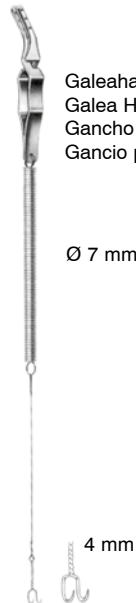


LOVE
 41080-19 – 41083-19
 19 cm, 7 1/2"

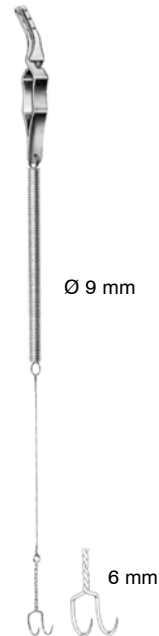
SCOVILLE
 41085-20
 20 cm, 8"



DeMARTEL
 41090-33
 33 cm, 13"



YASARGIL
 41091-31
 31 cm, 12 1/4"



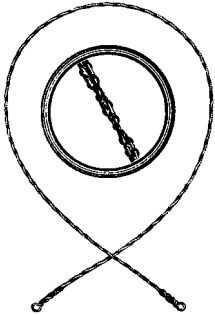
YASARGIL
 41091-41
 41 cm, 16"

Schädelstanze
Cranial Punch
Pinzas sacabocado craneal
Pinza per craniotomia

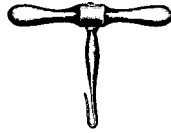


CONE
41097-22
22,5 cm 9"

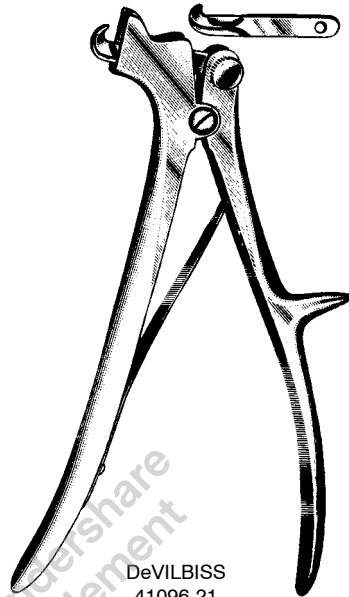
Drahtsägen, Schädelzange, Dura Dissektoren
 Wire Saws, Skull Punches, Dura Dissectors
 Sierras de hilo, Pinzas sacabocado craneal, Elevadores para la duramadre
 Fili sega, Pinza per craniotomia, Scollatori per duramadre



OLIVECRONA	cm
41092-30	30, 11 3/4"
41092-40	40, 15 3/4"
41092-50	50, 19 3/4"
41092-60	60, 23 3/4"
41092-70	70, 27 1/2"



GIGLI
 41094-00
 Drahtsägen-Handgriff
 Wire Saw Handle
 Mango de gancho
 Manico con uncino



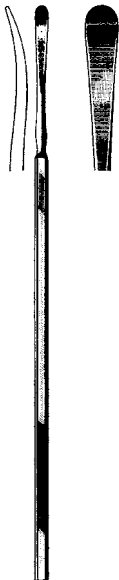
DeVILBISS
 41096-21
 21 cm, 8 1/4"



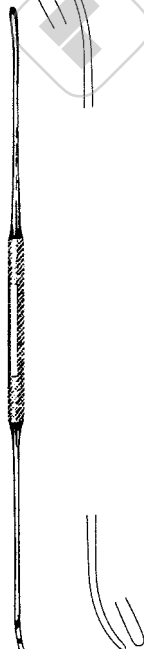
TOENNIS
 41141-25
 25 cm, 10"



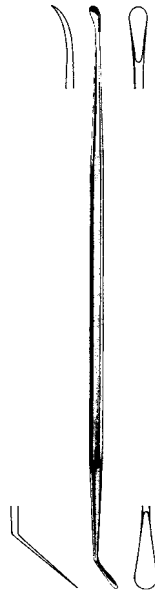
SACHS
 41143-21
 21 cm, 8 1/4"



SACHS
 41145-21
 21 cm, 8 1/4"



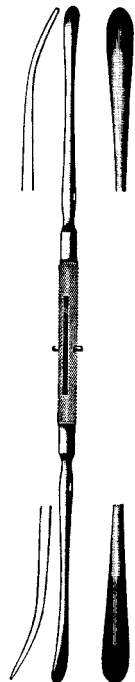
OLIVECRONA
 41146-18 18 cm, 7"
 41146-24 24 cm, 9 1/2"



MILLIGAN
 41147-21
 21 cm, 8 1/4"

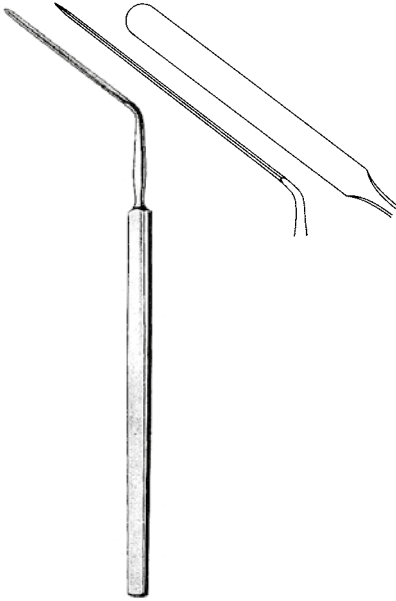


41149-22
 22 cm, 8 3/4"



DAVIS
 41151-24
 24 cm, 9 1/2"

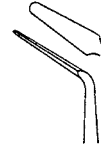
Dura Dissektoren
Dura Dissectors
Elevadores
Scollatori



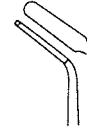
HORSLEY
41155-20
20 cm, 8"



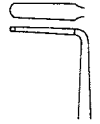
WOODSON
41156-18
18 cm, 7"



FRAZIER
41158-01
15 cm, 6"



HOEN
41158-02
15 cm, 6"



HOEN
41158-03
15 cm, 6"



PENFIELD
41161-01
17,5 cm, 6.9"



PENFIELD
41161-02
19,5 cm, 7 3/4"



PENFIELD
41161-03
19,5 cm, 7 3/4"



PENFIELD
41161-04
21,5 cm, 8 1/2"



PENFIELD
41161-05
29 cm 11.4"

Hypophyse Pinzetten, Küretten
Hypophyseal Forceps, Curette
Pinzas para hipófisis, Curetas
Pinze per ipofisi, Curette



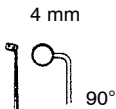
ADSON
41210-23
23 cm, 9"



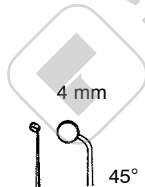
ADSON
41211-23
23 cm, 9"



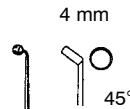
ADSON
41213-23
23 cm, 9"



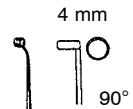
RAY
41221-00
19 cm, 7 1/2"



RAY
41222-00
19 cm, 7 1/2"

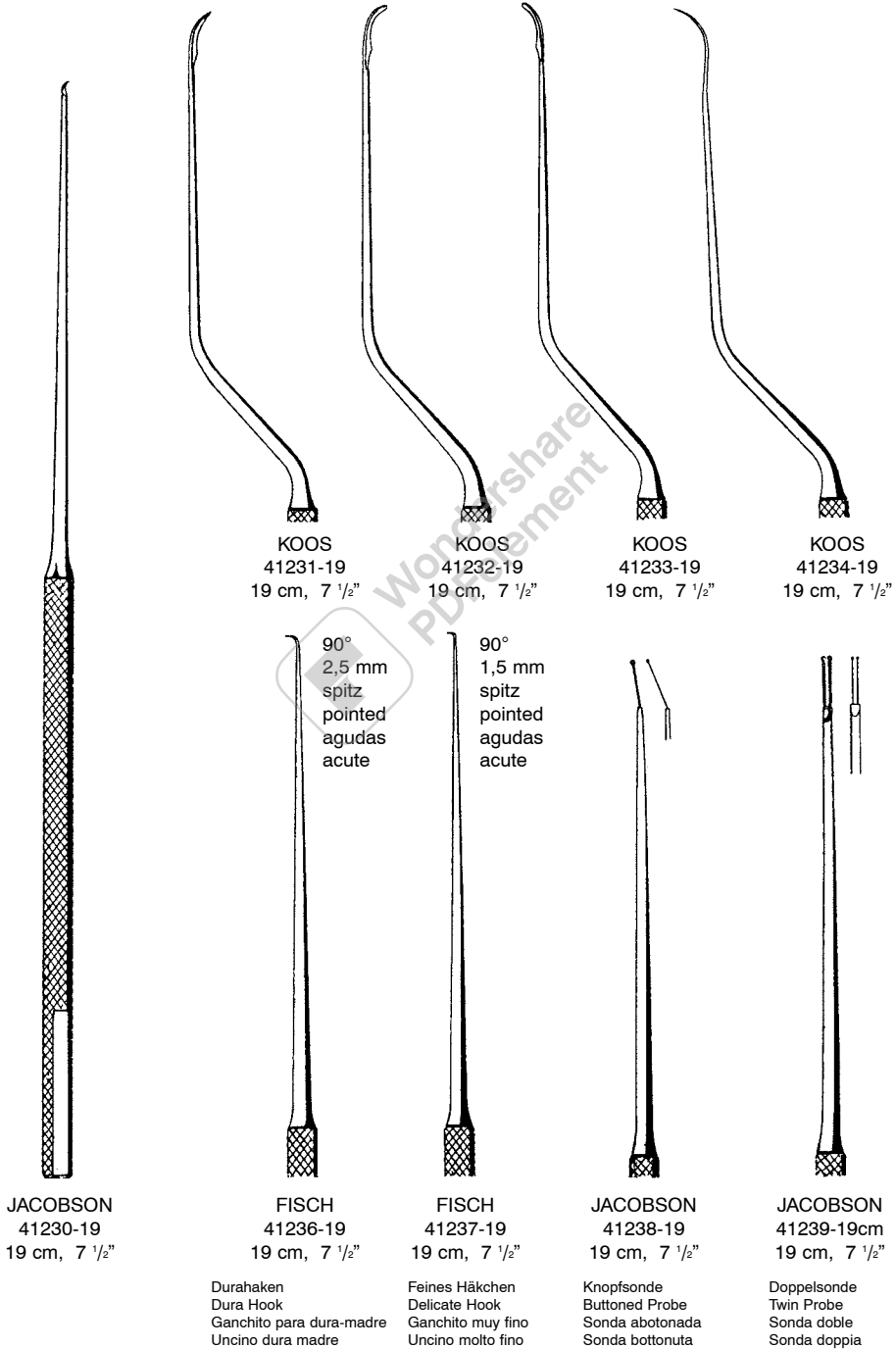


RAY
41223-00
19 cm, 7 1/2"



RAY
41224-00
19 cm, 7 1/2"

Gefäß-Messer, Haken, Sonden
Vessel-Knives, Hooks, Probes
Bisturies, Ganchos, Sondas
Bisturi, Uncino, Sonde



Nervhäkchen, Hirnspatel, Saugrohre
 Nerve Hooks, Brain Spatulas, Suction Tubes
 Ganchos para nervios, Espatulas cerebrales, Tubos de aspiración
 Uncini per nervi, Spatole cerebrali, Tubi aspirazioni



KRAYENBÜHL
 41242-19
 19 cm, 7 1/2"



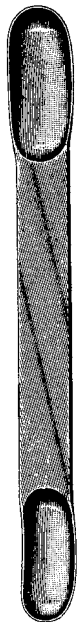
KRAYENBÜHL
 41243-19
 19 cm, 7 1/2"



KRAYENBÜHL
 41244-19
 19 cm, 7 1/2"



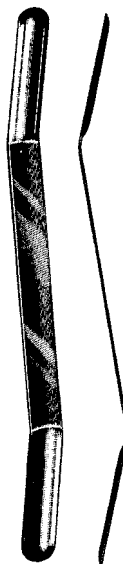
KRAYENBÜHL
 41245-19
 19 cm, 7 1/2"



CUSHING
 18 cm, 7"

41250-11 8x10 mm
 41250-15 13x15 mm
 41250-18 16x18 mm

konkav
 concave
 cóncavo
 concavi



OLIVECRONA

18 cm, 7" mm
 41253-07 7/ 9
 41253-11 11/13
 41253-15 15/18
 41253-18 18/22



BARON

41299-03 3FR 1,0 mm
 41299-05 5FR 1,6 mm
 41299-07 7FR 2,3 mm

Hirnspatel, Saugrohre, Punktionskanüle
Brain Spatulas, Suction Tubes, Puncture Cannulas
Espatulas cerebrales, Tubos de aspiración, Tubo de punción
Spatole cerebrali, Tubi aspirazioni, cannula per punzione



biegsam
malleable
maleable
malleabile

DAVIS 18 cm, 7"

41254-06	6 mm, 1/4"
41254-10	9 mm, 3/8"
41254-13	13 mm, 1/2"
41254-16	16 mm, 5/8"
41254-19	19 mm, 3/4"
41254-25	25 mm, 1"
41254-32	32 mm, 1 1/4"
41254-38	38 mm, 1 1/2"



ADSON

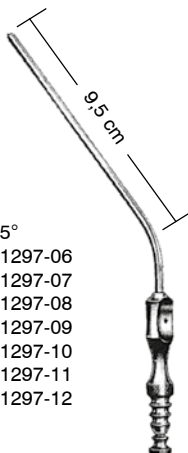
41290-21
21 cm, 8 1/4"
ø 4 mm



isoliert
isolated
isolada
isolato

FERGUSON

41294-40
18 cm, 7"
ø 4 mm, 90°



Charr.

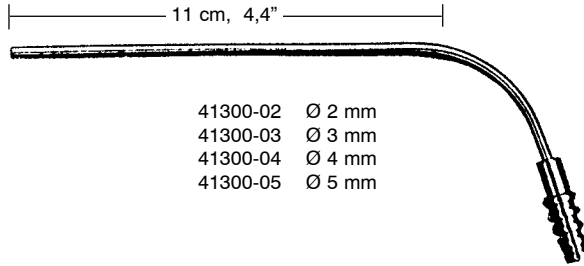
F.G.	30°	75°
6	41295-06	41297-06
7	41295-07	41297-07
8	41295-08	41297-08
9	41295-09	41297-09
10	41295-10	41297-10
11	41295-11	41297-11
12	41295-12	41297-12
15	41295-15	

FRAZIER / FERGUSON
41295-06 – 41297-12
19 cm, 7 1/2"

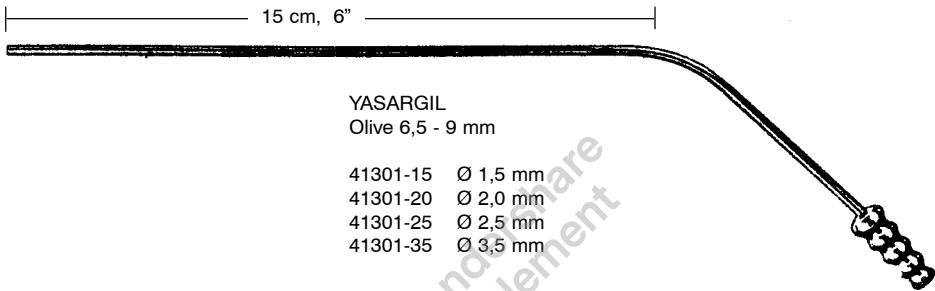


FRAZIER / FERGUSON
41298-12
12 cm, 4 3/4" / 3 mm

Saugrohre
Suction Tubes
Tubos de aspiración
Tubi aspirazioni



41300-02 Ø 2 mm
41300-03 Ø 3 mm
41300-04 Ø 4 mm
41300-05 Ø 5 mm



YASARGIL
Olive 6,5 - 9 mm

41301-15 Ø 1,5 mm
41301-20 Ø 2,0 mm
41301-25 Ø 2,5 mm
41301-35 Ø 3,5 mm



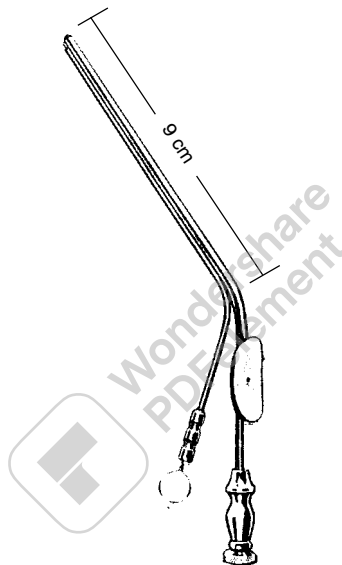
ZÖLLNER
41302-02



0,5 mm Ø 41306-05
0,7 mm Ø 41306-07
0,9 mm Ø 41306-09
1,2 mm Ø 41306-12

Kanüle für Sauggriff für ZÖLLNER und WULLSTEIN
Tip for Suction Handle for ZÖLLNER and WULLSTEIN
Cánula para mango t ZÖLLNER y WULLSTEIN
Cannula per manico di aspirazione t ZÖLLNER e WULLSTEIN

Saugrohre
Suction Tubes
Tubos de aspiración
Tubi aspirazioni



HOUSE

9 cm, 3 1/2"

41303-09	Ø 0,9 x 0,7 mm
41303-12	Ø 1,2 x 0,9 mm
41303-15	Ø 1,5 x 1,2 mm
41303-18	Ø 1,8 x 1,8 mm
41303-25	Ø 2,5 x 2,0 mm
41303-30	Ø 3,0 x 2,0 mm
41303-45	Ø 4,5 x 2,0 mm

Saugrohre, Saugkanülen
 Suction Tubes, Suction Cannulae
 Tubos de aspiración, Cánulas para aspiración
 Tubi aspirazioni, Cannule per aspirazione



Sauggriff
 Suction Handle
 Mango de aspiración
 Manico per aspirazione

WULLSTEIN
 41307-00



Kanüle für Sauggriff
 Tip for Suction Handle
 Cánula para mango
 Cannula per manico di aspirazione

ROSEN
 10 cm, 4"

0,5 mm Ø	41305-05	1,2 mm Ø	41305-12
0,6 mm Ø	41305-06	1,5 mm Ø	41305-15
0,7 mm Ø	41305-07	1,8 mm Ø	41305-18
0,8 mm Ø	41305-08	2,0 mm Ø	41305-20
0,9 mm Ø	41305-09	2,5 mm Ø	41305-25
1,0 mm Ø	41305-10	3,0 mm Ø	41305-30



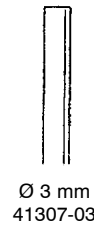
Charr. 6 41304-06
 Charr. 8 41304-08
 Charr. 10 41304-10

PLESTER
 30°



biegsam
 malleable
 malleable
 malleabile

SCHMID
 15 cm, 6"



Ø 3 mm
 41307-03



Ø 4 mm
 41307-04

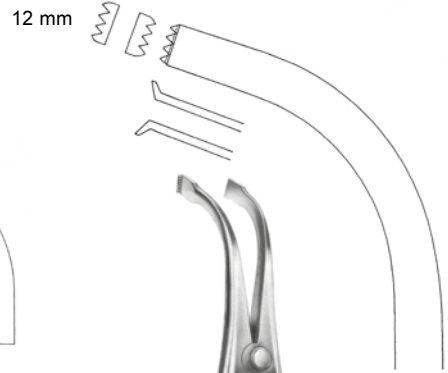


Ø 5 mm
 41307-05



Ø 6 mm
 41307-06

Wirbelkörperspreizer
Lamina Spreaders
Separadores para cuerpos vertebrales
Divaricatori per corpi vertebrali



CLOWARD
41401-16
16 cm, 6 1/4"



INGE
41405-17
17 cm, 6 3/4"

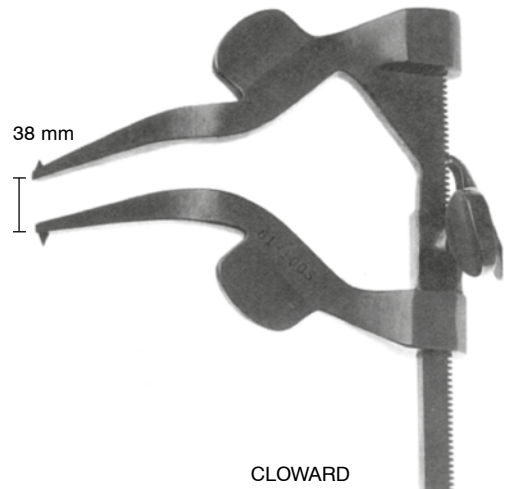


INGE
41405-27
27 cm, 10 1/2"



19 mm

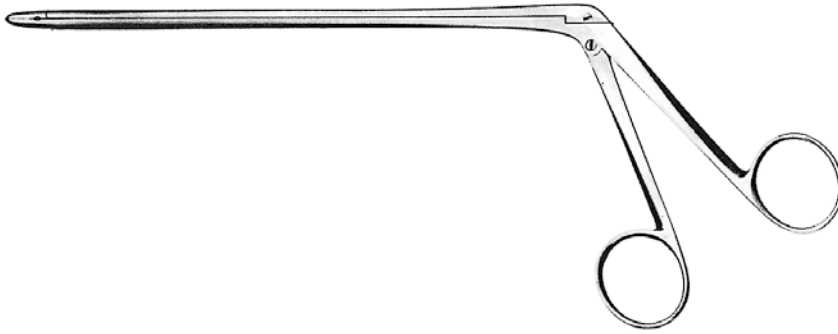
CLOWARD
41406-01
12,5 cm, 5"



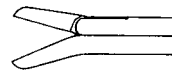
38 mm

CLOWARD
41406-02
7,6 cm, 3"

Laminektomie Zangen
 Laminectomy Rongeurs
 Pinzas cortantes para laminectomia
 Pinze taglienti per laminectomia

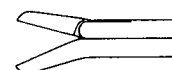
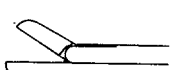


CUSHING
2 mm



2x10 mm	L	2x10 mm/45°	L	2x10 mm/45°	L
41420-01	12,5 cm	41420-02	12,5 cm	41420-03	12,5 cm
41421-01	15,0 cm	41421-02	15,0 cm	41421-03	15,0 cm
41422-01	18,0 cm	41422-02	18,0 cm	41422-03	18,0 cm

LOVE-GRUENWALD
3 mm



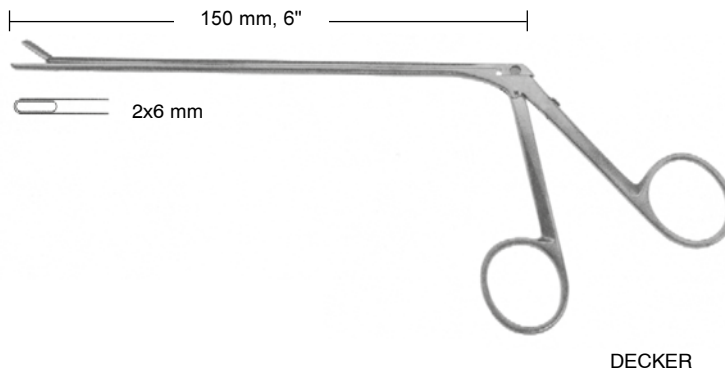
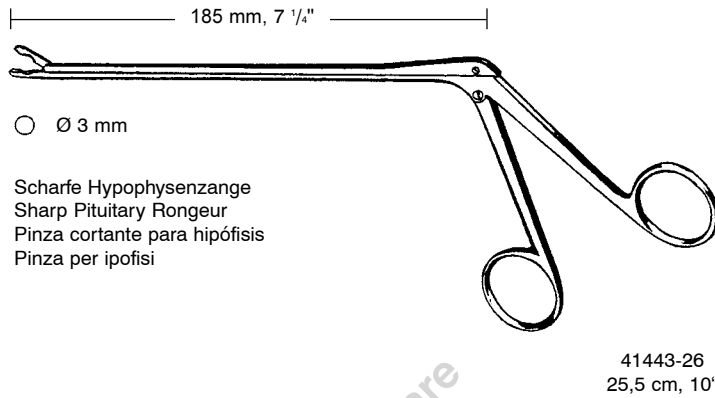
3x10 mm	L	3x10 mm/45°	L	3x10 mm/45°	L
41430-01	12,5 cm	41430-02	12,5 cm	41430-03	12,5 cm
41431-01	15,0 cm	41431-02	15,0 cm	41431-03	15,0 cm
41432-01	18,0 cm	41432-02	18,0 cm	41432-03	18,0 cm

SPURLING
4 mm

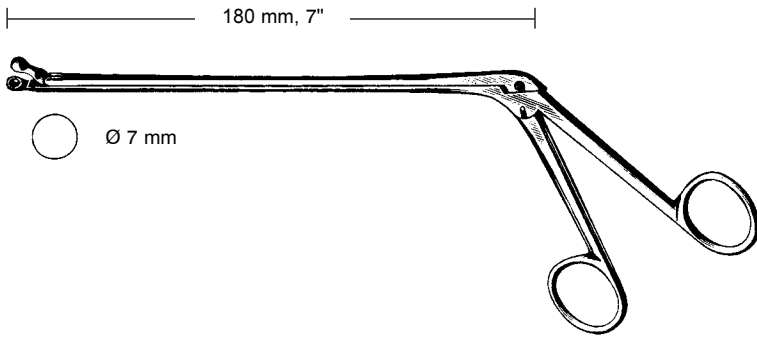


4x10 mm	L	4x10 mm/45°	L	4x10 mm/45°	L
41440-01	12,5 cm	41440-02	12,5 cm	41440-03	12,5 cm
41441-01	15,0 cm	41441-02	15,0 cm	41441-03	15,0 cm
41442-01	18,0 cm	41442-02	18,0 cm	41442-03	18,0 cm

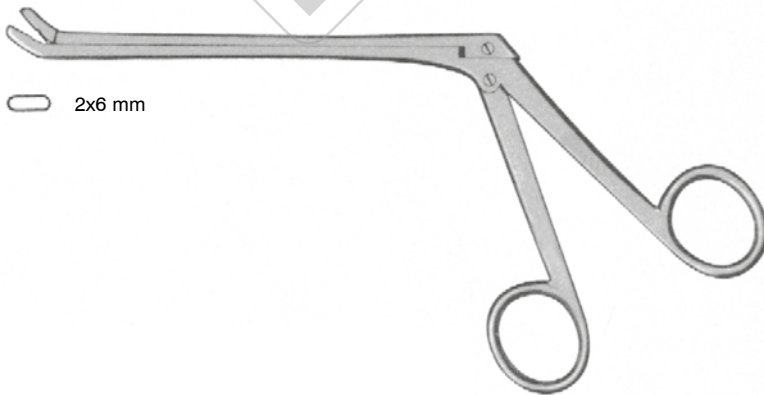
Laminektomie Zangen
Laminectomy Rongeurs
Pinzas cortantes para laminectomia
Pinze taglienti per laminectomia



Laminektomie Zangen
Laminectomy Rongeurs
Pinzas cortantes para laminectomia
Pinze taglianti per laminectomia

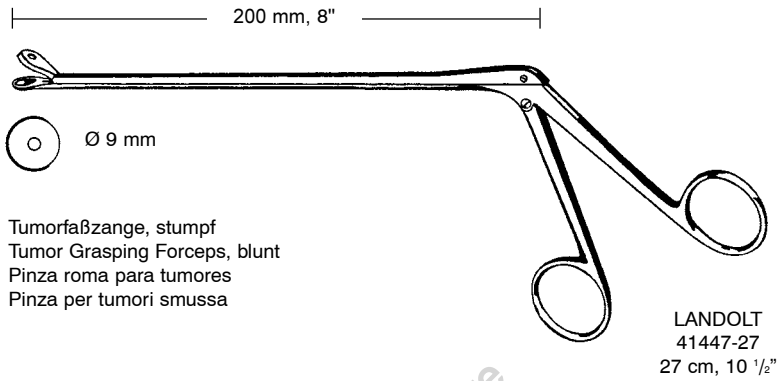


OLDBERG
41445-25
25 cm, 9.8"



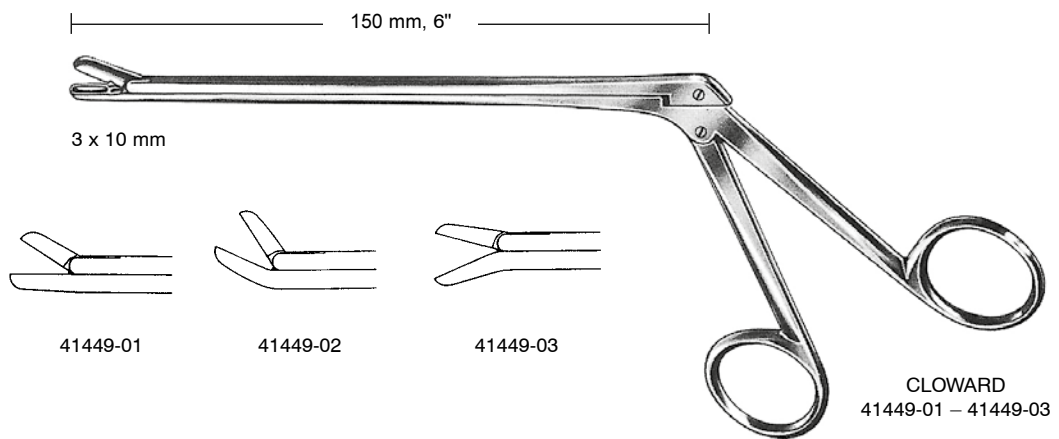
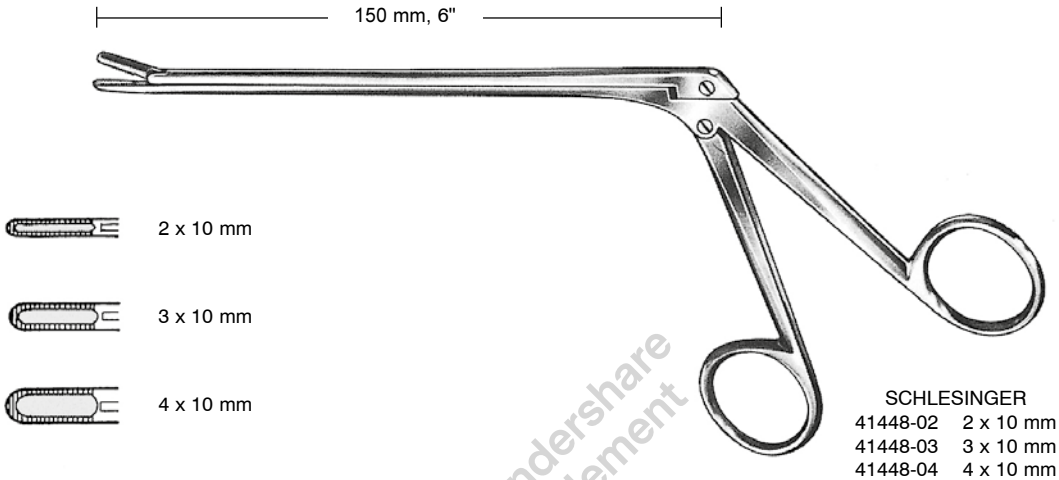
PEAPOD
41446-00

Laminektomie Zangen
Laminectomy Rongeurs
Pinzas cortantes para laminectomia
Pinze taglienti per laminectomia

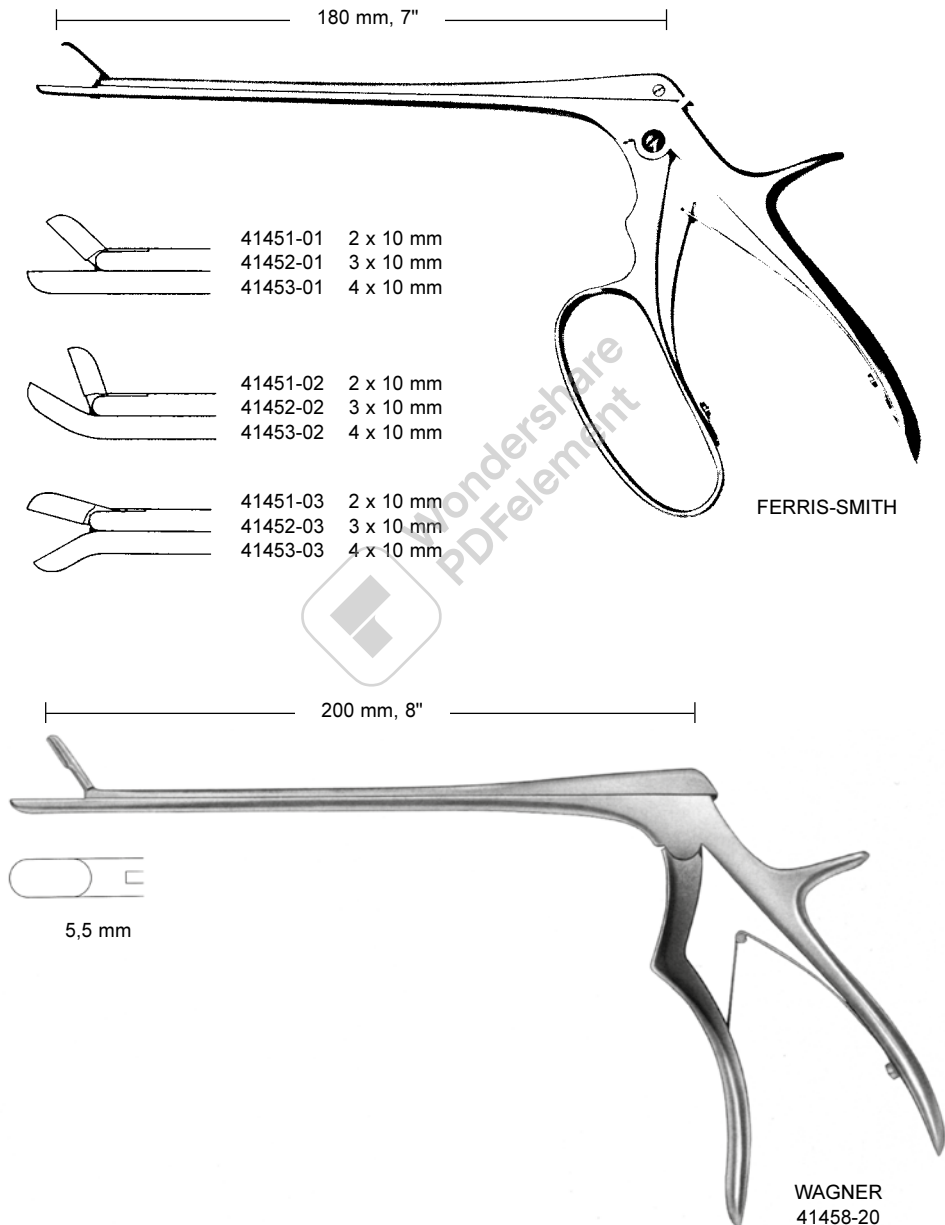


Wondershare
PDFelement

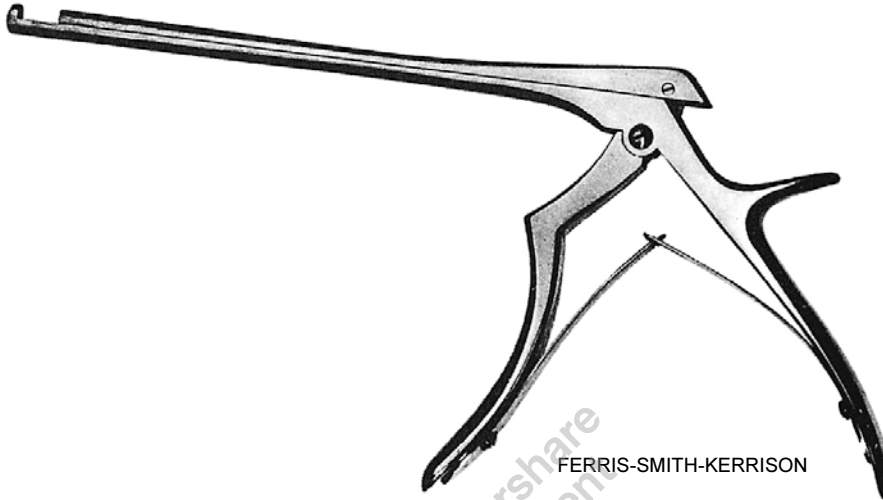
Laminektomie Zangen
 Laminectomy Rongeurs
 Pinzas cortantes para laminectomia
 Pinze taglienti per laminectomia

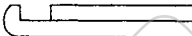
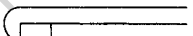
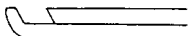
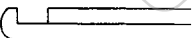
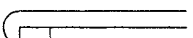
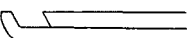
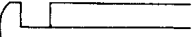
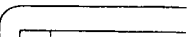

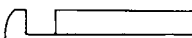
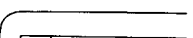
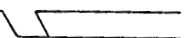

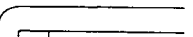
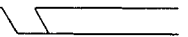


Laminektomie Zangen
Laminectomy Rongeurs
Pinzas cortantes para laminectomia
Pinze taglienti per laminectomia



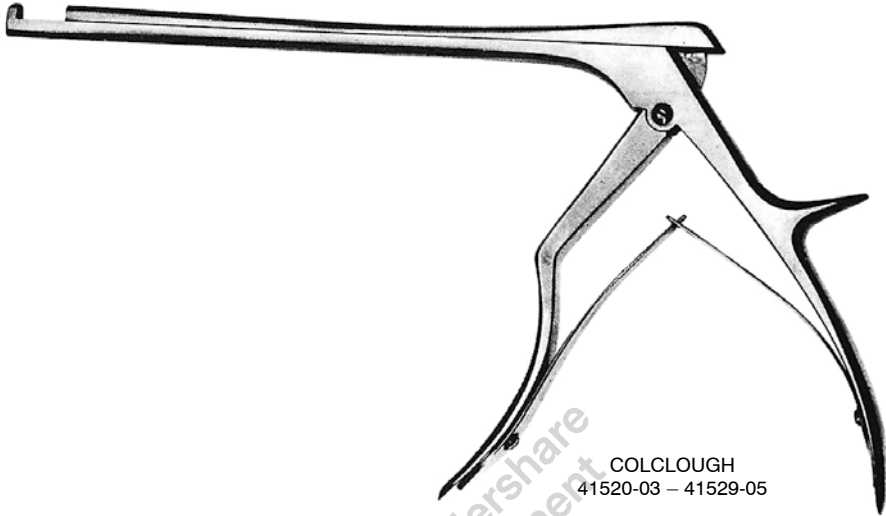
Bandscheibenstanzen
Intervertebral Disc Rongeurs
Pinzas sacabocado para discos intervertebrales
Pinze taglienti per dischi intervertebrali



	90°	90°	40°
18 cm, 7" 20 cm, 8"	 41510-01 1 mm 41513-01 1 mm	 41511-01 1 mm 41514-01 1 mm	 41512-01 1 mm 41515-01 1 mm
18 cm, 7" 20 cm, 8"	 41510-02 2 mm 41513-02 2 mm	 41511-02 2 mm 41514-02 2 mm	 41512-02 2 mm 41515-02 2 mm
18 cm, 7" 20 cm, 8"	 41510-03 3 mm 41513-03 3 mm	 41511-03 3 mm 41514-03 3 mm	 41512-03 3 mm 41515-03 3 mm
18 cm, 7" 20 cm, 8"	 41510-04 4 mm 41513-04 4 mm	 41511-04 4 mm 41514-04 4 mm	 41512-04 4 mm 41515-04 4 mm
18 cm, 7" 20 cm, 8"	 41510-05 5 mm 41513-05 5 mm	 41511-05 5 mm 41514-05 5 mm	 41512-05 5 mm 41515-05 5 mm

auch lieferbar mit Dünfuß
also available with thin foot plate
tambien disponible con lámina de punzonar estrecha
anche disponibile con morso sottile

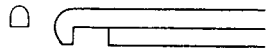
Bandscheibenstanzen
 Intervertebral Disc Rongeurs
 Pinzas sacabocado para discos intervertebrales
 Pinze taglianti per dischi intervertebrali



3 mm
 41520-03 15 cm, 6"
 41522-03 20 cm, 8"



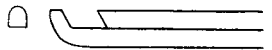
5 mm
 41520-05 15 cm, 6"
 41522-05 20 cm, 8"



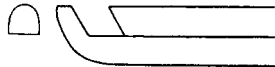
3 mm
 41524-03 15 cm, 6"
 41526-03 20 cm, 8"



5 mm
 41524-05 15 cm, 6"
 41526-05 20 cm, 8"

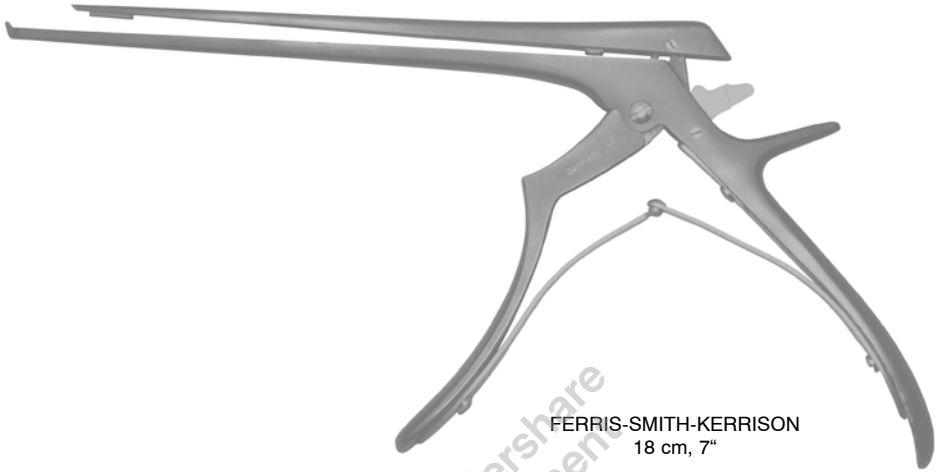


3 mm
 41527-03 15 cm, 6"
 41529-03 20 cm, 8"



5 mm
 41527-05 15 cm, 6"
 41529-05 20 cm, 8"

Zerlegbare Stanzen
 Detachable punches
 Pinzas cortantes desmontables
 Pinze taglienti e smontabili



90°



41540-02 2 mm

41540-03 3 mm

41540-04 4 mm

41540-05 5 mm

130°



41542-02 2 mm

41542-03 3 mm

41542-04 4 mm

41542-05 5 mm

YASARGIL – Aneurysmen – Gefäß – Clips
 YASARGIL – Aneurysm – Vessel – Clips
 YASARGIL – Clips para aneurisma
 YASARGIL – Clips per aneurisma

aus hochwertigem Implantat-Stahl antimagnetisch
 in high quality Implant steel antimagnetic
 de acero inoxidable para implantes de alta calidad, antimagnético
 Prodotto in acciaio di alta qualità, antimagnetico

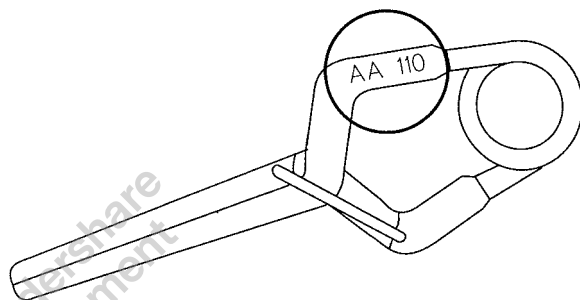
Features of the Clip

SERIAL-NUMBER

Each clip is coded with an individual serial number – marked by laser technology –
 The serial number guarantees a detailed follow-up of

- the whole production process
- the closure force
- from raw material to the final product

These informations are registered in our company for the period of 10 years.



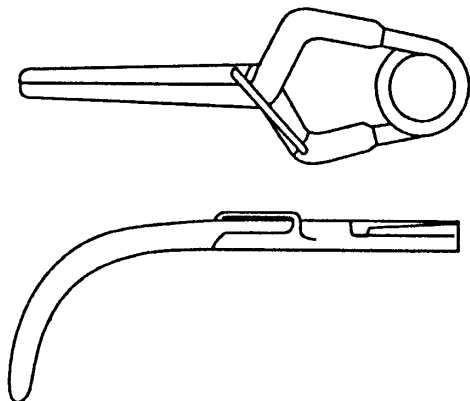
PACKING – LABELING

Each clip is individually packaged in a transparent box made of resistant plastic.
 Special wishes of customers regarding the packaging will be considered by us. This will be marked on an internal instruction.

The transparent box is marked with a label in order to assure a quick and sure identification of the clip.

On the label you can find the following data:

- catalogue number
- Product description
- Illustration
- Closing force in g
- Tolerance range of closing force
- Blade length
- Maximum opening
- Blade geometry
- Serial number
- Jaw profile
- Material description
- Lot number
- the notes "NOT STERILE"
- WARNING



YASARGIL – Aneurysmen – Gefäß – Clips

YASARGIL – Aneurysm – Vessel – Clips

YASARGIL – Clips para aneurisma

YASARGIL – Clips per aneurisma

aus hochwertigem Implantat-Stahl antimagnetisch
in high quality Implant steel antimagnetic
de acero inoxidable para implantes de alta calidad, antimagnético
Prodotto in acciaio di alta qualità, antimagnetico

Features of the Clip

JAW-PROFILE

The rounded, pyramid-like structure is stamped into the jaw through a special step in production and prevents sharp edged which could perforate an aneurysm

No edges or burrs through additional rounding of structures that border the clip outer side because of this, real atraumatic application of the clip

Increased surface area due to the pyramid-like design of the jaws inner surface the cross-like structure of the inner jaws pyramid surface doubles the tissue-holding area.

The applied pressure distributes itself evenly over the length of the jaw.

The convex closure of the clip assures an atraumatic and secure closure of the aneurysm.

Sliding of the clip is prevented.

SPRING-DESIGN

The spring size, wich is different in the Standard and Mini clips, ist the same within the same type of the Clip.

Through this, the highest degree of a secure fit is ensured by the clip applicator (clip/clip applicator fit)

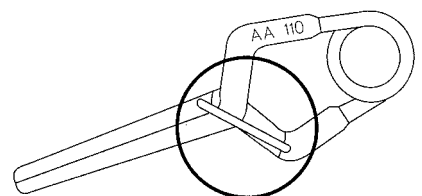
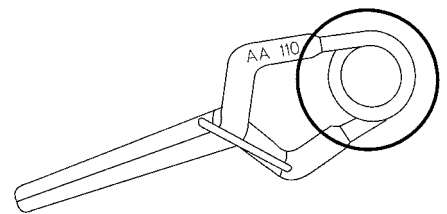
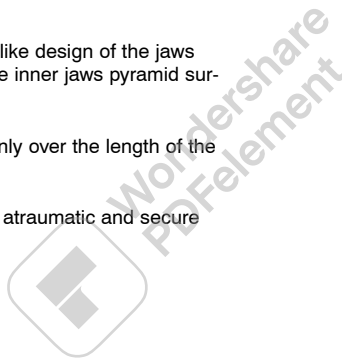
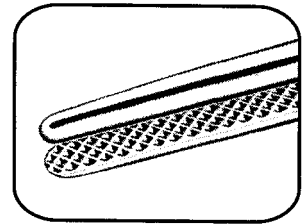
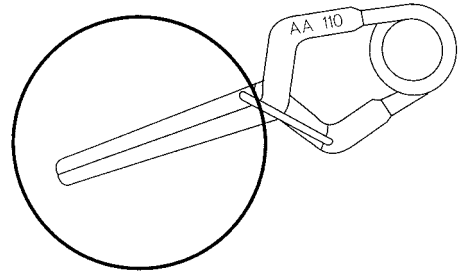
LINK-DESIGN

Laser welded

The link ensures the precise guidance of the jaws and a "soft" opening of the clip during the whole spreading process.

The contact surface of the jaws are guided symmetrically in an exact way "over the whole lenght" this fact guarantees an additional stability of the clip.

No over-stress of the material because the design of the link limits the maximum opening width.



YASARGIL – Aneurysmen – Gefäß – Clips
 YASARGIL – Aneurysm – Vessel – Clips
 YASARGIL – Clips para aneurisma
 YASARGIL – Clips per aneurisma

aus hochwertigem Implantat-Stahl antimagnetisch
 in high quality Implant steel antimagnetic
 de acero inoxidable para implantes de alta calidad, antimagnético
 Prodotto in acciaio di alta qualità, antimagnetico

Features of the Clip

CLOSING-FORCE

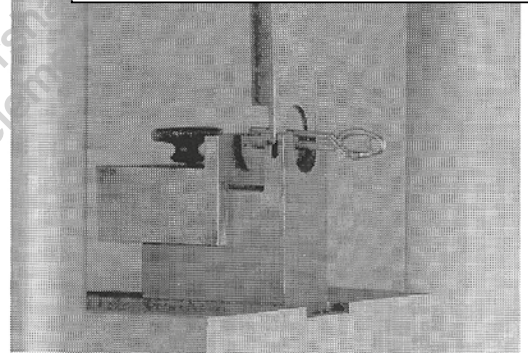
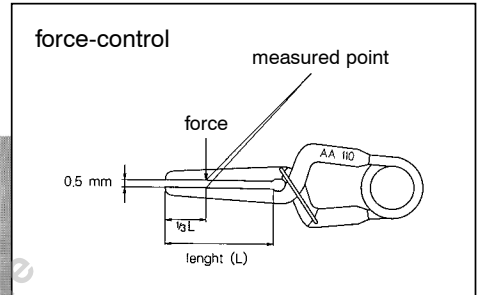
The closing force is measured at one third of the jaw length and an opening of 0,5 mm.

The final quality control of the clip is effected by a microprocessor-controlled measuring equipment.

The closing force is indicated exactly within a certain tolerance.

By the help of a special software program we assure that before the clip passes the final quality control its closure force is fixed. As a consequence we exclude any kind of manipulation.

All relevant technical data are stored during the control procedure and printed on the label.



Material and Quality Assurance

According to DIN 17445, implant steel is used in the production of our Aneurysm Clip

High stability characteristics
 Excellent tissue compatibility
 Secure closure of blood vessels
 Antimagnetic
 Ideally suited as implantation material
 Security against over straining



YASARGIL – Aneurysmen – Gefäß – Clips
 YASARGIL – Aneurysm – Vessel – Clips
 YASARGIL – Clips para aneurisma
 YASARGIL – Clips per aneurisma

aus hochwertigem Implantat-Stahl antimagnetisch
 in high quality Implant steel antimagnetic
 de acero inoxidable para implantes de alta calidad, antimagnético
 Prodotto in acciaio di alta qualità, antimagnetico

YASARGIL-STANDARD für permanenten Verschluss
 YASARGIL-STANDARD for permanent closure
 YASARGIL-STANDARD para cierre permanente
 YASARGIL-STANDARD con chiusura permanente

Standard

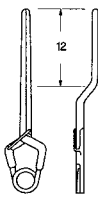
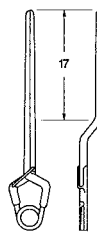
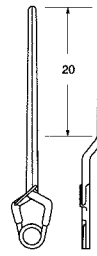
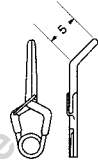
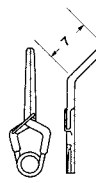
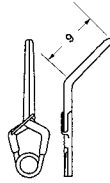
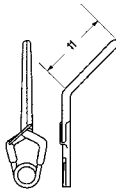
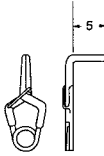
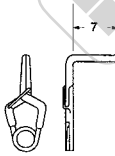
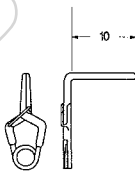
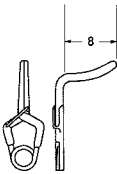
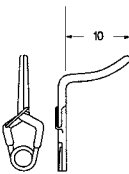
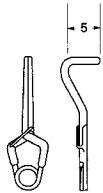
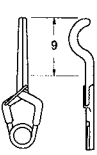
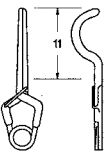
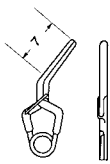
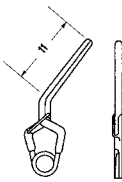
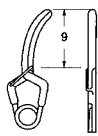
Cat. Nr.	41600-62	41600-70	41600-78	41600-92	41601-10	41601-11	
	41600-62 T	41600-70 T	41600-78 T	41600-92 T	41601-10 T	41601-11 T	
max. opening Force	6,2 mm 150 gms	7,0 mm 180 gms	7,8 mm 180 gms	9,2 mm 200 gms	10,6 mm 200 gms	11,4 mm 200 gms	
	41601-13	41602-60	41602-68	41602-75	41602-87	41603-55	41603-61
	41601-13 T	41602-60 T	41602-68 T	41602-75 T	41602-87 T	41603-55 T	41603-61 T
	13,3 mm 200 gms	6,0 mm 150 gms	6,8 mm 180 gms	7,5 mm 180 gms	8,7 mm 200 gms	5,5 mm 150 gms	6,1 mm 180 gms
	41603-65	41603-74	41604-54	41604-58	41604-62	41604-79	41604-87
	41603-65 T	41603-74 T	41604-54 T	41604-58 T	41604-62 T	41604-79 T	41604-87 T
	6,5 mm 180 gms	7,4 mm 200 gms	5,4 mm 180 gms	5,8 mm 180 gms	6,2 mm 180 gms	7,9 mm 200 gms	8,7 mm 200 gms

YASARGIL – Aneurysmen – Gefäß – Clips
 YASARGIL – Aneurysm – Vessel – Clips
 YASARGIL – Clips para aneurisma
 YASARGIL – Clips per aneurisma

aus hochwertigem Implantat-Stahl antimagnetisch
 in high quality Implant steel antimagnetic
 de acero inoxidable para implantes de alta calidad, antimagnético
 Prodotto in acciaio di alta qualità, antimagnetico

YASARGIL-STANDARD für permanenten Verschluss
 YASARGIL-STANDARD for permanent closure
 YASARGIL-STANDARD para cierre permanente
 YASARGIL-STANDARD con chiusura permanente

Standard

							
Cat. Nr.	41605-10	41605-12	41605-13	41606-62	41606-65	41606-78	
	41605-10 T	41605-12 T	41605-13 T	41606-62 T	41606-65 T	41606-78 T	
max. opening	10,2 mm	11,9 mm	13,0 mm	6,2 mm	6,5 mm	7,8 mm	
Force	200 gms	180 gms	180 gms	200 gms	200 gms	200 gms	
							
	41606-84	41607-56	41607-57	41607-58	41607-59	41607-60	41607-72
	41606-84 T	41607-56 T	41607-57 T	41607-58 T	41607-59 T	41607-60 T	41607-72 T
	8,4 mm	5,6 mm	5,6 mm	5,6 mm	5,4 mm	5,6 mm	7,2 mm
	200 gms	200 gms	200 gms	200 gms	200 gms	200 gms	200 gms
							
	41607-73	41607-82	41608-57	41608-80	41609-70		
	41607-73 T	41607-82 T	41608-57 T	41608-80 T	41609-70 T		
	7,2 mm	8,2 mm	5,7 mm	8,0 mm	7,0 mm		
	200 gms	200 gms	200 gms	200 gms	200 gms		

YASARGIL – Aneurysmen – Gefäß – Clips
 YASARGIL – Aneurysm – Vessel – Clips
 YASARGIL – Clips para aneurisma
 YASARGIL – Clips per aneurisma

aus hochwertigem Implantat-Stahl antimagnetisch
 in high quality Implant steel antimagnetic
 de acero inoxidable para implantes de alta calidad, antimagnético
 Prodotto in acciaio di alta qualità, antimagnetico

YASARGIL-STANDARD für temporären Verschluss
 YASARGIL-STANDARD for temporary closure
 YASARGIL-STANDARD para cierre temporal
 YASARGIL-STANDARD con chiusura temporanea

Standard

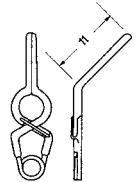
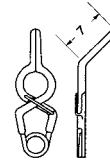
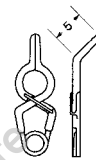
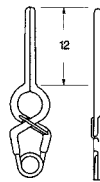
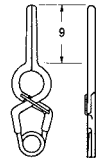
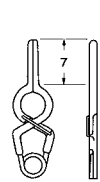
Cat. Nr.	41610-61	41610-68	41610-70	41611-74	41611-87	41611-92
	41610-61 T	41610-68 T	41610-70 T	41611-74 T	41611-87 T	41611-92 T
max. opening	6,1 mm	6,8 mm	7,0 mm	7,4 mm	8,7 mm	9,2 mm
Force	70 gms	70 gms	70 gms	70 gms	70 gms	70 gms
	41612-07	41612-09	41612-11	41612-12	41612-62	
	41612-07 T	41612-09 T	41612-11 T	41612-12 T	41612-62 T	
	7,5 mm	9,9 mm	11,0 mm	11,4 mm	6,2 mm	
	90 gms	90 gms	90 gms	90 gms	70 gms	

YASARGIL – Aneurysmen – Gefäß – Clips
 YASARGIL – Aneurysm – Vessel – Clips
 YASARGIL – Clips para aneurisma
 YASARGIL – Clips per aneurisma

aus hochwertigem Implantat-Stahl antimagnetisch
 in high quality Implant steel antimagnetic
 de acero inoxidable para implantes de alta calidad, antimagnético
 Prodotto in acciaio di alta qualità, antimagnetico

YASARGIL-STANDARD für permanenten Verschluss
 YASARGIL-STANDARD for permanent closure
 YASARGIL-STANDARD para cierre permanente
 YASARGIL-STANDARD con chiusura permanente

Standard



Cat. Nr.

41613-74

41613-84

41613-96

41614-58

41614-65

41614-72

max. opening
Force

41613-74 T

41613-84 T

41613-96 T

41614-58 T

41614-65 T

41614-72 T

7,4 mm
150 gms

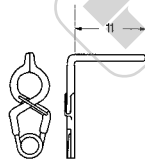
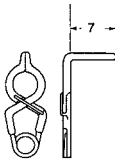
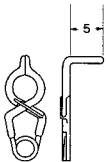
8,4 mm
150 gms

9,6 mm
180 gms

5,8 mm
150 gms

6,5 mm
150 gms

7,2 mm
180 gms



41615-49

41615-50

41615-51

41615-49 T

41615-50 T

41615-51 T

4,9 mm
150 gms

4,9 mm
150 gms

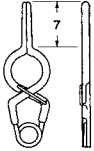
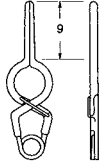
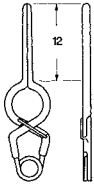
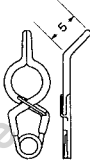
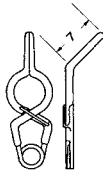
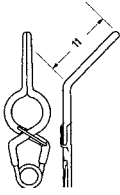
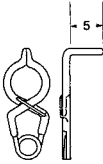
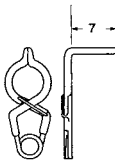
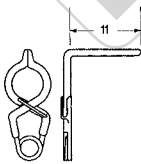
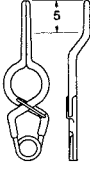
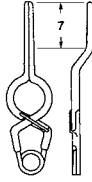
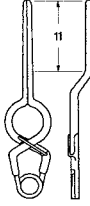
4,9 mm
180 gms

YASARGIL – Aneurysmen – Gefäß – Clips
 YASARGIL – Aneurysm – Vessel – Clips
 YASARGIL – Clips para aneurisma
 YASARGIL – Clips per aneurisma

aus hochwertigem Implantat-Stahl antimagnetisch
 in high quality Implant steel antimagnetic
 de acero inoxidable para implantes de alta calidad, antimagnético
 Prodotto in acciaio di alta qualità, antimagnetico

YASARGIL-STANDARD für permanenten Verschluss
 YASARGIL-STANDARD for permanent closure
 YASARGIL-STANDARD para cierre permanente
 YASARGIL-STANDARD con chiusura permanente

Standard

						
Cat. Nr.	41616-79	41616-91	41617-10	41617-65	41617-72	41617-78
	41616-79 T	41616-91 T	41617-10 T	41617-65 T	41617-72 T	41617-78 T
max. opening	7,9 mm	9,1 mm	10,3 mm	6,5 mm	7,2 mm	7,8 mm
Force	150 gms	150 gms	180 gms	150 gms	150 gms	180 gms
						
	41618-55	41618-56	41618-57	41618-79	41618-88	41619-00
	41618-55 T	41618-56 T	41618-57 T	41618-79 T	41618-88 T	41619-00 T
	5,5 mm	5,5 mm	5,5 mm	7,9 mm	8,8 mm	10,0 mm
	150 gms	150 gms	180 gms	150 gms	150 gms	180 gms

YASARGIL – Aneurysmen – Gefäß – Clips

YASARGIL – Aneurysm – Vessel – Clips

YASARGIL – Clips para aneurisma

YASARGIL – Clips per aneurisma

aus hochwertigem Implantat-Stahl antimagnetisch
 in high quality Implant steel antimagnetic
 de acero inoxidable para implantes de alta calidad, antimagnético
 Prodotto in acciaio di alta qualità, antimagnetico

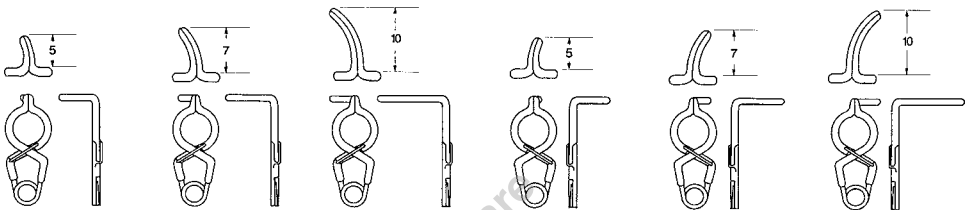
YASARGIL-STANDARD für permanenten Verschluss

YASARGIL-STANDARD for permanent closure

YASARGIL-STANDARD para cierre permanente

YASARGIL-STANDARD con chiusura permanente

Standard



Cat. Nr.

41620-58

41620-59

41620-60

41620-61

41620-62

41620-63

max. opening
Force

41620-58 T

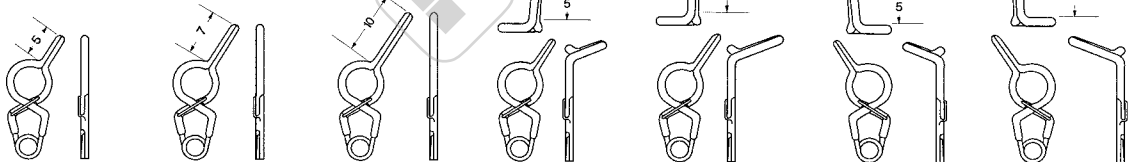
41620-59 T

41620-60 T

41620-61 T

41620-62 T

41620-63 T

5,8 mm
150 gms5,8 mm
150 gms5,8 mm
150 gms5,8 mm
150 gms5,8 mm
150 gms5,8 mm
150 gms

41620-70

41620-78

41620-88

41621-58

41621-62

41622-58

41622-62

41620-70 T

41620-78 T

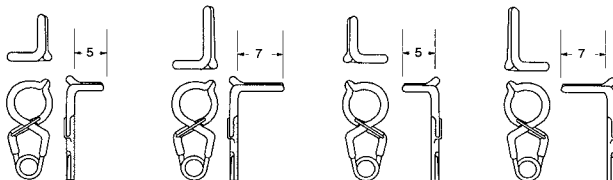
41620-88 T

41621-58 T

41621-62 T

41622-58 T

41622-62 T

7,0 mm
150 gms7,8 mm
150 gms8,8 mm
150 gms5,8 mm
150 gms6,2 mm
150 gms5,8 mm
150 gms6,2 mm
150 gms

41623-56

41624-56

41625-56

41626-56

41623-56 T

41624-56 T

41625-56 T

41626-56 T
















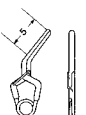

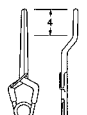
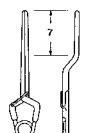
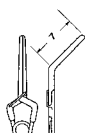
5,6 mm
150 gms5,6 mm
150 gms5,6 mm
150 gms5,6 mm
150 gms

YASARGIL – Aneurysmen – Gefäß – Clips
 YASARGIL – Aneurysm – Vessel – Clips
 YASARGIL – Clips para aneurisma
 YASARGIL – Clips per aneurisma

aus hochwertigem Implantat-Stahl antimagnetisch
 in high quality Implant steel antimagnetic
 de acero inoxidable para implantes de alta calidad, antimagnético
 Prodotto in acciaio di alta qualità, antimagnetico

YASARGIL-STANDARD für permanenten Verschluss
 YASARGIL-STANDARD for permanent closure
 YASARGIL-STANDARD para cierre permanente
 YASARGIL-STANDARD con chiusura permanente

Mini

							
Cat. Nr.	41627-33	41627-40	41628-33	41628-40	41628-46	41629-32	
	41627-33 T	41627-40 T	41628-33 T	41628-40 T	41628-46 T	41629-32 T	
max. opening	3,3 mm	4,0 mm	3,3 mm	4,0 mm	4,6 mm	3,2 mm	
Force	110 gms	110 gms	110 gms	110 gms	110 gms	110 gms	
							
	41629-38	41630-36	41630-38	41631-36	41631-40	41631-44	41632-36
	41629-38 T	41630-36 T	41630-38 T	41631-36 T	41631-40 T	41631-44 T	41632-36 T
	3,8 mm	3,6 mm	3,8 mm	3,6 mm	4,0 mm	4,4 mm	3,6 mm
	110 gms	110 gms	110 gms	110 gms	110 gms	110 gms	110 gms
							
	41633-35	41633-40	41634-35	41634-60	41634-70	41635-57	41636-45
	41633-35 T	41633-40 T	41634-35 T	41634-60 T	41634-70 T	41635-57 T	41636-45 T
	3,5 mm	4,0 mm	3,5 mm	6,0 mm	7,0 mm	5,7 mm	4,5 mm
	110 gms	110 gms	130 gms	130 gms	130 gms	130 gms	130 gms

YASARGIL – Aneurysmen – Gefäß – Clips
 YASARGIL – Aneurysm – Vessel – Clips
 YASARGIL – Clips para aneurisma
 YASARGIL – Clips per aneurisma

aus hochwertigem Implantat-Stahl antimagnetisch
 in high quality Implant steel antimagnetic
 de acero inoxidable para implantes de alta calidad, antimagnético
 Prodotto in acciaio di alta qualità, antimagnetico

YASARGIL-STANDARD für temporären Verschluss
 YASARGIL-STANDARD for temporary closure
 YASARGIL-STANDARD para cierre temporal
 YASARGIL-STANDARD con chiusura temporanea

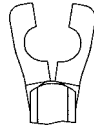
Mini

Cat. Nr.	41637-33	41637-40	41638-38	41638-46	41639-44	41640-40
	41637-33 T	41637-40 T	41638-38 T	41638-46 T	41639-44 T	41640-40 T
max. opening	3,3 mm	4,0 mm	3,8 mm	4,6 mm	4,4 mm	4,0 mm
Force	50 gms	50 gms	50 gms	70 gms	70 gms	70 gms

Anlegezange mit Rundgriff – FLEXIBEL – mit und ohne drehbarem Maulteil
 Applying forceps with round shaft – FLEXIBLE – with and without Rotation
 Pinzas de aplicación con mango redondo – FLEXIBLE – con y sin rotación
 Posa clips con manico rotonda guaina FLESSIBILE cover sistema rotante ed non rotante

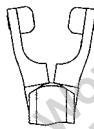
Länge Length Largo Lunghezza	MINI	STANDARD
70 mm	41641-07	41643-07
90 mm	41641-09	41643-09
110 mm	41641-11	41643-11

nicht drehbar
non rotating
sin rotación
non rotante



Länge Length Largo Lunghezza	MINI	STANDARD
70 mm	41642-07	41644-07
90 mm	41642-09	41644-09
110 mm	41642-11	41644-11

drehbar
rotating
rotante
rotante

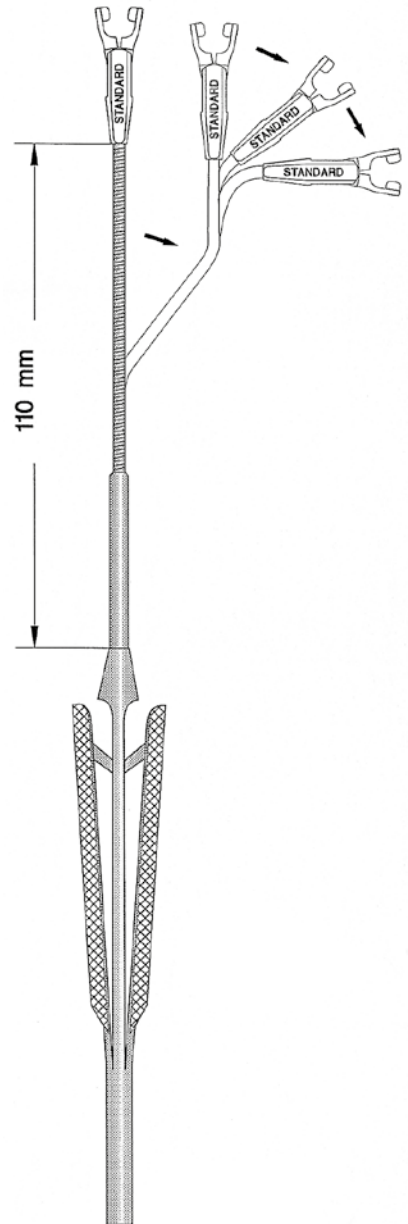
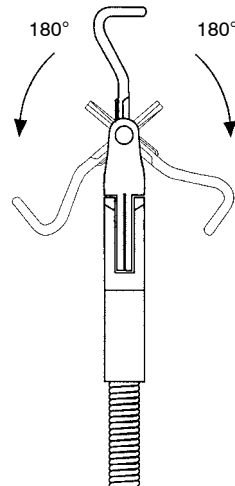


drehbar
rotating
rotante
rotante



Beispiel für Drehmechanismus
Example for Rotation
Ejemplo de la rotación
Esempio della rotazione

Clips drehbar im Maul
Clips rotabile in jaw
Clips rotabile en la boca
Clips rotabile nel morso

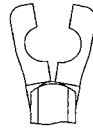


41641-07 - 41644-11

Anlegezange mit Rundgriff – starr – mit und ohne drehbarem Maulteil
 Applying forceps with round shaft – rigid – with and without Rotation
 Pinzas de aplicación con mango redondo – rigido – con y sin rotación
 Posa clips con manico rotonda guaina rigida cover sistema rotante ed non rotante

Länge Length Largo Lunghezza	MINI	STANDARD
70 mm	41645-07	41647-07
90 mm	41645-09	41647-09
110 mm	41645-11	41647-11

nicht drehbar
non rotating
sin rotación
non rotante

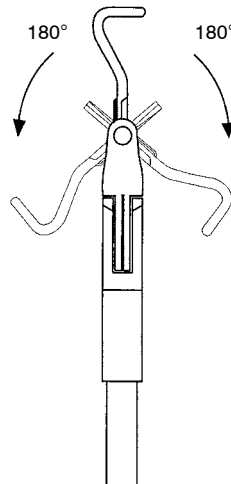


Länge Length Largo Lunghezza	MINI	STANDARD
70 mm	41646-07	41648-07
90 mm	41646-09	41648-09
110 mm	41646-11	41648-11

drehbar
rotating
rotante
rotante

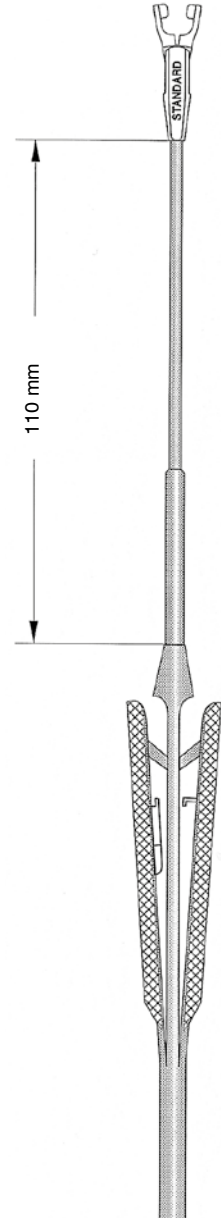


drehbar
rotating
rotante
rotante



Beispiel für Drehmechanismus
Example for Rotation
Ejemplo de la rotación
Esempio della rotazione

Clips drehbar im Maul
Clips rotabile in jaw
Clips rotabile en la boca
Clips rotabile nel morso

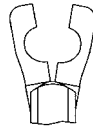


41645-07 - 41648-11

Anlegezange mit Rundgriff – starr – mit und ohne drehbarem Maulteil
 Applying forceps with round shaft – rigid – with and without Rotation
 Pinzas de aplicación con mango redondo – rígido – con y sin rotación
 Posa clips con manico rotonda guaina rigida cover sistema rotante ed non rotante

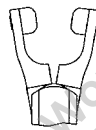
Länge Length Largo Lunghezza	MINI	STANDARD
70 mm	41649-07	41651-07
90 mm	41649-09	41651-09
110 mm	41649-11	41651-11

nicht drehbar
non rotating
sin rotación
non rotante

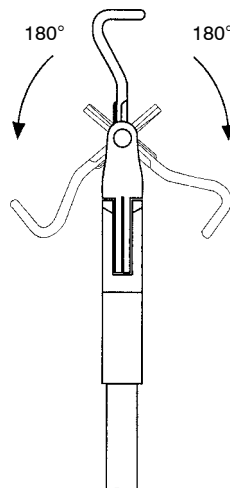


Länge Length Largo Lunghezza	MINI	STANDARD
70 mm	41650-07	41652-07
90 mm	41650-09	41652-09
110 mm	41650-11	41652-11

drehbar
rotating
rotante
rotante

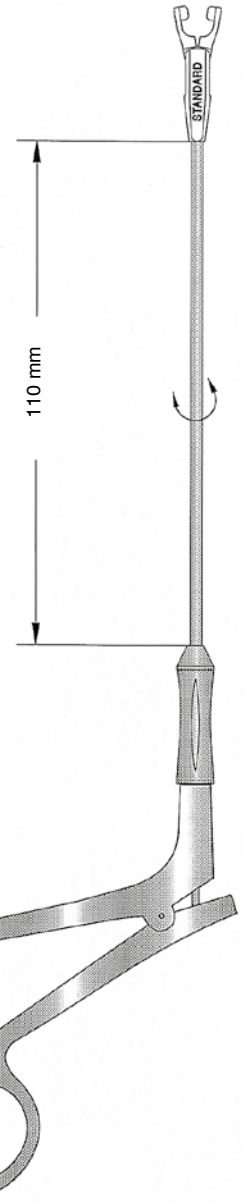


drehbar
rotating
rotante
rotante



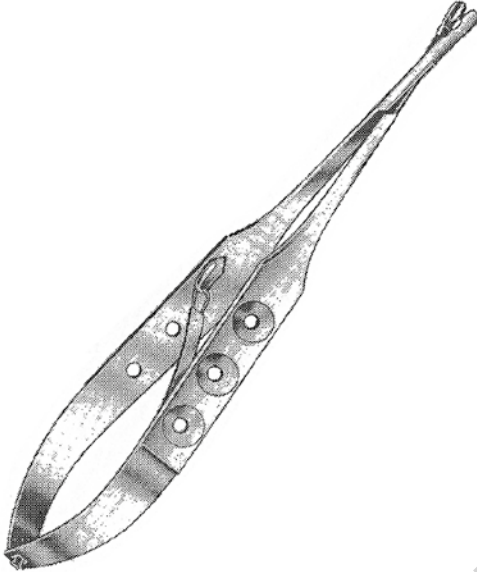
Beispiel für Drehmechanismus
Example for Rotation
Ejemplo de la rotación
Esempio della rotazione

Clips drehbar im Maul
Clips rotabile in jaw
Clips rotabile en la boca
Clips rotabile nel morso



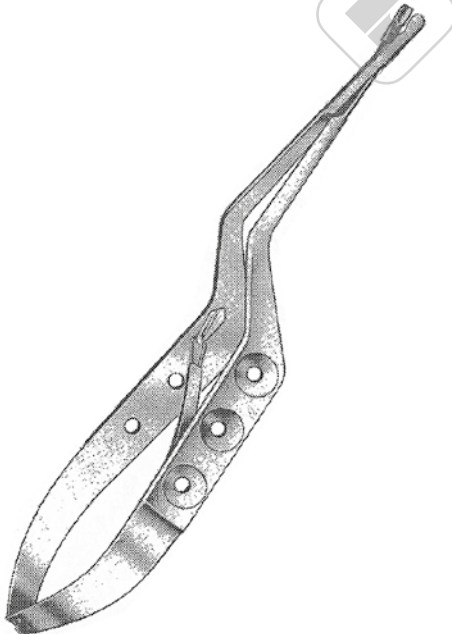
41649-07 - 41652-11

Anlegezange – mit und ohne drehbarem Maulteil
 Applying Forceps – with and without Rotation
 Pinzas de aplicación, con y sin rotación
 Pinza posa clips, con ed senza rotazione



MINI	41653-18	
STANDARD	41654-18	
MINI	41655-18	drehbar / rotating rotante / rotante
STANDARD	41656-18	drehbar / rotating rotante / rotante

Anlegezange gerade, mit Sperre, Länge 18 cm, 7"
 Applying Forceps straight, with Ratchet, Length 18 cm, 7"
 Pinza de aplicación, con cremallera, 18 cm, 7"
 Posa clips, retta con bloccaggio lunghezza 18 cm, 7"

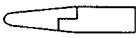




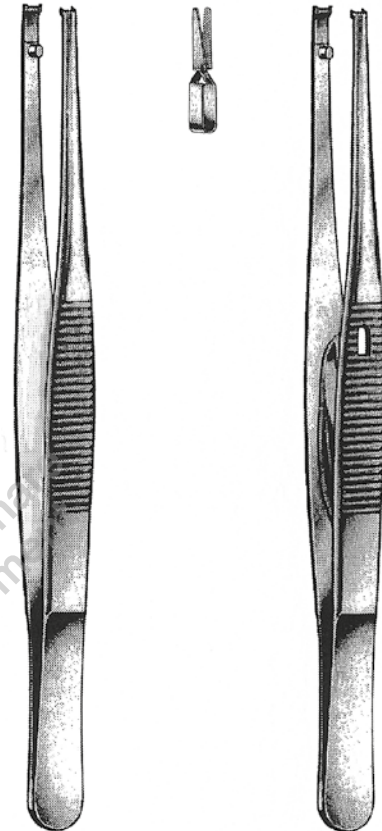
Länge			
Length			
Largo			
Lunghezza	17 cm, 6 3/4"	21 cm, 8 1/4"	23 cm, 9"
MINI	41657-17	41657-21	41657-23
STANDARD	41658-17	41658-21	41658-23
MINI	41659-17	41659-21	41659-23
	drehbar / rotating / rotante / rotante		
STANDARD	41660-17	41660-21	41660-23
	drehbar / rotating / rotante / rotante		

Clips drehbar im Maul
 Clips rotatable in jaw
 Clips rotatable en la boca
 Clips rotabile nel morso

Anlegezange bayonett, mit Sperre
 Applying Forceps bayonett, with Ratchet
 Pinza de aplicación bayoneta, con cremallera
 Posa clips a baionetta con bloccaggio

Gefäßclips nach BIEMER
BIEMER Vessel Clips
Clips para vasos de BIEMER
Clips per vasi secondo BIEMER

	Maulöffnung Opening	Maullänge Length of jaws	Schließkraft Closing Force
 41661-40	Apertura de la boca Apertura del morso 4,0 mm	Largo de la boca Lunghezza del morso 6,0 mm	Fuerza del cierre Forza di chiusura 30 - 40 g (0,29 - 0,39 N)
 41661-50	5,0 mm	9,0 mm	30 - 40 g (0,29 - 0,39 N)
 41662-50	5,0 mm	9,0 mm	20 - 25 g (0,20 - 0,25 N)



für temporären Gebrauch

gekennzeichnet durch gelb eingefärbte Federenden
für Gefäße mit einem Durchmesser 0,5 - 2,0 mm

Maulinnenflächen schräg gerieft für schonendes,
sicheres Festhalten der Gefäße

Der fest eingestellte Schließdruck gewährt risikofreie
Anwendung

for temporary occlusion

(identified by yellow coloured spring ends) for vessel
diam. 0,5 - 2,0 mm

Blade gripping surface with oblique serrations for
save but careful gripping of vessels

No risk due to rigidly fixed pressure measure

para uso temporal

clips marcados con baño dorado en los resortes,
para vasos con un diámetro de 0,5 - 2,0 mm

El interior de las quijadas viene con estrias finas para
un agarre seguro y cuidadoso de los vasos

Debido a la calibración exacta de la fuerza de cierre
se ofrece una aplicación sin riesgo

per chiusura temporanea

per vasi con Diametro 0,5 - 2,0 mm

La chiusura regolata garantisce nessun rischio

BIEMER
41663-01

Anlegepinzette ohne Schloß,
für Mikro-Gefäßclips
41661-40 - 41662-50
und
Approximatoren
41667-30 - 41670-50
und
41672-01 - 41672-04

Applying forceps without lock.
for vessel clips
41661-40 - 41662-50
and
Aproximators
41667-30 - 41670-50
and
41672-01 - 41672-04

BIEMER
41663-02

Anlegepinzette mit Schloß,
für Mikro-Gefäßclips
41661-40 - 41662-50
und
Approximatoren
41667-30 - 41670-50
und
41672-01 - 41672-04

Applying forceps with lock.
for vessel clips
41661-40 - 41662-50
and
Aproximators
41667-30 - 41670-50
and
41672-01 - 41672-04

Gefäßclips nach MEHDORN
MEHDORN Vessel Clips
Clips para vasos de MEHDORN
Clips secondo MEHDORN

für temporären Gebrauch

gekennzeichnet durch gelb eingefärbte Federenden für Gefäße mit einem Durchmesser 0,5 - 1,5 mm

Maulinnenflächen schräg gerieft für schonendes, sicheres Festhalten der Gefäße

Der fest eingestellte Schließdruck gewährt risikofreie Anwendung

for temporary occlusion

(identified by yellow coloured spring ends) for vessel diam. 0,5 - 1,5 mm

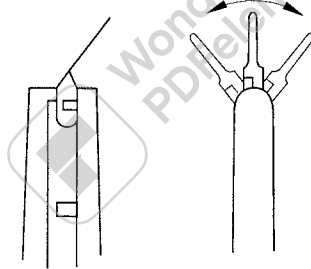
Blade gripping surface with oblique serrations for save but careful gripping of vessels

No risk due to rigidly fixed pressure measure

Beispiele für die variable Position des Clips

Ejemplo para la variedad de la aplicación del clip

Esempio: posizioni variabili delle clips



para uso temporal

clips marcados con baño dorado en los resortes, para vasos con un diámetro de 0,5 - 1,5 mm

El interior de las quijadas viene con estrias finas para un agarre seguro y cuidadoso de los vasos

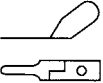
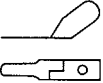
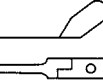
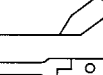
Debido a la calibración exacta de la fuerza de cierre se ofrece una aplicación sin riesgo

per chiusura temporanea

per vasi con Diametro 0,5 - 1,5 mm

La chiusura regolata garantisce nessun rischio



	Maullänge Length of jaws Largo de la boca Lunghezza del morso	Schließkraft Closing Force Fuerza del cierre Forza di chiusura	MEHDORN 41666-00
	41664-10 4 x 1,0 mm	10 - 15 g (0,10 - 0,15 N)	Anlegepinzette für Mikro- Gefäßclips 41664-10 - 41665-14
	41664-14 4 x 1,4 mm	15 - 20 g (0,15 - 0,20 N)	Applying Forceps for vessel clips 41664-10 - 41665-14
	41665-10 6 x 1,0 mm	10 - 15 g (0,10 - 0,15 N)	Pinza de aplicación para micro-clips 41664-10 - 41665-14
	41665-14 6 x 1,4 mm	15 - 20 g (0,15 - 0,20 N)	Pinza posa clips per microvasi 41664-10 - 41665-14

Approximatoren nach Biemer-Müller Approximators Biemer-Müller Aproximadores de Biemer-Müller Aprossimatore secondo Biemer-Müller

für temporären Gebrauch

gekennzeichnet durch gelb eingefärbte Federenden für Gefäße mit einem Durchmesser 0,5 - 2,0 mm
Maulinnenflächen schräg gerieft für schonendes, sicheres Festhalten der Gefäße
Der fest eingestellte Schließdruck gewährt risikofreie Anwendung

for temporary occlusion

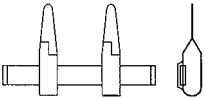
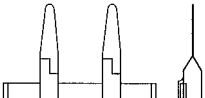
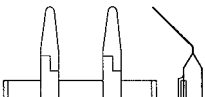
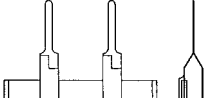
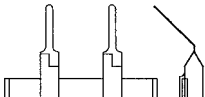
(identified by yellow coloured spring ends) for vessel diam. 0,5 - 2,0 mm
Blade gripping surface with oblique serrations for save but careful gripping of vessels
No risk due to rigidly fixed pressure measure

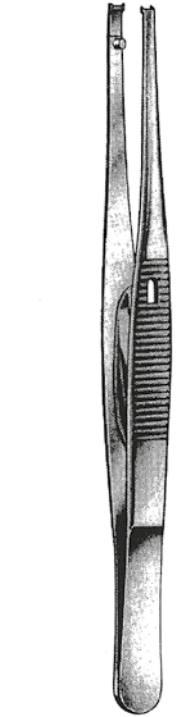
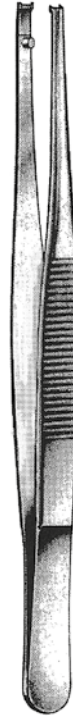
para uso temporal

clips marcados con baño dorado en los resortes, para vasos con un diámetro de 0,5 - 2,0 mm
El interior de las quijadas viene con estrias finas para un agarre seguro y cuidadoso de los vasos
Debido a la calibración exacta de la fuerza de cierre se ofrece una aplicación sin riesgo

per chiusura temporanea

per vasi con Diametro 0,5 - 2,0 mm
La chiusura regolata garantisce nessun rischio

	Maulöffnung Opening	Maullänge Length of jaws	Schließkraft Closing Force
	3,0 mm	4,5 mm	30 - 40 g (0,29 - 0,39 N)
	5,0 mm	9,0 mm	30 - 40 g (0,29 - 0,39 N)
	5,0 mm	9,0 mm	30 - 40 g (0,20 - 0,25 N)
	5,0 mm	9,0 mm	30 - 40 g (0,20 - 0,25 N)
	5,0 mm	9,0 mm	30 - 40 g (0,20 - 0,25 N)



BIEMER
41663-01

BIEMER
41663-02

Anlegepinzette ohne
Schloß,
für Mikro-Gefäßclips
41661-40 - 41662-50
und
Approximatoren
41667-30 - 41670-50
und
41672-01 - 41672-04

Anlegepinzette mit
Schloß,
für Mikro-Gefäßclips
41661-40 - 41662-50
und
Approximatoren
41667-30 - 41670-50
und
41672-01 - 41672-04

Applying forceps without
lock.
for vessel clips
41661-40 - 41662-50
and
Aproximadores
41667-30 - 41670-50
and
41672-01 - 41672-04

Applying forceps with
lock.
for vessel clips
41661-40 - 41662-50
and
Aproximadores
41667-30 - 41670-50
and
41672-01 - 41672-04

Approximatoren nach Müller
Müller Approximators
Aproximadores de Müller
Aprossimatore secondo Müller

für temporären Gebrauch

gekennzeichnet durch gelb eingefärbte Federenden für Gefäße mit einem Durchmesser 0,5 - 2,0 mm
Maulinnenflächen schräg gerieft für schonendes, sicheres Festhalten der Gefäße
Der fest eingestellte Schließdruck gewährt risikofreie Anwendung

for temporary occlusion

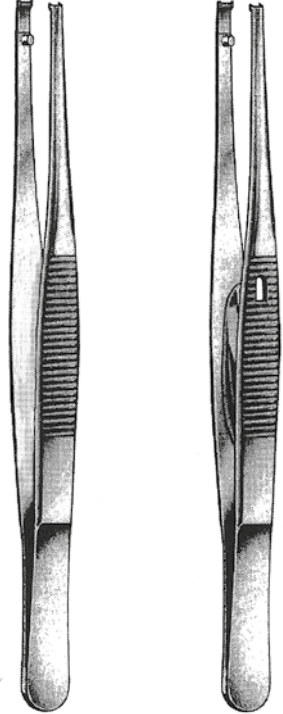
(identified by yellow coloured spring ends) for vessel diam. 0,5 - 2,0 mm
Blade gripping surface with oblique serrations for save but careful gripping of vessels
No risk due to rigidly fixed pressure measure

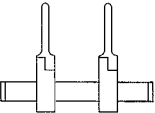

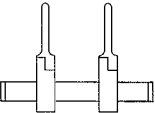

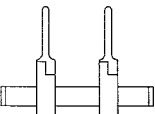

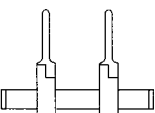

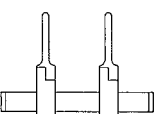

para uso temporal

clips marcados con baño dorado en los resortes, para vasos con un diámetro de 0,5 - 2,0 mm
El interior de las quijadas viene con estrías finas para un agarre seguro y cuidadoso de los vasos
Debido a la calibración exacta de la fuerza de cierre se ofrece una aplicación sin riesgo

per chiusura temporanea

per vasi con Diametro 0,5 - 2,0 mm
La chiusura regolata garantisce nessun rischio



		Ø Diameter	Schließkraft Closing Force Fuerza del cierre Forza di chiusura
		1,0 mm	25 - 30 g (0,25 - 0,29 N)
		2,0 mm	25 - 30 g (0,25 - 0,29 N)
		3,0 mm	25 - 30 g (0,25 - 0,29 N)
		4,0 mm	25 - 30 g (0,25 - 0,29 N)

BIEMER
41663-01

Anlegepinzette ohne
Schloß,
für Mikro-Gefäßclips
41661-40 - 41662-50
und
Approximatoren
41667-30 - 41670-50
und
41672-01 - 41672-04

Applying forceps without
lock.
for vessel clips
41661-40 - 41662-50
and
Aproximadores
41667-30 - 41670-50
and
41672-01 - 41672-04

BIEMER
41663-02

Anlegepinzette mit
Schloß,
für Mikro-Gefäßclips
41661-40 - 41662-50
und
Approximatoren
41667-30 - 41670-50
und
41672-01 - 41672-04

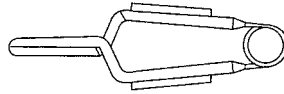
Applying forceps with
lock.
for vessel clips
41661-40 - 41662-50
and
Aproximadores
41667-30 - 41670-50
and
41672-01 - 41672-04

Gefäßclips nach Müller
Müller Vessel Clips
Clips para vasos de Müller
Clip secondo Müller

für temporären Gebrauch

Maulinnenflächen pyramidenförmig für schonendes, sicheres Festhalten der Gefäße

Der fest eingestellte Schließdruck gewährt risikofreie Anwendung



41674-50

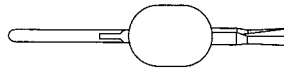
Schließkraft
Closing Force
Fuerza del cierre
Forza di chiusura

50 g

for temporary occlusion

Blade gripping surface with pyramid-like impressions for save but careful gripping of vessels

No risk due to rigidly fixed pressure measure



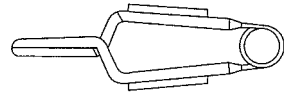
41674-80

80 g

para uso temporal

El interior de las quijadas viene en forma de pirámide para un agarre seguro y cuidadoso de los vasos.

Debido a la calibración exacta de la fuerza de cierre se ofrece una aplicación sin riesgo.



41675-50

50 g

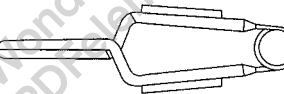


41675-80

80 g

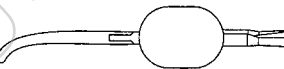
per uso temporaneo

Morso interno con forma piramidale per garantire una chiusura sicura del vaso



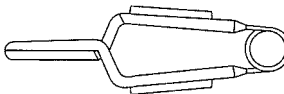
41676-50

50 g



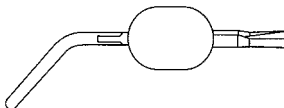
41676-80

80 g



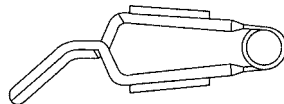
41677-50

50 g



41677-80

80 g



41678-50

50 g



41678-80

80 g

Approximator nach Biemer
 Biemer Approximator
 Aproximadores de Biemer
 Approssimatore secondo Biemer

für Mikro-Gefäßanastomosen im oberflächlichen Bereich

Maulinnenflächen schräg gerieft für schonendes, sicheres Festhalten der Gefäße

Der fest eingestellte Schließdruck gewährt risikofreie Anwendung

Der Abstand zwischen den Clips ist durch einfaches Verschieben einzustellen und wird durch Verkanten fixiert

for micro vessel anastomosis in the superficial range

Blade gripping surface with oblique serrations for save but careful gripping of vessels

No risk due to rigidly fixed pressure measure

Adjustable distance between the clips and automatic fixation by tilting

para micro-anastomosis en la superficie

El interior de la quijada viene con estrias finas para un agarre seguro y cuidadoso de los vasos.

Debido a la calibración exacta de la fuerza de cierre se ofrece una aplicación sin riesgo.

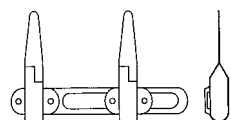
El espacio entre los clips se logra fácilmente por el desplazamiento.

per micro vasi anastomosi sulla parte della superficie

Parte interna del morso è leggermente striata obliqua per ottenere la presa sulla superficie del vaso.

La chiusura regolata garantisce nessun rischio.

Lo scorrimento delle due clips viene regolato con semplice movimento che consente una chiusura ottimale.



41679-25

Schließkraft
 Closing Force
 Fuerza de cierre
 Forza di chiusura

25 - 30 g
 (0,25 - 0,29 N)



BIEMER
 41680-00

Anlegepinzette für Gefäß-
 Approximator nach BIEMER

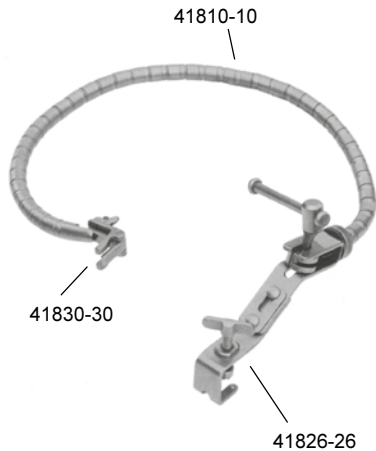
Applying forceps for BIEMER
 vessel approximator

Pinza de aplicación para
 aproximadores de BIEMER

Pinza posa clips per vasi
 approssimatori secondo
 BIEMER



LEYLA Retraktor System
LEYLA Retractor System
Separador de sistema LEYLA
LEYLA Sistema di fissaggio



YASARGIL

41801-01 Hirnspatelhalter, flexibel, für 1 flachen Spatel, komplett, bestehend aus:
brain retractor, flexible, for 1 flat spatula, complete, consisting of:
separador autoretentivo, flexible, para espátula con 1 brazo flexible, completo, compuesto de:
divaricatore autostatico, flessibile, per spatole piatte, con 1 braccio flessibile, completo, composto da:

41810-10 flexibler Spannarm
flexible arm
brazo flexible
braccio flessibile

41826-26 Fixiervorrichtung für 1 flexiblen Spannarm
fixation base for 1 flexible arm
fijador para 1 brazo flexible
fissatore per 1 braccio al braccio rigido

41830-30 Spatelhalter für flache Spatel
support for flat brain spatula
soporte para espátulas cerebrales planas
sostegno per spatole piatte

YASARGIL



41802-02 Hirnspatelhalter, flexibel für 2 flache Spatel, komplett, bestehend aus:
brain retractor, flexible, for 2 flat spatulas, complete, consisting of:
separador autoretentivo, flexible, para 2 espátulas planas con 2 brazos flexibles, completo, compuesto de:
divaricatore autostatico, flessibile, per spatole piatte, con 2 bracci flessibili, completo, composto da:

41810-10 flexibler Spannarm (2x)
flexible arm (2x)
brazo flexible (2x)
braccio flessibile (2x)

41822-22 Fixiervorrichtung für 2 flexible Spannarme
fixation base for 2 flexible arms
fijador para 2 brazos
fissatore per 2 bracci al cranio

41830-30 Spatelhalter für flache Spatel (2x)
support for flat brain spatula (2x)
soporte para espátulas cerebrales planas (2x)
sostegno per spatole piatte (2x)

LEYLA Retraktor System
 LEYLA Retractor System
 Separador de sistema LEYLA
 LEYLA Sistema di fissaggio

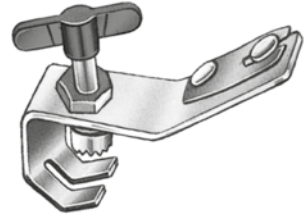
41821-21

Fixiervorrichtung für 1 flexiblen Spannarm zum Festschrauben an Rohrteilen bis
 ø 16 mm

Fixation base for mounting on bars up to ø16 mm, for 1 flexible arm

Fijador para 1 brazo flexible, para atornillar a tubos hasta 16 mm

Fissatore per 1 braccio al braccio rigido



41822-22

Fixiervorrichtung für 2 flexible Spannarme zum Festschrauben am Schädel

Fixation base for skull mounting, holding 2 flexible arms

Fijador para 2 brazos flexibles, para atornillar al cráneo

Fissatore per 2 bracci al cranio



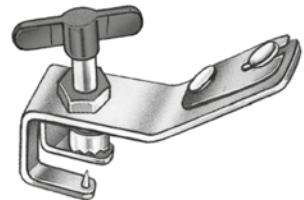
41826-26

Fixiervorrichtung für 1 flexiblen Spannarm zum Festschrauben am Schädel

Fixation base for skull mounting, holding 1 flexible arm

Fijador para 1 brazos flexibles, para atornillar al cráneo

Fissatore per 1 braccio al cranio



41830-30

Spatelhalter für flache Hirnspatel zur Befestigung am Spannarm

Support for flat brain spatula

Soporte para espátulas cerebrales planas para fijación al brazo flexible

Sostegno per spatole piatte



41832-32

Halter für Hirnspatel mit rundem Schaft bis ø 5,5 mm zur Befestigung am
 Spannarm

Support for brain spatula with round shaft

Soporte para espátulas cerebrales con mango redondo hasta ø 5,5 mm para
 fijación al brazo flexible

Sostegno flessibile per spatola cerebrale



LEYLA Retraktor System
LEYLA Retractor System
Separador de sistema LEYLA
LEYLA Sistema di fissaggio



YASARGIL

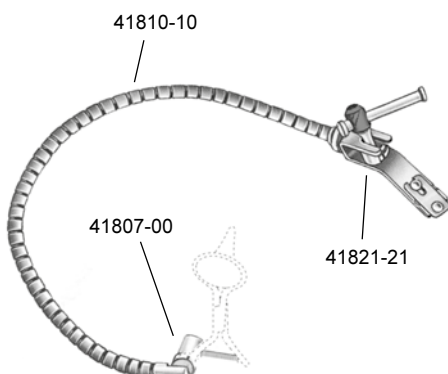
41810-10

flexibler Spannarm, allein
flexible arm, only
brazo flexible, suelto
braccio flessibile, solo

YASARGIL

41803-01

Ohrspekulahalter, komplett, bestehend aus:
ear specula holder, complete, consisting of:
soporte para espejos auriculares completo,
compuesto de:
sostegno per specchio auricolare, completo
composto da:



41810-10

flexibler Spannarm
flexible arm, only
brazo flexible, suelto
braccio flessibile, solo

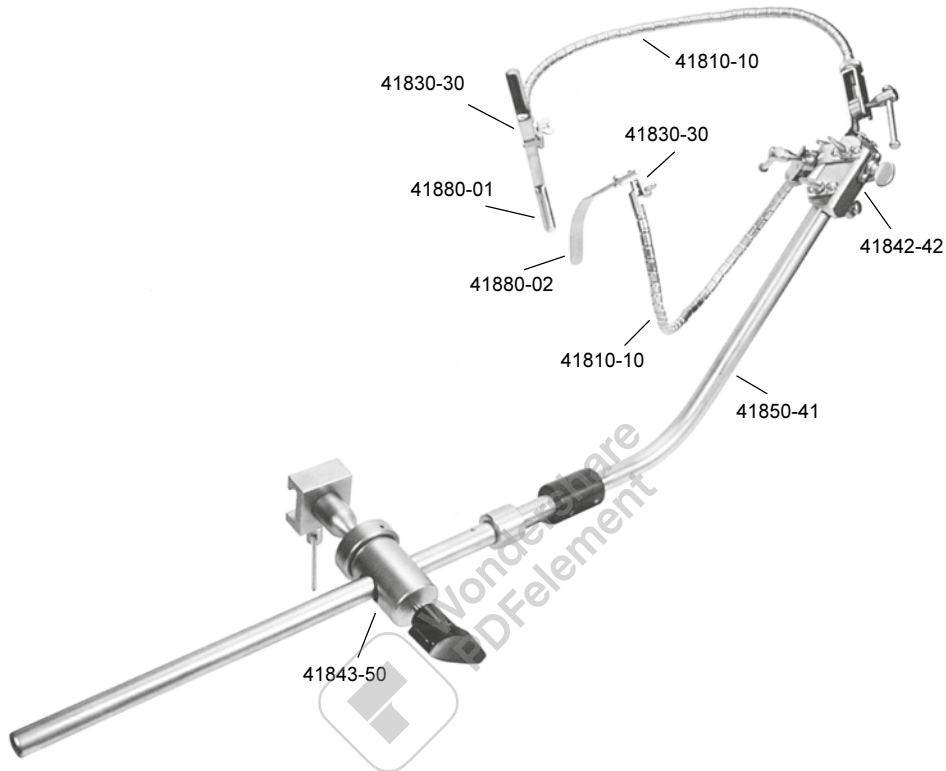
41821-21

Fixiervorrichtung zum Befestigen an Rohrteilen
bis Ø 16 mm
clamp for fixation on bars up to Ø 16 mm
fijador para 1 brazo flexible, para atornillar a
tubos hasta 16 mm
fissatore al braccio rigido Ø 16 mm

41807-00

Ohrtrichterhalter, allein
ear specula holder, only
soporte para espejos auriculares, suelto
sostegno per specchio auricolare

LEYLA Retraktor System
LEYLA Retractor System
Separador de sistema LEYLA
LEYLA Sistema di fissaggio



41802-00	LEYLA-Retraktor-System zum Fixieren am OP-Tisch komplett, bestehend aus: LEYLA Self-Retraining Retractor for fixation to operating table, complete, consisting of: Separador LEYLA para fijacion a la mesa de operaciones, completo, compuesto de: LEYLA Sistema di fissaggio al tavolo operatorio, composto da:	
41843-50	Kugelgelenkkloben (1x) ball and socket joint (1x) articulacion esferica (1x) giunto per fissare (1x)	41830-30 Spatelhalter für flache Spatel (2x) support for flat brain spatula (2x) soporte para espátulas cerebrales planas (2x) sostegno per spatole piatte (2x)
41850-41	starrer Haltearm (1x) rigid holding rod (1x) brazo de fijación rigido (1x) braccio di fissaggio rigido (1x)	41880-01 CUSHING Hirnspatel (1x) CUSHING brain spatula (1x) CUSHING espatula para cerebro (1x) CUSHING spatola cerebrale (1x)
41842-42	Kupplungskopf (1x) coupling head (1x) cabeza de acoplamiento (1x) giunto per combinare (1x)	41880-02 CUSHING Hirnspatel (1x) CUSHING brain spatula (1x) CUSHING espatula para cerebro (1x) CUSHING spatola cerebrale (1x)
41810-10	flexibler Spannarm (2x) flexible arm, only (2x) brazo flexible, suelto (2x) braccio flessibile, solo (2x)	

LEYLA Retraktor System
LEYLA Retractor System
Separador de sistema LEYLA
LEYLA Sistema di fissaggio



- 41843-50 Kugelgelenkkloben
zum Befestigen an der OP-
Tischschiene und zur Aufnahme
des Haltearms 41850-41

ball and socket joint
for fixation of holding rod 41850-41
at the operating table

articulacion esferica, para sujetar el
brazo de soporte rigido sobre la
mesa de operaciones 9 x 32 mm
giunto per fissare il braccio,
articolato 9 x 32 mm

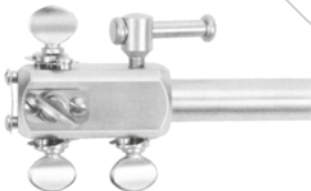


- 41850-41 starrer Haltearm, auseinandernehmbar, zur Fixation im
Kugelgelenkkloben 41843-50 und zur wahlweisen
Aufnahme der Kupplungsköpfe 41842-42, 41842-44 und
41842-46

holding rod, detachable, for fixation in ball and socket
joint 41843-50 and to hold a desired coupling head
41842-42, 41842-44 or 41842-46

brazo de soporte rigido, desmontable, para fijacion a la
articulacion esferica 41843-50 y opcionalmente a las
cabezas 41842-42, 41842-44 y 41842-46

braccio di sostegno rigido, per fissaggio al giunto
41843-50 e dei giunti 41842-42, 41842-44 e 41842-46



- 41842-42 Kupplungskopf, zur Aufnahme von
max. 5 flexiblen Spannarmen
41810-10

coupling head to hold 5 flexible
arms 41810-10

cabeza de acoplamiento para fijar
hasta 5 brazos flexibles
giunto per combinare 5 bracci



- 41842-44 Kupplungskopf, drehbar, zur Aufnahme von 1 flexiblen
Spannarm 41810-10

coupling head, turnable, to hold 1 flexible arm 41810-10
acoplamiento, girable y se puede fijar en todas las
posturas para sujetar un brazo flexible 41810-10

giunto per combinare, rotabile, per sostegno del braccio
41810-10

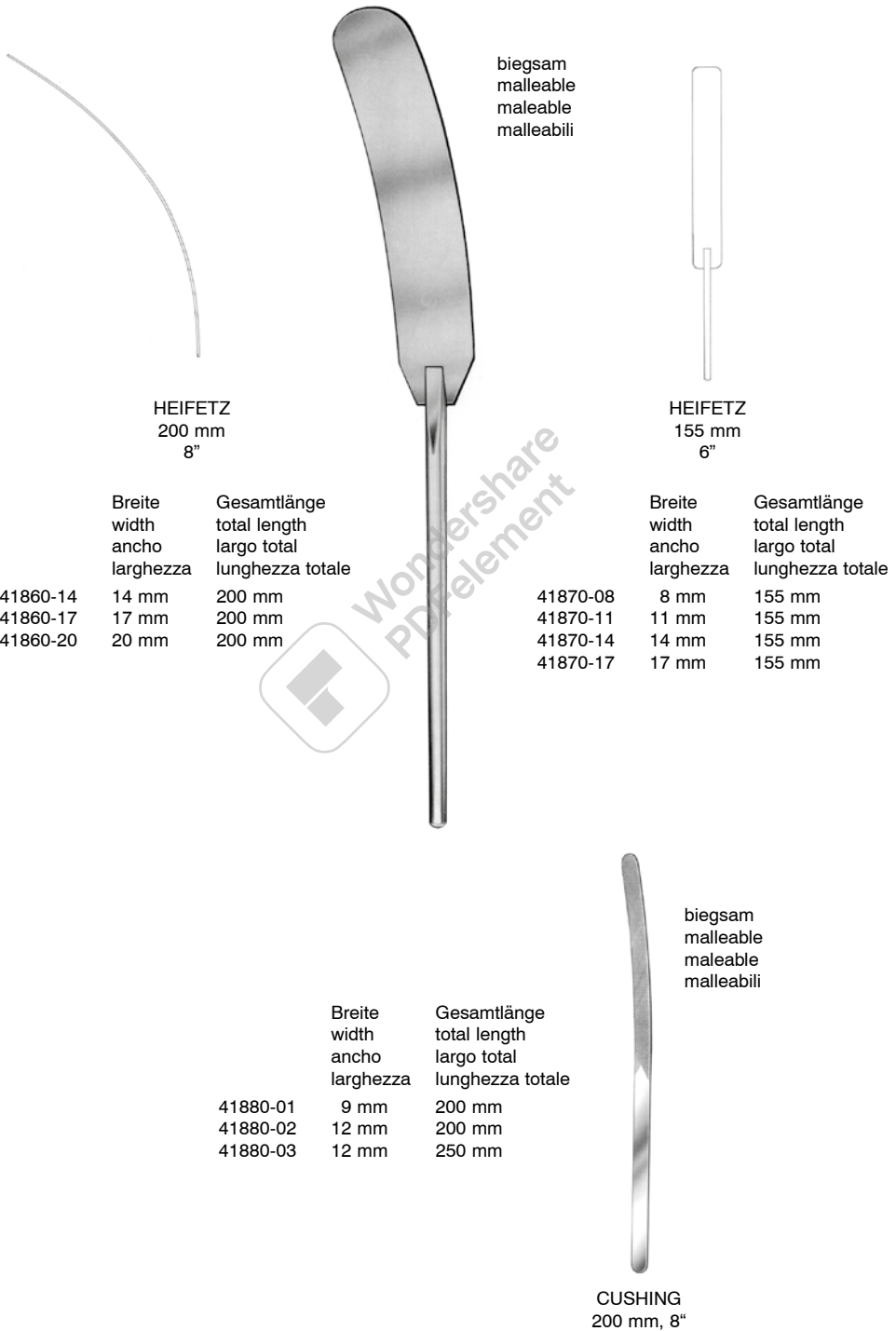
- 41842-46 Kupplungskopf, seitlich offen zur Aufnahme von 1
flexiblen Spannarm 41810-10

coupling head, lateral open, to hold 1 flexible arm
41810-10

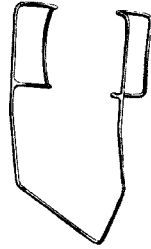
acoplamiento, abierto al lado, para un brazo flexible
41810-10

giunto per fissare il braccio, per 41810-10

Hirnspatel
Brain Spatulas
Espátula Cerebral
Spatole Cerebrali



Lidsperrer
Eye Specula
Blefaróstatos
Blefarostati



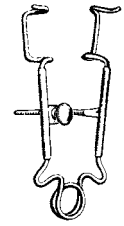
BARRAQUER (Colibri)

43101-03 3 cm, 1.2" für Kinder / children / niños / bambini
43101-04 4 cm, 1.6" für Erwachsene / adults / adultos / adulti



BOWMAN

43104-07
7 cm, 2 3/4"

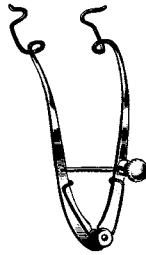


CRITCHETT

43105-06
7 cm, 2 3/4"



SMITH
43106-05
5 cm, 2"



CLARK
43107-08
8 cm, 3 1/8"



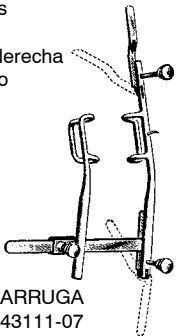
GRAEFE

43109-07 7 cm, 2 3/4"
43109-09 9 cm, 3 1/2"

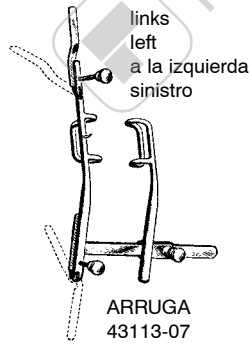


WEEK
43110-08
8 cm, 3 1/8"

rechts
right
a la derecha
destro

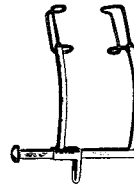


ARRUGA
43111-07
7 cm, 2 3/4"

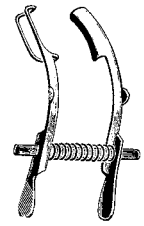


links
left
a la izquierda
sinistro

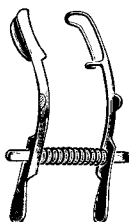
ARRUGA
43113-07
7 cm, 2 3/4"



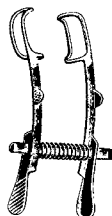
MURDOCK
43115-05
5 cm, 2"



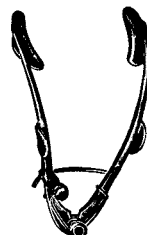
MELLINGER-AXENFELD
43121-07
7 cm, 2 3/4"



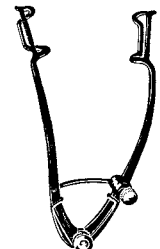
MELLINGER-AXENFELD
43123-07
7 cm, 2 3/4"



MELLINGER
43125-05 5 cm, 2"
43125-07 7 cm, 2 3/4"

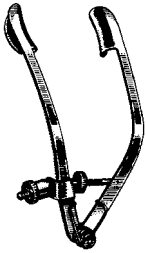


LISTER-BURCH
43127-08
8 cm, 3 1/8"



WILLIAMS
43128-08
8 cm, 3 1/8"

Lidsperrer, Lidplatte, Starmesser
 Eye Specula, Lid Plate, Cataract Knives
 Blefaróstatos, Placa para párpados, cuchillos para cataratas
 Blefarostati, Placca per palpebre, coltelli per cataratta



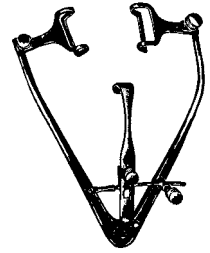
LANCASTER
 43129-07
 7 cm, 2 ³/₄"



ZIEGLER
 43130-07
 7 cm, 2 ³/₄"



CASTROVIEJO
 43132-08
 8 cm, 3 ¹/₈"



PARK
 43133-08
 8 cm, 3 ¹/₈"



MUELLER
 43135-07
 7 cm, 2 ³/₄"



STEVENSON
 43139-07
 7 cm, 2 ³/₄"



LIEBERMAN
 43140-08
 8 cm 3 ¹/₈"



LIEBERMAN
 43141-08
 8 cm 3 ¹/₈"



JAEGER
 43150-11
 11 cm, 4 ³/₈"



43170-00



43170-01



43170-02



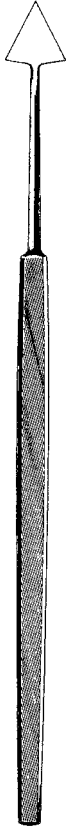
43170-03



DEUTSCHMANN
 43172-13
 13 cm, 5 ¹/₈"

GRAEFE
 43170-00 - 43170-03
 13 cm, 5 ¹/₈"

Lanzenmesser, Diszisionsmesser, Irismesser, Diszisionsmesser
 Cataract knife, keratome, Iris knife, discision knife
 Cuchillos lanceolares y Cuchillos de discisión
 Cheratom, bisturi p. capsule, bisturi corneale



43180-01
Fig. 1
13 cm, 5 1/8"



43180-02
Fig. 2
13 cm, 5 1/8"



43180-03
Fig. 3
13 cm, 5 1/8"



43181-01
Fig. 1

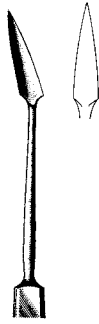


43181-02
Fig. 2



43181-03
Fig. 3

JAEGER 45°



BERENS
43183-13
13 cm, 5 1/8"



CASTROVIEJO
43185-13 13 cm
4 x 13 mm



GRAEFE
43187-13
13 cm, 5 1/8"



43202-01
Fig. 1
13 cm, 5 1/8"



KNAPP
43202-02
Fig. 2
13 cm, 5 1/8"



43202-03
Fig. 3
13 cm, 5 1/8"



ZIEGLER
43210-01 5 mm
Fig. 1
13 cm, 5 1/8"



ZIEGLER
43210-02 6 mm
Fig. 2
13 cm, 5 1/8"



ZIEGLER
43210-03 7 mm
Fig. 3
13 cm, 5 1/8"



DEAN
43213-12
12,5 cm, 5"

Hornhautmesser, Hornhautschaber, Dissektor, Sklerotom, Goniotomiemesser
 Corneal Scarifier, -dissector, sclerotome, goniotomy knife
 Cuchillos para cornea, legtras corneales, esclerótomos
 Spatole p. corneale, dissettores corneale, sclerotomo, coltello per goniotomia



WHEELER
43218-12
12 cm, 4 3/4"



ZIEGLER
43221-11
11 cm, 4 3/8"
3,5 mm



TOOK
43228-12
12 cm, 4 3/4"



GILL
43231-12
12 cm, 4 3/4"



ELSCHMIG
43233-13
13 cm, 5 1/8"



PATON
43245-12
12 cm, 4 3/4"



LUNDSGAARD
43251-12
12 cm, 4 3/4"



GUYTON-
LUNDSGAARD
43253-12



BARKAN
43256-12



SCHEIE
43258-12



BURCH
43262-12



PAUFIGUE
43271-11



BARRAQUER
43273-13

Diszisionsnadeln, Fremdkörpernadeln, Fremdkörperhohlmeißel
 Discision Needles, Foreign-Body Instruments
 Aguja de discisión, Instrumental para cuerpos extraños
 Aghi per discisione, strumenti per corpi estranei



43304-12



43305-12

BOWMAN
43308-12BOWMAN
43309-12

43310-13



43311-13

LEVINSON
43314-13FRANCIS
43321-12DAVIS
43325-13LA FORCE
43327-12DIX
43330-13ELLIS
43331-11WALTON
43332-12
1,4 mmWALTON
43334-12
1,4 mmALVIS
43336-12GREEN
43340-13ROLLET
43342-12

Schielhaken, Tenotomiehaken, Extraktionshaken, Tränenstichhaken
 Strabismus hook, lens hook, extraction hook
 Ganchos para estrabismo, - cristalino, extracción
 Uncino per il strabismo, uncino p. cristallino, protettori, uncini per l'iride



Fig. 1
GRAEFE
43351-01
13 cm, 5 1/8"



Fig. 2
GRAEFE
43351-02
14 cm, 5 1/2"



Fig. 3
GRAEFE
43351-03
15 cm, 6"



JAMESON
43353-13



GREEN
43355-13



STEVENS
43357-13



Fig. 1
ARRUGA
43363-01



Fig. 2
ARRUGA
43363-02



O'CONNER
43370-12



WIENER
43372-13



WIENER
43373-13



ROLLET
43376-13



KNAPP
43377-13



GRAEFE
43380-13



GRAEFE
43381-13

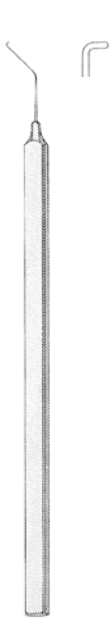


GRAEFE
43383-13



BECKER
43386-13

Implantations Instrumente
Instruments for Implantation
Instrumentos para implantaciòn
Strumenti per impianto



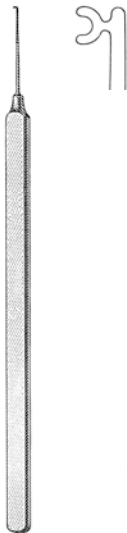
CLAYMAN
43387-02
11,5 cm 4 1/2"



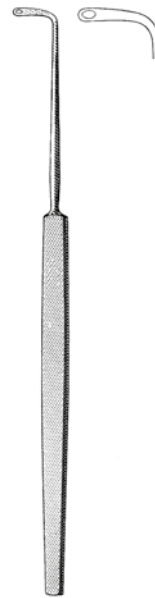
SINSKEY
43388-02
11,4 cm 4 1/2"



SINSKEY
43389-02
12 cm 4 3/4"

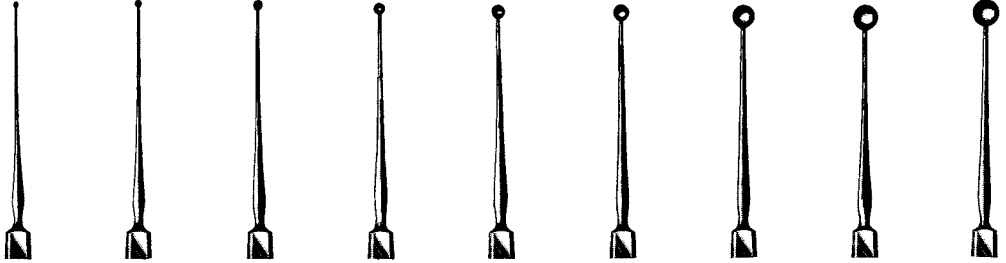


KUGLEN
43390-05
11,7 cm 4 5/8"



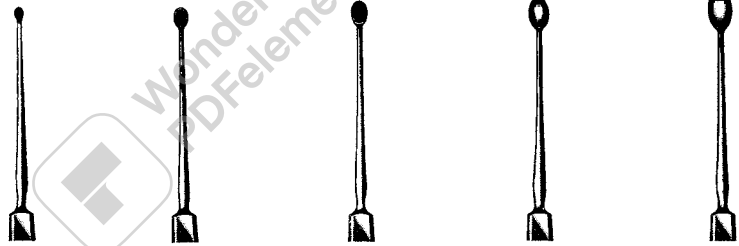
GASS
43391-13
14,6 cm 5 3/4"

Küretten und Löffel für Chalazion und Star
 Scoops and Curettes for Chalazio, Cataract, and Exenteration
 Curetas y cucharillas para chalazión, catarata y exenteración
 Curette e cucchiari per calazio, cateratta e palpebre



MEYHOEFER

- | | | | | | | | | | |
|------|----------|----------|----------|----------|----------|----------|----------|----------|----------|
| | 43402-05 | 43402-10 | 43402-15 | 43402-18 | 43402-20 | 43402-25 | 43402-35 | 43402-40 | 43402-45 |
| Ø mm | 0,5 | 1,0 | 1,5 | 1,8 | 2,0 | 2,5 | 3,5 | 4,0 | 4,5 |



- | | | | | | |
|------|----------|----------|----------|----------|----------|
| | HEBRA | HEBRA | HEBRA | HEBRA | HEBRA |
| | 43404-10 | 43404-20 | 43404-24 | 43404-30 | 43404-35 |
| Ø mm | 1,0 | 2,0 | 2,5 | 3,0 | 3,5 |



AXENFELD
43407-13



GRAEFE
43410-01



GRAEFE
43410-02



DAVIEL
43412-01
3 mm



DAVIEL
43412-02
4 mm

Starlöffel, Exenterationslöffel, Drahtschlingen, Starschlingen, Iris spatel, Enukleationslöffel, Wundlöffel
 Cataract Spoon, Exenteration Scoops, Lens Scoops, Spatulas, Protectores
 Cucharillas para Catarata-, exenteración, Asas, Espátulas, Protectores
 Cucchiaino per cateratta- esenterazione, Anse, Spatole, Protettori



KNAPP
43414-02



BUNGE
43420-01



BUNGE
43420-02



BUNGE
43420-03



LANG
43424-13



WEBER
43441-01
Fig. 1



43441-02
Fig. 2



SNELLEN
43443-13



WILDER
43445-13
Fig. 1



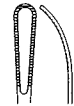
43447-13
Fig. 2



ARLT



43449-01



43449-02

Cautery
Cauter
Cauterio

Iris
Iride



WECKER
43461-13



WECKER
43462-13



WELLS
43482-20



ARRUGA
43485-13

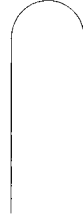


WADSWORTH-TODD
43487-14

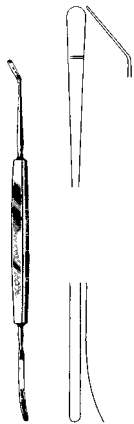
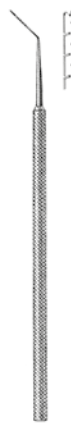
Zyklodialysespatel, Fremdkörperinstrumente
Cyclodialysis Spatula, Foreign Body Instruments
Espátulas para ciclodialísis, Instrumentos para cuerpos extraños
Spatole per ciclodialisi, Strumenti per corpi estranei



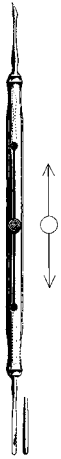
BANGERTER

43501-06
6 mm43501-10
10 mm43501-12
12 mm

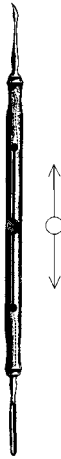
43511-13 - 43517-09

CASTROVIEJO
43511-13
1,2 x 10 mmCASTROVIEJO
43513-14
1,5 x 15 mmELSCHNIG
43515-14
1,2 x 12 mmCASTROVIEJO
43517-09
0,8 x 15 mmCASTROVIEJO
43521-12
12 cm, 4 3/4"WHEELER
43523-12
12 cm, 4 3/4"HIRSCHMAN
43524-10
12,5 cm, 5"CASTROVIEJO
43525-05 0,50 mm
43525-07 0,75 mm
43525-10 1,00 mmBECHERT
43526-12
12,5 cm, 5"

Fremdkörperinstrumente, Meßzirkel, Kapselstanze
 Foreign- Body Instruments, Markers, Corneoscleral punch
 Instrumental para cuerpos extraños, Compás de la cápsula, Pinza para capsuloiridectom
 Strumenti per corpi estranei, Marcatori, Pinza per capsula



DIX
43542-12



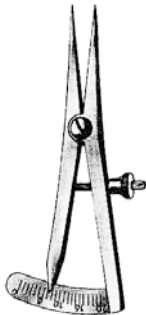
DIX
43544-12



DIX
43546-13



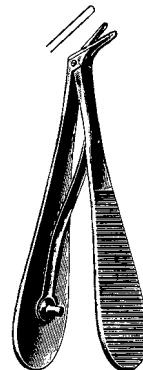
DIX
43548-13



CASTROVIEJO
43583-07 0-20 mm
7 cm, 2 3/4"



CONNIN-AMSLER
43589-13



HOLTH
43593-09
9 cm, 3 1/2"

Tränenkanaldilatatoren, Sonden Lachrymal Dilators-, Probes Dilatadores, Estiletos para canal lacrimal Dilatatori e Specilli per canale lacrimale



WILDER
43602-01



WILDER
43602-02



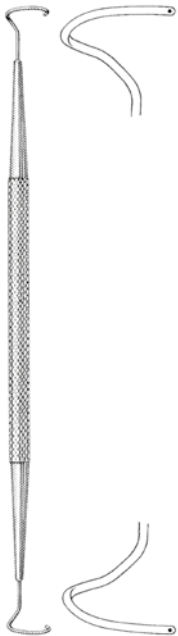
WILDER
43602-03



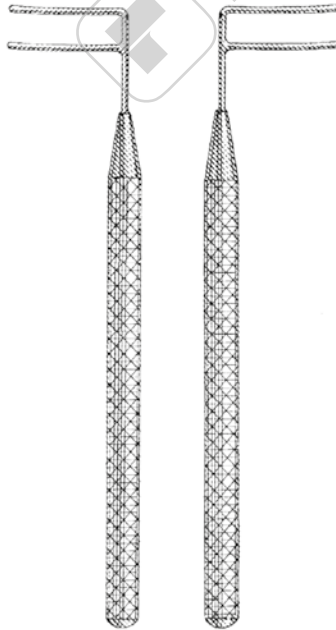
Fig. ZIEGLER
1/2 43605-12
3/4 43605-34
5/6 43605-56



CASTROVIEJO
43608-12



WORST
43609-14
14,9 cm 5 7/8"



HARMS
43610-01 43610-02
4,8 cm 1 7/8"

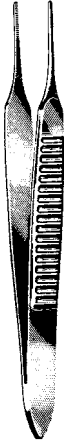
geknott



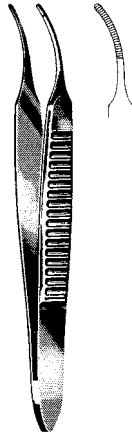
rostfrei
stainless steel
acero inoxidable
acciaio inossidabile

Fig.	BOWMAN	Ø mm
0000/000	43613-00	0,6/0,7
00/0	43614-00	0,7/0,8
0/1	43614-01	0,8/0,9
1/2	43614-12	0,9/1,1
2/3	43614-23	1,1/1,3
3/4	43614-34	1,3/1,4
4/5	43614-45	1,4/1,5
5/6	43614-56	1,5/1,6
6/7	43614-67	1,6/1,8
7/8	43614-78	1,8/1,9

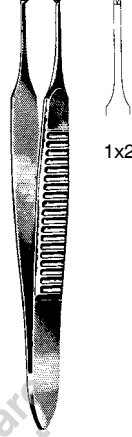
Iris Pinzetten
 Iris Forceps
 Pinzas para iris
 Pinze per iride



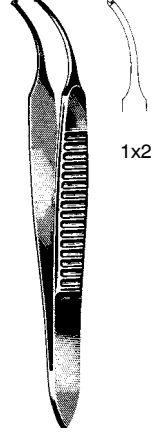
GRAEFE
 43802-07
 7 cm (2 3/4")/1 mm



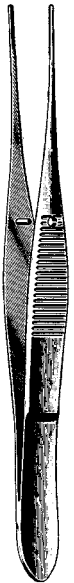
GRAEFE
 43803-07
 7 cm (2 3/4")/1 mm



GRAEFE
 43804-07
 7 cm (2 3/4")/1 mm



GRAEFE
 43805-07
 7 cm (2 3/4")/1 mm



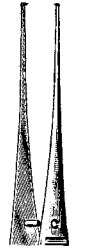
GRAEFE
 43810-10
 10 cm
 4"



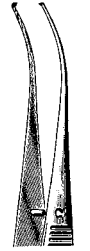
GRAEFE
 43811-10
 10 cm
 4"



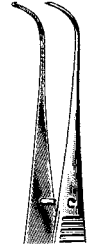
GRAEFE
 43813-10
 10 cm
 4"



GRAEFE
 43820-10
 10 cm
 4"



GRAEFE
 43821-10
 10 cm
 4"



GRAEFE
 43823-10
 10 cm
 4"

Iris Pinzetten
Iris Forceps
Pinzas para iris
Pinze per iride



STEVENS
43830-10
10,5 cm, 4.1"



STEVENS
43831-10
10,5 cm
4.1"



STEVENS
43833-10
10,5 cm
4.1"



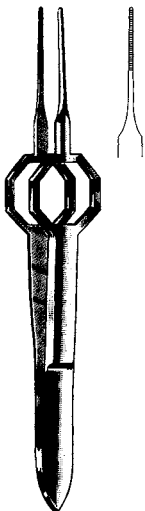
STEVENS
43840-10
10,5 cm
4.1"



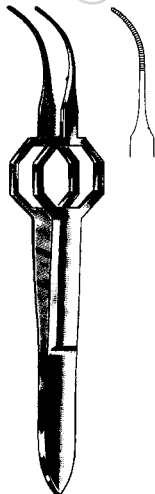
STEVENS
43841-10
10,5 cm
4.1"



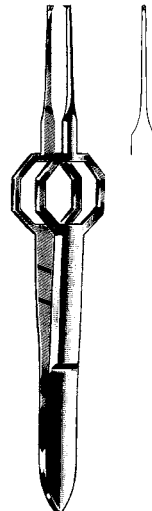
STEVENS
43843-10
10,5 cm
4.1"



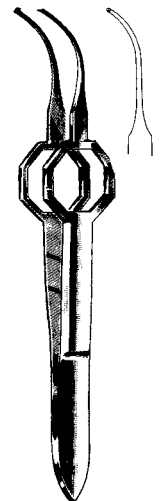
FOERSTER
43850-08
8,5 cm, 3.4"



FOERSTER
43851-08
8,5 cm, 3.4"



FOERSTER
43852-08
8,5 cm, 3.4"

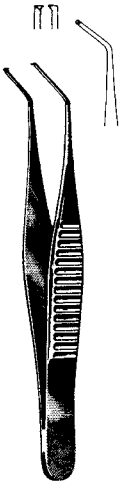


FOERSTER
43853-08
8,5 cm, 3.4"

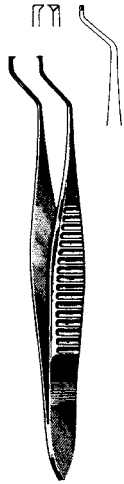
Iris Pinzetten
Iris Forceps
Pinzas para iris
Pinze per iride

seitliche Zähne
lateral teeth
dientes laterales
denti laterali

Zähne abwärts
teeth below
dientes abajo
denti in basso



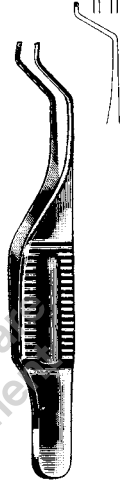
HESS
43855-07
7 cm (2 3/4")/
0,3 mm



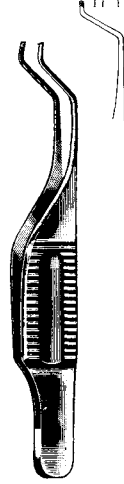
HESS
43857-07
7 cm (2 3/4")/
0,3 mm



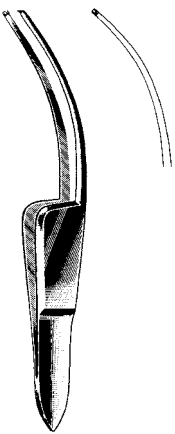
GILL
43861-07
7,5 cm (3")/
0,3 mm



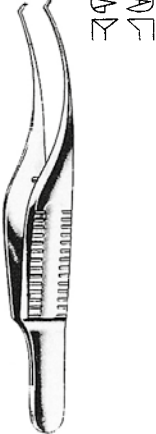
GILL-HESS
43863-07
7,5 cm (3")/
0,3 mm



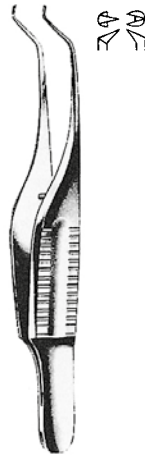
GILL-HESS
43865-07
7,5 cm (3")/
0,3 mm



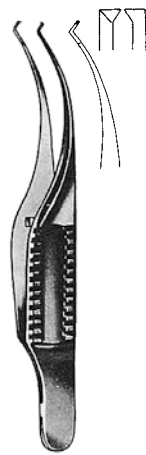
FISCHER
43869-07
7 cm (2 3/4")



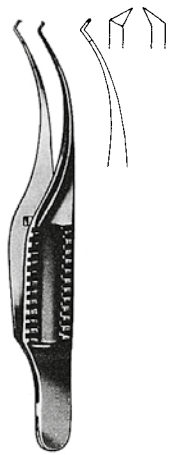
BARRAQUER-KATZIN
43881-07
7 cm (2 3/4")/0,4 mm



TROUTMAN (Colibri)
43883-07
7 cm (2 3/4")/0,12 mm

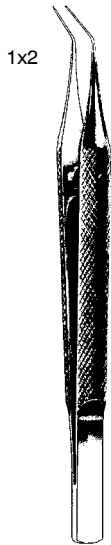


BARRAQUER (Colibri)
43885-07
7 cm (2 3/4")/0,12 mm

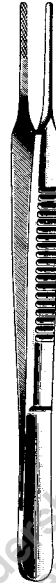


BARRAQUER (Colibri)
43887-07
7 cm (2 3/4")/0,12 mm

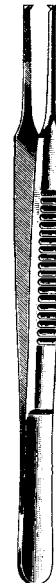
Fixierpinzette, Strabismus-Pinzetten
 Fixation forceps, Strabismus-Forceps
 Pinza para fijación, Pinzas para estrabismo
 Pinza per fissatrice, Pinze per strabismo



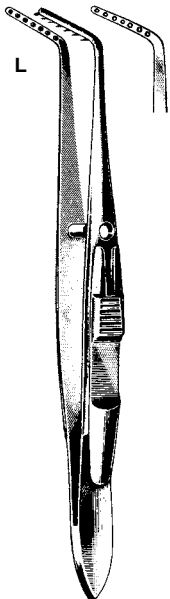
KIRBY-ARTHUR
 43891-09 9 cm, 3 1/2"
 0,2 mm



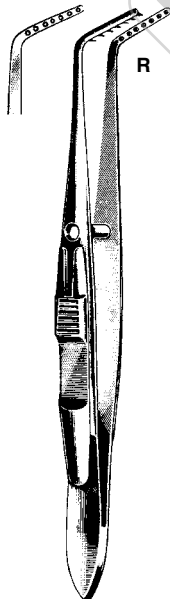
McCULLOUGH
 43902-09
 9,5 cm, 3 3/4"



McCULLOUGH
 43903-09
 9,5 cm, 3 3/4"



JAMESON
 43907-10
 10 cm, 4"



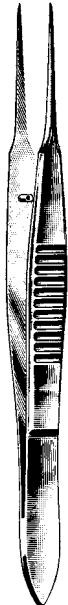
JAMESON
 43909-10
 10 cm, 4"



BONACCOLTO
 43914-10
 10 cm, 4"/1,7 mm

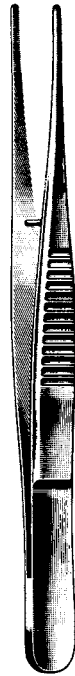


BONACCOLTO
 43916-10
 10 cm, 4"/1,2 mm



BONACCOLTO
 43920-11
 11 cm, 4 3/8"

Strabismus-Pinzetten, Iris-Pinzetten
 Strabismus-Forceps, Iris Forceps
 Pinzas para estrabismo, Pinzas para iris
 Pinze per strabismo, Pinze per iride



DASTOOR
 43924-11
 11 cm, 4 ³/₈"



DASTOOR
 43926-11
 11 cm, 4 ³/₈"



BISHOP-HARMAN
 43940-05 8,5 cm, 3.4"
 0,5 mm



BISHOP-HARMAN
 43940-08 8,5 cm, 3.4"
 0,8 mm



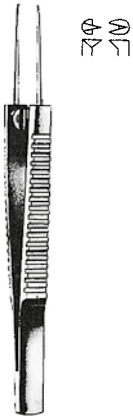
BISHOP-HARMAN
 43942-05 8,5 cm, 3.4"
 0,5 mm



BISHOP-HARMAN
 43942-08 8,5 cm, 3.4"
 0,8 mm

Iris Pinzetten, Nahtpinzetten, Muskelpinzetten
 Iris, Suture forceps, Muscle Forceps
 Pinzas para iris, Pinza para sutura, Pinzas musculares
 Pinze per iride, Pinza per sutura, muscolari

mit Führungsstift
 with guide pin
 con perno guida
 con perno di guida

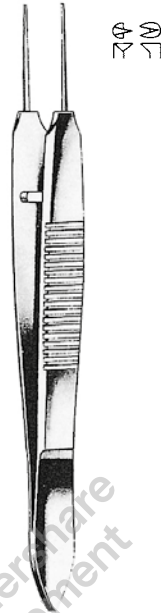


MOD. BONN
 43944-07
 7 cm, 2 3/4"
 0,12 mm

ohne Führungsstift
 without guide pin
 sin perno guida
 senza perno di guida



MOD. BONN
 43946-07
 7 cm, 2 3/4"
 0,12 mm



MOD. BONN
 43948-10
 10 cm, 4"
 0,12 mm



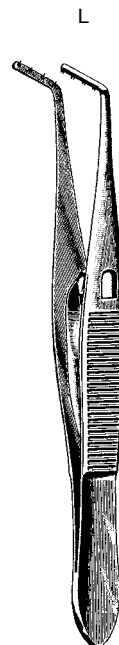
MOD. TÜBINGEN
 43950-10
 10 cm, 4"



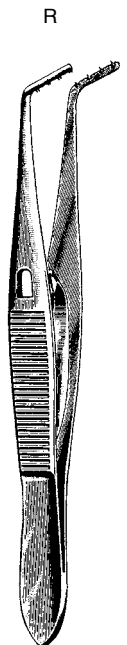
MOD. BONN
 43952-10
 10 cm, 4"/0,12 mm



MOD. TÜBINGEN
 43953-10
 10 cm, 4"



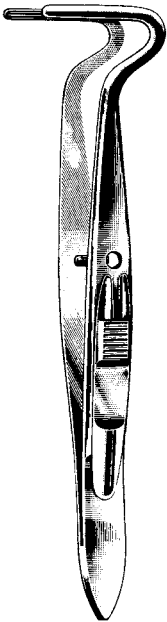
PRINCE
 43955-10
 10 cm, 4"



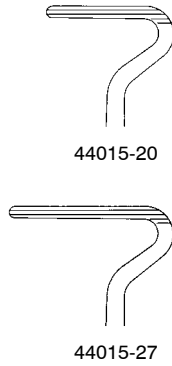
PRINCE
 43956-10
 10 cm, 4"



Muskelpinzetten, Fixationspinzetten
Muscle Forceps, Fixation Forceps
Pinzas musculares, Pinzas para fijación
Pinze muscolari, Pinze per fissaggio



BERKE
44015-20 - 44015-27
10 cm, 4"



1x2
TROUTMAN
44017-08 8,5 cm, 3.4"
0,8 mm



ELSCHMIG
44046-11
11 cm, 4 3/8"



GRAEFE
44050-11 - 44052-11
11 cm, 4 3/8"



44050-11



44052-11
mit Sperre
with catch
con cierre
c. cremagliera



LESTER
44054-09
9 cm, 3 1/2"

Fixierpinzetten, Kapselpinzette
 Fixation forceps, capsular forceps
 Pinzas para fijación, Pinzas capsulares
 Pinze fissatrici, Pinze per capsulari

1x1



CASTROVIEJO
 44066-09
 9 cm, 3 1/2"

1x1



CASTROVIEJO
 44067-09
 9 cm, 3 1/2"

2x2

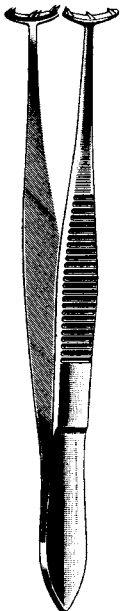


CASTROVIEJO
 44068-09
 9 cm, 3 1/2"

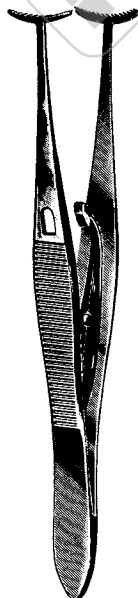
2x2



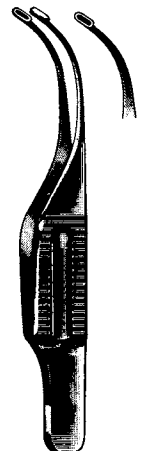
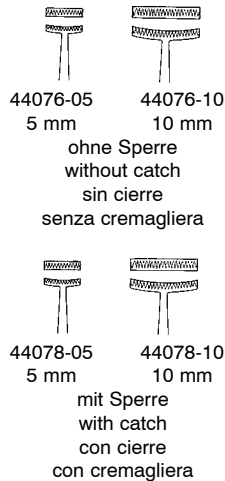
CASTROVIEJO
 44069-09
 9 cm, 3 1/2"



BARRAQUER
 44074-10
 10 cm, 4"



GREEN
 44076-05 - 44078-10
 10 cm, 4"



GILL-ARRUGA
 44101-07
 7,5 cm, 3"

Kapselpinzetten
Capsular Forceps
Pinzas capsulares
Pinze capsulare



TERSON
44103-09
9 cm, 3 1/2"



KALT
44106-10
10 cm, 4"



ELSCHNIG
44109-10
10 cm, 4"



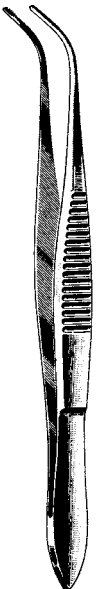
ARRUGA
44111-10
10 cm, 4"



ARRUGA
44114-10
10 cm, 4"



CASTROVIEJO
44115-10
10 cm, 4"



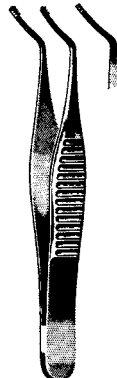
SCHWEIGGER
44117-10
10 cm, 4"



SCHWEIGGER
44119-10
10 cm, 4"



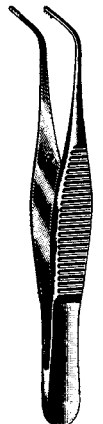
ELSCHNIG
44121-10
10 cm, 4"



HESS
44125-06
6 cm, 2.4"



HESS
44127-06
6,5 cm, 2.6"



FUCHS
44129-07
7 cm, 2 3/4"

Nahtpinzetten, Fadenpinzetten
Suture Forceps, Tying Forceps
Pinzas para suturas y hilo
Pinze per sutura, Pinze per filo

1x2



CASTROVIEJO

- 10 cm, 4"
44150-01 0,12 mm
44150-03 0,30 mm
44150-05 0,50 mm
44150-10 1,00 mm
44150-15 1,50 mm

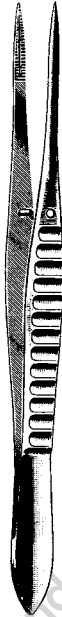
1x2



CASTROVIEJO

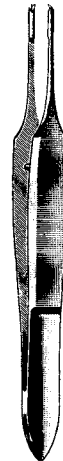
- 10 cm, 4"
44151-05
44151-10
44151-15

Zahn
tooth
diente
dente



MOORFIELD

- 44164-10
10 cm, 4"



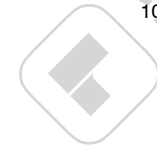
St. MARTIN

- 44166-07
7 cm, 2 3/4"



Mod. TÜBINGEN

- 44181-10
10 cm, 4"



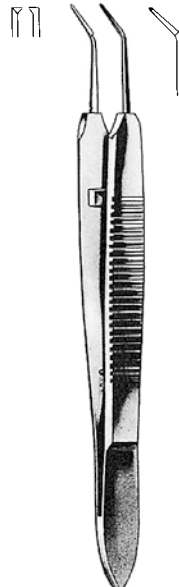
1x2



PAUFIQUE
44190-08
8,5 cm, 3.4"



PAUFIQUE
44202-08
8,5 cm, 3.4"

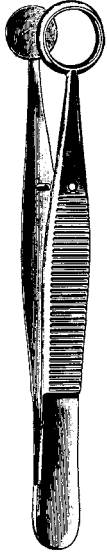


McPHERSON
44210-10
10 cm, 4"

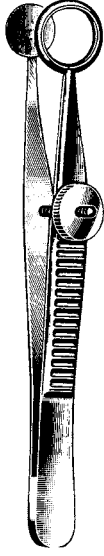


McPHERSON
44220-10
10 cm, 4"

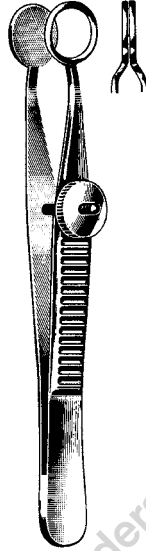
Pinzetten für Chalazion und Trachom
 Forceps for Chalazion and Trachoma
 Pinzas de chalazión y para tracoma
 Pinze per calazio e per trichiasi



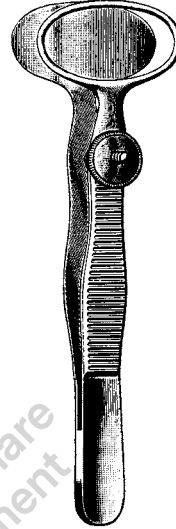
AYER
 44240-09
 9 cm, 3 1/2"



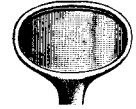
AYER
 44242-09
 9 cm, 3 1/2"



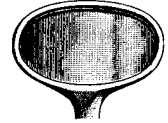
LAMBERT
 44246-09
 9 cm, 3 1/2"



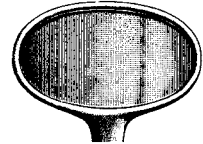
DESMARRES
 44254-09 - 44258-09
 9 cm, 3 1/2"



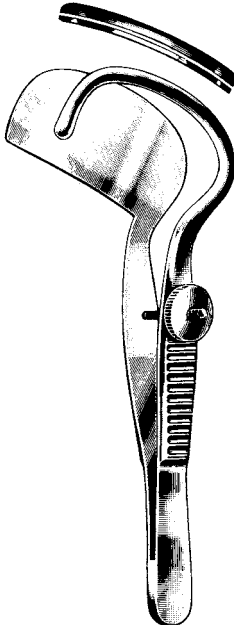
44254-09 20 mm
 Fig. 1



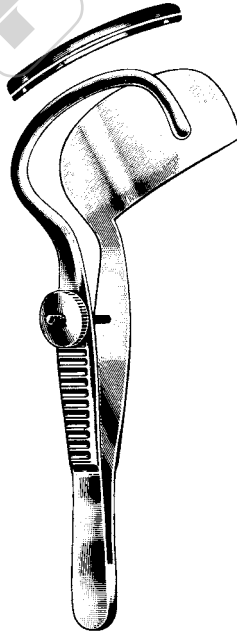
44256-09 24 mm
 Fig. 2



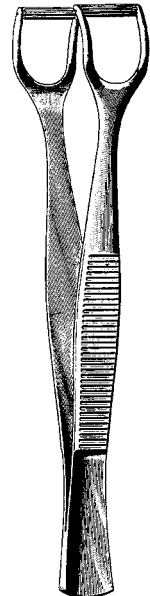
44258-09 32 mm
 Fig. 3



SNELLEN
 44265-10 10 cm, 4"

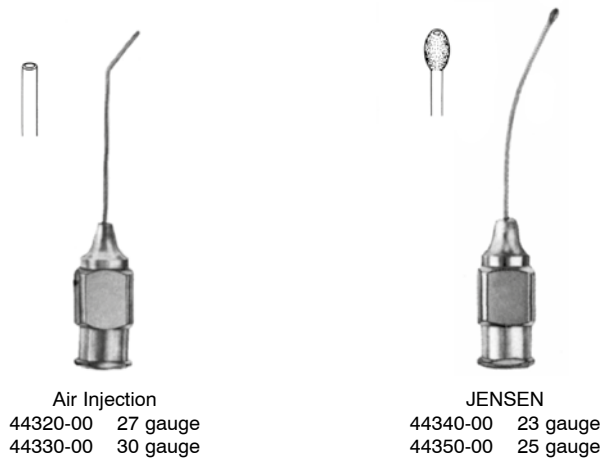
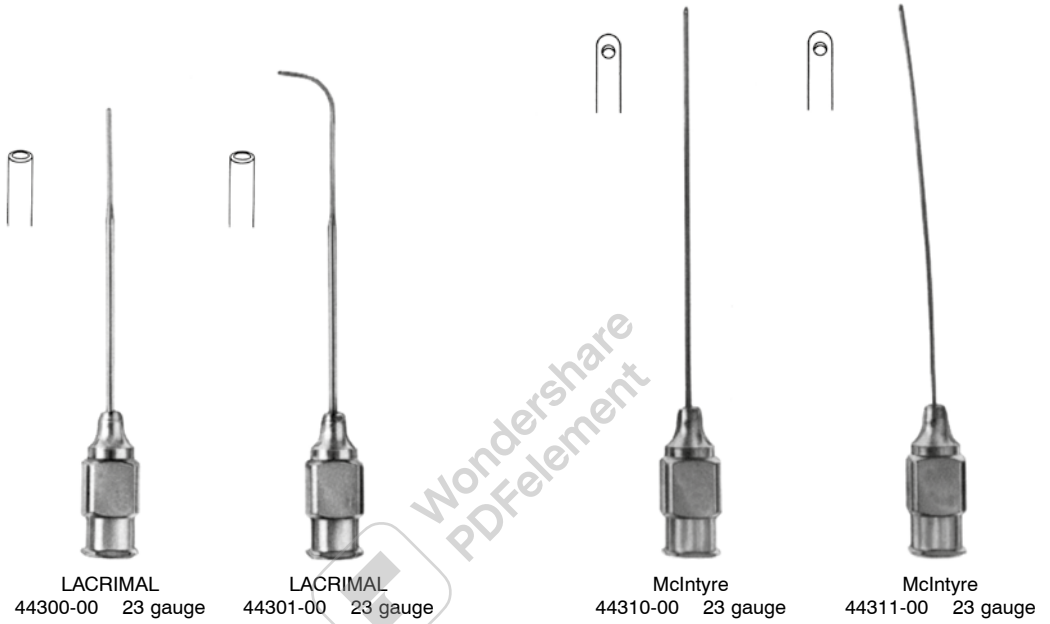


SNELLEN
 44267-10 10 cm, 4"



KNAPP-LUER
 44274-11 11 cm, 4 3/8"

Augenkanülen
Eye Cannulas
Cánulas oculares
Cannule oculistiche



Spül- und Saugkanülen, Augenkanülen
Irrigation and Aspiration Cannulas, Eye Cannulas
Cánulas de irrigación y aspiración, Cánulas oculares
Cannule per irrigazione ed aspirazione, Cannule oculistiche



BISHOP-HARMON

44370-00 komplett / complete

44371-00 Silikonball / silicone bulb

44372-00 Adapter / adaptor

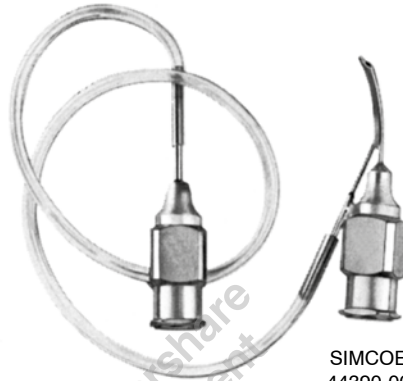
44373-00 19 gauge Kanüle / cannula

44374-00 21 gauge Kanüle / cannula

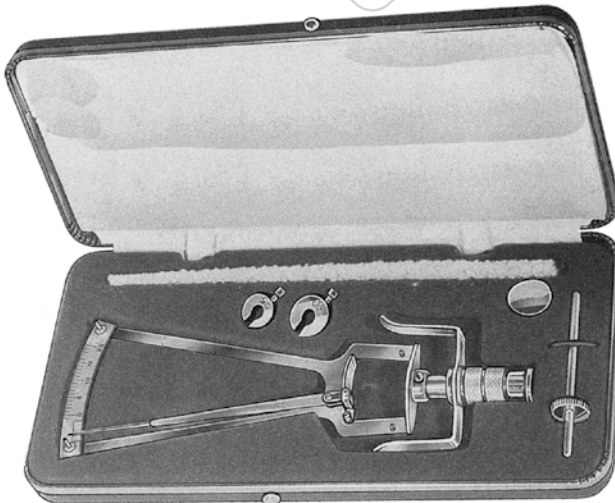
Augenkanülen, Tonometer
 Eye Cannulas, Tonometer
 Cánulas oculares, Tonómetro
 Cannule oculistiche, Tonometro



SHEETS
44380-00



SIMCOE
44390-00



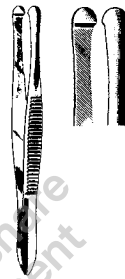
	SCHIÖETZ	
	44404-00	44406-00
Skala	gerade	schräg
scale	straight	oblique
escala	recta	oblicua
scala	retta	obliqua

44404-00 G	geeicht
44406-00 G	calibrated
	calibrado
	calibrato

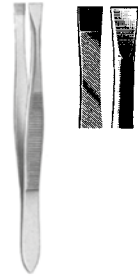
Augenmagnet, Cilienpinzetten
 Eye Magnet, Cilia Forceps
 Imàn para cuerpos extraños, Pinzas depilatorias
 Calamita per corpi estranei, Pinze depilatorie



HADEO
44408-00



BEER
44420-09
9 cm, 3 1/2"



DOUGLAS
44422-09
9 cm, 3 1/2"



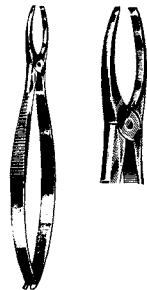
LITTAUER
44424-08
8,5 cm, 3,4"



BARRAQUER
44425-10
10,5 cm, 4,1"



HADEO
44426-09
9 cm, 3 1/2"



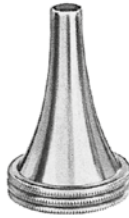
GRADLE
44428-09
9,5 cm, 3 3/4"







Ohrspekula Ear Specula Espéculos auriculares Specoli auricolari



POLITZER
45009-00
Set = 3

Innen Ø
○ = 2,0 mm
45009-02

○ = 3,0 mm
45009-03

○ = 4,0 mm
45009-04



HARTMANN
45010-00
Set = 4

Innen Ø
○ = 2,0 mm
45010-20

○ = 3,0 mm
45010-30

○ = 4,5 mm
45010-45

○ = 5,5 mm
45010-55

○ = 6,5 mm
45010-65

○ = 7,5 mm
45010-75



HARTMANN
45011-00
Set 3-7 mm

schwarz
black
negro
nero

Innen Ø
○ = 2,0 mm
45011-03

○ = 3,5 mm
45011-04

○ = 5,0 mm
45011-05

○ = 6,5 mm
45011-07

○ = 7,5 mm
45011-08



TOYNBEE
45012-00
Set = 3

Innen Ø
○ = 4,0 mm
45012-40

○ = 5,5 mm
45012-55

○ = 6,5 mm
45012-65

○ = 7,5 mm
45012-75



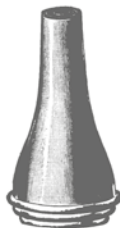
GRUBER, rund
45014-00
Set = 4

Innen Ø
○ = 4,5 mm
45014-45

○ = 5,5 mm
45014-55

○ = 6,5 mm
45014-65

○ = 7,5 mm
45014-75

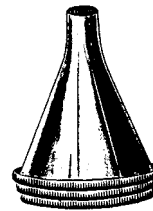


GRUBER, oval
45015-00
Set = 3

Innen Ø
○ = 4,5 mm
45015-45

○ = 5,5 mm
45015-55

○ = 6,5 mm
45015-65



BOUCHERON
45018-00
Set = 4

Innen Ø
○ = 5,0 mm
45018-50

○ = 6,0 mm
45018-60

○ = 7,0 mm
45018-70

○ = 8,0 mm
45018-80

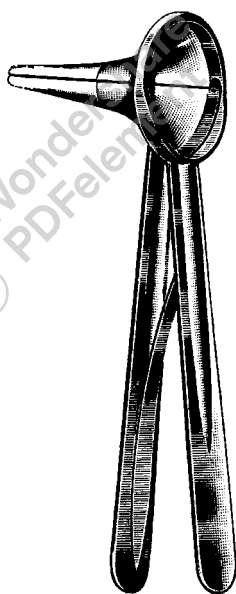
Ohrspekula
Ear Specula
Espéculos auriculares
Specoli auricolari

○
45020-01
Ø 3 mm

○
45020-02
Ø 4 mm

○
45020-03
Ø 5 mm

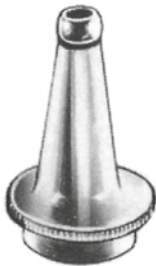
○
45020-04
Ø 6 mm



RICHNAU-HOLMGREN

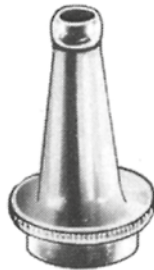
Ohrspekula
Ear Specula
Espéculos auriculares
Specoli auricolari

6,5 mm



45030-06

7,5 mm



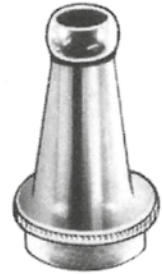
45030-07

8,2 mm

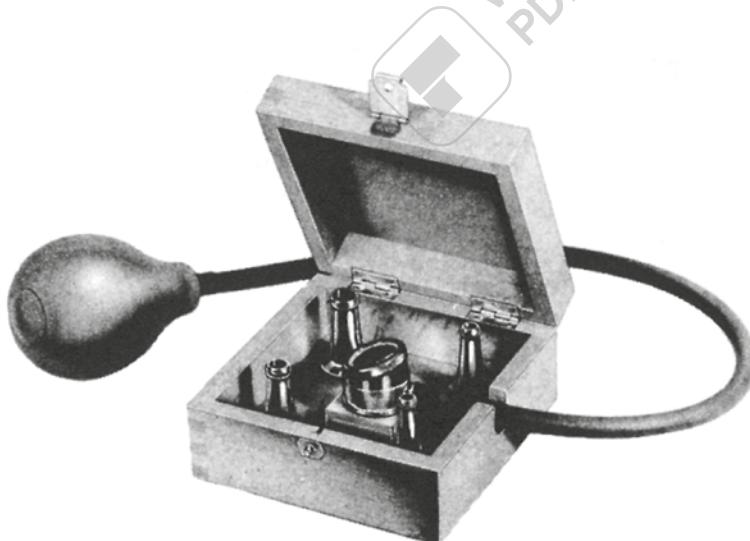


45030-08

10 mm



45030-10



BRUENINGS
45030-04

45030-04

Komplett bestehend aus:
4 Spekula, Saugkammer mit
Gebläse, Holzetui

Complete consisting of:
4 specula, suction head and rubber
tube with bulb, wooden case

Compuesto de:
4 espéculos, cámara de aspiración,
insuflador de goma, en estuche de
madera

Composta da:
4 specoli, camera aspirante con
soffiatrice, scatola di legno

Ersatzteile / spare parts /
repuestos / pezzi di ricambio

45036-09

Lupe / Magnification glass /
lupa / lente d'ingrandimento

45036-10

Saugpumpe / rubber ball /
pera de goma / soffiatrice di gomma

Ohrspekula
Ear Specula
Espéculos auriculares
Specoli auricolari



6,5 mm Ø



45036-06



7 mm Ø



45036-07



8 mm Ø



45036-08



SIEGLE
45036-03

45036-03

Komplett bestehend aus:
Ohrspekulum, 3 Spekula, 1 Gebläse

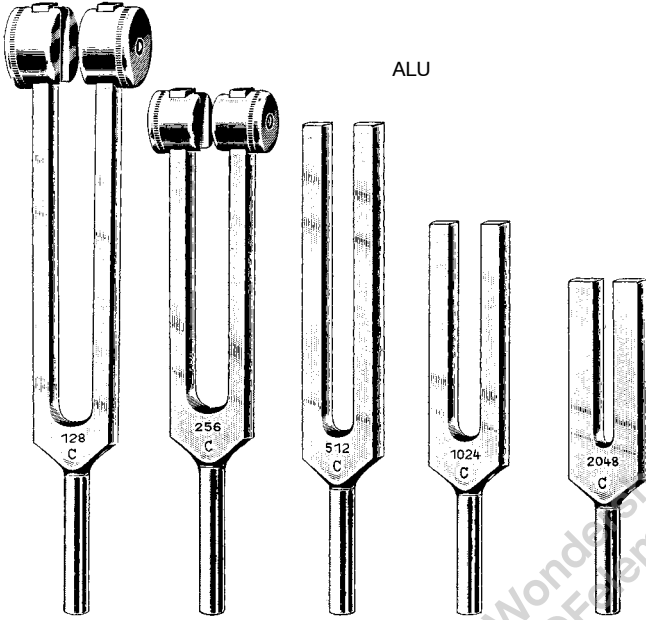
Complete consisting of:
Ear Specula, 1 rubber tube with bulb

Compuesto de:
Otoscopio con 3 espéculos, insuflador y tubo

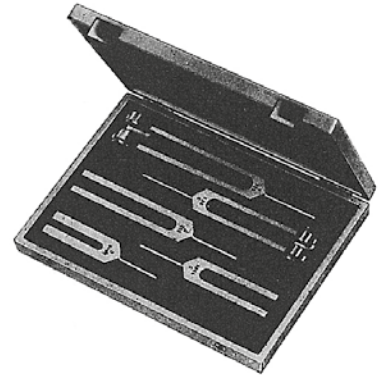
Composta da:
Otoscopio con 3 specoli e 1 insufflatore con tubo

Stimmgabeln
Tuning Forks
Diapasones
Diapason

ALU

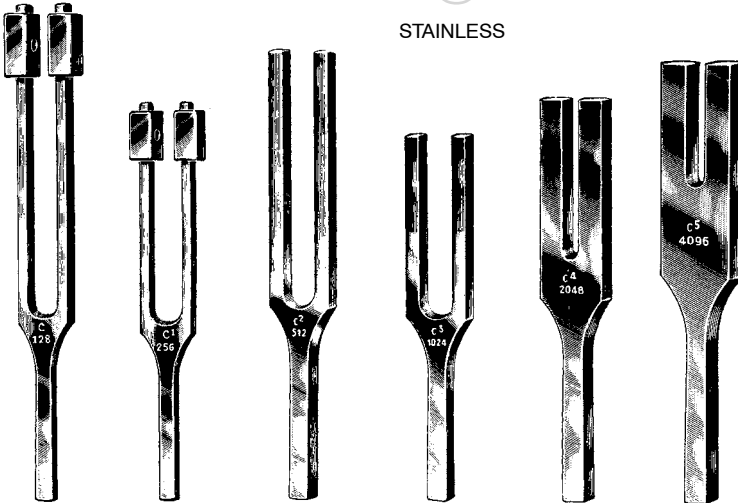


45060-01 C 128
45060-02 C' 256
45060-03 C² 512
45060-04 C³ 1024
45060-05 C⁴ 2048

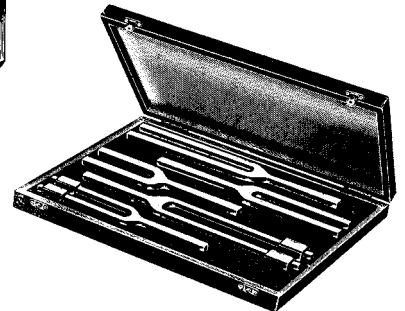


45061-00
compl.

STAINLESS



45070-01 C 128
45070-02 C' 256
45070-03 C² 512
45070-04 C³ 1024
45070-05 C⁴ 2048
45070-06 C⁵ 4096

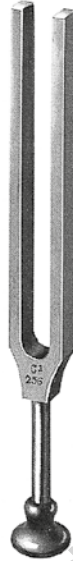


HARTMANN
45071-00
compl.

Stimmgabeln
Tuning Forks
Diapasones
Diapason



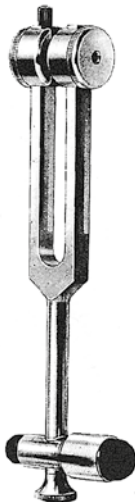
45072-01
a¹ 440



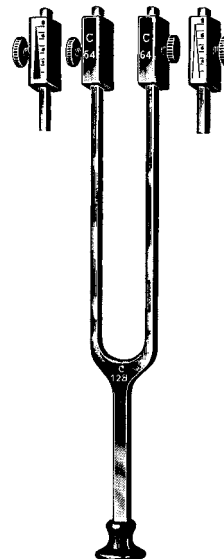
LUCAE
45073-01 C¹ 128
45073-02 C¹ 256
45073-03 C² 512
45073-04 C³ 1024
45073-05 C⁴ 2048
45073-06 C⁵ 4096



LUCAE
45074-01
C 128



45075-00

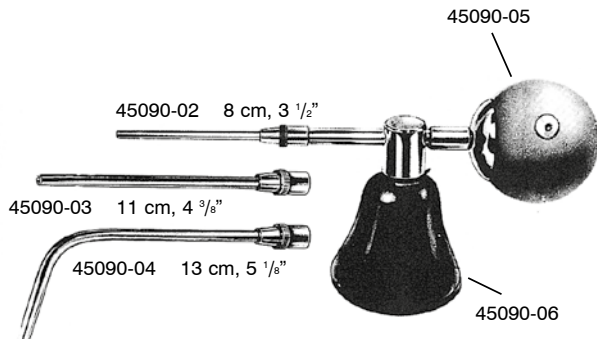


RYDEL-SEIFFERT
45076-01 C 128 / C 64

Lärmtrommel, Pulverbläser
Noise Apparatus, Powder Blowers
Ensordecedor, Lanzapolvero
Assorditore, Insoffiatori per polvere



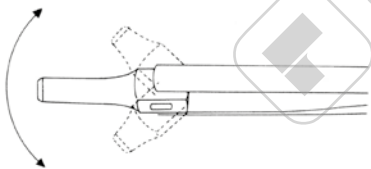
BARANY
45080-00



KABIERSKE

45090-00 30 ccm

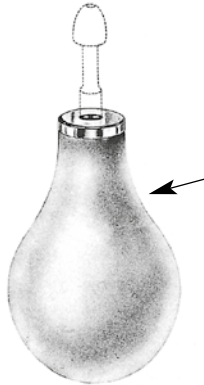
komplett mit 3 Kanülen und Gummiball
complete with 3 cannulas and rubber bulb
completo con 3 cánulas y pera de goma
completo con 3 cannule e pera di gomma



UNIVERSAL
45090-08

Komplett mit beweglicher Düse,
Schraubflasche 30 ccm und Halbgebläse
complete with movable tube, screw bottle
30 ccm and rubber bulb
completo con tubo móvil botella con rosca
30 ccm y pera de goma
completo con tubo mobile, bottiglia con
filettatura 30 ccm e pera di insufflazione

Luftdusche, Ohrspritze
Air Bag, Ear Syringe
Insuflador de aire, Jeringa
Insoffiatore d'aria, Siringa Auricolare



45091-02
Gummibirne alleine
Rubber bulb only
Pera de goma, sola
Pera di gomma, sola

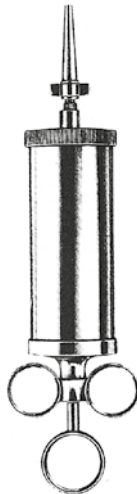


45091-03

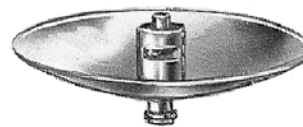
45091-04
4 mm Ø45091-15
15 mm Ø45091-17
17 mm Ø45091-22
22 mm Ø

POLITZER
45091-00 Set
incl.
45091-03
45091-15
45091-17
45091-22

POLITZER
45091-01 Set
incl.
45091-03
45091-04
45091-15
45091-17
45091-22



ml REINER
50 45096-50
75 45096-75
100 45097-10
150 45097-15



45097-01



45097-02



45097-03

Spritze, Küretten
 Syringe, Currettes
 Jeringa, Curetas
 Siringa, Curette



45098-01	1 ml	45099-01	1 ml
45098-02	2 ml	45099-02	2 ml
45098-05	5 ml	45099-05	5 ml
45098-10	10 ml	45099-10	10 ml
45098-20	20 ml	45099-20	20 ml
45098-50	50 ml	45099-50	50 ml

	Innen Ø	1.5 mm	1.9 mm	2.5 mm	2.7 mm	3.4 mm	4.0 mm	4.5 mm
Küretten Currettes Curetas Curette								
		Fig. 00	0	1	2	3	4	5
stumpf blunt romas smusse		45109-00	45110-00	45110-01	45110-02	45110-03	45110-04	45110-05
scharf sharp cortantes taglianti		45111-00	45112-00	45112-01	45112-02	45112-03	45112-04	45112-05
stumpf blunt romas smusse		45114-00	45115-00	45115-01	45115-02	45115-03	45115-04	45115-05
scharf sharp cortantes taglianti		45116-00	45117-00	45117-01	45117-02	45117-03	45117-04	45117-05

BUCK

14,5 cm, 5 3/4"

Ohrkatheter, Parazentese Nadeln, Ohrmesser
 Catheters, Paracentesis Needles, Ear Knives
 Cateteres, agujas para paracentesis, Cuchillos auriculares
 Cateteri, Aghi per paracentesi, Coltelli auricolari

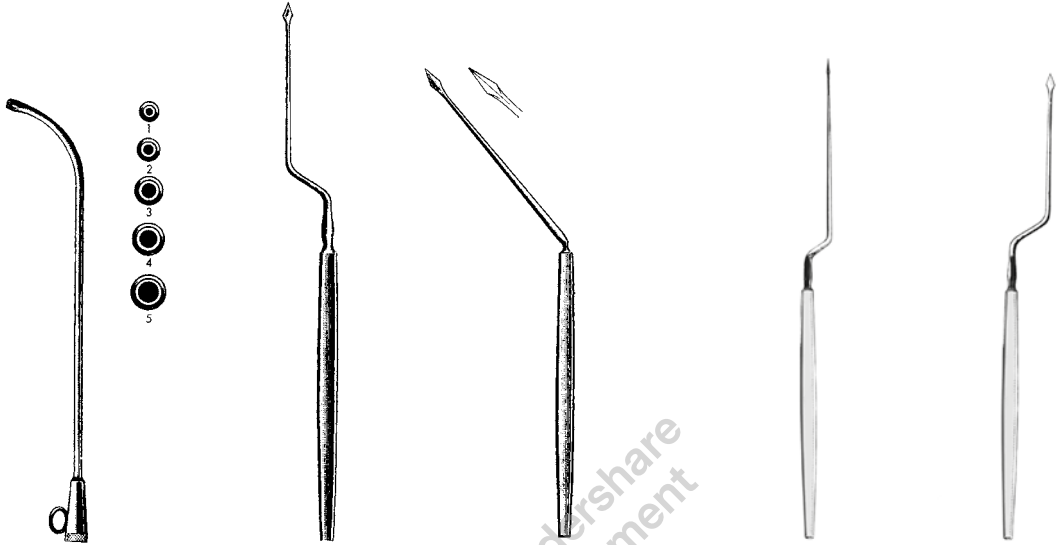


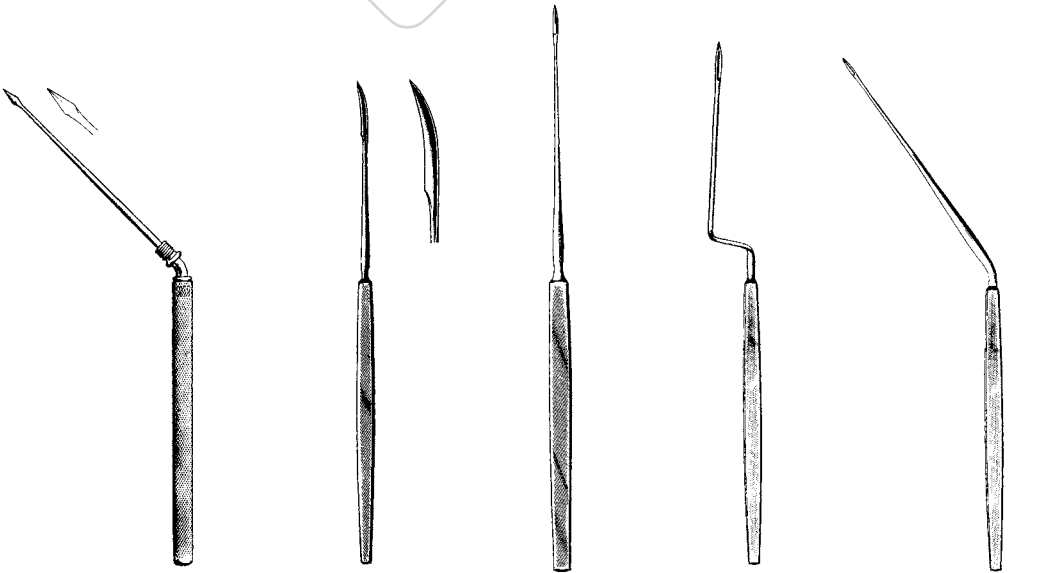
Fig. HARTMANN
 1 45133-01 3,5 mm
 2 45133-02 4,0 mm
 3 45133-03 4,5 mm
 4 45133-04 5,0 mm
 5 45133-05 6,0 mm

POLITZER
 45150-18
 18 cm, 7"

POLITZER
 45151-16
 16,5 cm, 6 1/2"

LUCAE
 45152-01
 18 cm, 7"

LUCAE
 45152-02
 18 cm, 7"



POLITZER
 45153-16
 16 cm, 6 1/4"

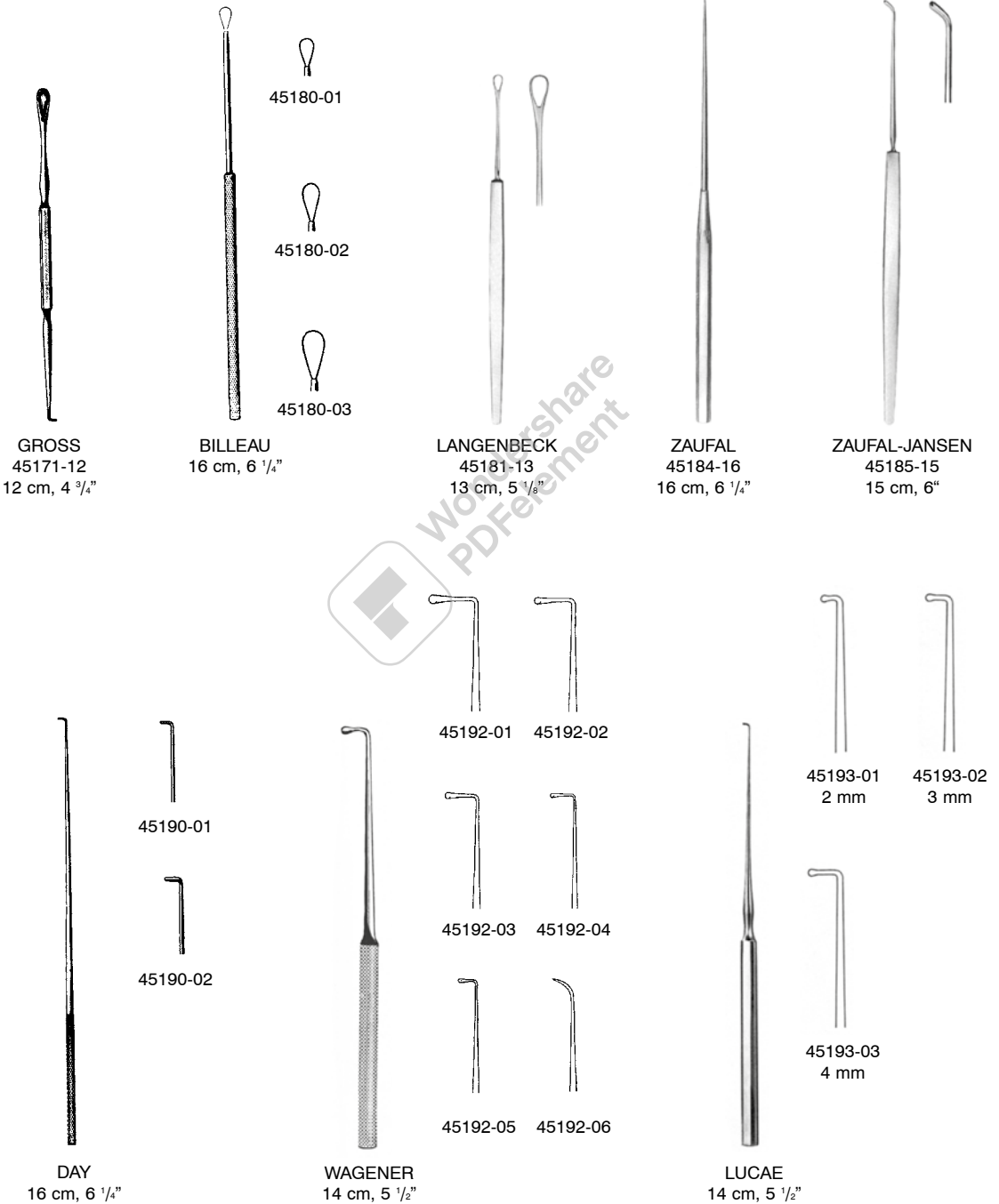
POLITZER
 45160-15
 15 cm, 6"

SEXTON
 45162-18
 18 cm, 7"

SEXTON
 45164-17
 17 cm, 6 3/4"

SEXTON
 45165-17
 17 cm, 6 3/4"

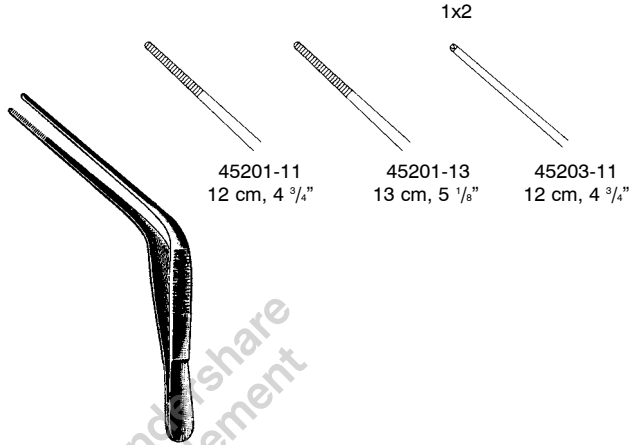
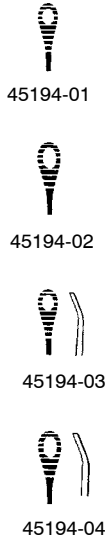
Löffel, Schlingen, Häkchen
Ear spoons, Loops, Hooklets
Cucharas, Asas, Ganchitos
Cucchiai, Anse, Uncinetti



Schlingen, Pinzetten
 Loops, Dressing Forceps
 Asas, Pinzas
 Anse, Pinze



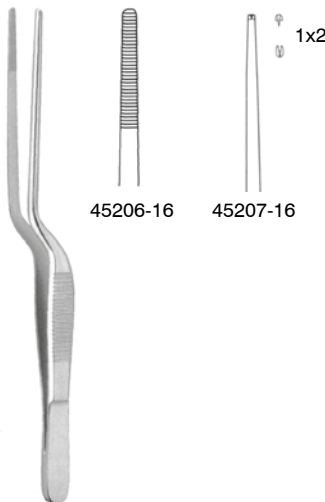
SHAPLEIGH
 13 cm, 5 1/8"



WILDE (TROELTSCH)



LUCAE
 45206-14
 14 cm, 5 1/2"



LUCAE
 16 cm, 6 1/4"

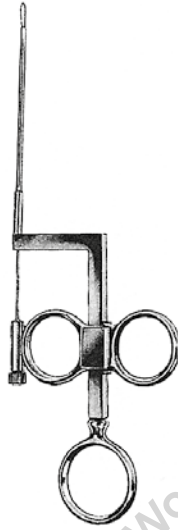


COTTLE
 45208-14
 14 cm, 5 1/2"

Polypenschnürer, Ohrzängchen
Snare, Ear Forceps
Cierra-nudos, Pinzas auriculares
Serranodi, Pinze auricolari



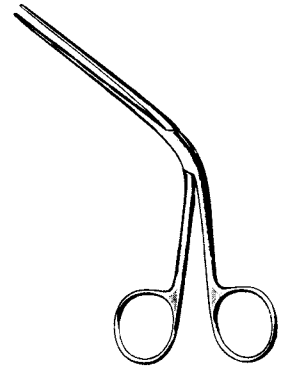
KRAUSE
45220-16
16 cm, 6 1/4"



WILDE
45222-17
17 cm, 6 3/4"



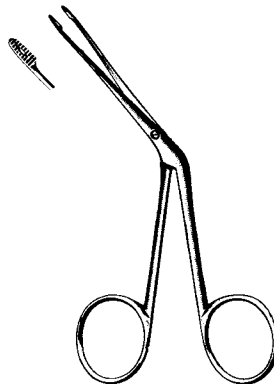
45225-02
doz./doc./dozz.
0,2 mm



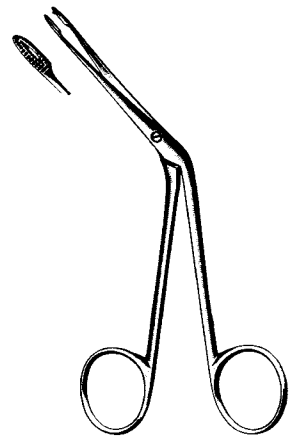
TILLEY
45243-14
14 cm, 5 1/2"



LITTAUER
45245-12
12 cm, 4 3/4"



HARTMANN
45246-12
12 cm, 4 3/4"

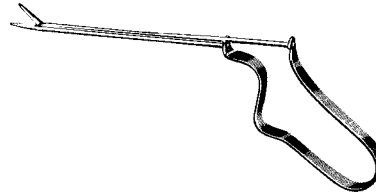


HARTMANN
45246-14
14 cm, 5 1/2"

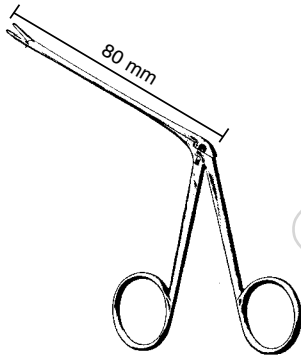
Fremdkörperheber, Fremdkörperzängchen
Foreign Body Levers, Ear Polypus Forceps
Elevadores para cuerpos extraños, Pinzas para pólipos
Leve per corpi estranei, Pinze per polipi



QUIRE
45251-10
10 cm, 4"



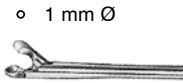
BUCK
45253-11
11 cm, 4 3/8"



45255-08 - 45275-08



HARTMANN-WULLSTEIN
45255-08
8,5 cm, 3.4"



HARTMANN-WULLSTEIN
45257-08
8,5 cm, 3.4"



HARTMANN
45261-08 8,5 cm, 3.4"
45261-14 14,0 cm, 5 1/2"
45261-16 16,0 cm, 6 1/4"



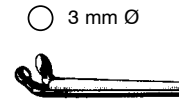
HARTMANN
45263-08 8,5 cm, 3.4"
45263-14 14,0 cm, 5 1/2"



HARTMANN
45265-08
8,5 cm, 3.4"



Ø mm HARTMANN
2,0 45267-20 8,5 cm, 3.4"
2,5 45267-25 8,5 cm, 3.4"
3,0 45267-30 8,5 cm, 3.4"



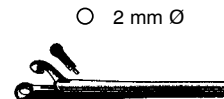
HARTMANN
45269-30
8,5 cm, 3.4"



STRUEMPEL
45271-08 8,5 cm, 3.4"
2,5x5 mm

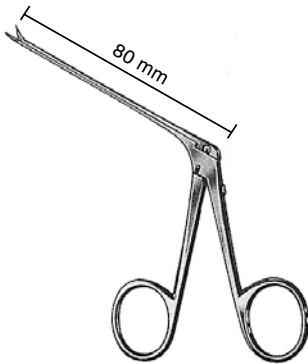


HARTMANN
45273-08
8,5 cm, 3.4"



HARTMANN-HOFFMANN
45275-08
8,5 cm, 3.4"

Mikro-Ohrscheren, Mikro-Ohrzangchen
 Micro Ear Scissors, Micro Ear Forceps
 Tijeras auriculares micro, Pinzas auriculares micro
 Forbici auricolari micro, Pinze auricolari micro



45310-40 - 45322-70



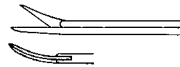
A
 BELLUCCI
 45310-40
 micro mini
 4 mm



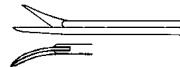
A
 BELLUCCI
 45312-55
 micro standard
 5,5 mm



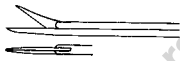
D
 BELLUCCI
 45313-55
 micro standard
 5,5 mm



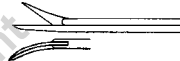
B
 BELLUCCI
 45315-55
 micro standard
 5,5 mm



C
 BELLUCCI
 45317-55
 micro standard
 5,5 mm



A
 SHEA
 45320-70
 7,0 mm



C
 SHEA
 45321-70
 7,0 mm



B
 SHEA
 45322-70
 7,0 mm

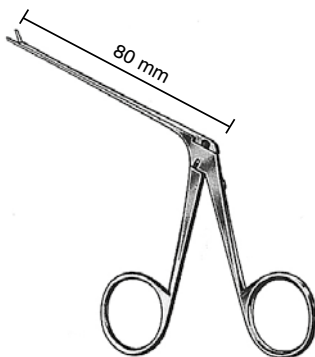
A: gerade / straight / recta / retta

B: rechts / right / derecha / destra

C: links / left / izquierda / sinistra

D: aufgebogen / curved up / curva in alto / curva hacia arriba

E: nach unten gebogen / curved down / curva in basso / curva hacia abajo



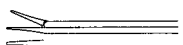
45350-40 - 45360-35



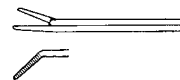
A
 45350-40
 4 mm



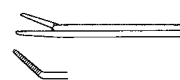
A
 45350-70
 7 mm



A
 45352-40
 4 mm



C
 45353-60
 6 mm



B
 45355-60
 6 mm



D
 45357-40
 4 mm



E
 45359-40
 4 mm



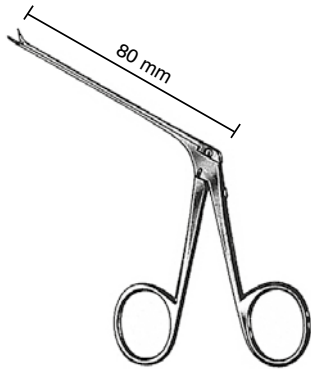
A
 45360-35
 3,5 mm

Mikro-Ohrzängchen, Hammerkopfstanze

Micro Ear Forceps, Malleus punch

Pinzas auriculares micro, Pinza saca-bocadas para cabeza de martillo

Pinze auricolari micro, Pinze taglianti per testa del martelletto taglio a scalpello

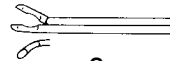


45362-45 - 45383-30



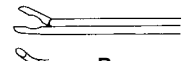
A

45362-45
4,5 mm



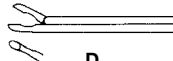
C

45363-45
4,5 mm



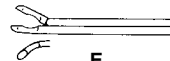
B

45365-45
4,5 mm



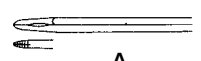
D

45367-50
5,0 mm



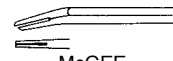
E

45369-50
5,0 mm



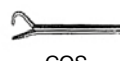
A

GREVEN
45370-50
5,0 mm



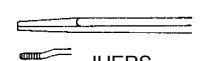
McGEE

45371-40
0,8x4,0 mm



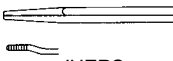
COS

45373-30
1,8x0,8x3,0 mm



JUERS

45375-60
6,0 mm



JUERS

45377-60
6,0 mm



C

HAUGH
45381-30
45° 3 mm



B

HAUGH
45383-30
45° 3 mm

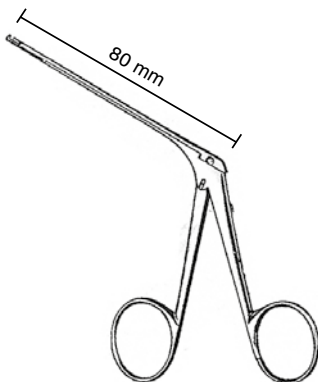
A: gerade / straight / recta / retta

B: rechts / right / derecha / destra

C: links / left / izquierda / sinistra

D: aufgebogen / curved up / curva in alto / curva hacia arriba

E: nach unten gebogen / curved down / curva in basso / curva hacia abajo



DIETER
45385-01 - 45387-02

micro ø 1,3 mm



45385-01

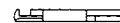
aufwärts

upward

arriba

in alto

mini ø 1,8 mm



45387-01

abwärts

downward

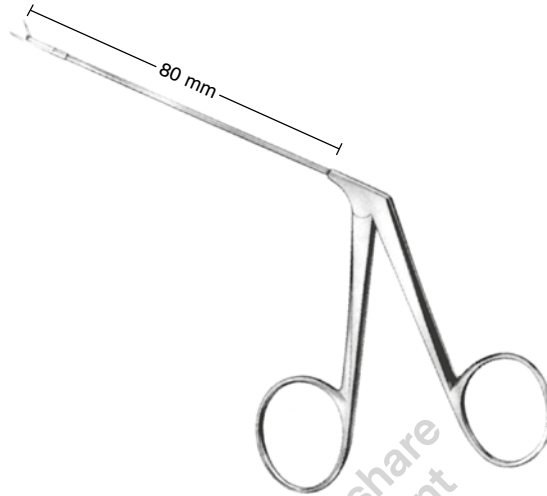
abajo

in basso

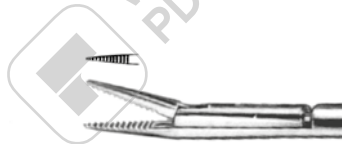


45387-02

Mikro-Ohrzangchen
Micro Ear Forceps
Pinzas auriculares micro
Pinze auricolari micro



45390-35
0,8 x 3,5 mm



45390-50
1 x 5 mm



45391-35
0,8 x 3,5 mm



45392-35
0,8 x 3,5 mm



45393-50
1 x 5 mm



45394-50
1 x 5 mm

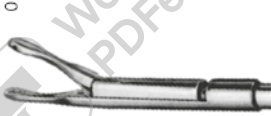
Mikro-Ohrzängchen
 Micro Ear Forceps
 Pinzas auriculares micro
 Pinze auricolari micro



WULLSTEIN



45400-01
 0,9 x 1 mm



45400-02
 0,8 x 1,3 mm



45400-03
 1 mm



45401-25
 1,7 x 2,5 mm



45402-10
 0,9 x 1 mm

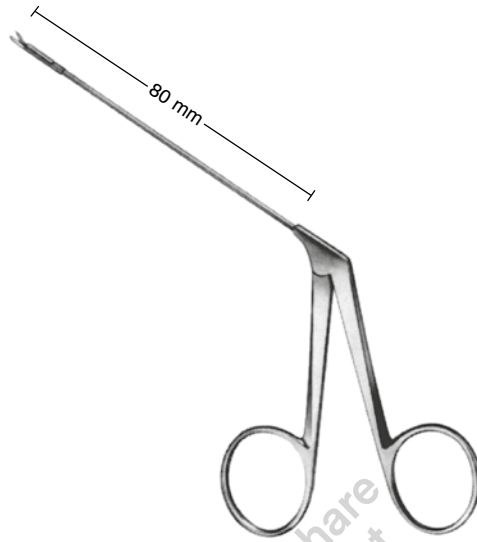


45403-13
 0,8 x 1,3 mm



45404-13
 0,8 x 1,3 mm

Mikro-Ohrscheren
Micro Ear Scissors
Tijeras auriculares micro
Forbici auricolari micro



WULLSTEIN



45410-01



45411-01



45412-01



45413-01



45414-01

Messer
Knives
Cuchillos
Coltelli



SCHUKNECHT
45701-01
16 cm, 6 1/4"



SCHUKNECHT
45701-02
16 cm, 6 1/4"



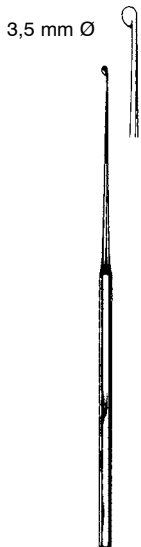
SCHUKNECHT
45703-15
15,5 cm, 6"



WULLSTEIN
45704-15
15,5 cm, 6"



TABB
45705-15
15,5 cm, 6"



PLESTER
45706-35
15,5 cm, 6"



45709-10
Ø 1,0 mm



45709-14
Ø 1,4 mm



45709-16
Ø 1,6 mm



45709-20
Ø 2,0 mm



45709-26
Ø 2,6 mm



45709-28
Ø 2,8 mm



45709-30
Ø 3,0 mm



ROSEN
45709-10 - 45709-30
16 cm, 6 1/4"

Nadeln und Häkchen Needles and Hooks Agujas y Ganchos Aghi e uncini



16 cm
6 1/4"



BARBARA
45710-15



BARBARA
45711-15



BARBARA
45713-15



BARBARA
45715-17



25°
SHAMBAUGH



45°
SHAMBAUGH



90°
SHAMBAUGH



BARBARA
45725-05=0,5 mm
45725-10=1,0 mm

mm
0,3
0,6
1,0
1,2
1,5
2,0
2,5



45730-03 - 45747-10
15,5 cm, 6"



mm
0,3
0,6
1,0

90°
45730-03
45730-06
45730-10



90°
45732-03
45732-06
45732-10



mm
0,5
1,0

McGEE
45733-05
45733-10



McGEE
45735-05
45735-10



BARBARA
45736-15
15,5 cm, 6"



ROSEN
45737-15
15,5 cm, 6"



mm
0,3
0,6
1,0

25°
45741-03
45741-06
45741-10



25°
45743-03
45743-06
45743-10

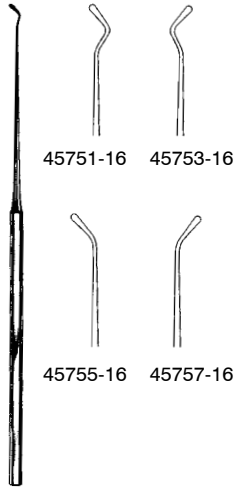


45°
45745-03
45745-06
45745-10



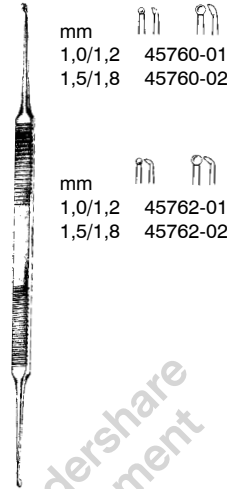
45°
45747-03
45747-06
45747-10

Dissektoren, Küretten, Elevatoren, Mikro-Meßsonde
 Dissectors, Curettes, Elevators, Micro measuring rod
 Disectores, Curetas, Elevadores, Sonda para medir
 Dissettori, Curette, Elevatori, Sonda auricolare per misurare



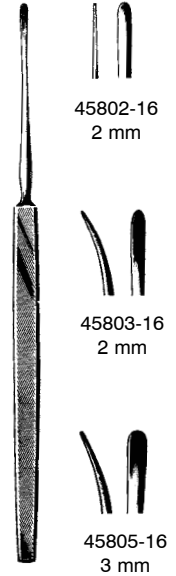
45751-16 45753-16
 45755-16 45757-16

FISCH
 45751-16 - 45757-16
 16 cm, 6 1/4"

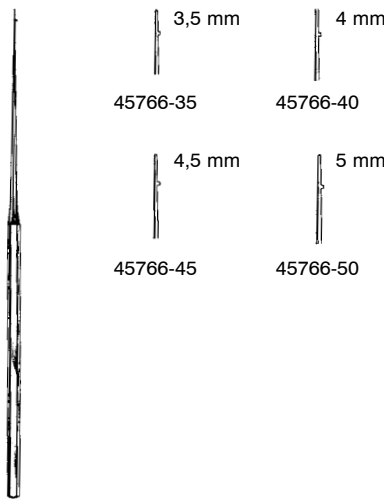


mm
 1,0/1,2 45760-01
 1,5/1,8 45760-02
 mm
 1,0/1,2 45762-01
 1,5/1,8 45762-02

HOUSE
 45760-01 - 45762-02
 15 cm, 6"



LEMPERT
 45802-16 - 45805-16
 16 cm, 6 1/4"



HOUSE
 45766-35 - 45766-50
 16 cm, 6 1/4"

6 mm

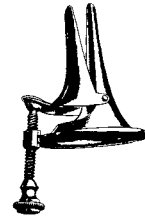
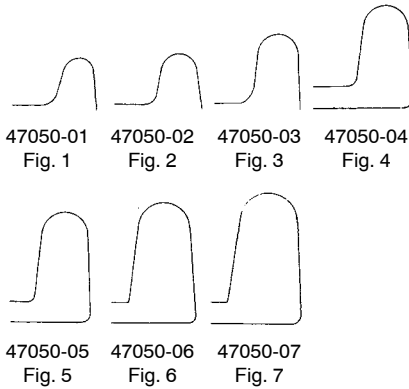


LEMPERT
 45807-20
 20,5 cm, 8"

Nasenspekula
Nasal Specula
Espéculos nasales
Specoli nasali



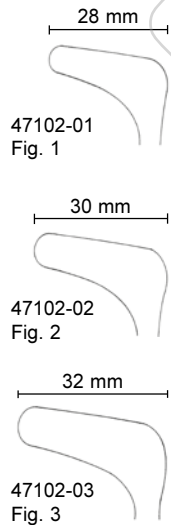
THUDICHUM
47050-01 - 47050-07



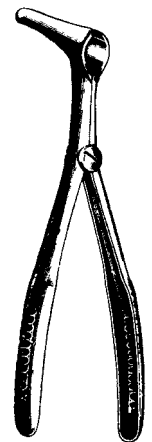
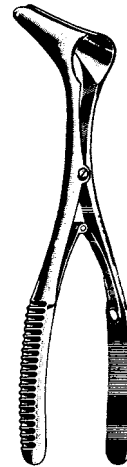
VOLTOLINI
47060-01 - 47060-03



HARTMANN-HALLE
47102-01 - 47102-03
15 cm, 6"



leichtes Modell
lightweight
mod. ligero
mod. leggero

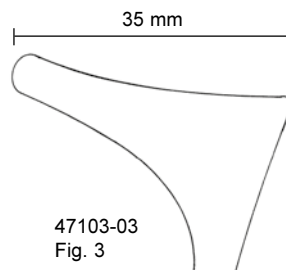
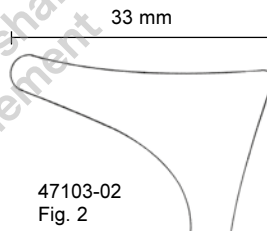
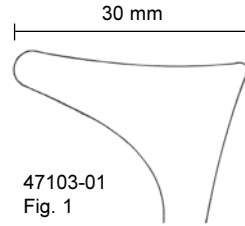


Mod. WIEN
47112-01 25 mm
Kind, child, niño, bamb. 47112-02 30 mm
Erwachs., Adult, adulto 47112-03 35 mm

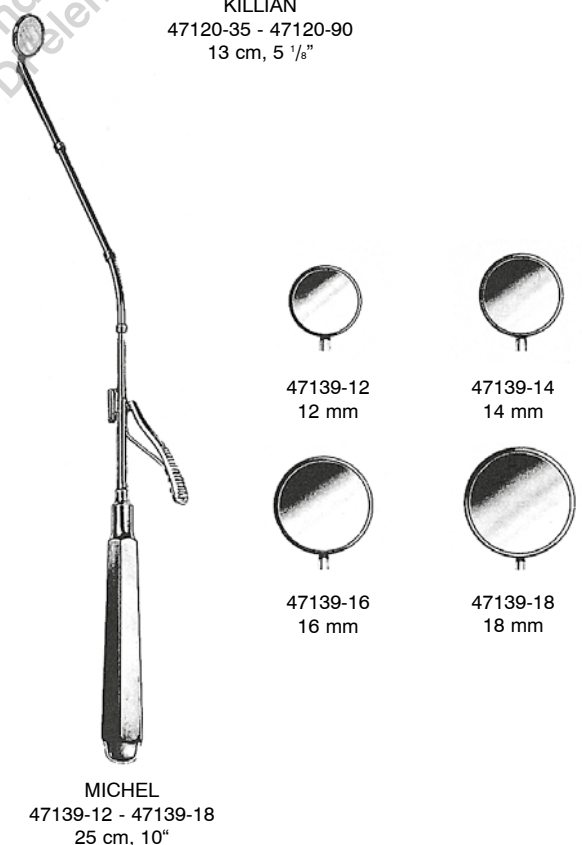
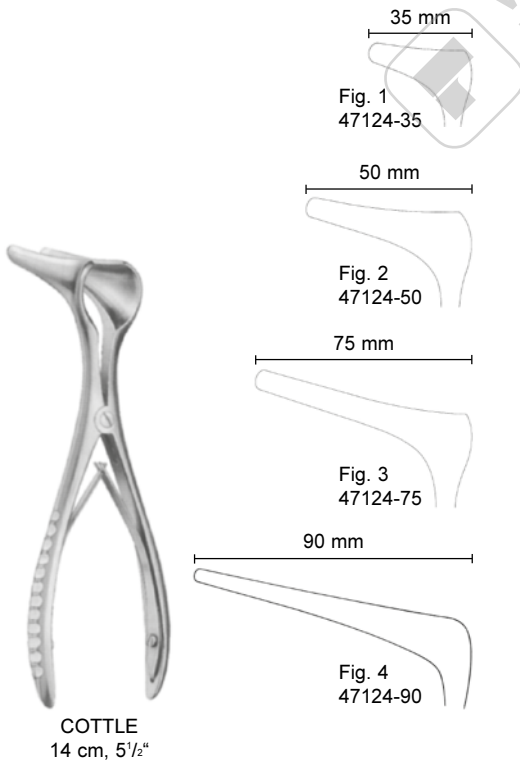
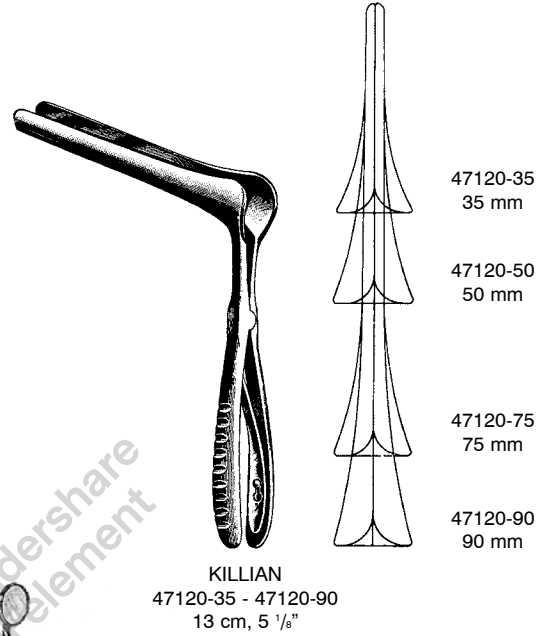
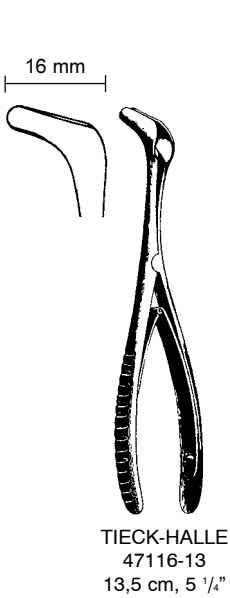
Nasenspekula
Nasal Specula
Espéculos nasales
Specoli nasali



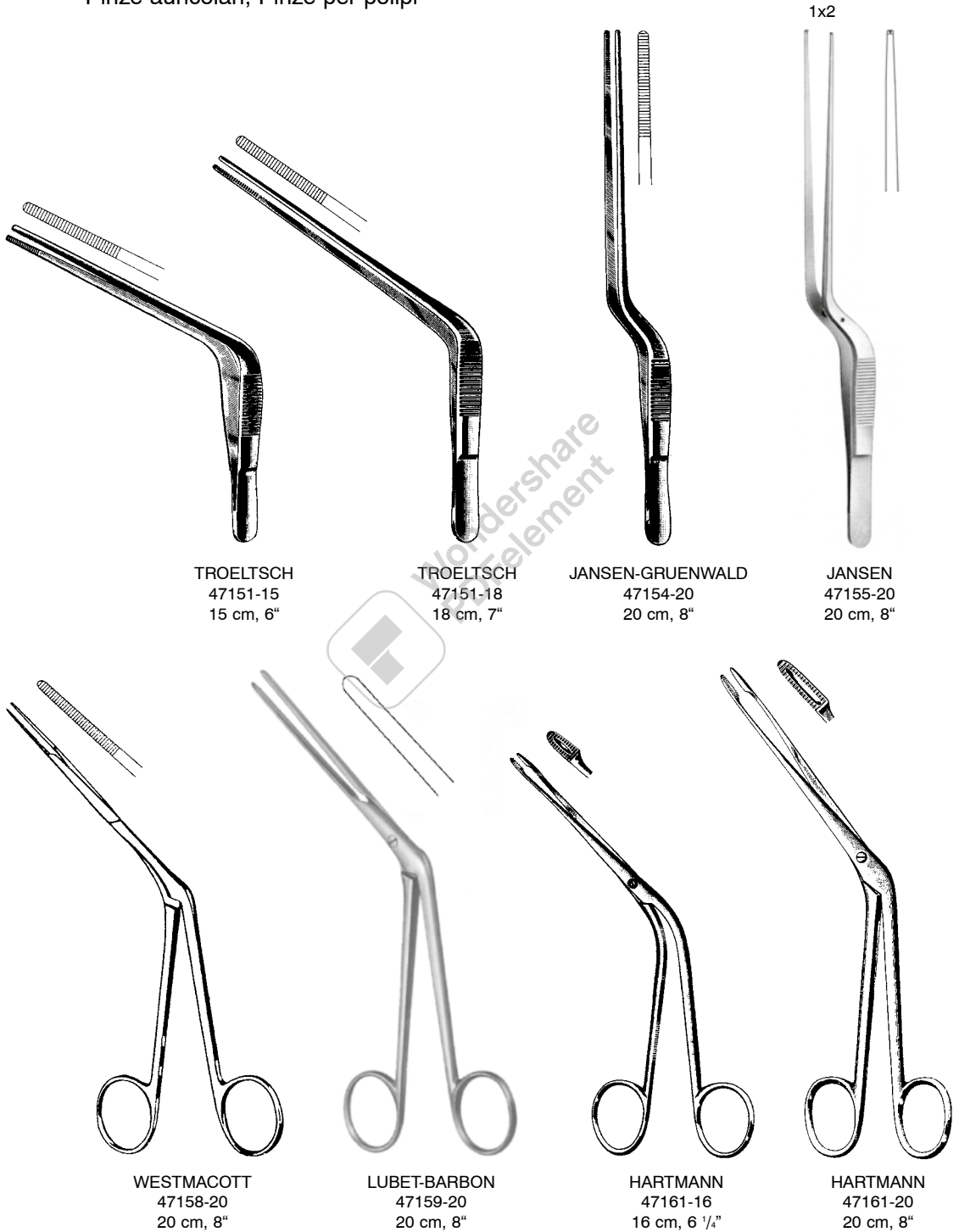
HARTMANN
16 cm, 6 1/4"



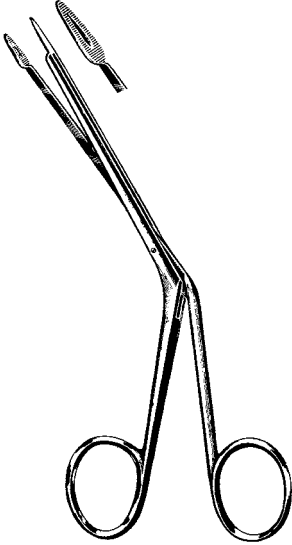
Nasenspekula, Kehlkopfspiegel
 Nasal Specula, Laryngeal Mirrors
 Espéculos nasales, espejos laríngeos
 Specoli nasali, Specchi laringei



Nasenpinzetten, Polypenzange
 Ear Dressing Forceps, Ear Polypus Forceps
 Pinzas auriculares, Pinzas para pólipos
 Pinze auricolari, Pinze per polipi



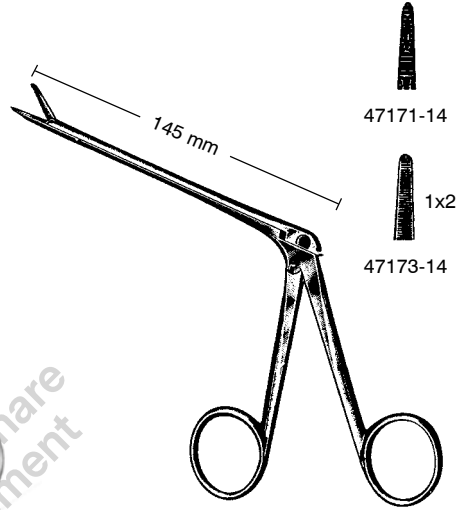
Polypenzangen, Septumzangen
 Nasal Polypus and Septum Forceps
 Pinzas para pólipos y para el tabique nasal
 Pinze per polipi, Pinze per il setto nasale



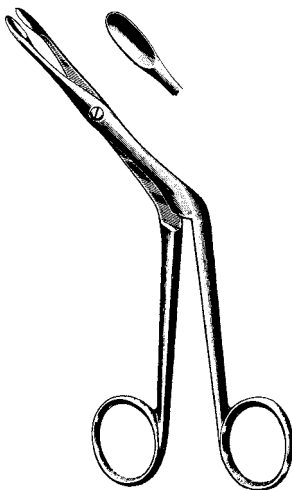
LITTAUER
 47167-18
 18 cm, 7"



HEYMANN-KNIGHT
 47169-18
 18 cm, 7"



NOYES
 47171-14 - 47173-14
 14,5 cm, 5 3/4"



HEYMANN
 47181-18
 18 cm, 7"

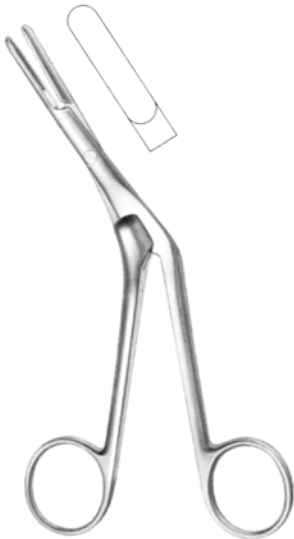


KNIGHT
 47185-18
 18 cm, 7"

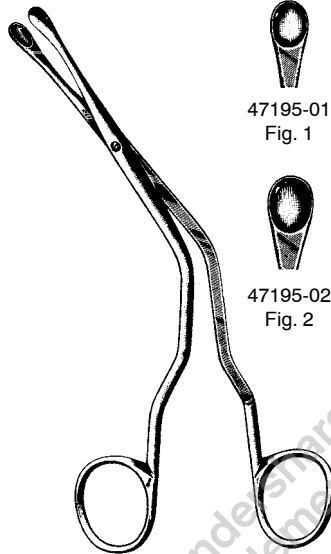


BRUENINGS
 47191-01 - 47191-04
 19 cm, 7 1/2"

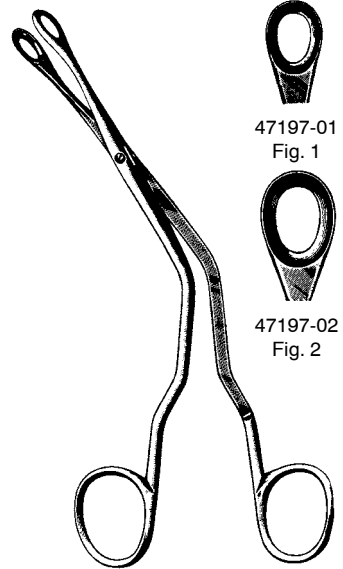
Scharfe Nasenzangen, Septumzangen
 Nasal Cutting Forceps, Septum Forceps
 Pinzas cortantes nasales y para el tabique nasal
 Pinze taglienti nasali, Pinze per il setto nasale



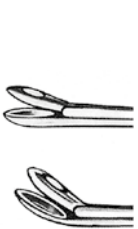
GRAIG
 47192-16
 18 cm, 7"







LUC
 47195-01 - 47195-05
 19 cm, 7 1/2"









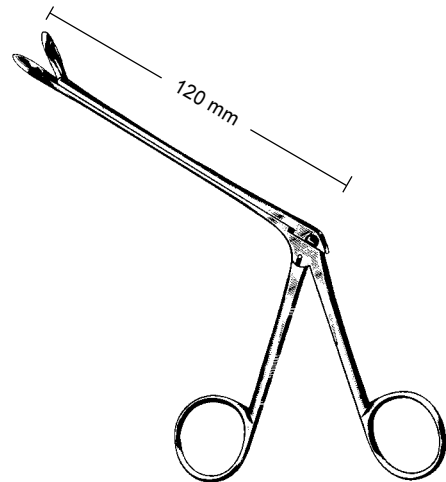
LUC
 47197-01 - 47197-02
 19 cm, 7 1/2"



	
Fig. 1 47223-01	Fig. 2 47223-02
3,0 mm	3,6 mm
	
47224-01	47224-02

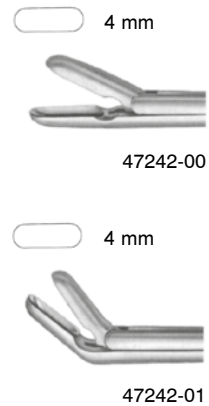
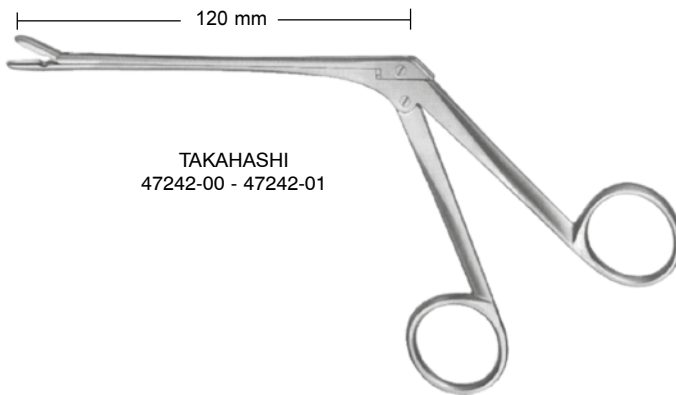
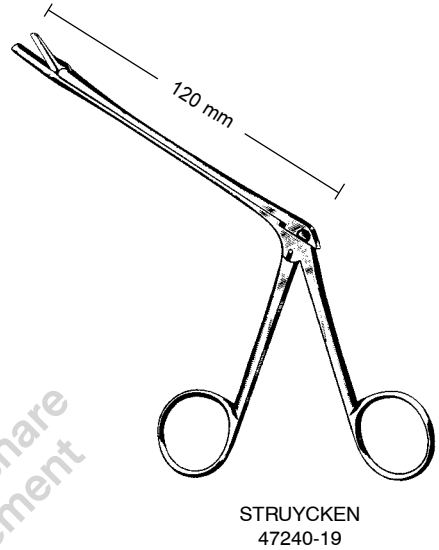
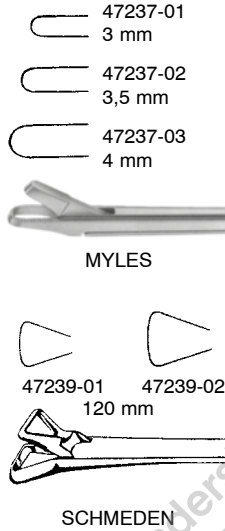
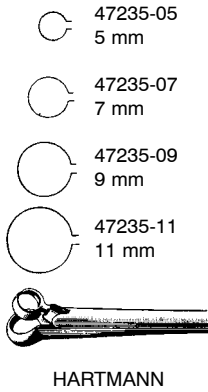


		
Fig. 3 47223-03	Fig. 4 47223-04	Fig. 5 47223-05
4,2 mm	4,8 mm	5,8 mm
		
47224-03	47224-04	47224-05



WEIL-BLAKESLEY
 47223-01 - 47224-05

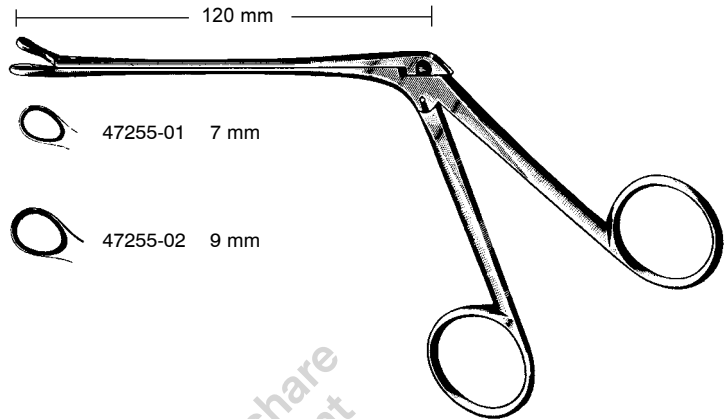
Scharfe Nasenzangen
 Nasal Cutting Forceps
 Pinzas cortantes nasales
 Pinze taglianti nasali



Scharfe Nasenzangen, Septumzange, Kieferhöhlenstanze
 Nasal Cutting Forceps, Septum Forceps, Antrum Punch Forceps
 Pinzas cortantes nasales, Pinza para magullar tabique, Pinzas cortantes para maxilares
 Pinze taglianti nasali, Pinza per ammaccare il setto, Pinze taglianti per seno mascellare



RUBIN
 47251-21
 21 cm, 8 1/4"



WATSON-WILLIAMS
 47255-01



CAPLAN
 47256-20
 20 cm, 8"



KERRISON
 3x3 mm 47303-03
 4x4 mm 47303-04
 5x5 mm 47303-05
 6x6 mm 47303-06
 17 cm, 6 3/4"

Kieferhöhlenstanze, Nasenschere
Antrum Punch Forceps, nasal scissors
Pinzas cortantes para maxilares, tijera nasal
Pinze sfenoidali, forbici nasali



47304-01 5x3,5 mm

47304-03 5x4 mm



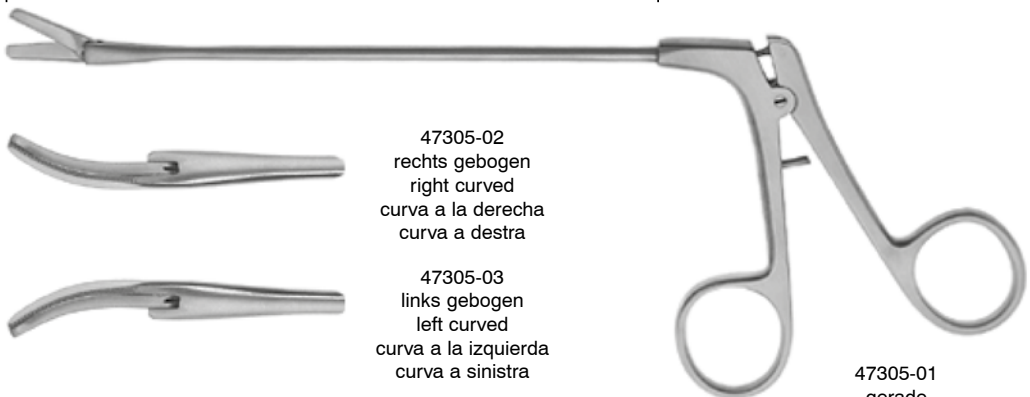
47304-02 5x3,5 mm

47304-04 5x4 mm



HAJEK-KOFLER
47304-01 - 47304-04

110 mm



47305-02
rechts gebogen
right curved
curva a la derecha
curva a destra

47305-03
links gebogen
left curved
curva a la izquierda
curva a sinistra

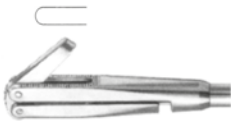
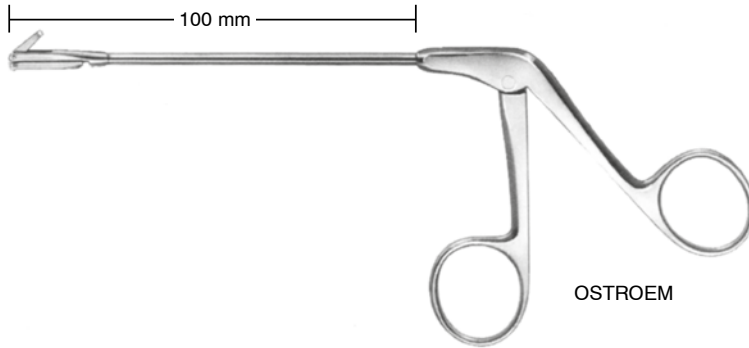
47305-01
gerade
straight
recta
retta

Knochenstanze, Septumzangen

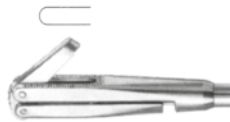
Punches, Septum Forceps

Pinzas osteótomas, Pinzas para el tabique nasal

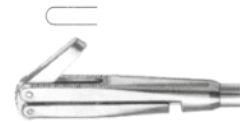
Pinze osteotomi, Pinze per il setto nasale



47315-00
2 mm
oben schneidend
up cutting
cortante por arriba
tagliente in alto



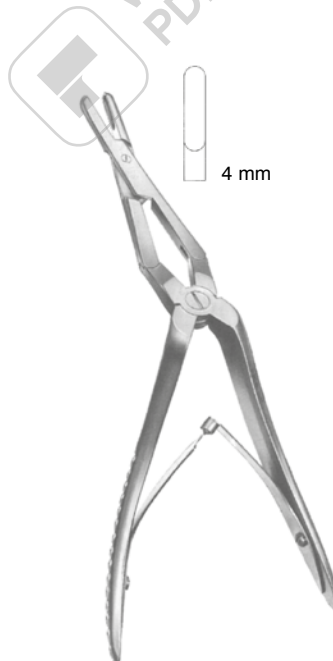
47316-00
2 mm
rechts schneidend
right cutting
cortante a la derecha
tagliente a destra



47317-00
2 mm
links schneidend
left cutting
cortante a la izquierda
tagliente a sinistra



CITELLI
47311-10 1,0 mm
47311-25 2,5 mm
47311-30 3,0 mm



MIDDLETON-JANSEN
47323-19
19 cm, 7 1/2"

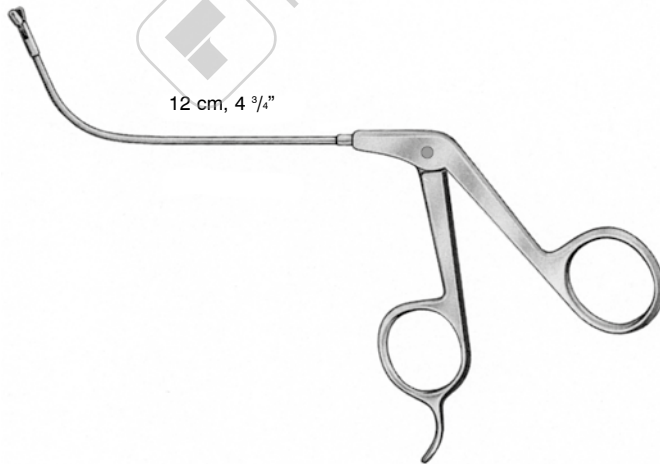


MIDDLETON-JANSEN
47325-19
19 cm, 7 1/2"

Kieferhöhlenstanze, Sinuskopie-Zangen
Antrum Punch Forceps, Sinuscopy forceps
Pinzas cortantes para maxilares, Pinzas para sinuscopia
Pinze sfenoidali per seno mascellare, Pinze per sinuscopia



HAJEK-KOFLER
47316-16
3,5 mm



Maul
jaw
boca
morso

horizontal öffnend
horizontal cutting
abierta horizontal
apertura orizzontale

vertikal öffnend
vertical cutting
abierta vertical
apertura verticale

- 65° ○ 3 mm rund
- 70° ○
- 90° ○ } oval
- 110° ○

- 47317-65
- 47317-70
- 47317-90
- 47317-11

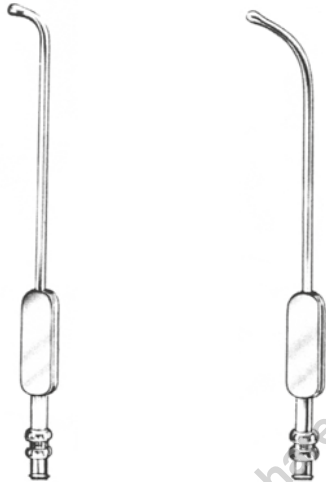
- 47318-65
- 47318-70
- 47318-90
- 47318-11

Zirkular Stanze
Circular Forceps
Pinza circular
Pinza circolare



Wondershare
PDFelement

Spülkanülen, Stirnhöhledilatator
cannulas, Frontal sinus bougies
cánulas, Dilatador para el seno
cannulas, Dilatatore per seno frontale



EICKEN (KILLIAN)

14,5 cm, 5 ³/₁₆"

Ø

47331-20	2,0 mm	47332-20
47331-25	2,5 mm	47332-25
47331-30	3,0 mm	47332-30
47331-40	4,0 mm	47332-40



Ø mm RITTER-HALLE

2,5	47342-25
3,0	47342-30
4,0	47342-40

Kiefer- und Stirnhöhlen-Spülkanülen, Saugraspatorium
Antrum and Frontal Sinus Wash Cannulas, Suction Raspatory
Cànulas lavadoras para seno maxilar y seno frontal, Legra de succión
Cannule per seno mascellare e seno frontale, Raspatorio con aspiratore



KILLIAN
Ø 1,5 mm
47345-15



GUILEN
19 cm, 7 1/2"
47347-20

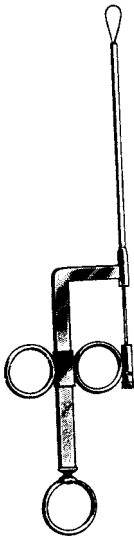
Polypenschnürer
 Nasal Polypus Snares
 Polipótomos
 Serrandi



KRAUSE-VOSS
 47350-26
 26 cm, 10 1/4"



KRAUSE
 47351-26
 26 cm, 10 1/4"



WILDE
 47352-24
 24 cm, 9 1/2"



Bündel mit 12 Stück
 Bundle with 12 pieces
 12 piezas atados
 confezione di 12 pezzi

47355-03 0,3 mm

Nasenmesser
Nasal Knives
Bisturies nasales
Coltelli nasali



JOSEPH
47370-16 - 47373-16
16 cm, 6 1/4"



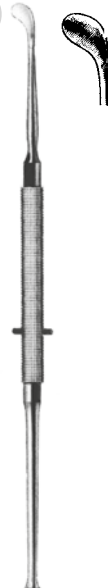
47370-16 47371-16
stumpf, blunt,
romos, smussi



47372-16 47373-16
spitz, pointed,
agudos, acuti



FREER
47374-16
16,5 cm, 6 1/2"

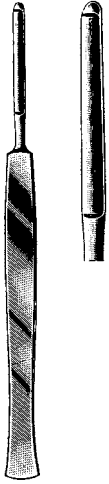


FREER
47375-19
19 cm, 7 1/2"

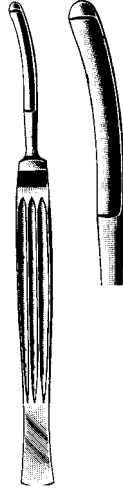


JOSEPH
47375-16
16,5 cm, 6 1/2"

Nasenplastik- und Operationsmesser, Sichelmesser, Küretten
 Rhinoplastic and Nasal Knives, Septum Sickle Knives, Curettes
 Bisturios para plastica y operaciones de la nariz, Bisturios para el tabique nasal, Curetas
 Bisturi per la plastica ed operazioni nasali, coltelli per setto, Curette



JOSEPH
47376-16
16 cm, 6 1/4"



CONVERSE
47379-16
16 cm, 6 1/4"



COTTLE
47380-15
15 cm, 6"



COTTLE
47382-15
15 cm, 6"



JOSEPH
47384-15
15 cm, 6"



JOSEPH
47385-15
15 cm, 6"



HADEO
19 cm, 7 1/2"



47386-01
spitz
pointed
agudo
acuto



47386-02
stumpf
blunt
romo
smusso



ANTRUM
19 cm, 7 1/2"



47387-01
vorwärts schneidend
forward cutting
corte hacia adelante
taglio in avanti



47387-02
rückwärts schneidend
backward cutting
corte hacia atras
taglio retrograde

Schwingmesser
Septum Swivel Knives
Bisturies para el tabique nasal
Coltelli per setto



BALLENGER
47390-03 - 47392-05
20 cm, 8"



47390-03
3 mm



47390-04
4 mm



47390-05
5 mm



47392-03
3 mm



47392-04
4 mm



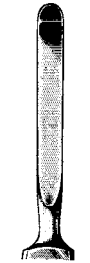
47392-05
5 mm



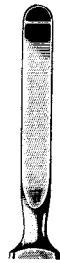
Septum Elevatoren
Septum Elevators
Elevadores para el tabique
Elevatori per setto



McKENTY
47410-04 - 47410-05
15 cm, 6"



47410-04
4 mm



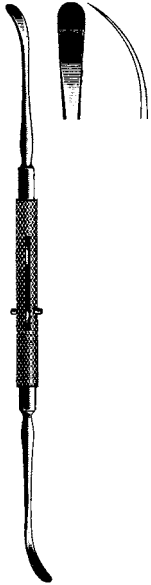
47410-05
5 mm



HALLE
47410-16
16.5 cm, 6 1/2"



JOSEPH
47411-16
16 cm, 6 1/4"



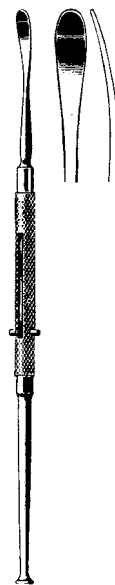
ROGER
47413-19
19 cm, 7 1/2"



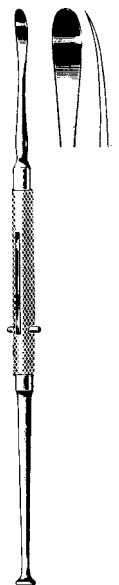
MASING
47414-21
22 cm, 8 3/4"



FREER
47415-18
18 cm, 7"



FREER
47417-19
19 cm, 7 1/2"



FREER
47419-19
19 cm, 7 1/2"

Septum Elevatoren
Septum Elevators
Elevadores para el tabique
Elevatori per setto



KILLIAN
47420-01
18,5 cm, 7 1/4"



PIERCE
47420-02
21 cm, 8 1/4"



SINUS
47420-03
18 cm, 7"



PENNINGTON
47420-04
21 cm, 8 1/4"

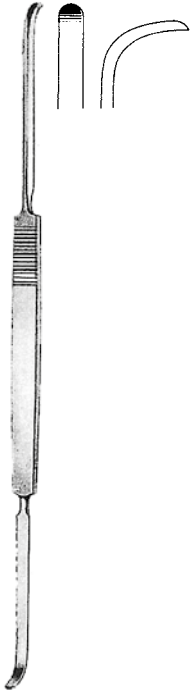


McKENTY
47420-20
22 cm, 8 3/4"



HOWARTH
47421-21
21,5 cm, 8 1/2"

Septum Elevatoren
Septum Elevators
Elevadores para el tabique
Elevatori per setto



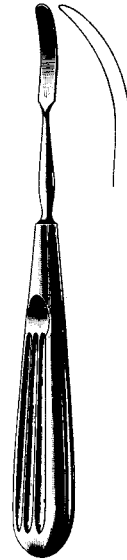
COTTLE
47421-23
23 cm, 9"



COTTLE JOSEPH
47422-22
22 cm, 8 3/4"



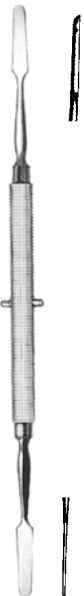
COTTLE
47423-22
22 cm, 8 3/4"



COTTLE
47424-16
16 cm, 6 1/4"



COTTLE
47425-19
19 cm, 7 1/2"



KILLIAN
47426-22
22 cm, 8 3/4"



HAJEK-BALLENGER
47428-21
22 cm, 8 3/4"



BALLENGER
47430-22
22 cm, 8 3/4"

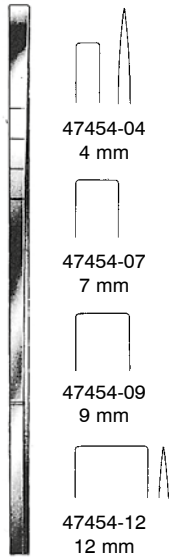


FREER
47450-04
15 cm, 6"



FREER
47451-04
15 cm, 6"

Osteotome, Knorpelquetscher
 Osteotomes, Cartilage crusher
 Osteótomos, Macha cadera
 Osteotomi, Tritacartilagine



47454-04
4 mm

47454-07
7 mm

47454-09
9 mm

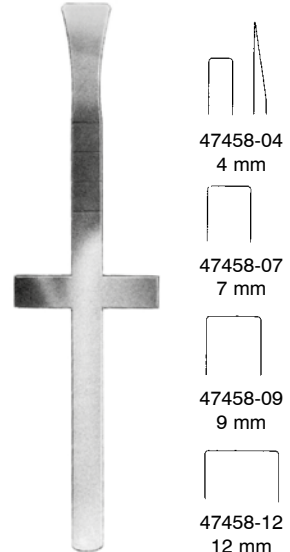
47454-12
12 mm

COTTLE
47454-04 - 47454-12
18 cm, 7"



6 mm

COTTLE
47455-06
18 cm, 7"



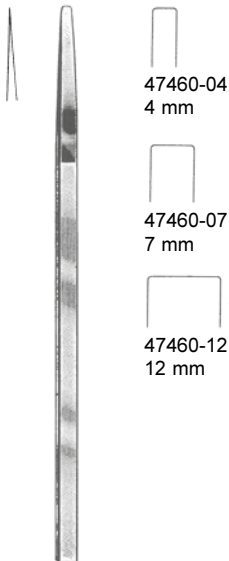
47458-04
4 mm

47458-07
7 mm

47458-09
9 mm

47458-12
12 mm

COTTLE
47458-04 - 47458-12
18 cm, 7"



47460-04
4 mm

47460-07
7 mm

47460-12
12 mm

COTTLE
18 cm, 7"

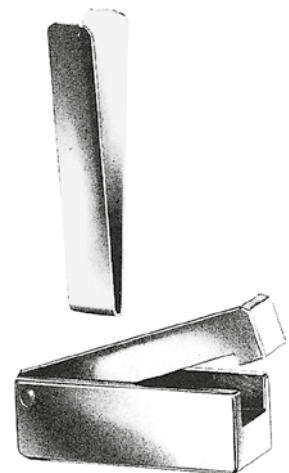


47463-10
10 mm

47463-12
12 mm

47463-14
14 mm

RUBIN
18,5 cm, 7 1/4"



COTTLE
Knorpelquetscher
47461-00

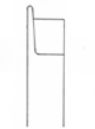
Osteotome, Septum Meißel
Osteotomes, Rhinoplastic Chisels
Osteótomos, Cinceles para la plàstica nasal
Osteotomi, Scalpelli per plastica nasale



47470-04
4 mm



47470-05
5 mm



47470-06
6 mm



47470-07
7 mm

FOMON
47470-04 - 47470-07
17 cm, 6 3/4"



47471-02
2 mm



47471-03
3 mm



47471-04
4 mm



47471-05
5 mm



47471-06
6 mm



47471-07
7 mm



47471-08
8 mm

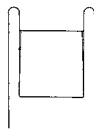


47471-10
10 mm



47471-12
12 mm

SHEEHAN
47471-07 - 47471-12
16 cm, 6 3/4"



47472-10
10 mm



47472-12
12 mm



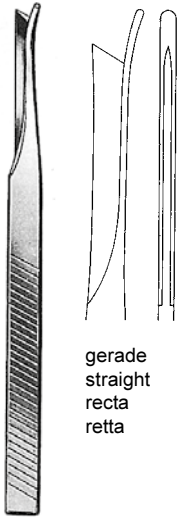
47472-14
14 mm



47472-16
16 mm

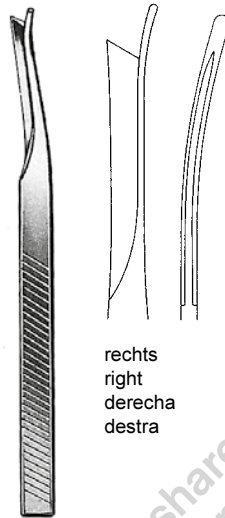
CINELLI
47472-10 - 47472-16
16 cm, 6 1/4"

Septum Meißel, Osteotom
 Rhinoplastic Chisels, Osteotom
 Cinceles para la plástica nasal, Osteotom
 Scalpelli per plastica nasale, Osteotom



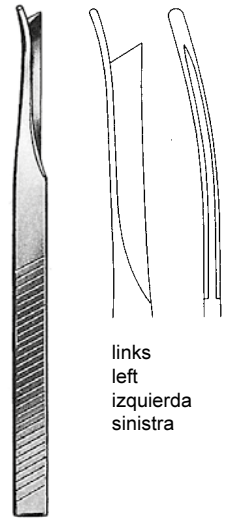
gerade
 straight
 recta
 retta

SILVER
 47473-01
 18 cm, 7"



rechts
 right
 derecha
 destra

SILVER
 47473-02
 18 cm, 7"



links
 left
 izquierda
 sinistra

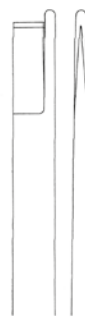
SILVER
 47473-03
 18 cm, 7"



47474-01
 rechts
 right
 derecha
 destra



47474-02
 links
 left
 izquierda
 sinistra



47474-03
 gerade
 straight
 recta
 retta

NEIVERT-ANDERSON
 47474-01 - 47474-03
 20,5 cm, 8" 7 mm

Septum-Hohlmeißel, Osteotom
Septum Gouges, Osteotom
Gubias para tabique nasal, Osteótom
Sgorbie per il setto nasale, Osteotom



KILLIAN
47481-05
16 cm, 6 1/4"



KILLIAN-CLAUS
47482-05
17 cm, 6 3/4"



mm	HAJEK
4	47484-04
6	47484-06
8	47484-08
	16 cm, 6 1/4"



WEST
47486-16
16 cm, 6 1/4"



WEST
47487-16
16 cm, 6 1/4"

6 mm



FREER
47489-16
16 cm, 6 1/4"



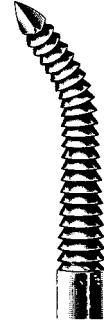
Knochenfeile, Nasenraspeln
 Bone File, Nasal Rasps
 Limas para hueso, Escofinas nasales
 Lime per ossa, Raspa nasale



JOSEPH
 47502-16
 16 cm, 6 1/4"



MALTZ
 47504-18
 18 cm, 7"

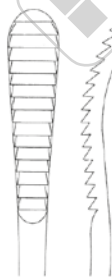
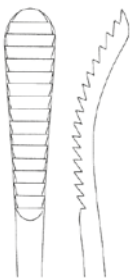


47507-17

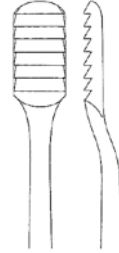
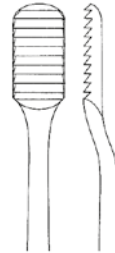


47507-19

WIENER
 47507-17 - 47507-19
 18 cm, 7"

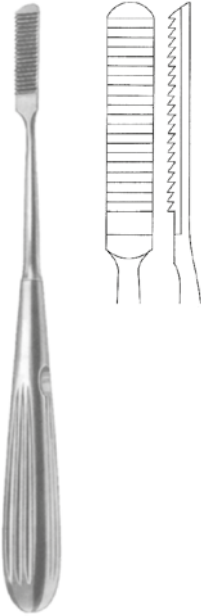


AUFRICHT
 47511-21 21 cm, 8 1/4" 47513-21

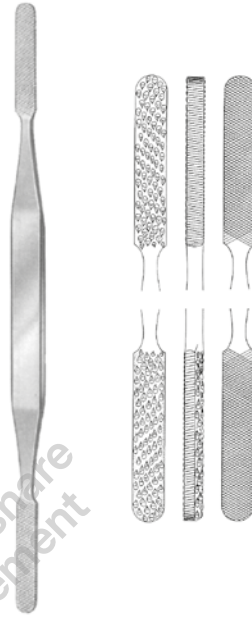


JOSEPH (LEWIS)
 47514-16 18 cm, 7" 47516-16

Nasenraspeln
Nasal Rasps
Escofinas nasales
Raspa nasale



MALTZ (COTTLE)
47518-21
21 cm, 8 1/4"



FOMON
47520-21
21 cm, 8 1/4"



MILLER
18 cm, 7"



47521-01

5 mm



47521-02

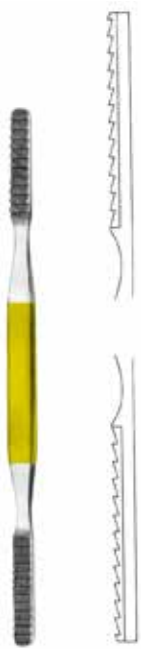
4,3 mm



47521-03

5 mm

Nasenraspeln
Nasal Rasps
Escofinas nasales
Raspa nasale



FOMON

47522-01 - 47522-09 TC
20 cm, 8"

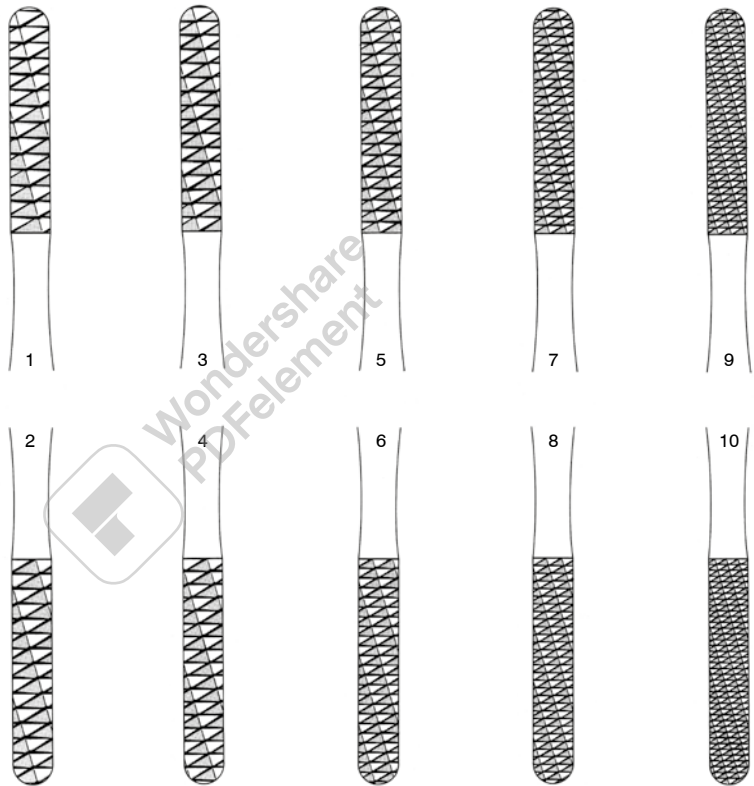


Fig. 1/2

47522-01 TC

Fig. 3/4

47522-04 TC

Fig. 5/6

47522-05 TC

Fig. 7/8

47522-07 TC

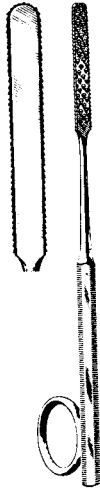
Fig. 9/10

47522-09 TC

Nasenraspeln, Nasensägen
 Nasal Rasps, Nasal Saws
 Escofinas nasales, Sierras nasales
 Raspa nasale, Seghe nasale



PEET
 47523-01 —
 47523-02 —
 19 cm, 7 1/2"



GALLAHER
 47526-16 - 47529-16
 16 cm, 6 1/4"



Fig. 1
 47526-16

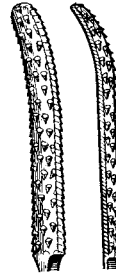


Fig. 2
 47527-16

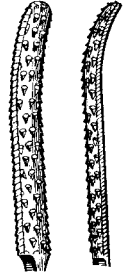


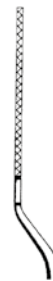
Fig. 3
 47529-16



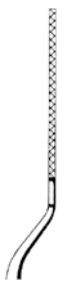
JOSEPH
 47535-01 47535-02
 17 cm, 6 3/4"



47533-19
 gerade
 straight
 recta
 retta



47532-19
 links
 left
 izquierda
 sinistra



47534-19
 rechts
 right
 derecha
 destra

JOSEPH
 19 cm, 7 1/2"

Nasenhaken
Nasal retractor
Retradores nasales
Retrattori nasali



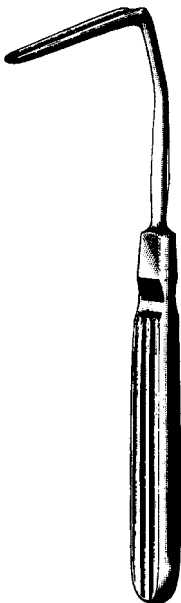
COTTLE
47540-16
16 cm, 6 1/4"



MASING
47541-14
14 cm, 5 1/2"



AUFRICHT
47542-12
12 cm, 4 3/4"



AUFRICHT
47551-16
16 cm, 6 1/4"



AUFRICHT
47551-16L
16 cm, 6 1/4"



MASING-NEIVERT
47552-16
16 cm, 6 1/4"

Nasenhaken, Hauthäkchen
 Nasal retractor
 Retractores nasales, Ganchos para la piel
 Retrattori nasali, uncini nasali

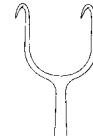
10 x 12 mm



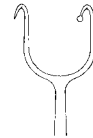
COTTLE
 47553-15
 15 cm, 6"



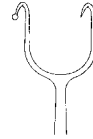
COTTLE
 14,5 cm, 5 3/4"



47554-01



47554-02

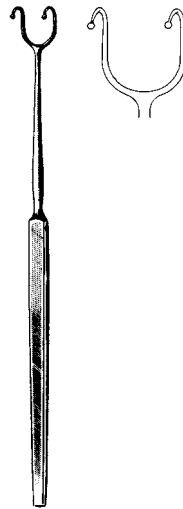


47554-03

3 x 11 mm



KILNER
 47555-08
 8 cm, 3 1/8"



FOMON
 47556-16
 16 cm, 6 1/4"



FOMON
 47557-17
 17 cm, 6 3/4"



Hauthäkchen, Columella Pinzette
 Retractor, Columnella forceps
 Ganchos para la piel, Pinza para columella
 Uncini, Pinzetta columella



FREER
 47558-15
 15 cm, 6"



COTTLE-NEIVERT
 47559-20
 20 cm, 8"



GILLIES
 18 cm, 7"



Fig. 1
 47560-18



Fig. 2
 47562-18



LANGE
 47563-22
 23 cm, 9"



COTTLE
 47564-16
 16 cm, 6 1/4"

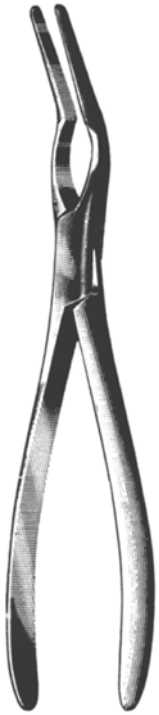


COTTLE
 47565-10
 10 cm, 4"



CONVERSE
 47566-12
 12 cm, 4 3/4"

Septumrichtzangen, Kùretten
 Septum Straightening Forceps, Curettes
 Pinza para enderezar el tabique nasal, curetas
 Pinza per la plastica nasale, Curette



ASCH
 47571-23
 23 cm, 9"



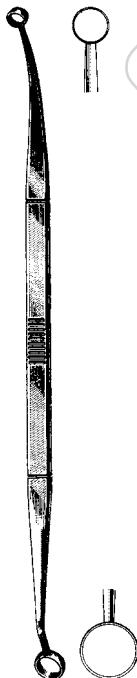
WALSHAM
 47572-23 - 47575-23
 23 cm, 9"



47572-23
 gerade
 straight
 recta
 retta

47573-23
 links
 left
 izquierda
 a sinistra

47575-23
 rechts
 right
 derecha
 a destra



FAULKNER
 47601-21
 21 cm, 8 1/4"



COAKLEY
 47607-01 - 47607-06
 17 cm, 6 3/4"



47607-01
 Fig. 1



47607-02
 Fig. 2



47607-03
 Fig. 3



47607-04
 Fig. 4

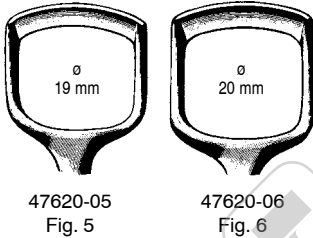
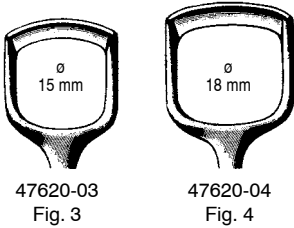
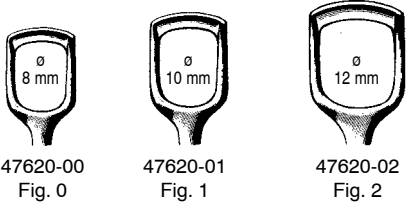


47607-05
 Fig. 5

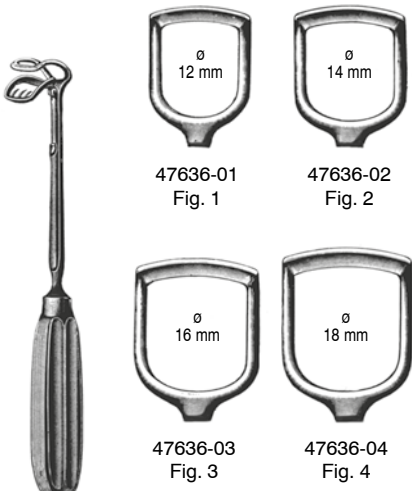


47607-06
 Fig. 6

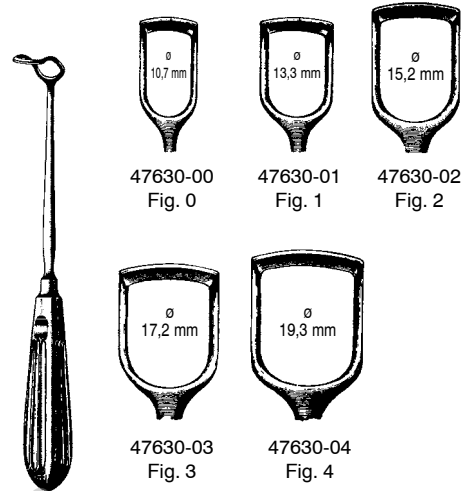
Ringmesser
Adenoid Curettes
Cuchillos para vegetaciones adenoides
Coltelli per vegetazioni adenoide



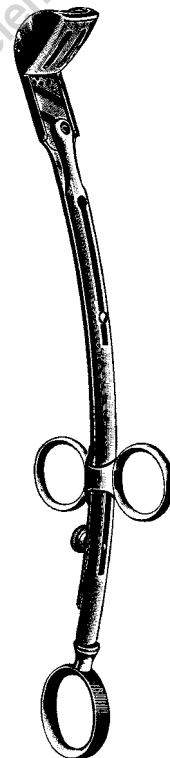
BECKMANN
47620-01 - 47620-06
22 cm, 8 3/4"



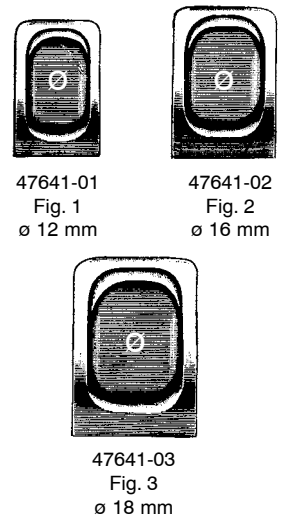
St. CLAIR-THOMSON
47636-01 - 47636-04
21 cm, 8 1/4"



BARNHILL
47630-01 - 47630-04
21 cm, 8 1/4"



LAFORCE
47641-01 - 47641-03
25 cm, 10"



Ersatzklingen allein, gelocht
Spare blades, perforated
Hojas de repuesto, perforadas
Lame di ricambio, forate

Fig. 1 47642-01
Fig. 2 47642-02
Fig. 3 47642-03

Zungenspatel, Wangen- und Lippenhalter
Tongue Depressors, Cheek and Lip Retractors
Baja-lenguas, Separadores para labios y mejillas
Abbassalingua, Divaricatori per guance e labbra

Holz
wood
madera
legno



49102-16
16 cm, 6 1/4"
Pack. à 100

21,7 mm



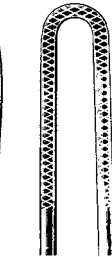
MAYO
49103-17
17 cm, 6 3/4"

21,4 mm



KROENIG
49104-15
15 cm, 6"

23 mm



FRENZEL
49105-16
16,5 cm, 6 1/2"
13 mm

16 mm



49106-01
14,5 cm, 5 3/4"

15 mm



49106-02
14,5 cm, 5 3/4"

15 mm



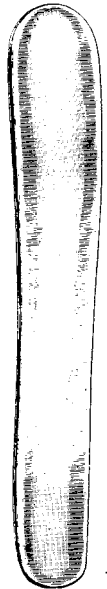
BRUENINGS
49107-19
19 cm, 7 1/2"

20 mm



CAWOOD-MINNESOTA
49108-15
15 cm, 6"

23 mm

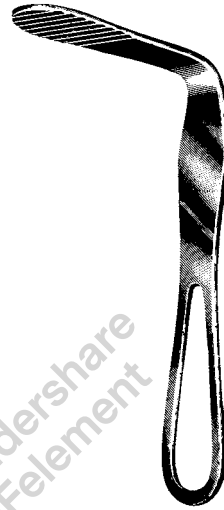


BUCHWALD
49109-19
19 cm, 7 1/2"

Zungendrucker
Tongue Depressors
Baja-lenguas
Abassalingua



MORITZ-SCHMIDT
49110-19
19 cm, 7 1/2"



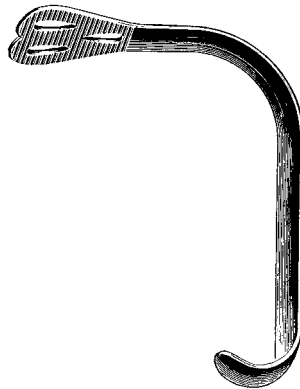
HARTMANN
49111-15
15 cm, 6"



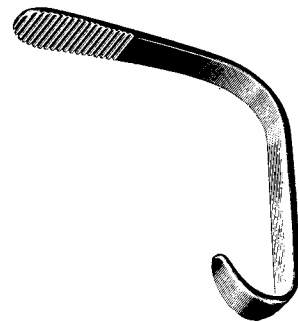
49115-01
Fig. 1
14 cm, 5 1/2"



49115-02
Fig. 2
15 cm, 6"

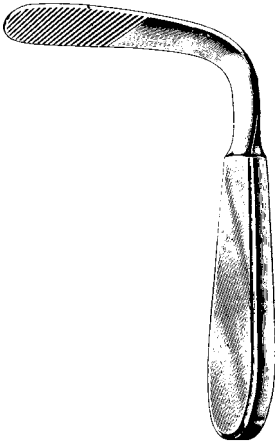


WIEDER
49115-01 - 49115-02

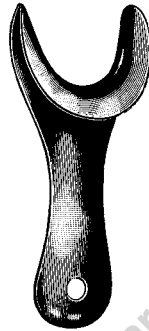


ANDREW
49117-11
11 cm, 4 3/8"

Zungendrucker, Wangen- und Lippenhalter, Zungenzangen
Tongue Depressor, Cheek and Lip Retractor, Tongue Holding Forceps
Baja-lenguas, Separadores para labios y mejillas, Pinza tira-lenguas
Abassalingua, Divaricatori per guance e labbra, Pinza tiralingua



TOBOLD
49119-14
14,5 cm, 5 ³/₄"



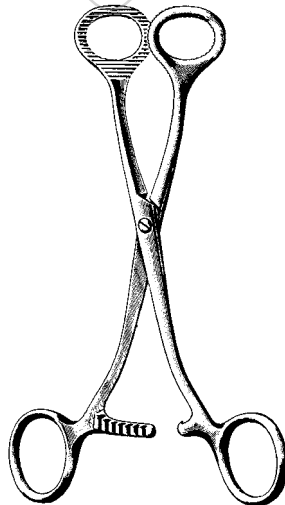
49230-11
11 cm, 4 ³/₄"



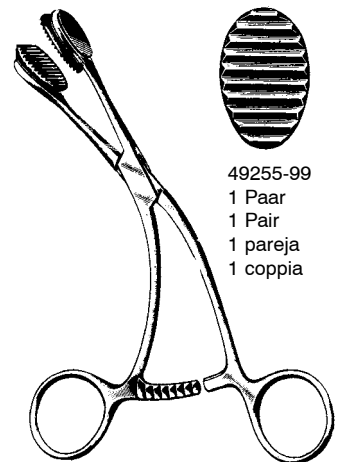
26 mm
37 mm
STERNBERG
49231-12 12 cm, 4 ³/₄"
49231-14 14 cm, 5 ¹/₂"
49231-16 16 cm, 6 ¹/₄"



49235-19
19 cm, 7 ¹/₂"



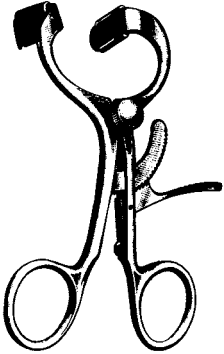
COLLIN
49250-16 16 cm, 6 ¹/₄"
49250-18 18 cm, 7"



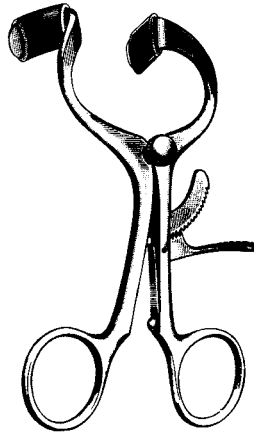
49255-99
1 Paar
1 Pair
1 pareja
1 coppia

YOUNG
49255-16
16 cm, 6 ¹/₄"

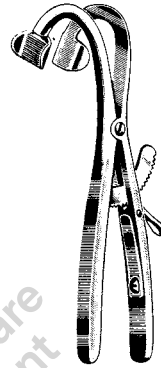
Mundsperrer
Mouth Gags
Abre-Bocas
Apribocca



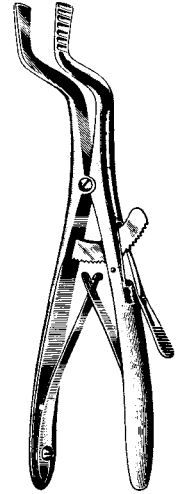
DOYEN-JANSEN (MOLT)
49265-12
12 cm, 4 ³/₄"



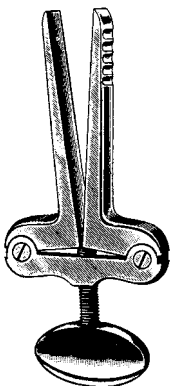
DOYEN-JANSEN (MOLT)
49265-14
14 cm, 5 ¹/₂"



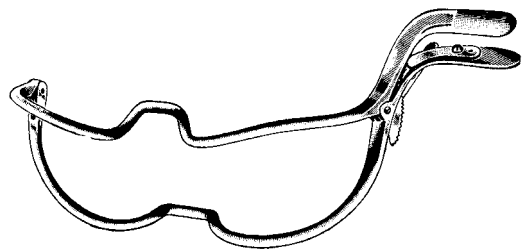
DENHART
49267-12
12 cm, 4 ³/₄"



ROSER-KOENIG
49270-16 16 cm, 6 ¹/₄"
49270-19 19 cm, 7 ¹/₂"

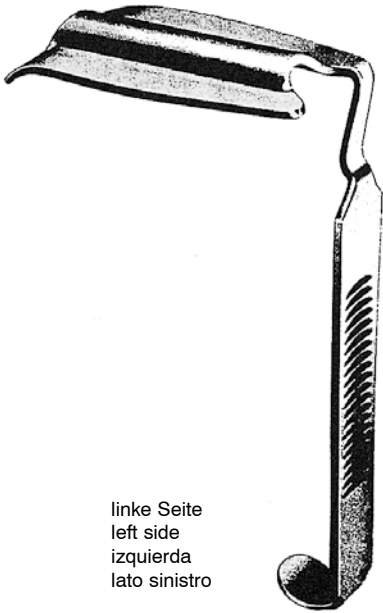


HEISTER
49272-13
13 cm, 5 ¹/₈"



JENNINGS
49274-09 9 cm, 3 ¹/₂"
49274-11 11 cm, 4 ³/₈"
49274-13 13 cm, 5 ¹/₈"
49274-15 15 cm, 6"

Zungenspatel, Mundsperrer
Tongue depressor, Mouth Gags
Baja-lengua, Abrebocas
Abbassalingua, Apribocca



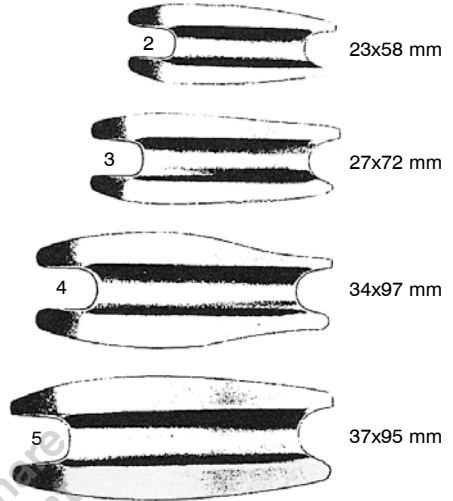
linke Seite
left side
izquierda
lato sinistro



rechte Seite
right side
derecha
lato destro

RING

- | | | |
|----------|--------|----------|
| 49287-02 | Fig. 2 | 49288-02 |
| 49287-03 | Fig. 3 | 49288-03 |
| 49287-04 | Fig. 4 | 49288-04 |
| 49287-05 | Fig. 5 | 49288-05 |

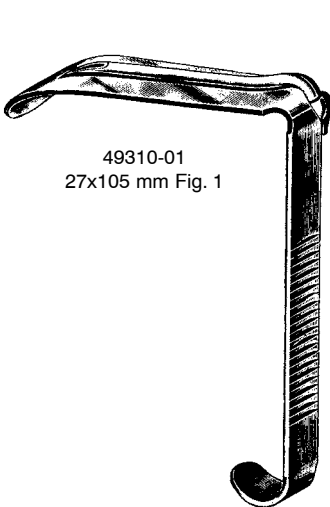


23x58 mm

27x72 mm

34x97 mm

37x95 mm



49310-01
27x105 mm Fig. 1

DAVIS-BOYLE
49310-00
compl.



49310-02
25x90 mm Fig. 2



49310-03
25x75 mm Fig. 3

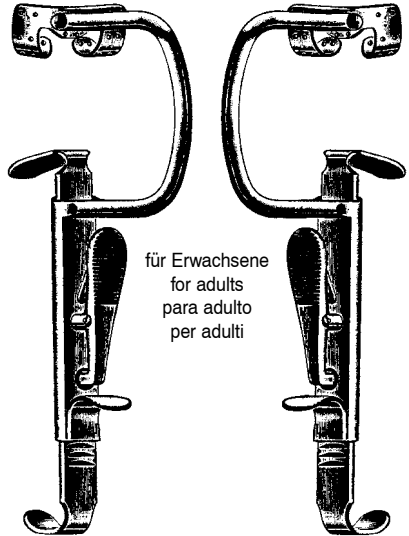


49310-04
22x60 mm Fig. 4



49310-05
20x25 mm Fig. 5

49310-08 Silikoneinlagen/Silicone pads
inserto de silicona/inserto in silicone

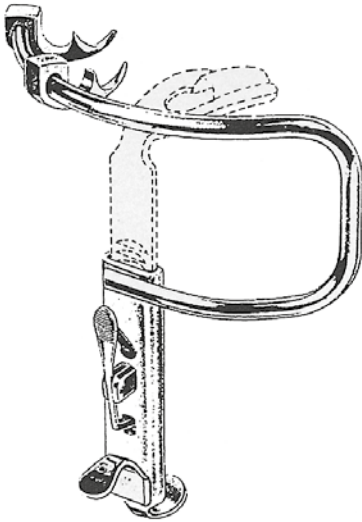


für Erwachsene
for adults
para adulto
per adulti

49310-10
Sperrer allein, links
Gag only, left
Abre-boca suelta, izquierda
Apribocca solo, sinistra

49310-12
Sperrer allein, rechts
Gag only, right
Abre-boca suelta, derecha
Apribocca solo, destra

Mundsperrer
Mouth Gags
Abre-Bocas
Apribocca



49315-10
Sperrer allein
Gag only
Abre-boca solo
Apribocca solo



49315-01
37 x 80 mm
Fig. 1



49315-02
32 x 75 mm
Fig. 2



49315-03
28 x 65 mm
Fig. 3

KILNER-DOUGHTY

49315-00
komplett
complete
complete

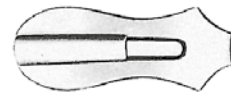
49317-00 DINGMANN, complete

mit 3 auswechselbaren Zungendrucker,
2 seitliche Wangenhaken und 2 Zahnhaken

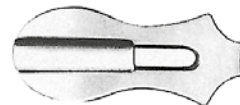
with 3 interchangeable tongue depressors,
2 rotating cheek holders
2 movable tooth hooks and thread guide

con 3 baja lenguas intercambiables,
2 valvas giratorias p. los labios,
2 ganchos graduables

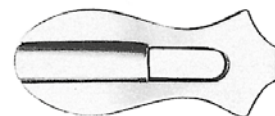
con 3 depressori intercambiabili,
2 valve laterali rotative
2 uncini a denti mobile



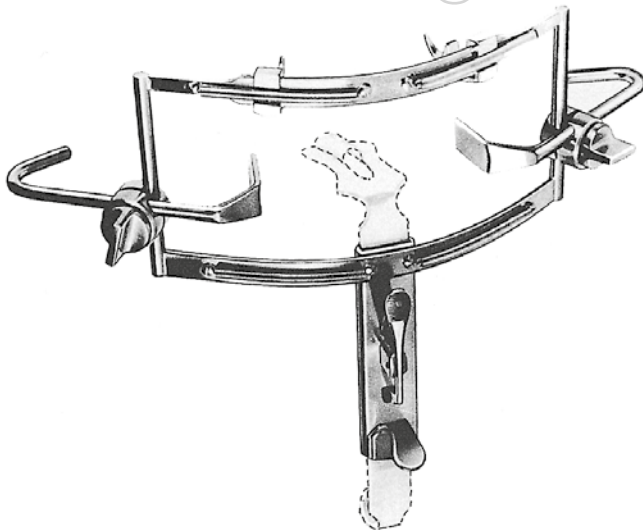
1 24x62 mm
49317-01



2 28x65 mm
49317-02



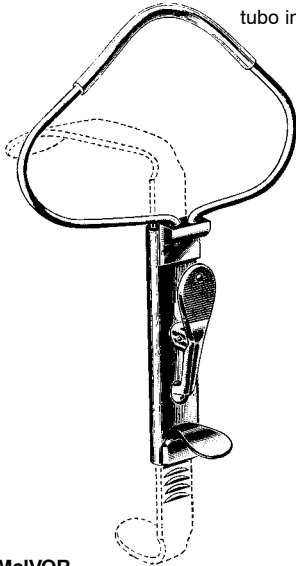
3 31x75 mm
49317-03



DINGMANN
49317-10
Sperrer allein, Gag only
Abre-boca solo, Apribocca solo

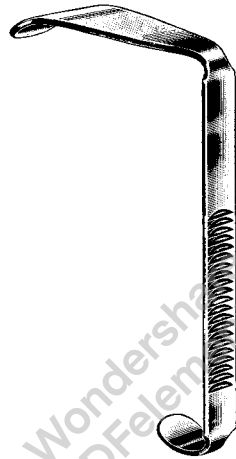
Mundsperrer
Mouth Gag
Abre-bocas
Apribocca

49320-20
Silikon-Schlauch
Silicon Tubing
tubo de silicona
tubo in silicone

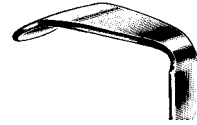


McIVOR
49320-00
compl.

49320-10



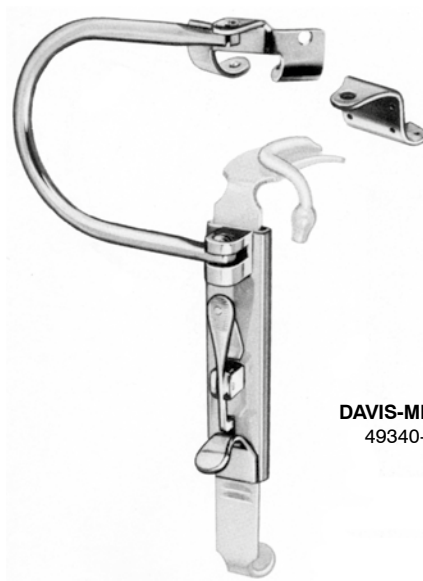
49320-01
27x95 mm Fig. 1



49320-02
22x85 mm Fig. 2

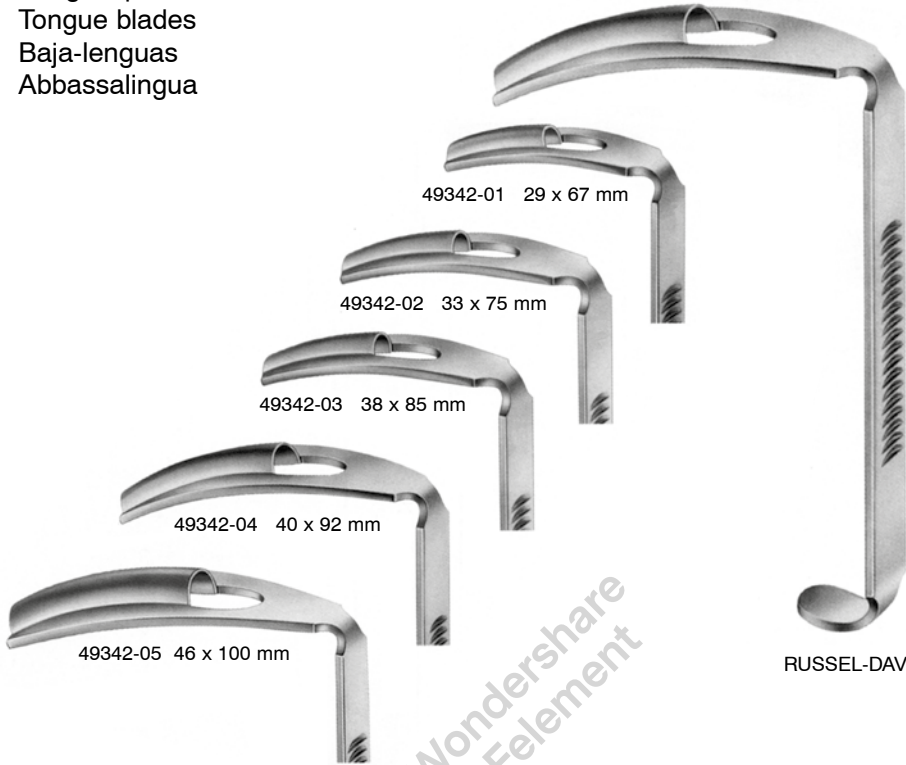


49320-03
22x70 mm Fig. 3



DAVIS-MEYER
49340-00

Zungenspatel
Tongue blades
Baja-lenguas
Abbassalingua



49342-01 29 x 67 mm

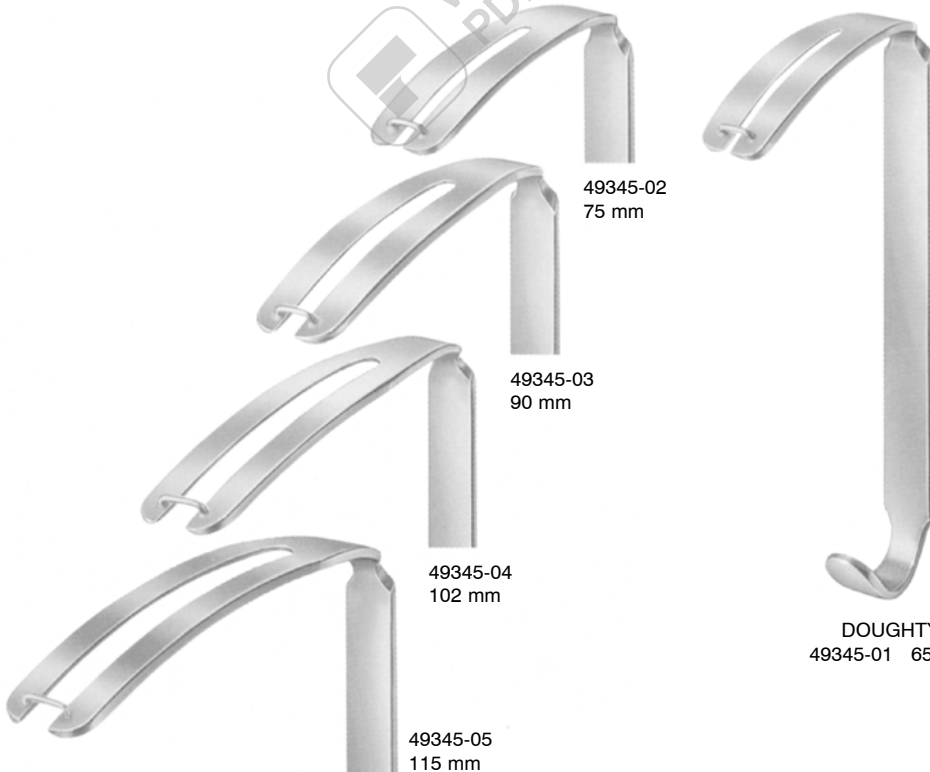
49342-02 33 x 75 mm

49342-03 38 x 85 mm

49342-04 40 x 92 mm

49342-05 46 x 100 mm

RUSSEL-DAVIS



49345-02
75 mm

49345-03
90 mm

49345-04
102 mm

49345-05
115 mm

DOUGHTY
49345-01 65 mm

Mundkeil, Bruststütze, Repositionszange
 Oral wedges, Chest support, Disimpaction forceps
 Abreboca, Soporte de pecho, Pinzas para reposiciones
 Apribocca, Supporto per petto, Pinze per riposizione

Holz
 wood
 madera
 legno



MAUNDER
 49360-10



NEGUS
 49400-01



links
 left side
 izquierda
 lato sinistro

ROWE

49501-22 22,5 cm, 8,9"
 49501-23 23,5 cm, 9 1/4"
 49501-24 24,0 cm, 9 1/2"

Baby, baby, bebé, lattante
 Kind, child, niño, bambino
 Erwachs., adult, adulto



rechts
 right side
 derecha
 lato destro

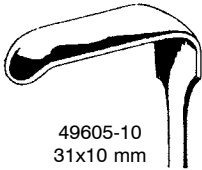
ROWE

49503-22 22,5 cm, 8,9"
 49503-23 23,5 cm, 9 1/4"
 49503-24 24,0 cm, 9 1/2"

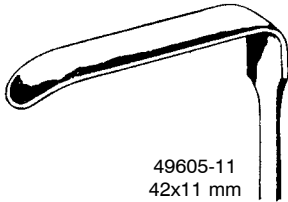
Wundhaken für Mund-Kiefer-Gesicht
 Retractors for Mouth-, Jaw- and Face Surgery
 Separadores para cirugía plástica
 Divaricatori per chirurgia plastica



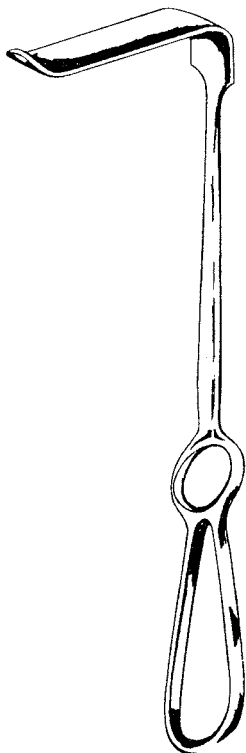
49605-07
25x7 mm



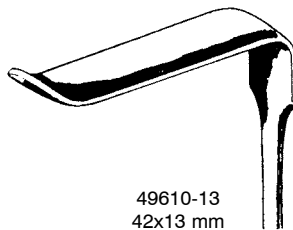
49605-10
31x10 mm



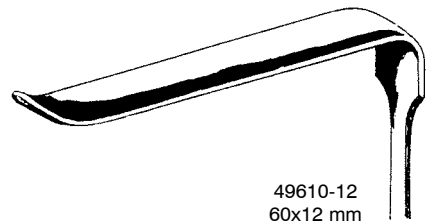
49605-11
42x11 mm



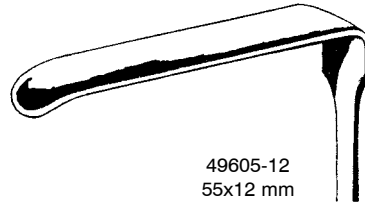
OBWEGESER
49610-12 - 49610-16
22 cm, 8 3/4"



49610-13
42x13 mm



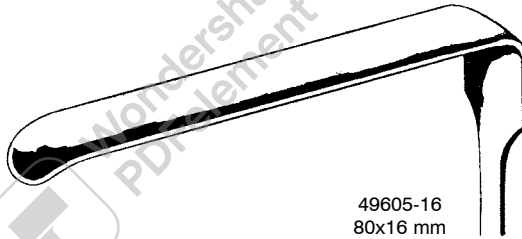
49610-12
60x12 mm



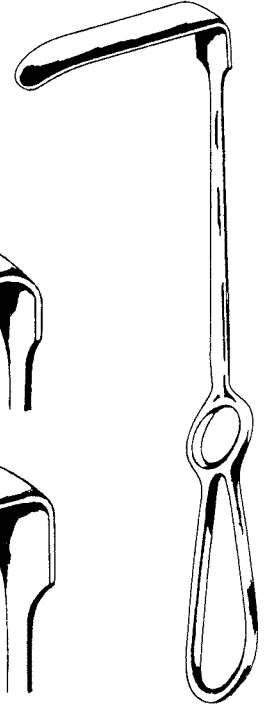
49605-12
55x12 mm



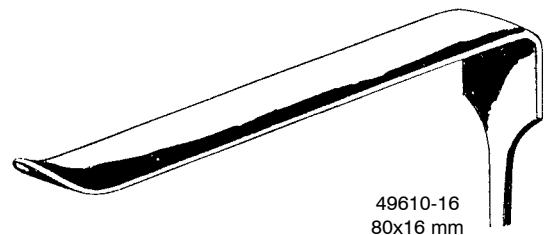
49605-14
70x14 mm



49605-16
80x16 mm

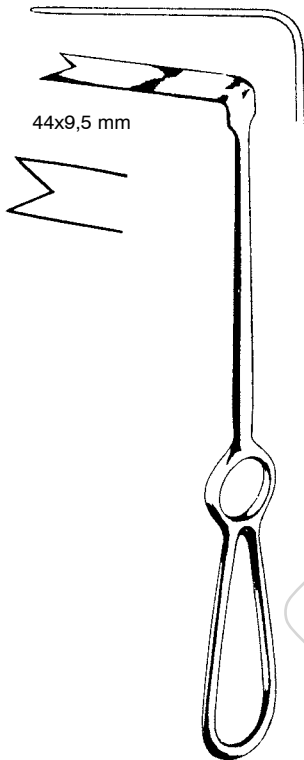


OBWEGESER
49605-07 - 49605-16
22 cm, 8 3/4"

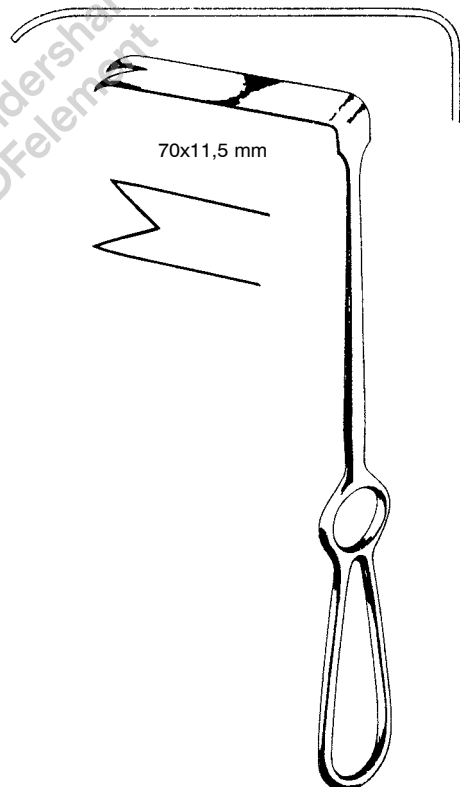


49610-16
80x16 mm

Wundhaken für Mund-Kiefer-Gesicht
Retractors for Mouth-, Jaw- and Face Surgery
Separadores para cirugía plástica
Divaricatori per chirurgia plastica

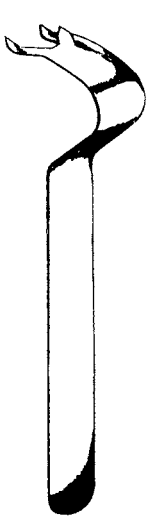


SPINA-NASALIS
49613-10
22 cm, 8 ³/₄"

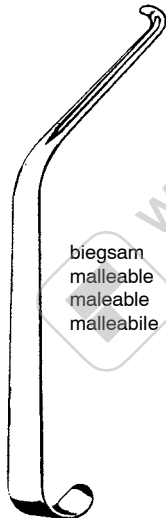


RAMUS
49615-12
22 cm, 8 ³/₄"

Wundhaken für Mund-Kiefer-Gesicht, Raspatorien
 Retractors for Mouth-, Jaw- and Face Surgery, Periosteal Elevators
 Separadores para cirugía plástica, Periostótomos
 Divaricatori per chirurgia plastica, Periostotomi



OBWEGESER
 49620-15
 15,5 cm, 6"

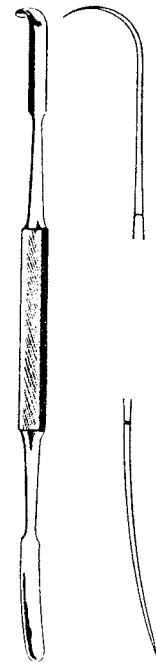


OBWEGESER
 49623-16
 16 cm, 6 1/4"

biegsam
 malleable
 maleable
 malleabile

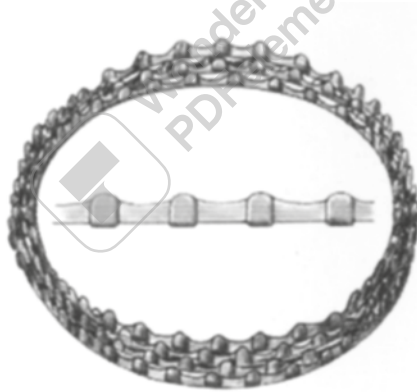


OBWEGESER
 49627-01
 21 cm, 8 1/4"



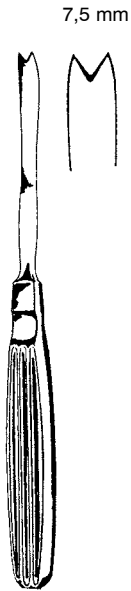
OBWEGESER
 49630-02
 20,5 cm, 8"

Drahtbogen
Wire Pushers
Empujadores de alambres
Posizionatori per filo



ERICH
49631-00
20,5 cm, 8"

Raspatorien Periosteal Elevators Periostótomos Periostotomi



OBWEGESER
49635-18
17,5 cm, 7"



OBWEGESER
49640-05 - 49640-09
20 cm, 8"

5 mm



49640-05

7 mm



49640-07

9 mm



49640-09



OBWEGESER
49650-06 - 49650-11
17,5 cm, 7"

6 mm



49650-06

7 mm



49650-07

9 mm



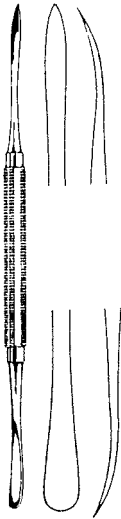
49650-09

11 mm

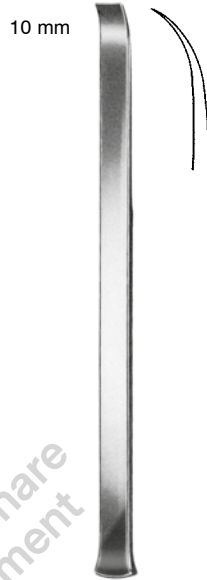


49650-11

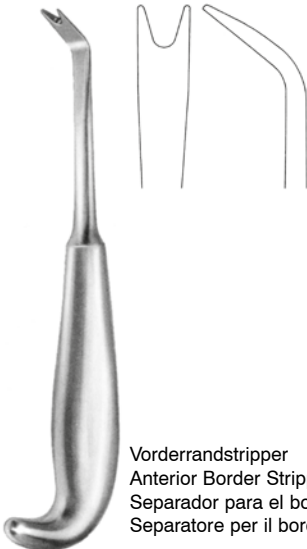
Elevator, Osteotom, Ahle
 Elevator, Osteotome, Awls
 Elevadores, Osteotomos, Agujas
 Elevatori, Osteotomo, Aghi



DINGMAN
 49660-18
 18 cm, 7"



OBWEGESER
 49665-24
 23,5 cm, 9 1/4"



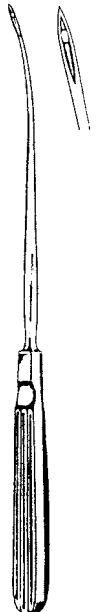
Vorderrandstripper
 Anterior Border Stripper
 Separador para el borde anterior
 Separatore per il bordo anteriore

HARGIS
 49670-19
 19 cm, 7 1/2"



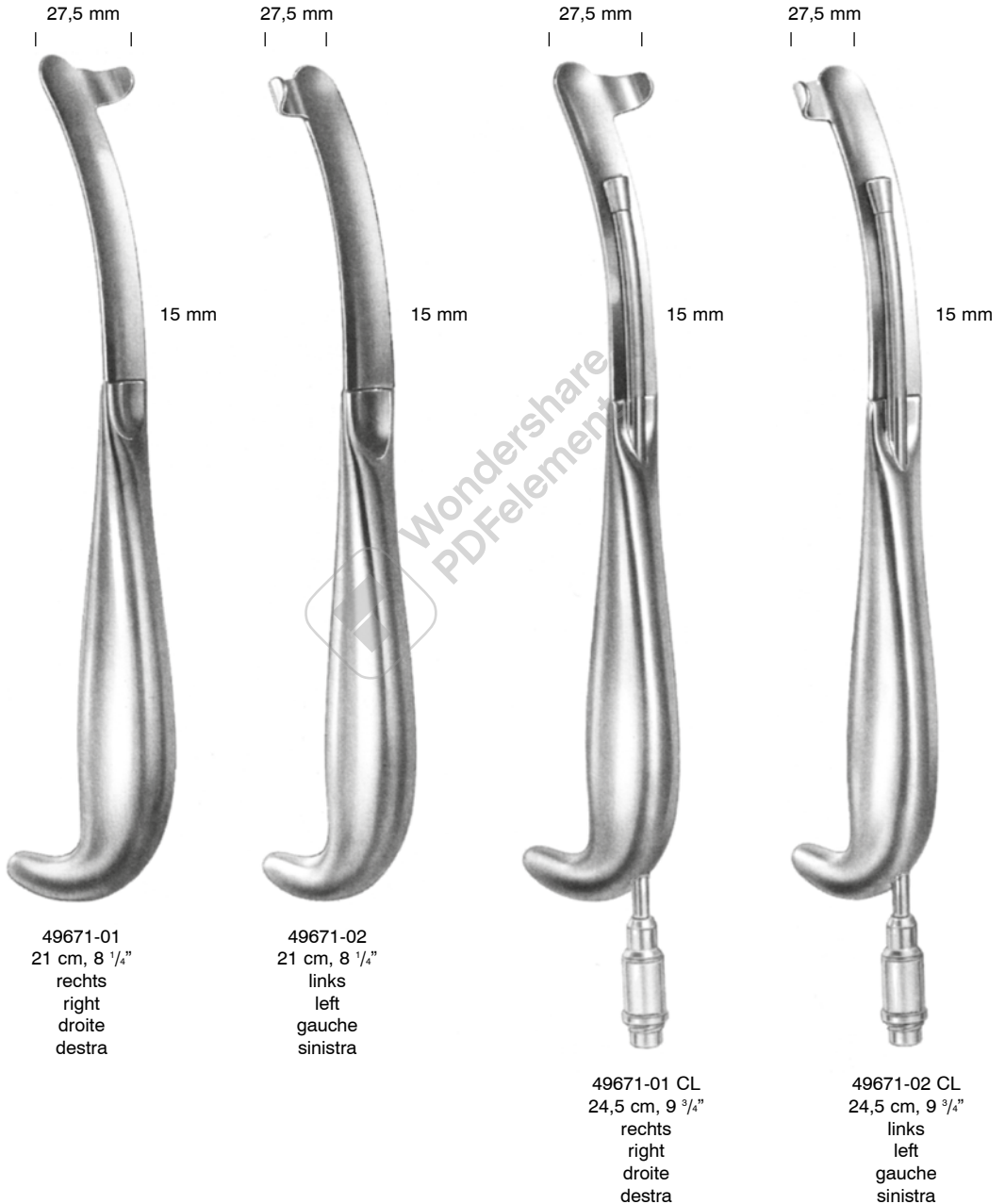
Spreizzange
 Ramus Separator
 Pinza para separar la rama
 Pinza per separare il ramo

SMITH
 49670-20
 23,5 cm, 9 1/4"



OBWEGESER
 49670-23
 23 cm, 9"

Intraorale Retraktoren
 Intra Oral Retractors
 Separadores intra orales
 Retrattori intraorali



Raspatorien
Periosteal Elevators
Legras
Elevatori per periostio



HARGIS
23 cm, 9"



49673-01
6,5 mm
rechts
right
derecha
destra



49673-02
9 mm
rechts
right
derecha
destra



49673-03
6,5 mm
links
left
izquierda
sinistra

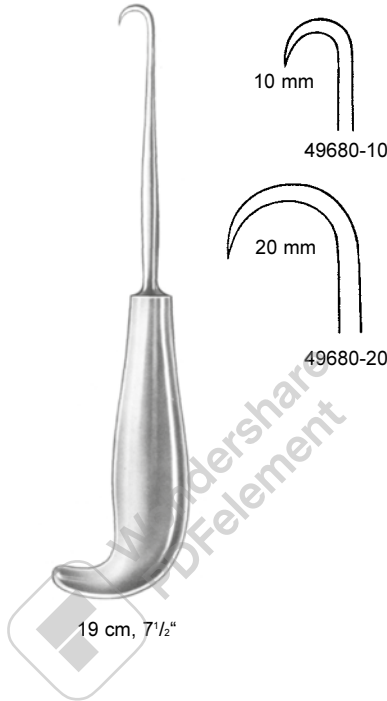


49673-04
9 mm
links
left
izquierda
sinistra

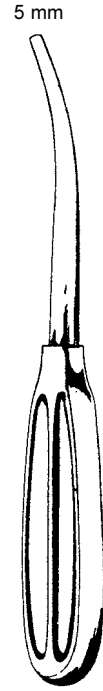
Ahle, Haken, Elevator
 Awls, Retractors for Mouth-, Jaw- and Face Surgery
 Aguja, Separadores para cirugía plástica
 Aghi, Divaricatori per chirurgia plastica



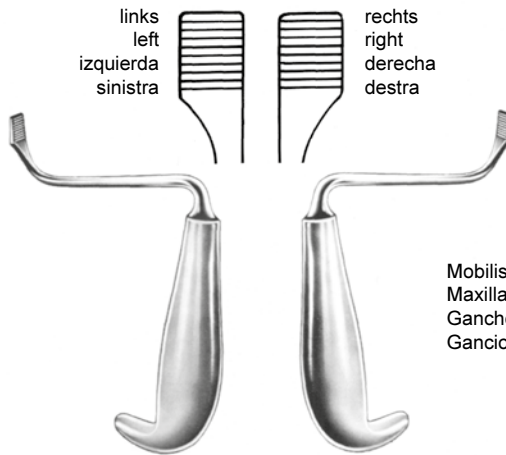
OBWEGESER
 49675-18
 18 cm, 7"



19 cm, 7 1/2"



DINGMAN
 49685-21
 21 cm, 8 1/4"

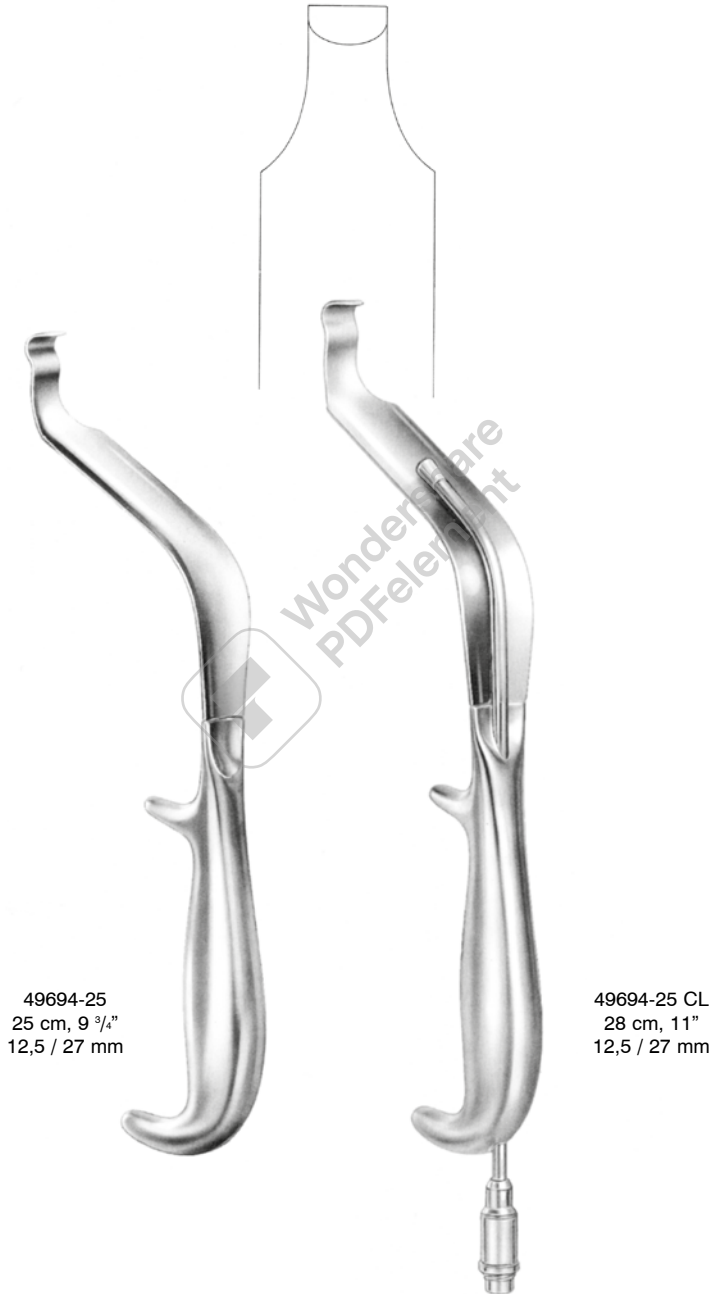


Mobilisierhaken
 Maxillary Mobilizer
 Gancho para movilización
 Gancio per mobilizzare

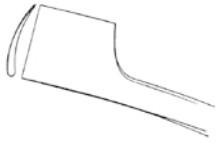
TESSIER
 49691-15 15 cm, 6"

TESSIER
 49692-15 15 cm, 6"

Intraorale Retraktoren
Intra Oral Retractors
Separadores intra orales
Retrattori intraorali



Sagittalspreizer
Sagittal Split Separators
Separadores sagitales
Separatori sagittali



rechts
right
derecha
destra

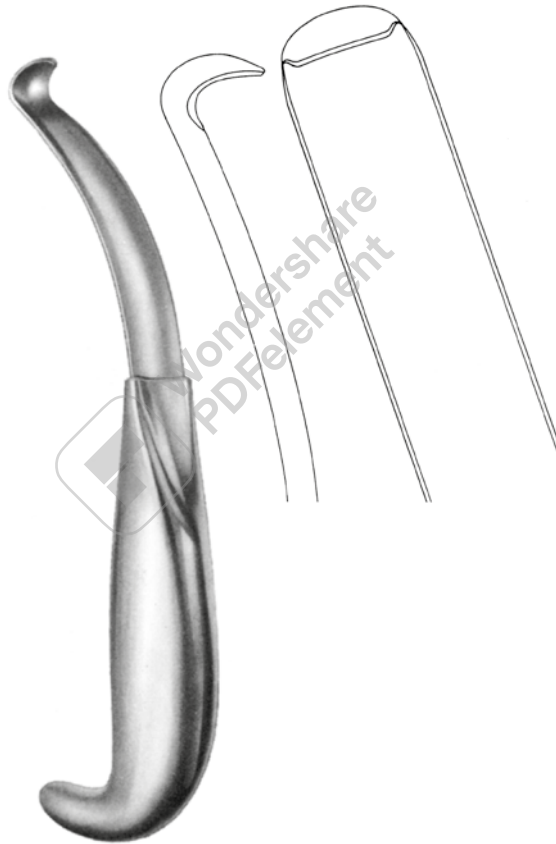
SMITH
49695-01
18,5 cm, 7 1/4"
9 mm



links
left
izquierda
sinistra

SMITH
49695-02
18,5 cm, 7 1/4"
9 mm

Unterkieferkörperhaken
Mandibular Body Retractor
Separador para el cuerpo mandibular
Separatore per il corpo mandibolare



HARGIS
49696-18
18 cm, 7"

Osteotome
Osteotome
Osteótomos
Osteotomi



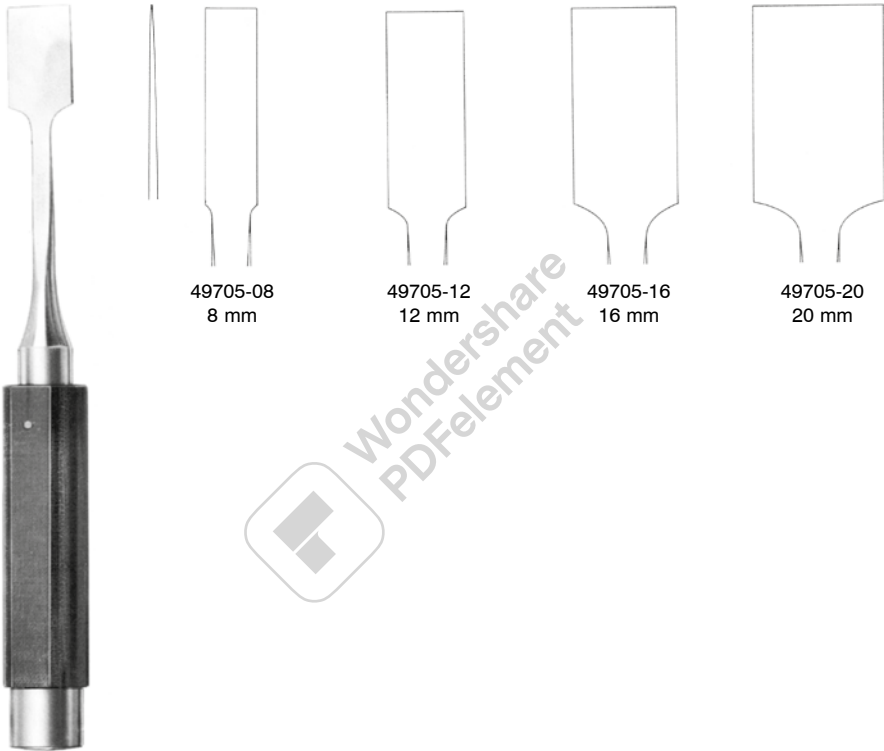
49700-01
21,5 cm, 8 1/2"



49700-02
21,5 cm, 8 1/2"

Wondershare
PDFelement

Blattosteotom
Blade Osteotomes
Osteótomos de hoja
Osteotomo a lama



OBWEGESER
22 cm, 8 3/4"

Osteotome
Osteotome
Osteótomos
Osteotomi



EPKER
18 cm, 7"



49710-04
4x1,2 mm



49710-06
6x1,2 mm



49710-08
8x1,2 mm



EPKER
18 cm, 7"



49711-04
4x1,2 mm



49711-06
6x1,2 mm



EPKER
18 cm, 7"



49713-06
6x1,2 mm

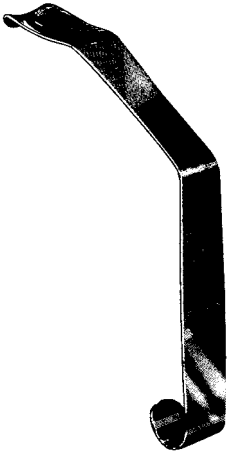


49713-08
8x1,2 mm

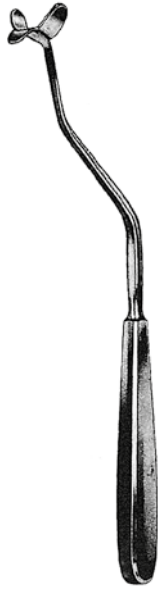


Wondershare
PDFElement

Wundhaken, Tonsillen-Elevatoren, Tamponstopfer
Retractors, Tonsil-Elevators, Gauze packer
Separadores, Elevadores para amígdalas, Tamponeador
Divaricatori, Elevatori, Tamponatore



LOVE 15 cm, 6"
51103-18 18 mm
51103-20 20 mm
51103-22 22 mm



HOFER
51109-24
24 cm, 9 1/2"



NAGER
51111-23
23 cm, 9"



HURD
51131-22
22 cm, 8 1/4"



LOPEZ-REINKE
51133-23
23 cm, 9"



YANKAUER
51134-21
21 cm, 8 1/4"



51135-01



HENKE
23 cm, 9"



51135-02



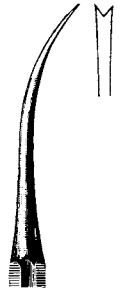
CARPENTER
51139-25
25 cm, 10"



CARPENTER
51143-24
24 cm, 9 1/2"



LUNIATSCHEK
51151-19
19 cm, 7 1/2"

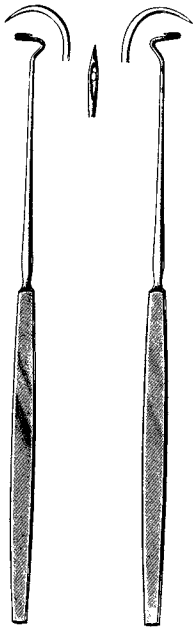


Tonsillen-Nadeln, Tonsillen-Messer

Tonsil Needles, Tonsil-Knives

Agujas para suturas de amígdalas, Bisturios para amígdalas

Aghi per tonsille, Coltelli per tonsille



DUPUY-WEISS
51165-22 51167-22
22 cm, 8 3/4"



CLAUS
51168-23
23 cm, 9"



CLAUS-EICKEN
51169-23
23 cm, 9"



NAGER
51170-24
24 cm, 9 1/2"



FISHER
51171-22
22,5 , 9"



ABRAHAM
51172-19
19 cm, 7 1/2"



ABRAHAM
51173-21
21 cm, 8 1/4"



CANFIELD
51174-21
21 cm, 8 1/4"



BRUENINGS
51177-23
23 cm, 9"

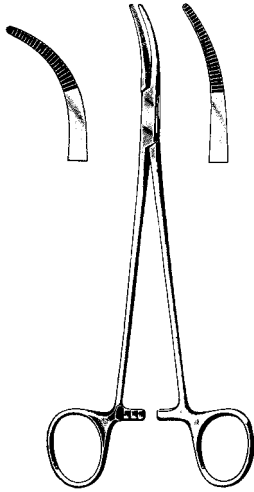


DOUGLAS
51178-21
21 cm, 8 1/4"

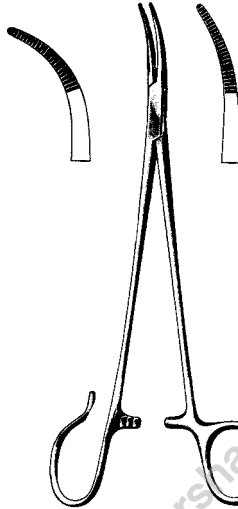


DOUGLAS
51179-17
17 cm, 6 3/4"

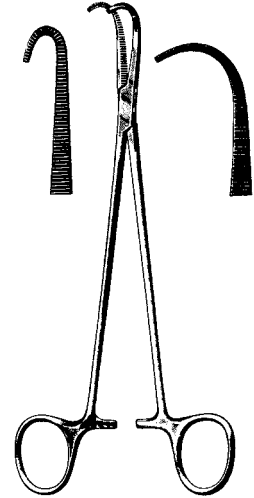
Tonsillenzange
Tonsil Seizing Forceps
Pinzas para coger las amígdalas
Pinze per tonsille



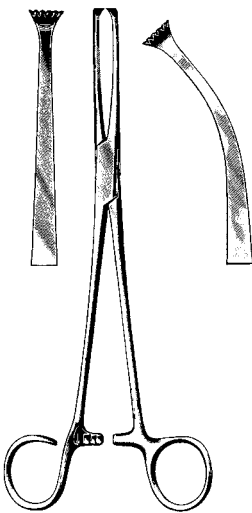
19 cm, 7 1/2"
SAWTELL SCHNIDT
51181-19 51183-19



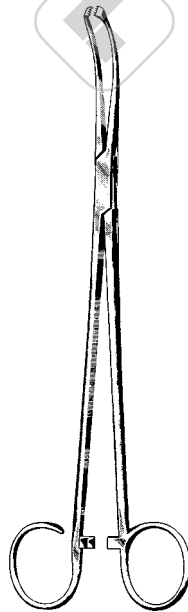
19 cm, 7 1/2"
SAWTELL SCHNIDT
51185-19 51187-19



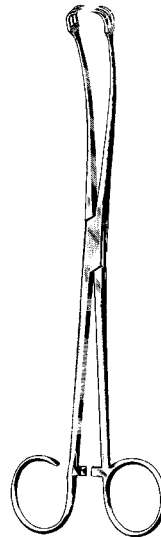
19 cm, 7 1/2"
NEGUS NEGUS
51191-19 51193-19



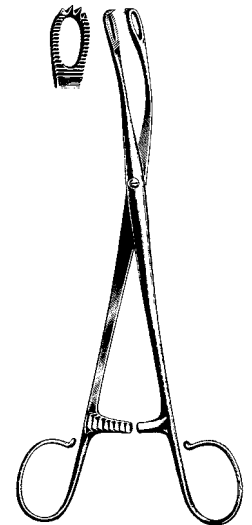
19 cm, 7 1/2"
COLVER
51202-19 51203-19



WHITE
51205-18 18 cm, 7"
51205-23 23 cm, 9"



BALLENGER
51207-21
21,5 cm, 8 1/2"

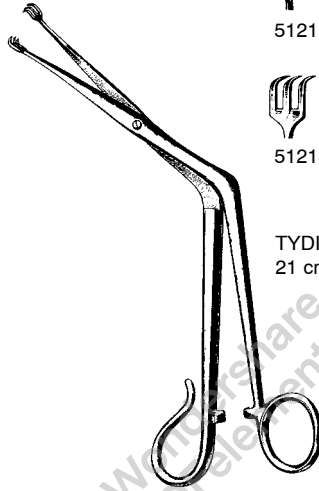


BLOHMKE
51209-20
20 cm, 8"

Tonsillen-Zangen u. -Pinzetten, Tonsillen-Kompressoren, Tonsillen-Schnürer
 Tonsil-Forceps, Tonsil-Snares
 Pinzas, Compresores para amígdalas, Cierra-nudos para amígdalas
 Pinze, Compressori per tonsille, Serranodi per tonsille



ABRAHAM
 51210-20
 20 cm, 8"

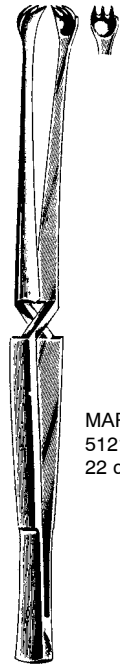


51211-21



51213-21

TYDING
 21 cm, 8 1/4"



MARSCHIK
 51219-22
 22 cm, 8 3/4"



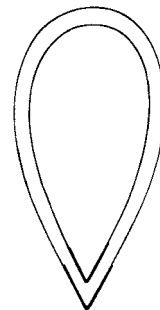
EVES
 51250-28
 28 cm, 11"



EVES
 51252-28
 28 cm, 11"



BRUENINGS
 51256-28
 28 cm, 11"

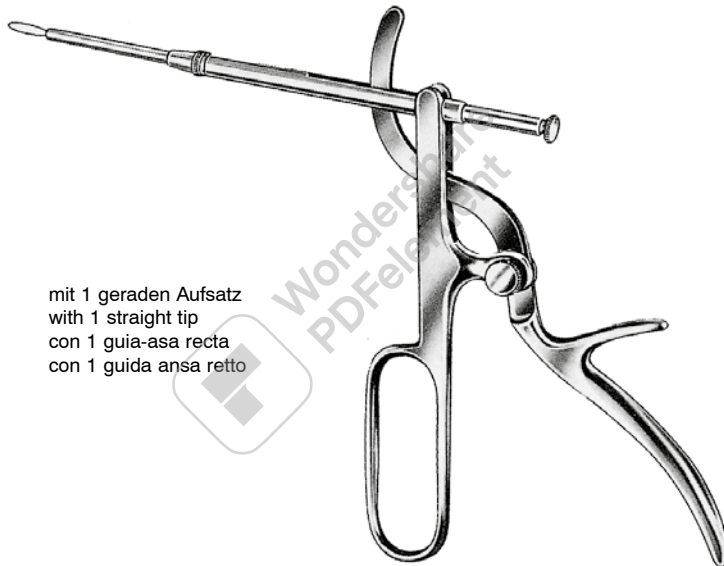


51257-40 40 mm
 51257-50 50 mm
 Pack of 100 pcs



51259-03 0,3 mm
 51259-04 0,4 mm
 51259-05 0,5 mm
 Pack of 12 pcs

Tonsillotom
Tonsillectomes
Amigdalótomos
Tonsillotomi



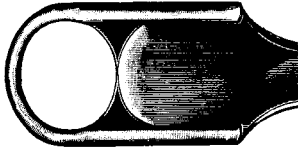
mit 1 geraden Aufsatz
with 1 straight tip
con 1 guida-asa recta
con 1 guida ansa retto

TYDING
51260-00

Tonsillotom, Spritzen, Septum Nadeln
Tonsillectomes, Syringes, Septum needles
Amigdalótomos, Jeringas, Septum aguja
Tonsillotomi, Siringhe, Septum aghi

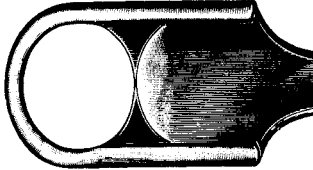
Aufsatz allein
blade only
hoja sola
lama sola

51270-01



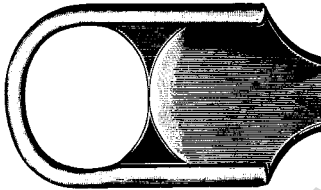
1

51270-02



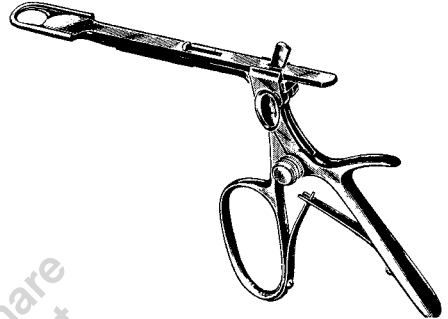
2

51270-03

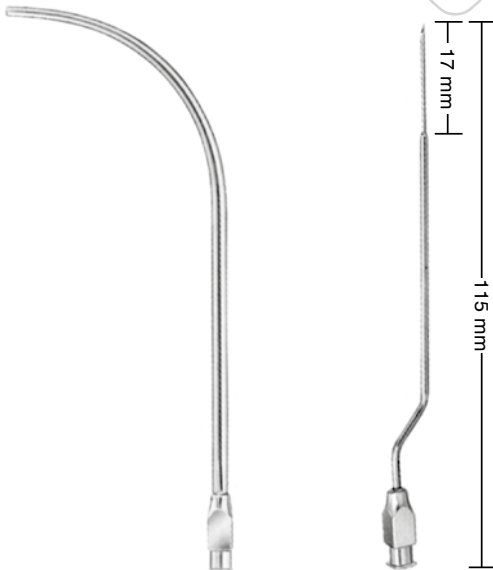


3

51270-04
Handgriff allein
Handle only
mango para
manipolo solo

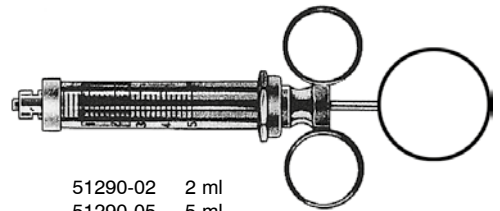


SLUDER-BALLENGER
51270-00
mit 3 Aufsätzen
with 3 blades
con 3 hojas
con 3 lame



51291-00
2,5 mm Ø

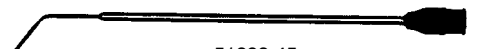
51293-00
0,8 mm Ø



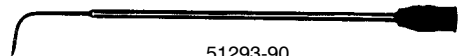
51290-02 2 ml
51290-05 5 ml
51290-10 10 ml
51290-20 20 ml



51292-00



51293-45
45°



51293-90
90°

Septum-Schere, Kehlkopfpolypenzangen, Deckelhalter
 Septum-Scissors, Laryngeal Polypus Forceps, Epiglottis Retractor
 Tijeras para septo, Pinzas para pólipos laríngeos, Depresor para epiglottis
 Forbice per il setto nasale, Pinze per polipi laringei, Depressore per epiglottide



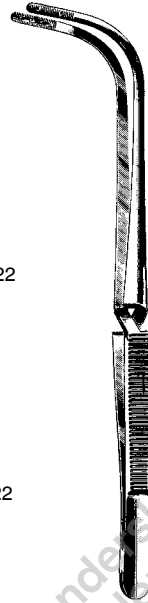
KILLIAN
 53102-20
 20 cm, 8"



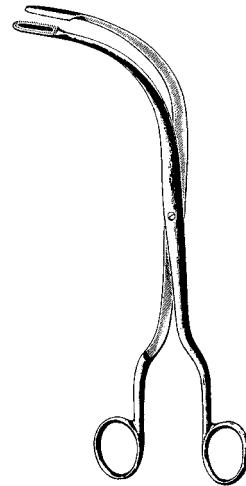
53101-22



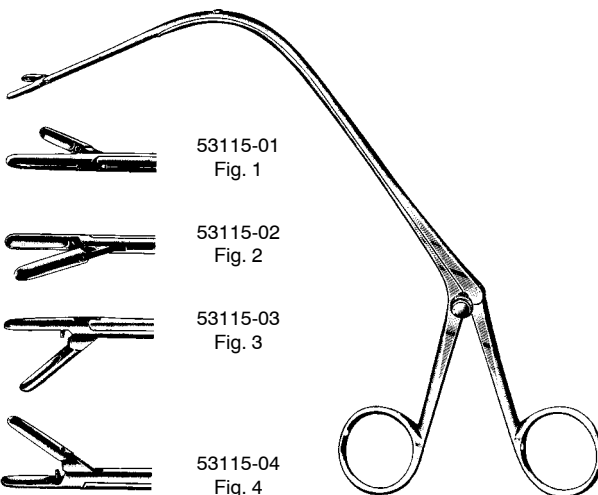
53103-22



JACKSON
 53101-22 - 53103-22
 22 cm, 8 3/4"



FRAENKEL
 53111-18
 18 cm, 7"



53115-01
 Fig. 1

53115-02
 Fig. 2

53115-03
 Fig. 3

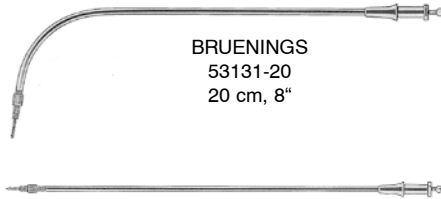
53115-04
 Fig. 4

JURASZ
 53115-01 - 53115-04
 23 cm, 9"



REICHERT
 53121-24
 24 cm, 9 1/2"

Universalgriffe, Verlängerungsrohre, Aufsätze
 Universal Handles, Interchangeable Tips, Tubes
 Mangos universales y Tubos de extension, Puntas
 Manici universali e Tubi di prolungamento, Terminale laringeo



BRUENINGS
 53131-20
 20 cm, 8"

BRUENINGS
 53132-20 20 cm, 8" 53132-50 50 cm, 19 3/4"
 53132-30 30 cm, 11 3/4" 53132-60 60 cm, 23 1/2"
 53132-40 40 cm, 15 3/4"



HUBER
 53130-00



FRAENKEL
 53150-00



SEIFERT
 53152-00



FRAENKEL
 53154-00



SCHEINMANN
 53155-00



SCHEINMANN
 53157-00



○ 53158-02
 ○ 53158-03
 BRUENINGS
 53158-02 - 53158-03

○ 53160-02

○ 53160-03



BRUENINGS
 53160-02 - 53160-03



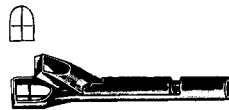
LANGE
 53162-00

⊕ 53164-01

⊕ 53164-02



KRAUSE
 53164-01 - 53164-02



KRAUSE
 53166-00



SCHUMACHER
 53170-00



BARACANI
 53175-00

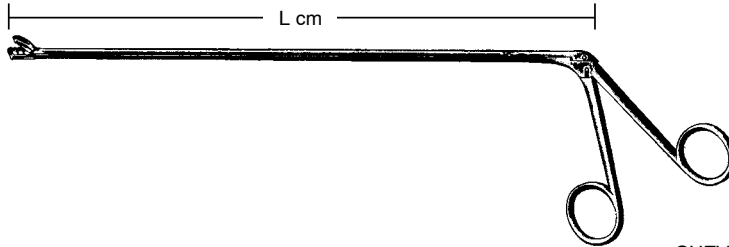
⊕ 53177-01

⊕ 53177-02



CORDES
 53177-01 - 53177-02

Broncho-Oesophagoskopiezangen, Kehlkopfspiegel, Griffe
 Broncho-Esophagscopy Forceps, Laryngeal Mirrors, Handles
 Pinzas para bronco-esofagoscopia, Espejos laringeos, Mangos
 Pinze per bronco-esofagoscopia, Specchi laringei, Manici



CHEVALIER-JACKSON
 53230-01 - 53260-08



cm	Fig. 1	Fig. 2	Fig. 3	Fig. 4	Fig. 5	Fig. 6	Fig. 7	Fig. 8
30/11 3/4"	53230-01	53230-02	53230-03	53230-04	53230-05	53230-06	53230-07	53230-08
40/15 3/4"	53240-01	53240-02	53240-03	53240-04	53240-05	53240-06	53240-07	53240-08
50/19 3/4"	53250-01	53250-02	53250-03	53250-04	53250-05	53250-06	53250-07	53250-08
60/23 1/2"	53260-01	53260-02	53260-03	53260-04	53260-05	53260-06	53260-07	53260-08

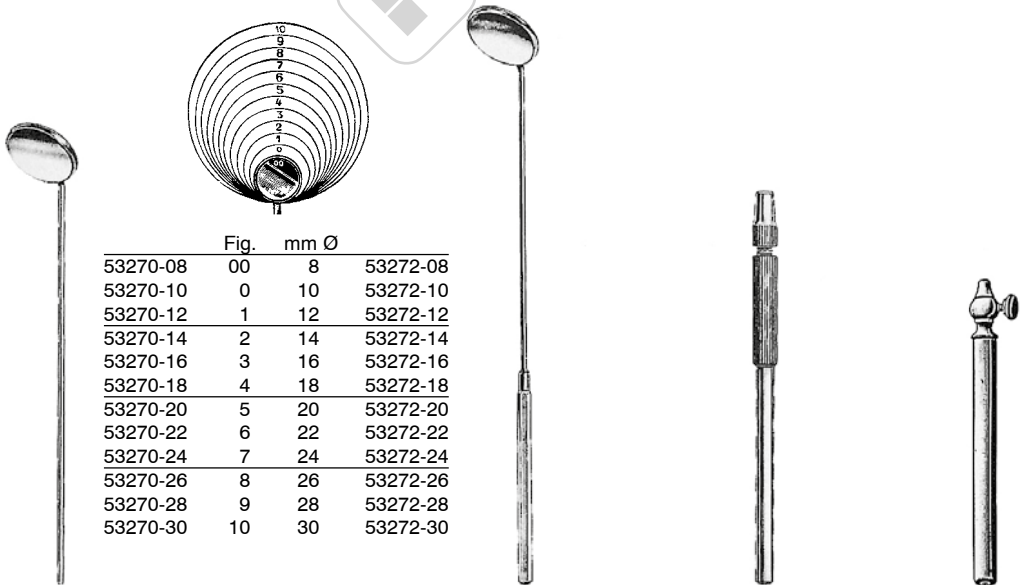


	Fig.	mm Ø	
53270-08	00	8	53272-08
53270-10	0	10	53272-10
53270-12	1	12	53272-12
53270-14	2	14	53272-14
53270-16	3	16	53272-16
53270-18	4	18	53272-18
53270-20	5	20	53272-20
53270-22	6	22	53272-22
53270-24	7	24	53272-24
53270-26	8	26	53272-26
53270-28	9	28	53272-28
53270-30	10	30	53272-30

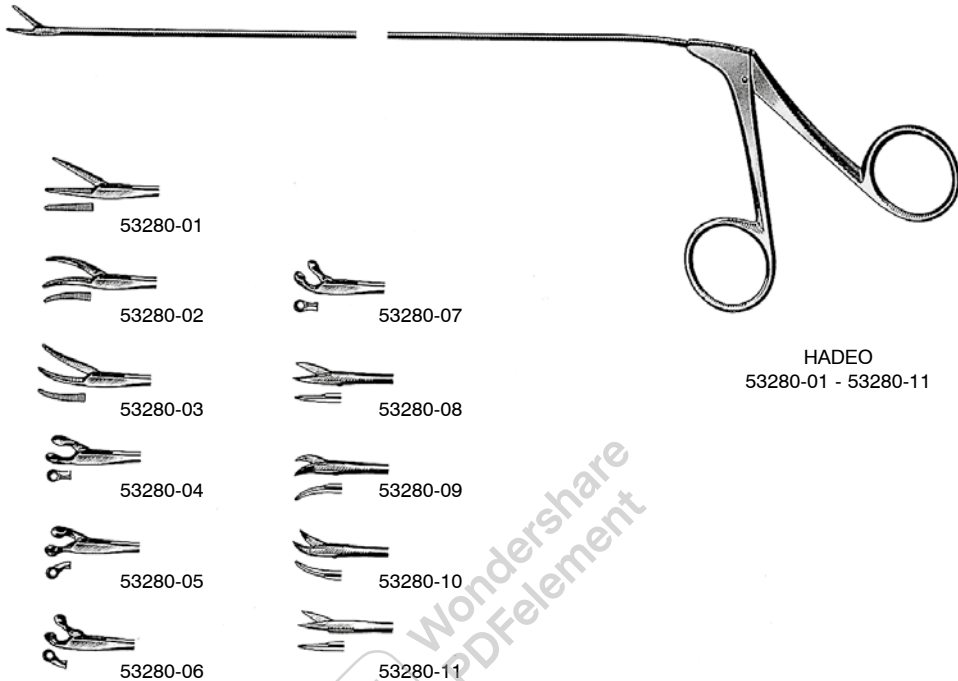
53270-08 - 53270-30

53272-08 - 53272-30

53274-12

53276-10

Mikro-Rohrschaftzangen
Micro Laryngeal Forceps
Pinzas para la micro-cirugía de la laringe
Pinze ad asta tubolare per microchirurgia



HADEO
53280-01 - 53280-11

HADEO Mikro-Rohrschaftzangen 22 cm (8 3/4'')

- 53280-01 gerieftes Maul, gerade 1,5 x 10 mm
- 53280-02 gerieftes Maul, links gebogen 1,5 x 8,5 mm
- 53280-03 gerieftes Maul, rechts gebogen 1,5 x 8,5 mm
- 53280-04 Löffelmaul, gerade 2,5 mm
- 53280-05 Löffelmaul, links abgewinkelt 2,5 mm
- 53280-06 Löffelmaul, rechts abgewinkelt 2,5 mm
- 53280-07 Löffelmaul, aufwärts abgewinkelt 2,5 mm
- 53280-08 Schere, gerade, vertikal
- 53280-09 Schere, links gebogen
- 53280-10 Schere, rechts gebogen
- 53280-11 Schere, horizontal schneidend, gerade

HADEO Pinza microlaringea 22 cm (8 3/4'')

- 53280-01 boca estriada recta 1,5 x 10 mm
- 53280-02 boca estriada curva a la izquierda 1,5 x 8,5 mm
- 53280-03 boca estriada curva a la derecha 1,5 x 8,5 mm
- 53280-04 boca redonda cortante recta 2,5 mm Ø
- 53280-05 boca redonda cortante angulada al la izquierda 2,5 mm Ø
- 53280-06 boca redonda cortante angulada a la derecha 2,5 mm Ø
- 53280-07 boca redonda cortante angulada hacia arriba 2,5 mm Ø
- 53280-08 Tijera recta corte vertical
- 53280-09 Tijera curva a la izquierda
- 53280-10 Tijera curva a la derecha
- 53280-11 Tijera recta corte horizontal

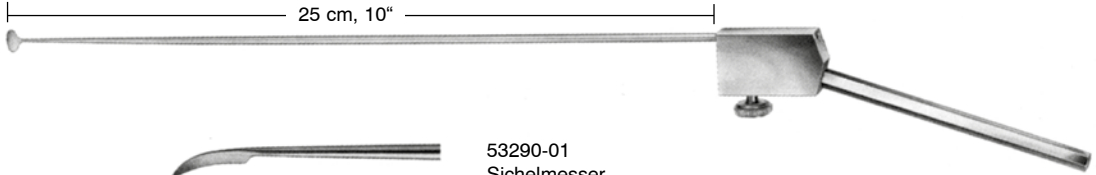
HADEO Micro-Laryngeal Forceps 22 cm (8 3/4'')

- 53280-01 Grasping tip, straight, serrated, 1,5 x 10 mm
- 53280-02 Grasping tip, curved to left, serrated, 1,5 x 8,5 mm
- 53280-03 Grasping tip, curved to right, serrated, 1,5 x 8,5 mm
- 53280-04 Cup forceps, straight, 2,5 mm
- 53280-05 Cup forceps, angled to left, 2,5 mm
- 53280-06 Cup forceps, angled to right, 2,5 mm
- 53280-07 Cup forceps, angled up, 2,5 mm
- 53280-08 Scissors, straight, vertical
- 53280-09 Scissors, curved to left
- 53280-10 Scissors, curved to right
- 53280-11 Scissors, straight, horizontal

HADEO Pinze ad asta tubolare per microchirurgia 22 cm (8 3/4'')

- 53280-01 morsi zigrinati, retti, 1,5 x 10 mm
- 53280-02 morsi zigrinati, curvi a sinistra, 1,5 x 8,5 mm
- 53280-03 morsi zigrinati, curvi a destra, 1,5 x 8,5 mm
- 53280-04 morsi a forma di cucchiaio rotondo retto, 2,5 mm
- 53280-05 morsi a forma di cucchiaio rotondo angolati a sinistra, 2,5 mm
- 53280-06 morsi a forma di cucchiaio rotondo angolati a destra, 2,5 mm
- 53280-07 morsi a forma di cucchiaio rotondo angolati in alto, 2,5 mm
- 53280-08 forbici, rette, taglio verticale
- 53280-09 forbici, curve a sinistra
- 53280-10 forbici, curve a destra
- 53280-11 forbici, rette, taglio orizzontale

Instrumente für Laryngoskopie
 Instruments for Laryngology
 Instrumentos Laringoscopia
 Strumenti per la Laringoscopia



53290-01
 Sichelmesser
 micro-laryngeal sickle
 microlaringeo cuchillo de hoz
 Coltello falcato



53290-02
 Schälmesser, quer, oval
 micro-laryngeal separador oval, horizontal
 microlaringeo separador ovalado, horizontal
 Separatore ovale verticale



53290-03
 Schälmesser, längs, oval
 micro-laryngeal separador oval, vertical
 microlaringeo separador ovalado, vertical
 Separatore ovale orizzontale



53290-04
 Schälmesser, 45° abgewinkelt
 micro-laryngeal round cutting knife, 45° angled
 microlaringeo cuchillo para cortes redondos, 45° angulado
 Separatore angolato 45°



53290-05
 Häkchen, 90° gebogen stumpf
 micro-laryngeal hook 90° angled, blunt
 microlaringeo ganchito 90° angulado, romo
 Uncino angolato 90° smusso



53290-06
 Häkchen, 30° retrograd gebogen
 micro-laryngeal probe, 30° backwards curved blunt with button
 microlaringeo ganchito, 30° curvo retrogrado
 Uncino angolato retrogrado 30°



53290-07
 Fadengabel
 micro-laryngeal ligatore adjuster
 microlaringeo horquilla de hilos
 Forchetta da sutura

53290-08
 Handgriff für Stabinstrumente
 Handle for microlaryngeal instruments
 Mango para microlaringeos instrumentos
 Manico per strumenti microlaringei

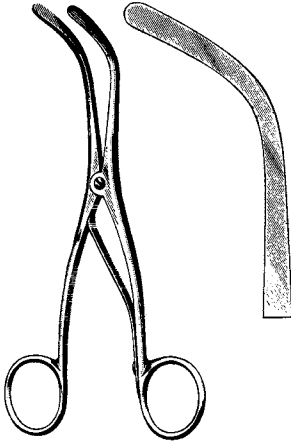


Tracheal Dilatoren, Trachealhaken, Tracheal-Wundspreizer

Trachea Dilators, Trachea hooks, Tracheal Retractors

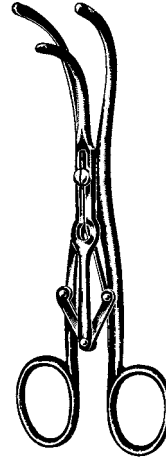
Dilatadores para la tráquea, Ganchos para traqueotomía, Retractor traqueal

Dilatatori per tracheotomia, Ganci per tracheotomia, Divaricatori tracheali



TROUSSEAU-BABY
55111-13 13 cm, 5 1/8"

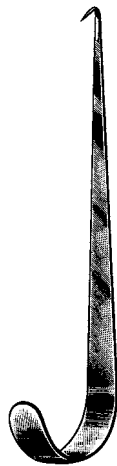
TROUSSEAU
55111-14 14 cm, 5 1/2"



LABORDE
55113-14
14 cm, 5 1/2"



BOSE
55115-07
7 cm, 2 3/4"



JACKSON
55116-15
15 cm, 6"



JACKSON
55117-17
17 cm, 6 3/4"

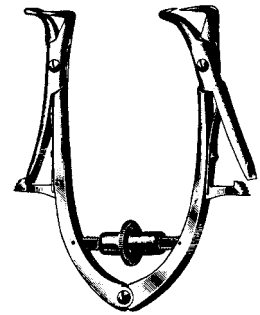
Trachealhaken, Kanüle
Trachea Hooks, Tubes
Ganchos para traqueotomía, Cánula
Ganci per tracheotomia, Cannule



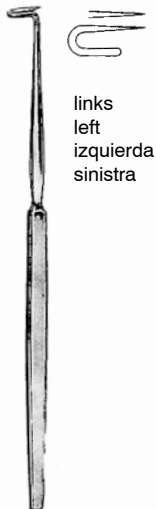
ITERSON
55118-16 - 55119-16
16 cm, 6 1/4"



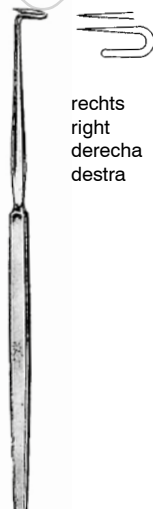
NEWS
55120-15
15 cm, 6"



FRIEDMANN
71351-10 10 cm, 4"
71351-15 15 cm, 6"



BOSE
55122-16
16 cm, 6 1/4"



BOSE
55124-16
16 cm, 6 1/4"



WAGENER-MOSHER
55151-05 5 mm
55151-07 7 mm
55151-09 9 mm

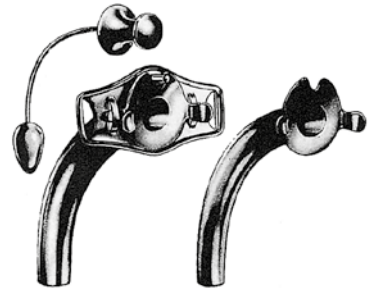


Tracheal-Kanülen, Schilddrüsenhaken, Sonde, Kropffaßzange, Muskelklemme
 Tracheal Tubes, Thyroid Gland Retractor, Directors-Enucleators, Goitre Seizing Forceps, Muscular Clamp
 Cánulas traqueales, Separador para la glándula tiroidea, Sondas,
 Pinza para coger el bocio, Pinza-clamp para músculos
 Cannule tracheali, Divaricatori per la tiroide, Sonde, Pinze per gozzo, Pinza muscolare



LUER

Neusilber
 German silver
 alpaca
 argentone



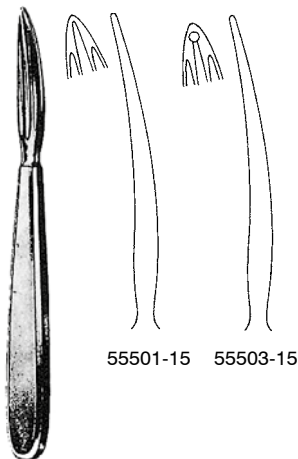
CHEVALIER-JACKSON

Neusilber
 German silver
 alpaca
 argentone

Fig.	Ø mm	Länge des Außenrohrs Length of outer tube Largo de la cánula exterior Lunghezza del tubo esterno
0	4	45 mm
1	5	50 mm
2	6	55 mm
3	7	60 mm
4	8	65 mm
5	9	70 mm
6	10	75 mm
7	11	80 mm
8	12	85 mm
9	13	90 mm

55220-04
 55220-05
 55220-06
 55220-07
 55220-08
 55220-09
 55220-10
 55220-11
 55220-12
 55220-13

55240-04
 55240-05
 55240-06
 55240-07
 55240-08
 55240-09
 55240-10
 55240-11
 55240-12
 55240-13



KOCHER
 55501-15 - 55503-15
 15 cm, 6"



SCHOENBORN
 55511-21
 21 cm, 8 1/4"



LAHEY
 55520-15 15 cm, 6"
 55520-20 20 cm, 8"

MASTIN
 55523-17
 17 cm, 6 3/4"

Rippenscheren
Rib Shears
Costótomos
Costotomi



COLLIN
57102-23
23 cm, 9"



57105-22
22 cm, 8 3/4"

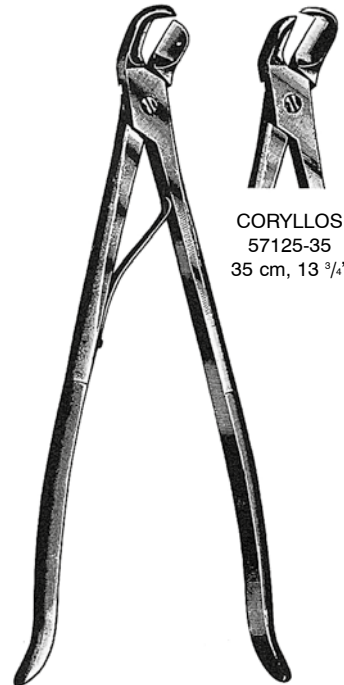


GLUCK
57107-22
22 cm, 8 3/4"

mit ziehendem Schnitt
with eccentric sliding blade
con hoja de retroacción
con lama di retroazione



STILLE
57111-21
21 cm, 8 1/4"



CORYLLOS
57123-35
35 cm, 13 3/4"

CORYLLOS
57125-35
35 cm, 13 3/4"

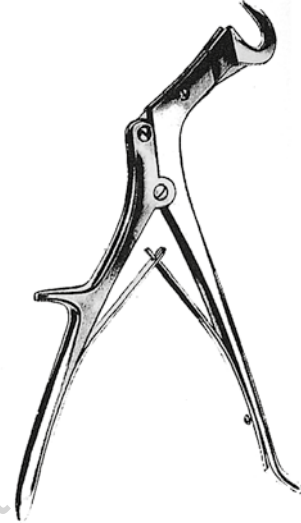
Rippenscheren, Sternumscheren
Rib Shears, Sternum Scissors
Costótomos, Tijeras de esternón
Costotomi, Forbici per sterno



BETHUNE
57126-34
34 cm, 13 1/2"



SAUERBRUCH
57131-26
26 cm, 10 1/4"



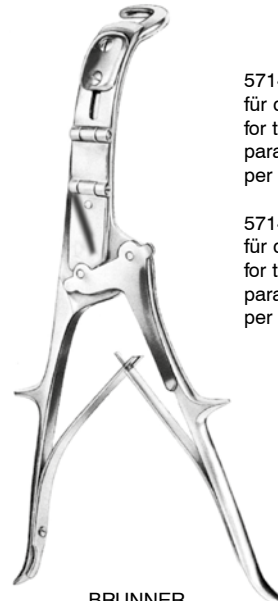
GIERTZ-STILLE
57137-27
27 cm, 10 1/2"



SCHUMACHER
57138-21
21 cm, 8 1/4"



SAUERBRUCH-FREY
57141-36
36 cm, 14.2"

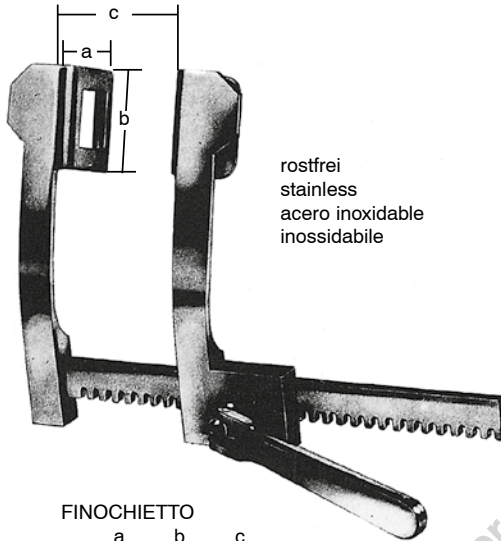


BRUNNER
57146-28 - 57147-28
28 cm, 11"

57146-28
für die rechte Hand
for the right hand
para la mano derecha
per la mano destra

57147-28
für die linke Hand
for the left hand
para la mano izquierda
per la mano sinistra

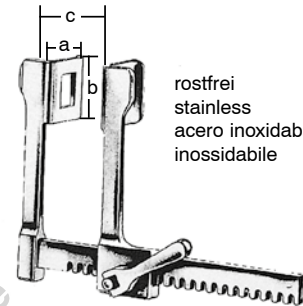
Rippensperrer
Rib Spreaders
Separadores costales
Divaricatori costali



rostfrei
stainless
acero inoxidable
inoxidabile

FINOCHIETTO

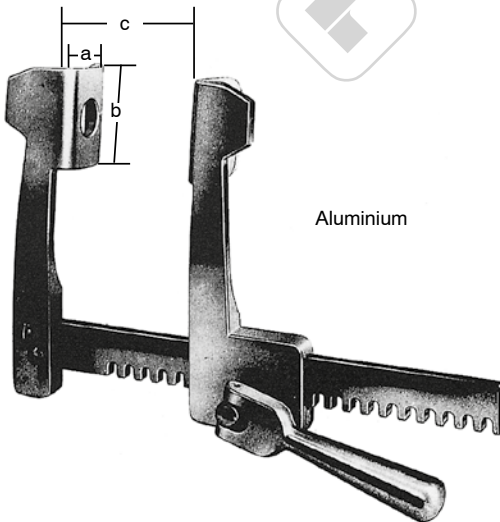
	a	b	c
	mm	mm	mm
57210-16	38	44	160
57210-20	52	62	200
57210-25	65	85	250



rostfrei
stainless
acero inoxidable
inoxidabile

FINOCHIETTO-BABY

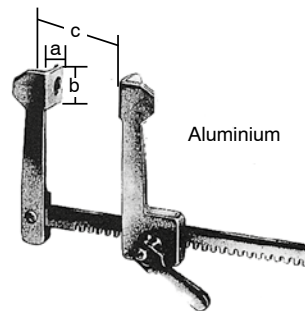
	a	b	c
	mm	mm	mm
57214-75	18	20	75



Aluminium

FINOCHIETTO

	a	b	c
	mm	mm	mm
57230-13	38	44	135
57230-17	52	62	175
57230-18	85	65	175



Aluminium

FINOCHIETTO-BABY

	a	b	c
	mm	mm	mm
57234-75	15	15	75

Rippensperrer
Rib Spreaders
Separadores costales
Divaricatori costali

FINOCHIETTO-BURFORD

	a	b	c
	mm	mm	mm
57236-20	65	62	200
	47	62	
57236-25	65	62	250
	47	62	
57236-30	65	62	300
	47	52	



rostfrei
stainless
acero inoxidable
inossidabile

Erwachsene
Adult Size
para adultos
per adulti

FINOCHIETTO-BURFORD

	a	b	c
	mm	mm	mm
57242-20	47	62	200
	65	62	
57242-25	47	62	250
	65	62	
57242-30	47	62	300
	65	62	



Aluminium

Kinder
Child Size
para niños
per bambini

FINOCHIETTO-BURFORD

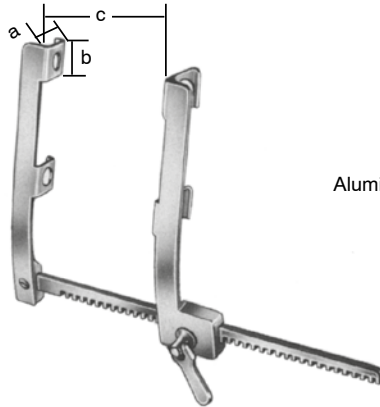
	a	b	c
	mm	mm	mm
57244-13	34	42	135
	48	42	



Aluminium

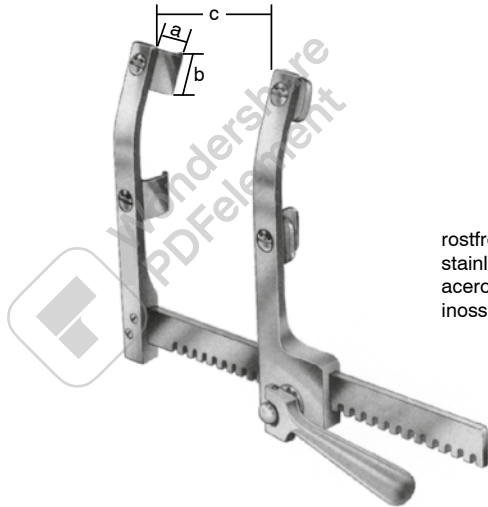
Rippensperrer
Rib Spreaders
Separadores costales
Divaricatori costali

FINOCHIETTO			
	a	b	c
	mm	mm	mm
57245-13	14	14	120



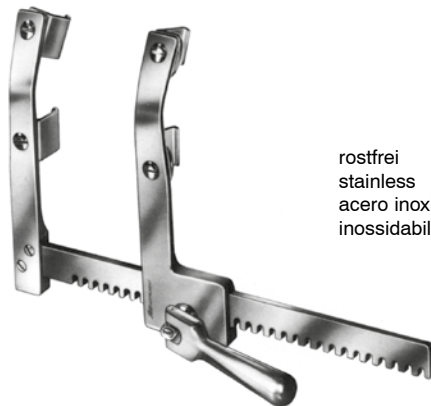
Aluminium

MORSE			
	a	b	c
	mm	mm	mm
57246-16	17	22	160



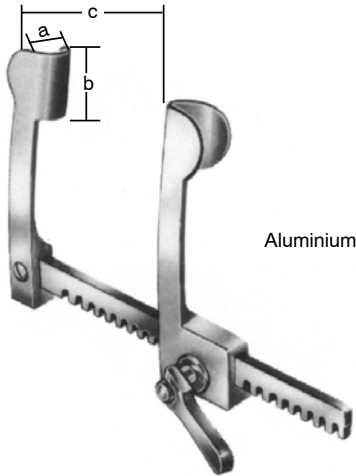
rostfrei
stainless
acero inoxidable
inossidabile

MORSE-FAVALORO			
	a	b	c
	mm	mm	mm
57246-21	19	27	210



rostfrei
stainless
acero inoxidable
inossidabile

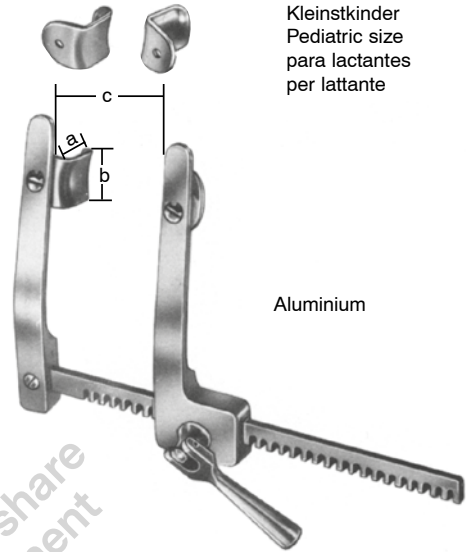
Rippensperrer
Rib Spreaders
Separadores costales
Divaricatori costali



Aluminium

COOLEY-NEONATAL

	a	b	c
	mm	mm	mm
57247-95	12	16	95

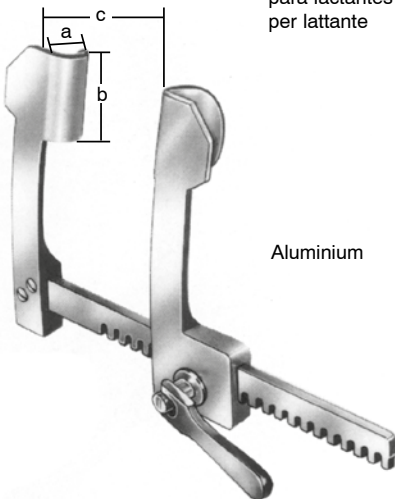


Kleinstkinder
Pediatric size
para lactantes
per lattante

Aluminium

COOLEY

	a	b	c
	mm	mm	mm
57249-01	10	14	90



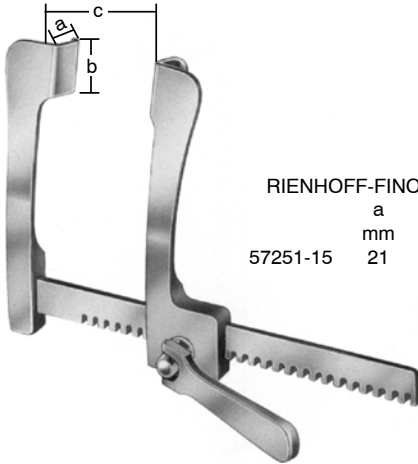
Kleinstkinder
Pediatric size
para lactantes
per lattante

Aluminium

COOLEY

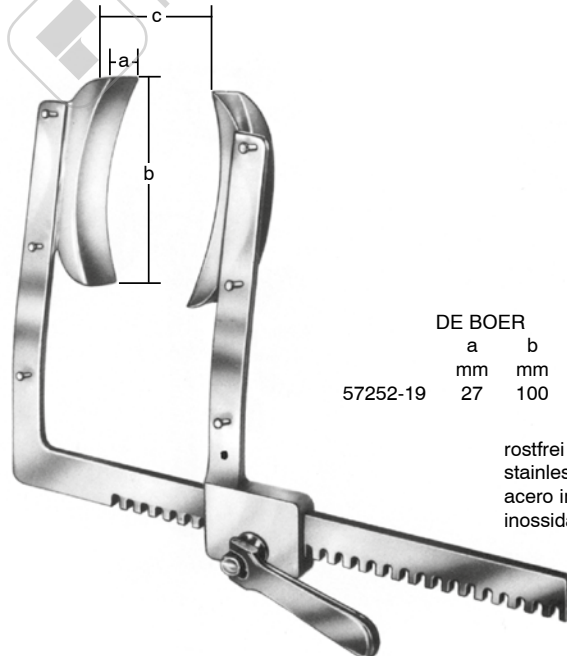
	a	b	c
	mm	mm	mm
57248-14	15	30	140

Rippensperrer
Rib Spreaders
Separadores costales
Divaricatori costali



	a	b	c
	mm	mm	mm
57251-15	21	26	150

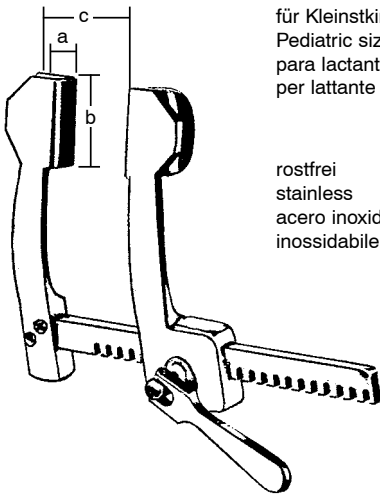
rostfrei
stainless
acero inoxidable
inossidabile



	a	b	c
	mm	mm	mm
57252-19	27	100	190

rostfrei
stainless
acero inoxidable
inossidabile

Rippensperrer
Rib Spreaders
Separadores costales
Divaricatori costali

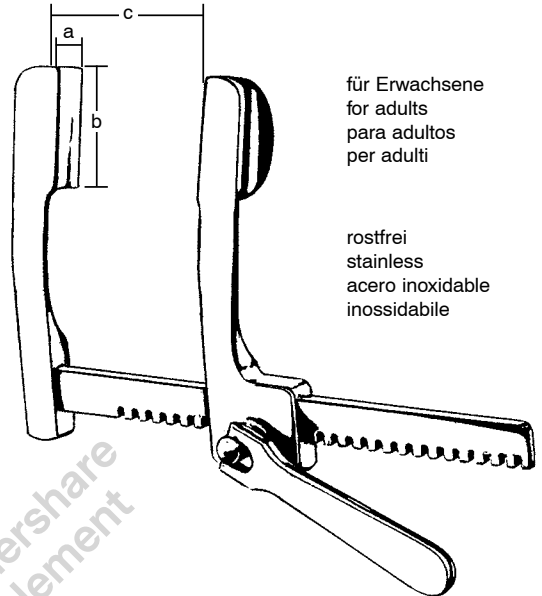


für Kleinstkinder
Pediatric size
para lactantes
per lattante

rostfrei
stainless
acero inoxidable
inossidabile

COOLEY

	a	b	c
	mm	mm	mm
57260-02	16	30	105
57260-03	21	44	150

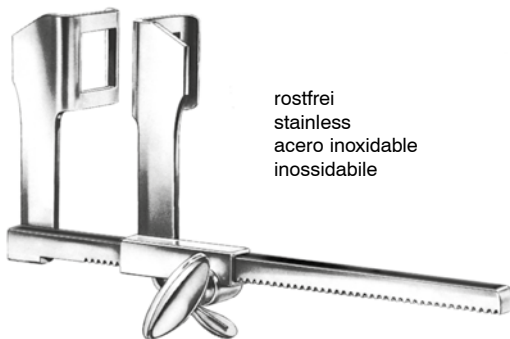


für Erwachsene
for adults
para adultos
per adulti

rostfrei
stainless
acero inoxidable
inossidabile

COOLEY

	a	b	c
	mm	mm	mm
57260-04	37	49	200



rostfrei
stainless
acero inoxidable
inossidabile

HAIGHT

	a	b	c	h
	mm	mm	mm	mm
57260-06	30	30	90	65
57260-09	30	30	90	90

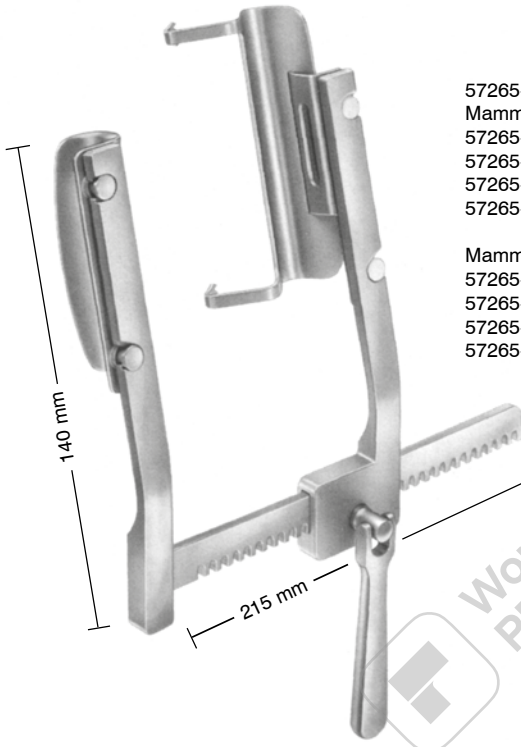


rostfrei
stainless
acero inoxidable
inossidabile

TUFFIER

	a	b	c
	mm	mm	mm
57264-16	50	45	165

Sternum-Sperrer Sternum Retractors



57265-00

Mammaria Sperrer, komplett bestehend aus:

57265-10 Sperrer allein

57265-20 Mammariablatt, komplett mit Aufnahmeblatt links und rechts

57265-30 1 Paar Sternumblätter 30x100 mm

57265-40 1 Paar Sternumblätter 40x100 mm

Mammaria spreader, complete consisting of:

57265-10 Retractor only

57265-20 Mammariablade complete with holding blades left and right

57265-30 1 pair of sternum blades 30x100 mm

57265-40 1 pair of sternum blades 40x100 mm



57265-20

Mammariablatt, komplett
Mammariablade, complete



57265-30

Sternumblätter 30x100 mm
Sternum blades 30x100 mm

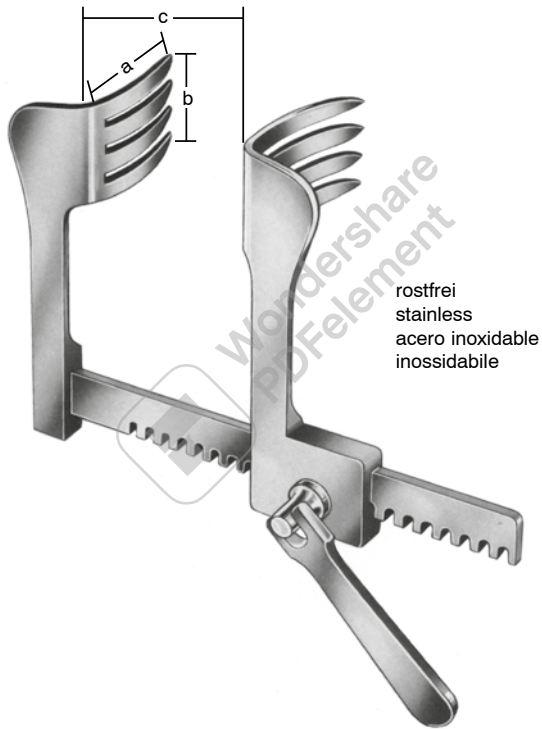


57265-40

Sternumblätter 40x100 mm
Sternum blades 40x100 mm



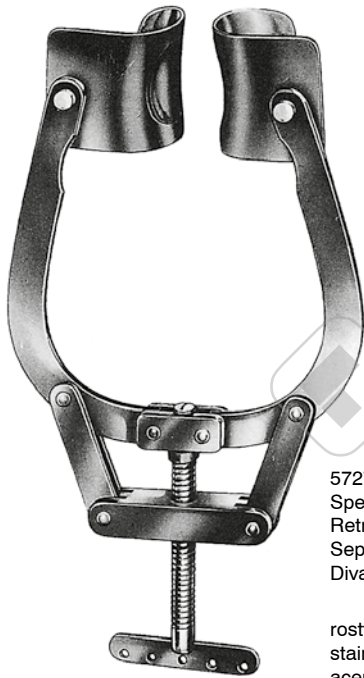
Laminektomie-Sperrer
Laminectomy-Retractor
Separadores para laminectomía
Divaricatori Laminectomia



CHERRY

	a	b	c
	mm	mm	mm
57266-13	44	70	135

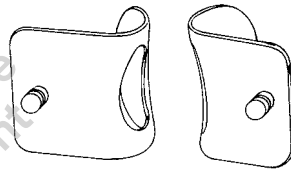
Thoraxsperrer
Thoracic retractor
Separador torácico
Divaricatore per il torace



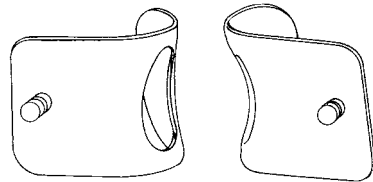
MERCEDES compl.
57270-00

57270-80
Sperrer allein
Retractor only
Separador solo
Divaricatore solo

rostfrei
stainless
acero inoxidable
inossidabile

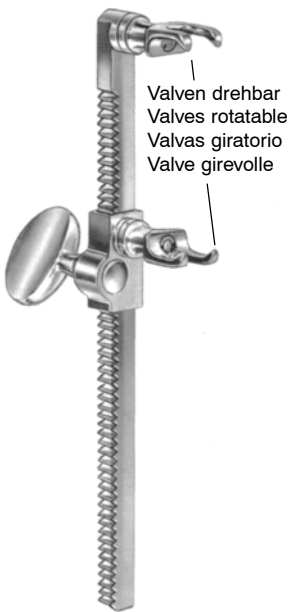


57270-65
42x65 mm

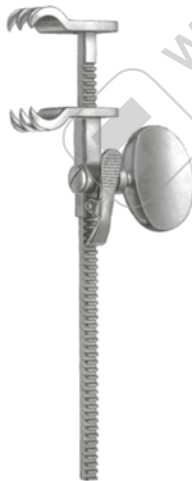


57270-75
75x75 mm

Rippenkonraktoren
Rib Contractors
Aproximadores para costillas
Aprossimatori costali



SELLORS
57280-19
20 cm, 8"



BAILEY-BABY
57283-14
14 cm, 5 1/2"



BAILEY
57284-16
16 cm, 6 1/4"

kurze Klauen
short claws
garras cortas
pinze corte



BAILEY-GIBBON
57286-16
16 cm, 6 1/4"

lange Klauen
long claws
garras largas
pinze lunghe

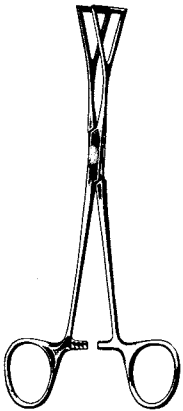
Lungenspatel
Lung Spatulas
Espátulas pulmonares
Spatole per polmone



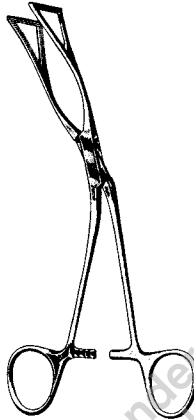
57288-30
30 cm, 11 ³/₄"

ALLISON
57289-32
32 cm, 12 ³/₄"

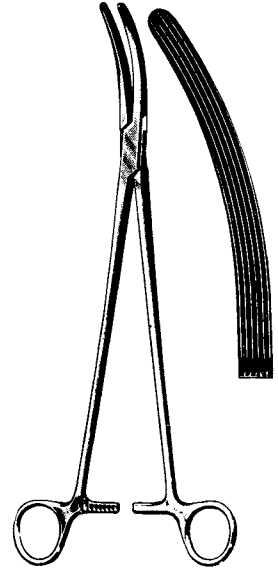
Lungenfaßzange, Bronchusklemmen
 Lung Grasping Forceps, Bronchus Forceps
 Pinzas para coger el pulmón, Pinzas clamps bronquiales
 Pinze per afferrare il polmone, Pinze per bronchi



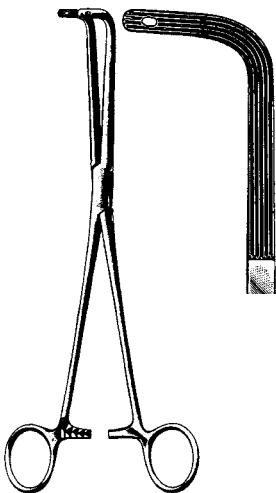
LOVELACE
 57290-20
 20 cm, 8"



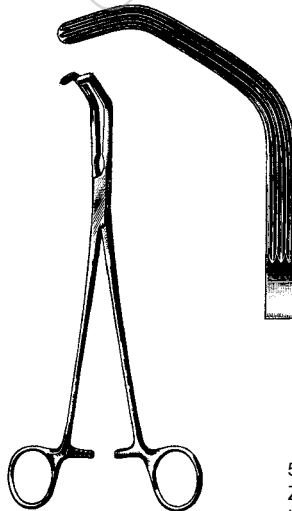
LOVELACE
 57291-20
 20 cm, 8"



HARRINGTON
 57301-30
 30,5 cm, 12"

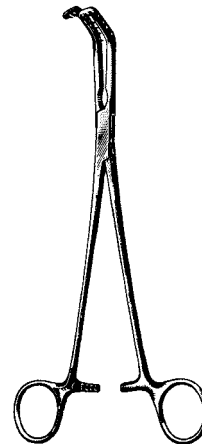


FINOCIETTO
 57307-24
 24 cm, 9 1/2"



PRICE-THOMAS
 57309-22
 22 cm, 8 3/4"

57311-22
 Zähne links
 tooth left
 dientes izquierda
 denti sinistro



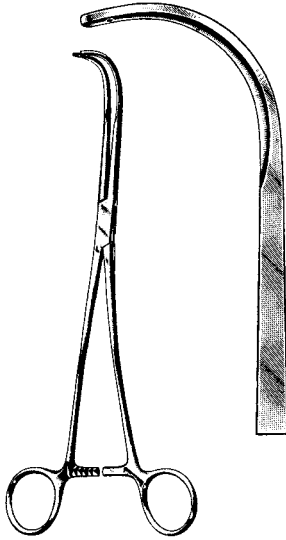
PRICE-THOMAS
 22 cm, 8 3/4"

57313-22
 Zähne rechts
 tooth right
 dientes derecha
 denti destro

Bronchusklemmen, Gefäßklemmen
 Bronchus Forceps, Blood Vessel Clamps
 Pinzas clamps bronquiales, Pinzas-clamps para vasos
 Pinze per bronchi, Pinze cardiovascolari

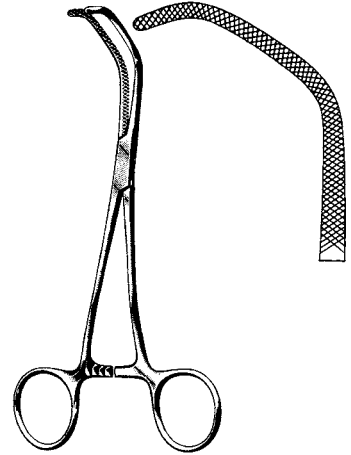


57321-23

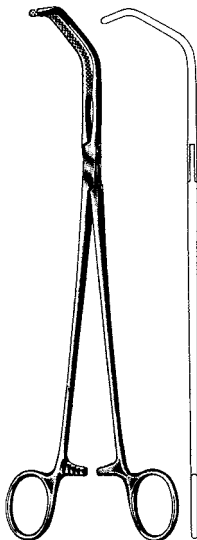


SEMB
 23 cm, 9"

57323-23



SATINSKY
 57325-15
 15 cm, 6"



SATINSKY
 57327-26 - 57329-26
 26 cm, 10 1/4"

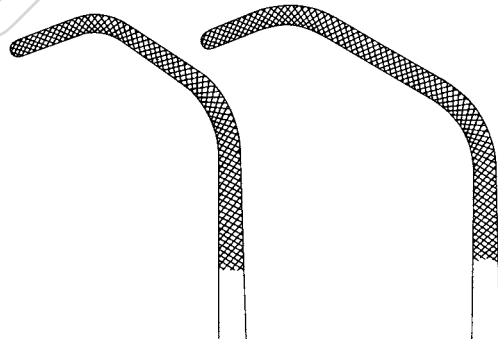


Fig. 1 57327-26

Fig. 2 57329-26

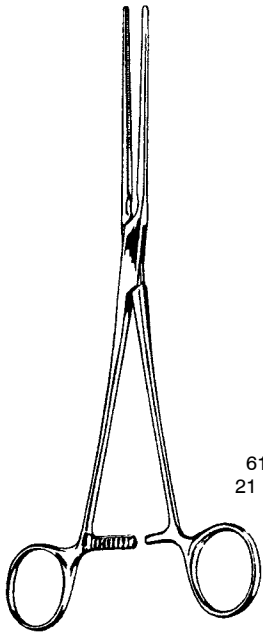
Atrauma

Coarctations-Klemmen

Coarctation clamps

Pinzas clamps para coartación

Pinza per coartazione

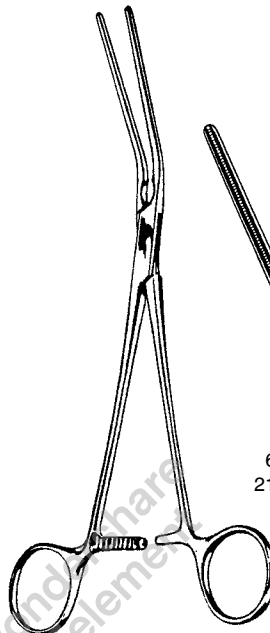


POTTS
61000-21 - 61000-22

61000-21
21 cm, 8 1/4"



61000-22
22 cm, 8 3/4"

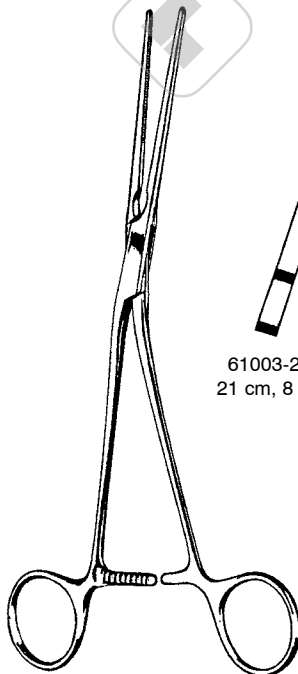


POTTS
61001-21 - 61001-22

61001-21
21 cm, 8 1/4"

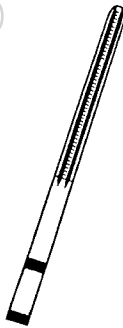


61001-22
22 cm, 8 3/4"

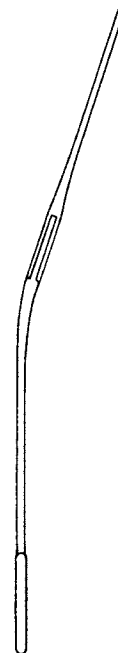
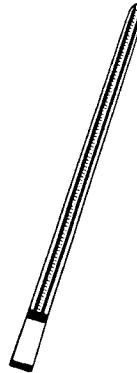


POTTS
61003-21 - 61003-22

61003-21
21 cm, 8 1/4"

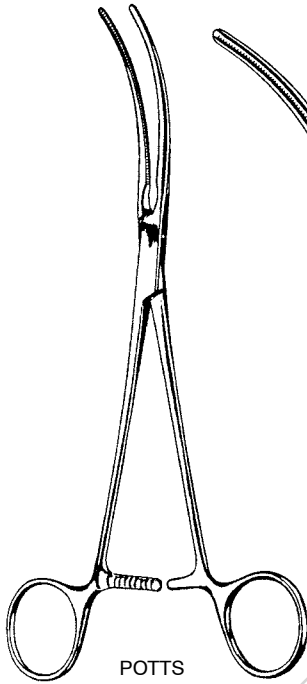


61003-22
22 cm, 8 3/4"

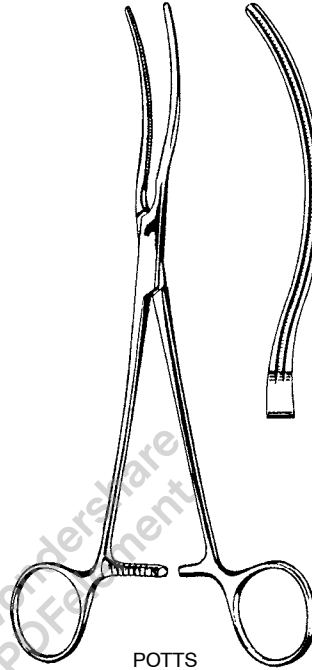
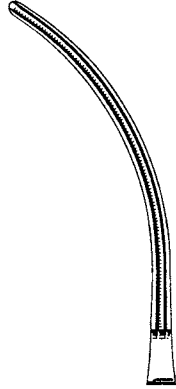


Atrauma

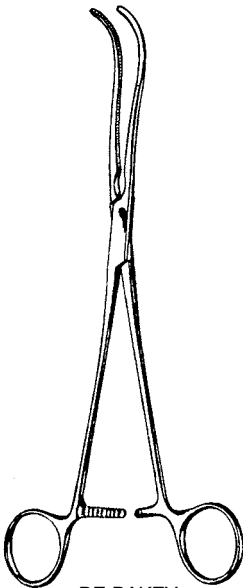
Anastomosen-Klemmen, Präparier- und Ligaturklemmen
 Anastomosis clamps, Dissecting and ligature forceps
 Pinzas clamps para anastomosis, Pinzas para preparaciones y ligaduras
 Pinze per anastomosi, Pinze per preparazioni e legature



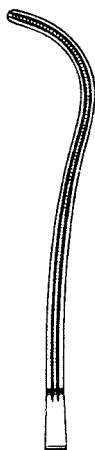
POTTS
 61005-22
 22 cm, 8 3/4"



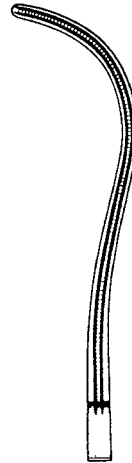
POTTS
 61007-22
 22 cm, 8 3/4"



DE BAKEY
 61008-19 - 61008-23



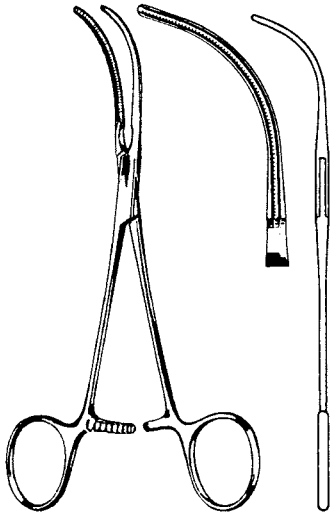
61008-19
 19 cm, 7 1/2"



61008-23
 23 cm, 9"

Atrauma

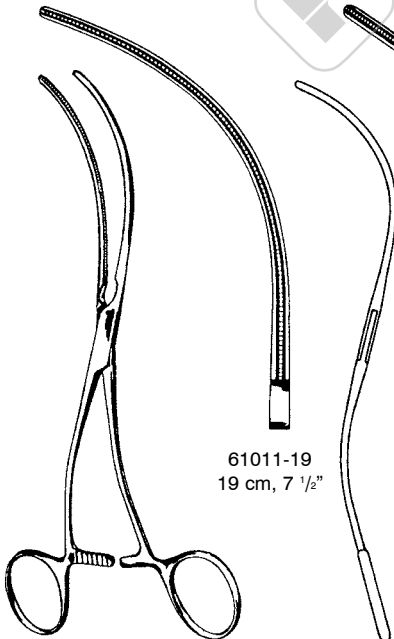
Peripheral-Gefäßklemmen
 Peripheral vascular clamps
 Pinzas-clamps para vasos periféricos
 Pinze vascolari periferici



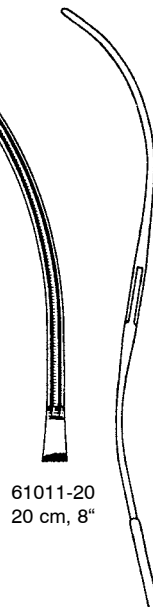
DE BAKEY
 61009-16
 16 cm, 6 1/4"



DALE
 61010-18
 18 cm, 7"



61011-19
 19 cm, 7 1/2"



61011-20
 20 cm, 8"

DE BAKEY
 61011-19 - 61011-20

Atrauma

Peripheral-Gefäßklemmen
 Peripheral vascular clamps
 Pinzas-clamps para vasos periféricos
 Pinze vascolari periferici



DALE

61012-17
 17,5 cm, 7"



61012-18
 18 cm, 7"



61012-19
 18,5 cm, 7 1/4"

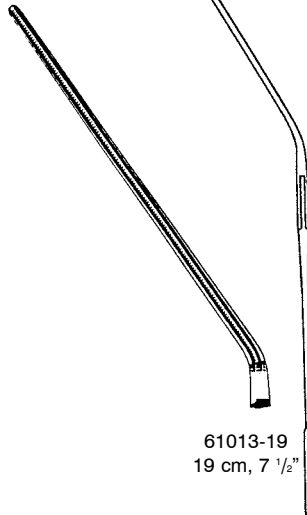


LELAND-JONES
 61013-18 - 61013-20

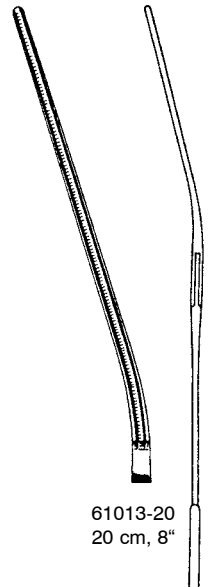
61013-18
 18 cm, 7"



61013-19
 19 cm, 7 1/2"

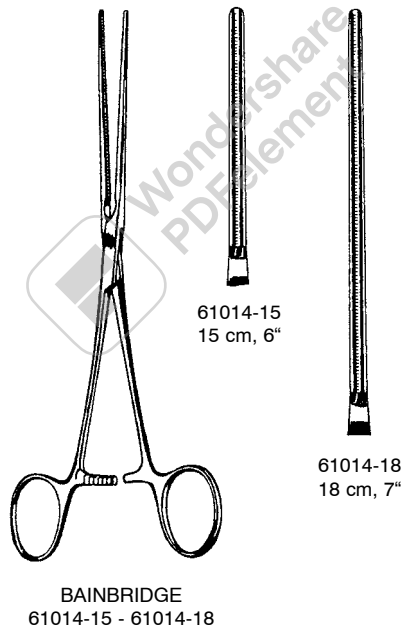


61013-20
 20 cm, 8"



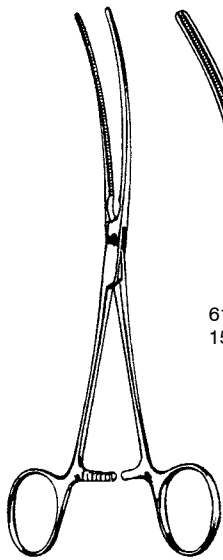
Atrauma

Mehrzweck-Gefäßklemme
Multi Purpose Vascular Clamps
Pinzas vasculares de usos multiples
Pinze vascolari universali

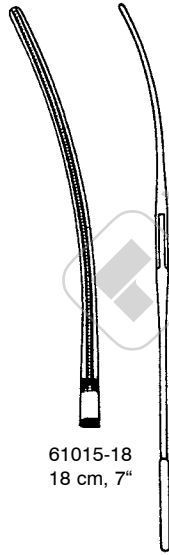


Atrauma

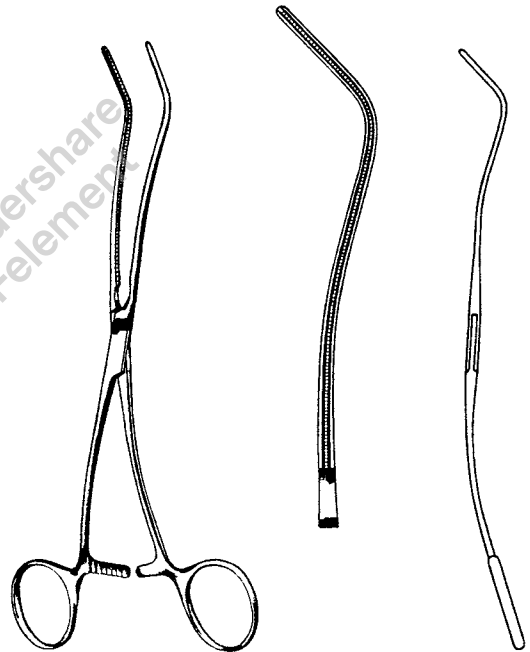
Mehrzweck-Gefäßklemme
Multi Purpose Vascular Clamps
Pinzas vasculares de usos multiples
Pinze vascolari universali



61015-15
15 cm, 6"



61015-18
18 cm, 7"

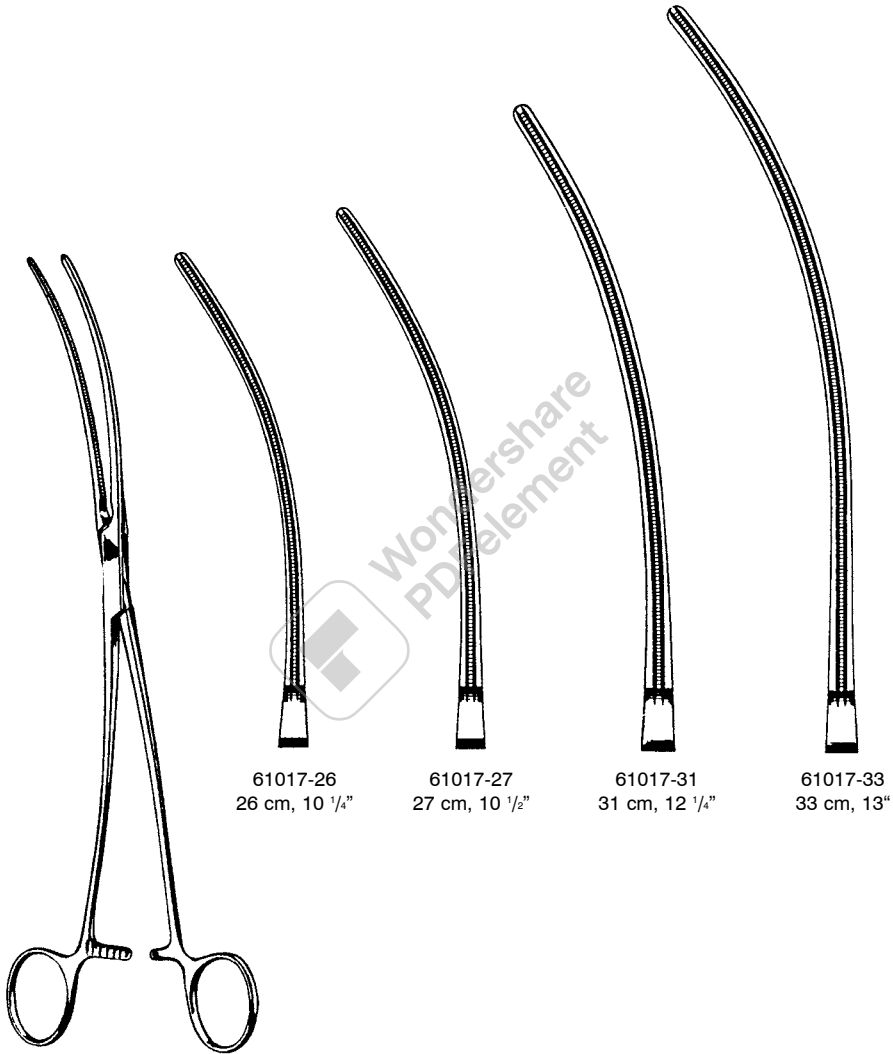


DE BAKEY
61016-20
20 cm, 8"

BAINBRIDGE
61015-15 - 61015-18

Atrauma

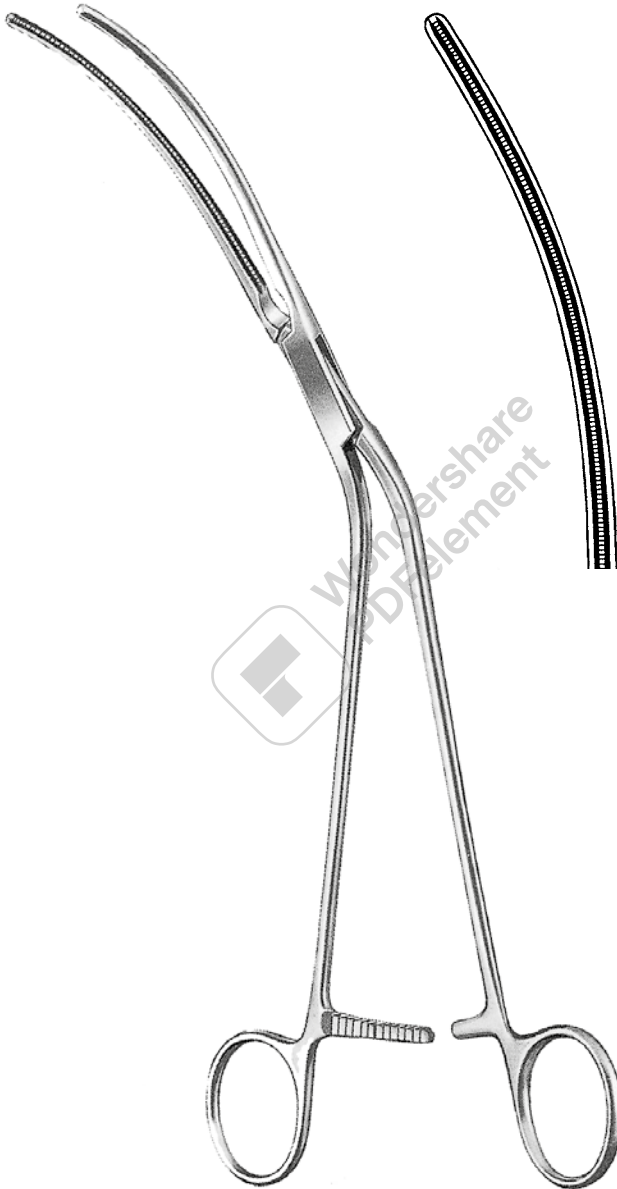
Aorta-Aneurysmaklemmen
Aortic aneurysm clamps
Pinzas-clamps para aneurisma de la aorta
Pinze per aneurisma aorta



DE BAKEY
61017-26 - 61017-33

Atrauma

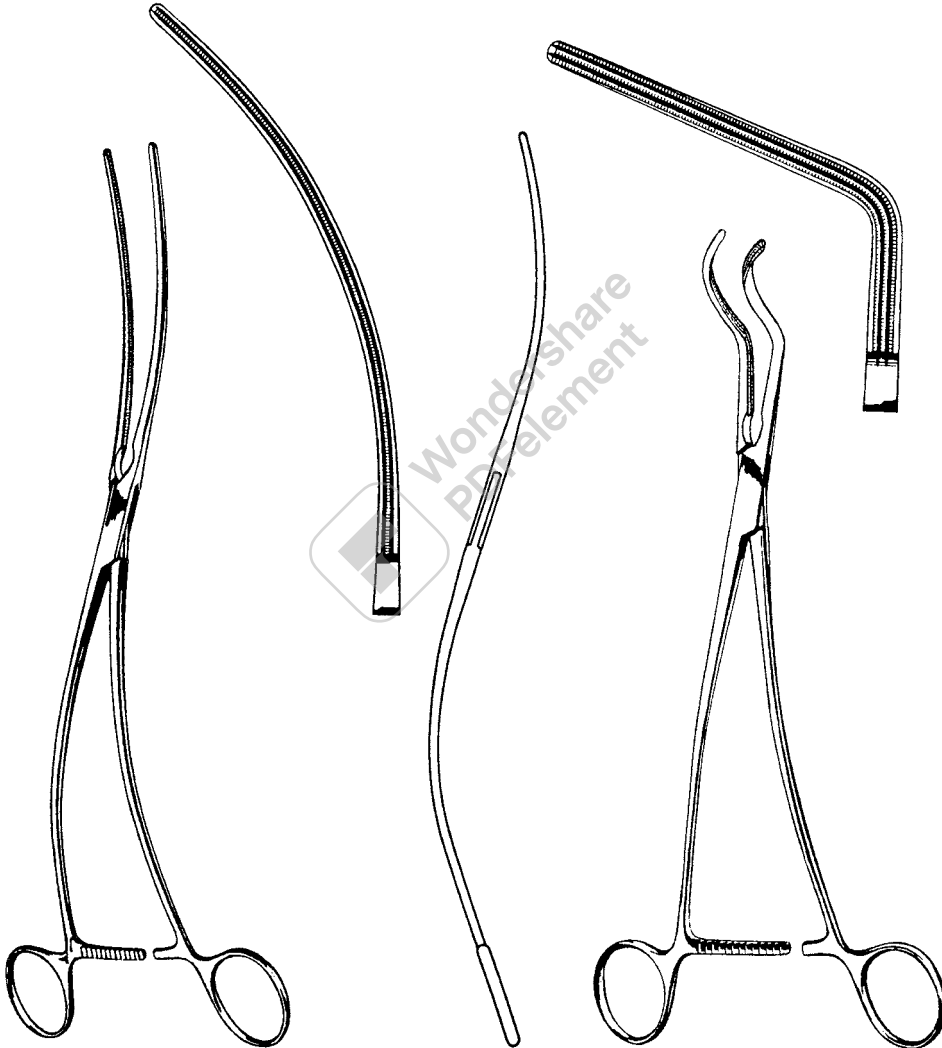
Aorta-Aneurysmaklemmen
Aortic aneurysm clamps
Pinzas-clamps para aneurisma de la aorta
Pinze per aneurisma aorta



DE BAKLEY
61018-28
28 cm, 11"

Atrauma

Aorta-Aneurysmaklemmen
Aortic aneurysm clamps
Pinzas-clamps para aneurisma de la aorta
Pinze per aneurisma aorta

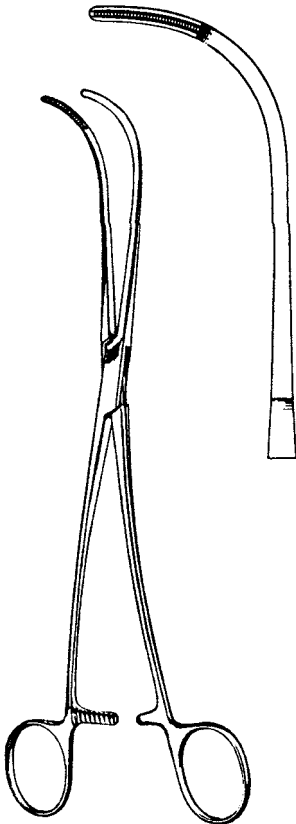


DE BAKEY
61019-30
30 cm, 11 ³/₄"

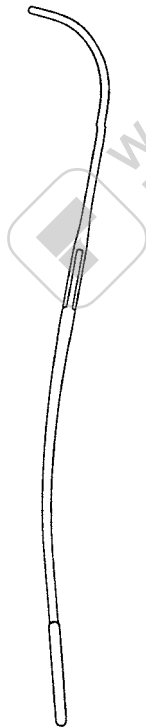
DE BAKEY
61020-27
27 cm, 10 ¹/₂"

Atrauma

Präparier- und Ligaturklemme
 Dissecting- and Ligature clamp
 Pinzas clamps para disección, ligaduras
 Pinze per dissezione, legature



DE BAKEY
 61021-24
 24 cm, 9 1/2"



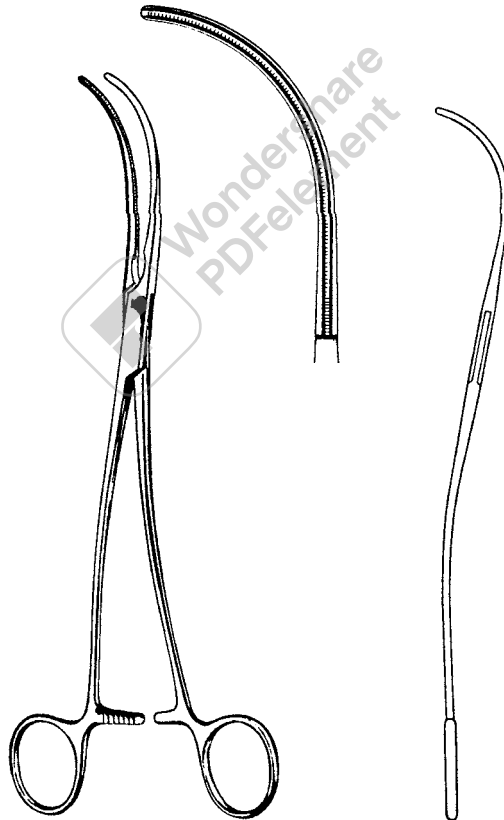
61022-01
 25 cm, 10"

61022-02
 24,5 cm, 9 3/4"

DE BAKEY-RUMEL

Atrauma

Ligaturklemmen
Ligature clamps
Pinzas clamps para ligaduras
Pinze per legature



DE BAKEY
61022-24
24 cm, 9 1/2"

Atrauma

Präparier- und Ligaturklemmen
Dissecting- and Ligature clamps
Pinza para disección y ligatura
Pinze per dissezione e legature



DE BAKEY-MIXTER
61022-28
28,5 cm, 11 1/4"

Atrauma

Ligaturklemme
Ligature clamp
Pinzas clamps para ligaduras
Pinze per legature

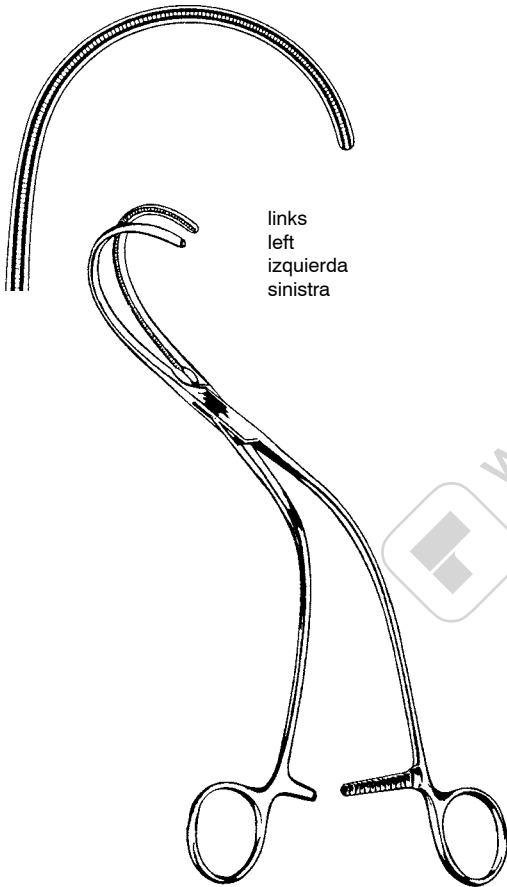


DE BAKEY
61023-25
25 cm, 10"

DE BAKEY
61023-26
26 cm, 10 1/4"

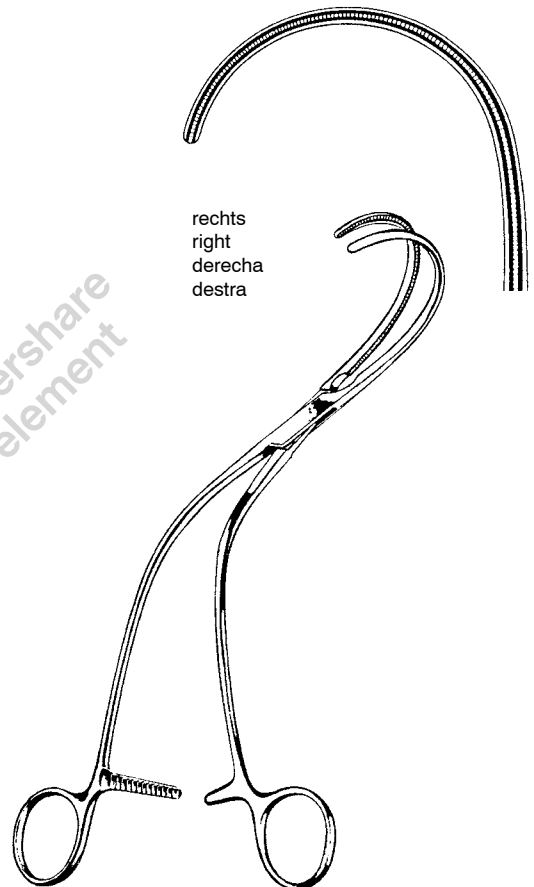
Atrauma

Aortaklemmen
Aortic clamps
Pinzas-clamps para la aorta
Pinze per aorta



links
left
izquierda
sinistra

WEBER
61024-01
26 cm, 10 1/4"

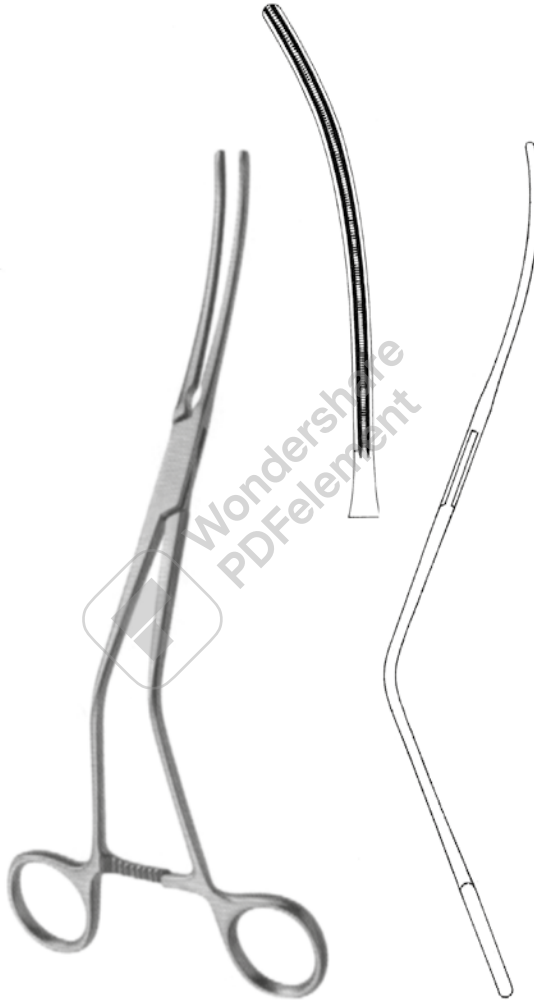


rechts
right
derecha
destra

WEBER
61024-02
26 cm, 10 1/4"

Atrauma

Aortaklemmen
Aortic clamps
Pinzas-clamps para la aorta
Pinze per aorta



WYLIE
61024-24
24 cm, 9 1/2"

Atrauma

Aortaklemmen
Aortic clamps
Pinzas-clamps para la aorta
Pinze per aorta



WYLIE
61024-27
27 cm, 10 1/2"

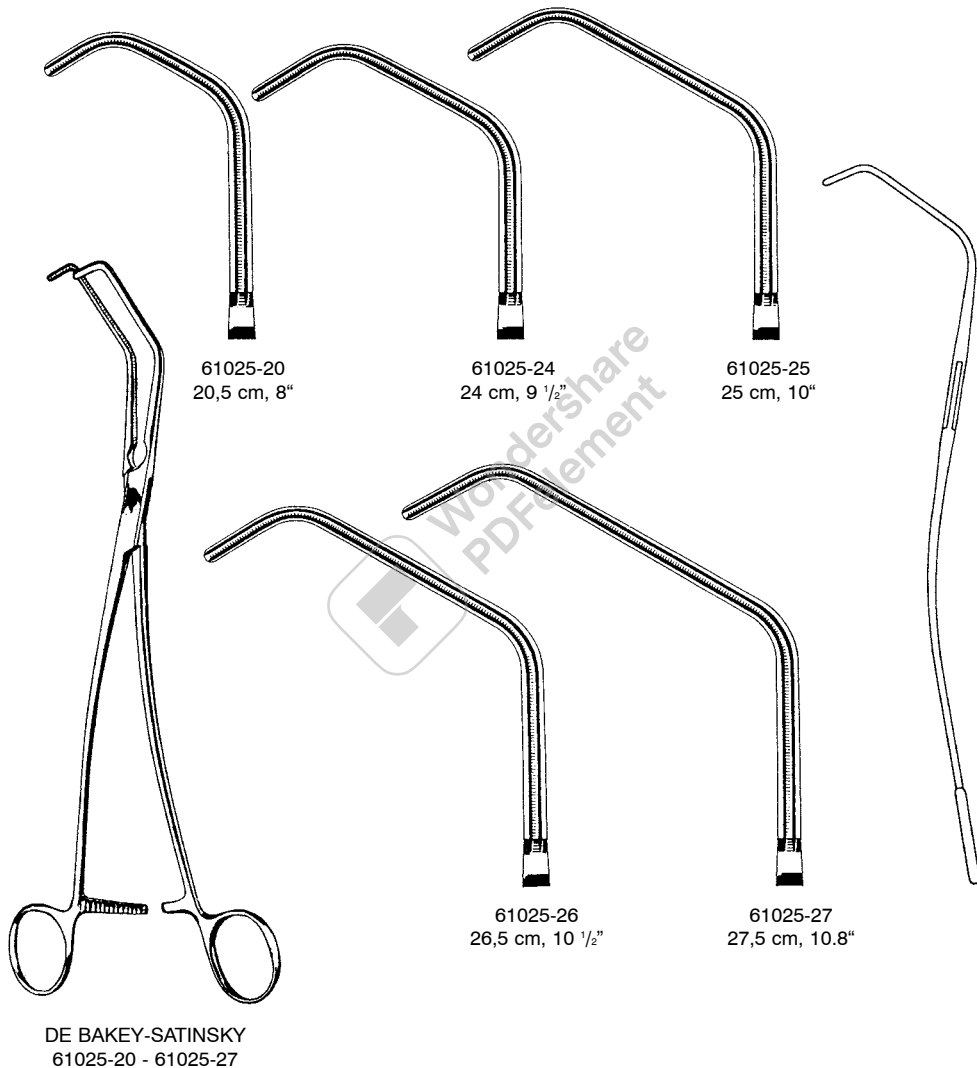
Atrauma

Tangentialklemmen

Tangential occlusion clamps

Pinzas-clamps para oclusión tangencial

Pinze per occlusione tangenziale

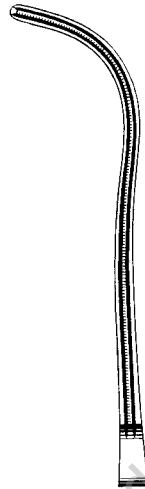


Atrauma

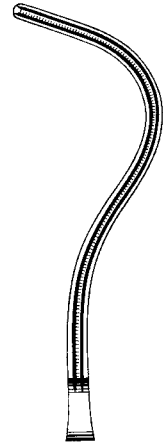
Aurikelklemmen
 Auricle clamps
 Pinza-clamps auriculares
 Pinza auricula



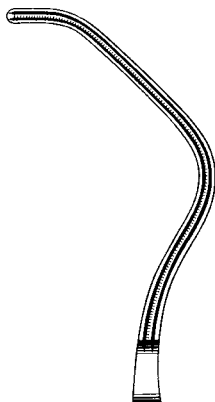
HARKEN
 61026-01 - 61026-04



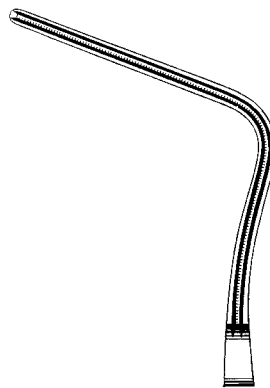
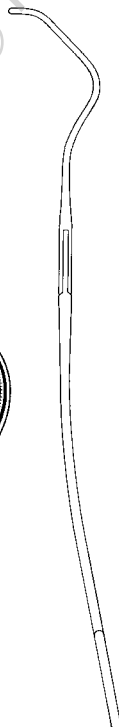
61026-01
 24 cm, 9 1/2"



61026-02
 24 cm, 9 1/2"



61026-03
 24 cm, 9 1/2"

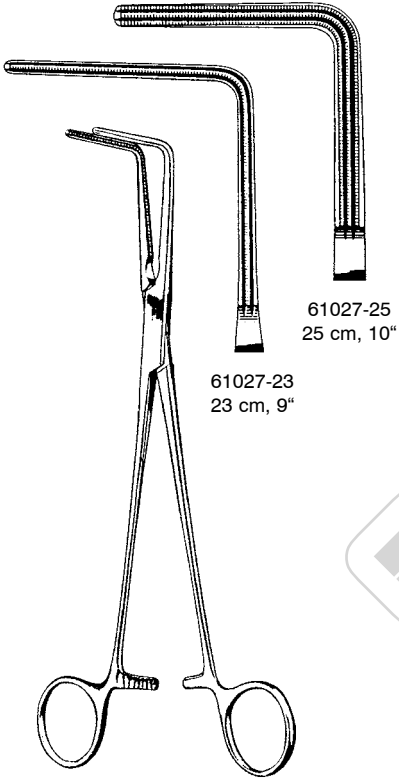


61026-04
 24 cm, 9 1/2"

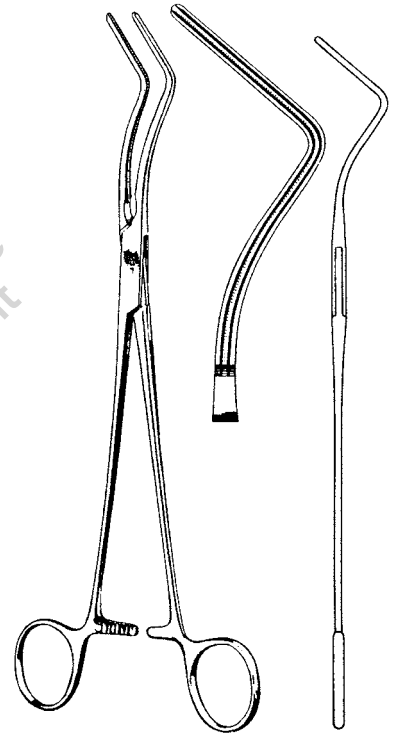


Atrauma

Bronchusklemmen
Bronchus clamp
Pinzas-clamps bronquiales
Pinze per bronchi



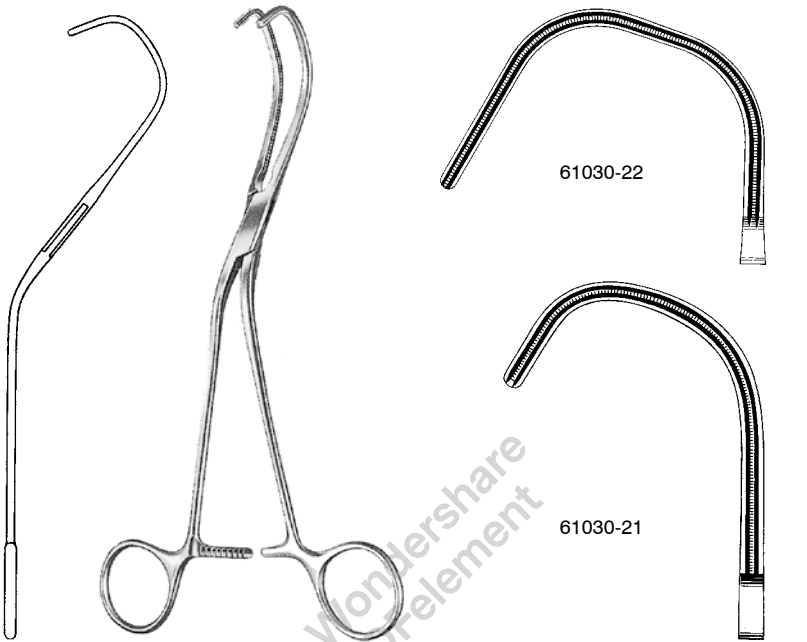
LEES
61027-23 - 61027-25



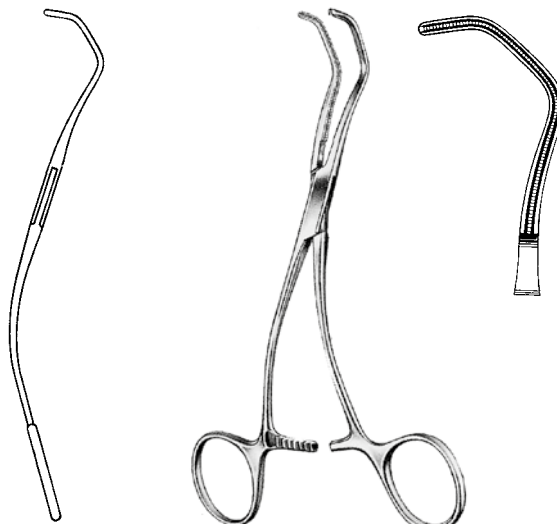
LEES
61029-25
25 cm, 10"

Wondershare PDFelement

Atrauma

Aorta-Anastomosenklemmen
Aortic anastomosis Clamps
Pinzas-clamps para anastomosis
Pinze anastomosi aorta

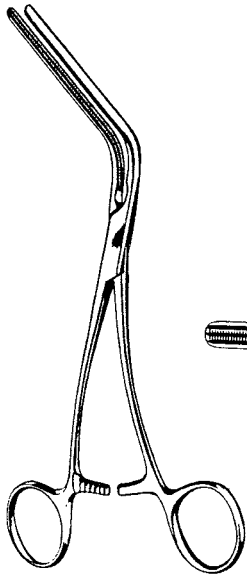
LAMBERT-KAY
21 cm, 8 1/4"
61030-21 - 61030-22



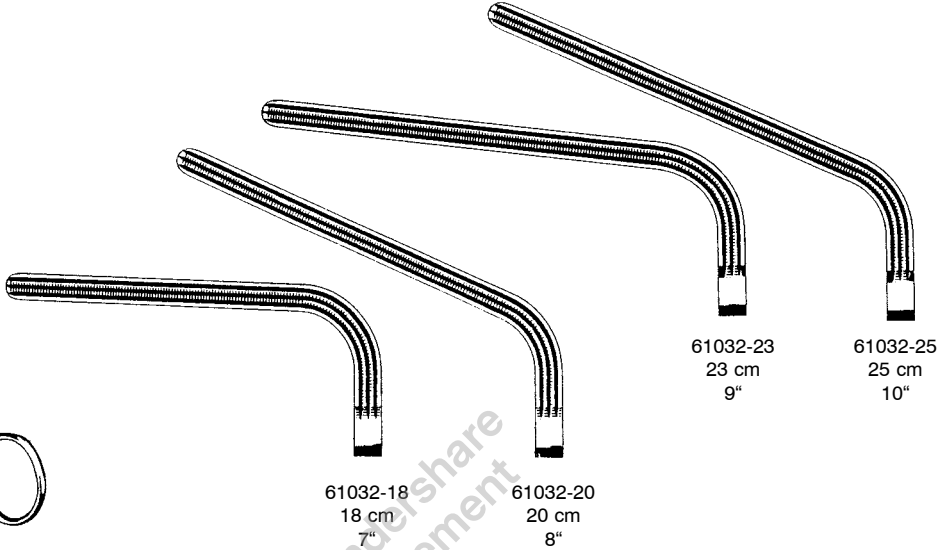
DE BAKEY
61031-17
17 cm, 6 3/4"

Atrauma

Aorta- und Aneurysmaklemme
Aortic- and Aneurysm Clamps
Pinzas aórticas y para aneurisma
Pinze per aorta e per aneurisma



MORRIS-DE BAKEY
61032-18 - 61032-25

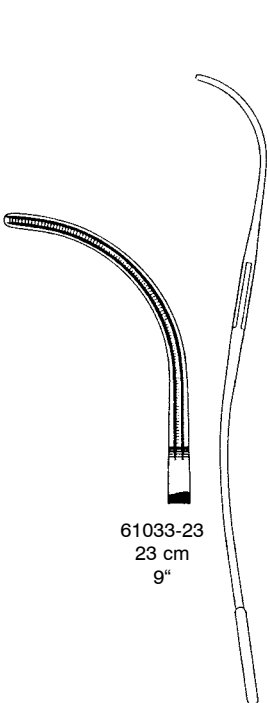


61032-18
18 cm
7"

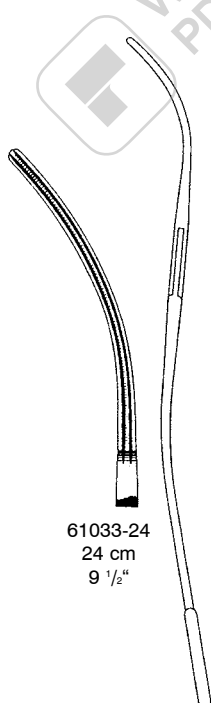
61032-20
20 cm
8"

61032-23
23 cm
9"

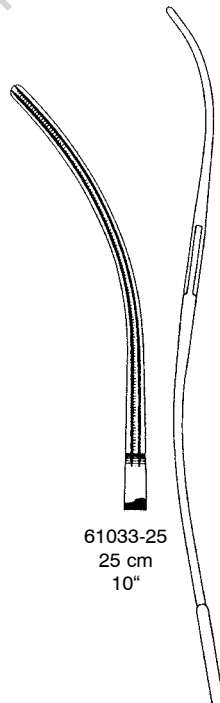
61032-25
25 cm
10"



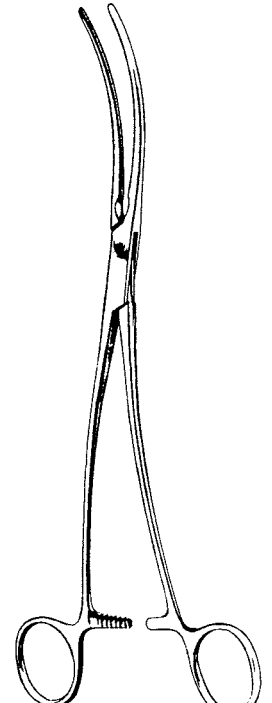
61033-23
23 cm
9"



61033-24
24 cm
9 1/2"



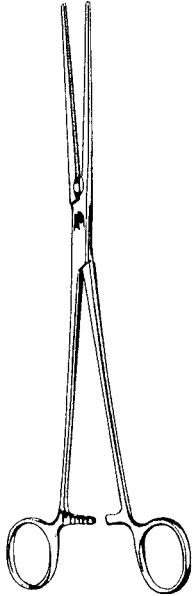
61033-25
25 cm
10"



DE BAKEY-BAHNSON
61033-23 - 61033-25

Atrauma

Mehrzweck-Gefäßklemme
Multi purpose Vascular Clamps
Pinzas vasculares de usos multiples
Pinze vascolari universali



DE BAKEY
61034-21 - 61034-31



61034-21
21,5 cm
8 1/2"



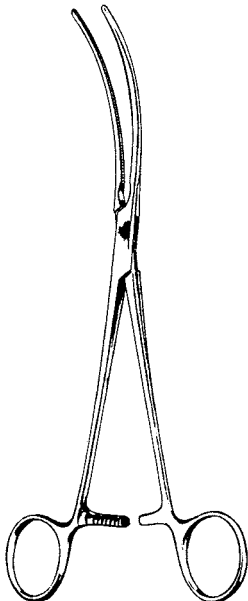
61034-23
23 cm
9"



61034-27
27 cm
10 1/2"



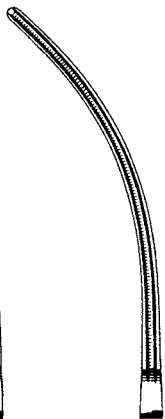
61034-31
31,5 cm
12 1/2"



DE BAKEY
61035-21 - 61035-31



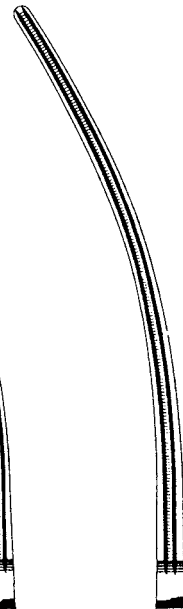
61035-21
21,5 cm
8 1/2"



61035-23
23 cm
9"



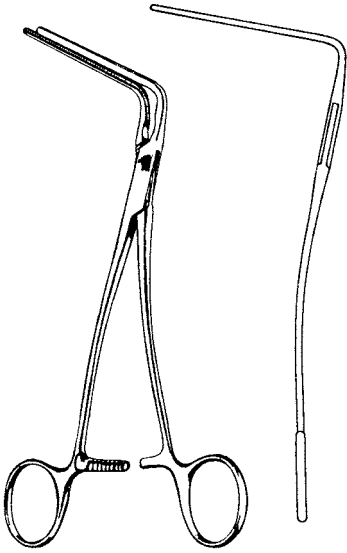
61035-27
27 cm
10 1/2"



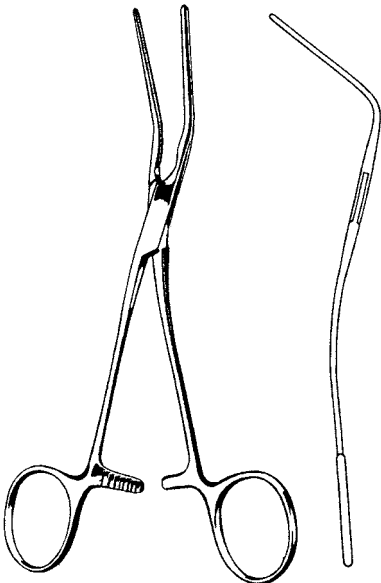
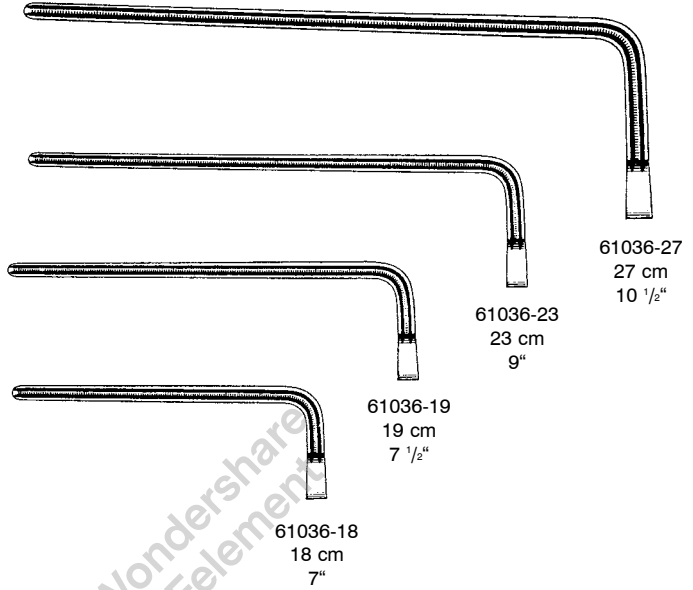
61035-31
31 cm
12 1/4"

Atrauma

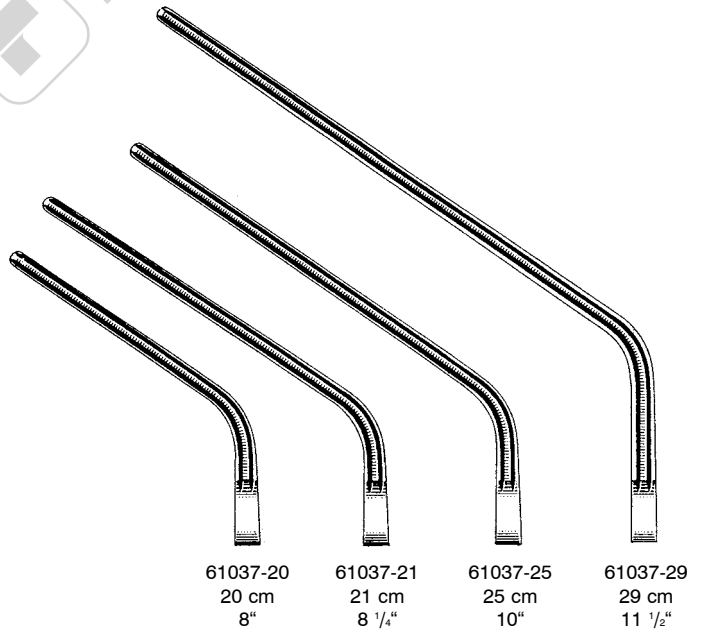
Mehrzweck-Gefäßklemme
Multi purpose Vascular Clamps
Pinzas vasculares de usos multiples
Pinze vascolari universali



DE BAKEY
61036-18 - 61036-27

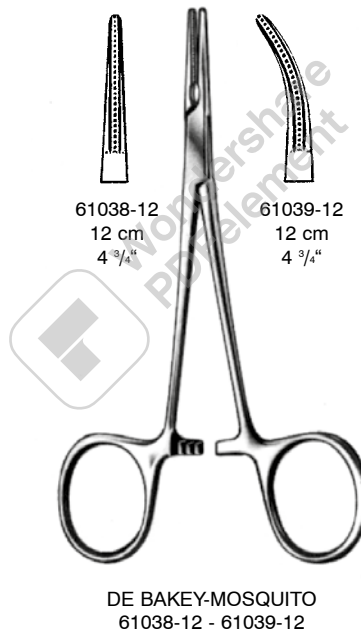


DE BAKEY
61037-20 - 61037-29



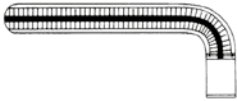
Atrauma

Arterienklemmen
Hemostatic forceps
Pinzas hemostáticas
Pinze emostatiche

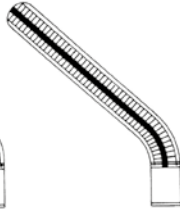


Atrauma

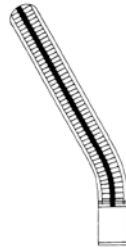
Mehrzweck-Gefäßklemme
Multi purpose Vascular Clamps
Pinzas vasculares de usos multiples
Pinze vascolari universali



61039-90
15 cm
5 1/2"
90°



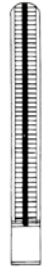
61039-45
15 cm
5 1/2"
45°



61039-30
15 cm
5 1/2"
30°



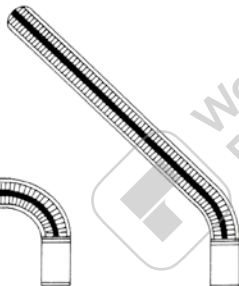
61039-15
15 cm
5 1/2"
15°



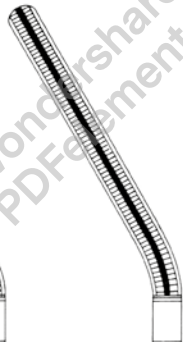
61039-00
15 cm
5 1/2"



61041-90
17 cm
6 1/2"
90°



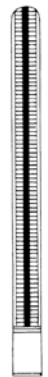
61041-45
17 cm
6 1/2"
45°



61041-30
17 cm
6 1/2"
30°



61041-15
15 cm
6 1/2"
15°



61041-00
17 cm
6 1/2"

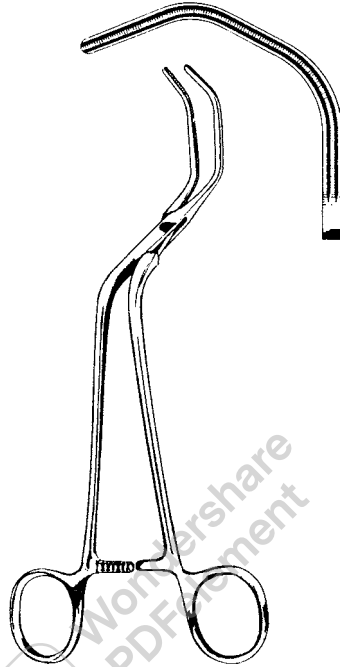


DARDIK

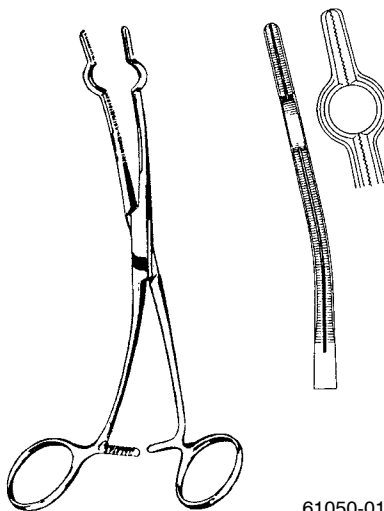


Atrauma

Aortaklemme, Katheterklemme
Aortic Clamps, Catheter Clamps
Pinzas-clamps para aorta, Pinzas para catéteres
Pinze per aorta, Pinze per cateteri



DIETRICH
61040-21 21 cm, 8 1/4"



COOLEY
61050-01 - 61050-07

Charrière (French)	Länge Length Largo Lungo cm		
24	16	6 1/4"	61050-01
26	16	6 1/4"	61050-02
28	20	8"	61050-03
30	20	8"	61050-04
32	20	8"	61050-05
36	20	8"	61050-07

61050-01 - 61050-02
für Kinder
for children
para niños
per bambini

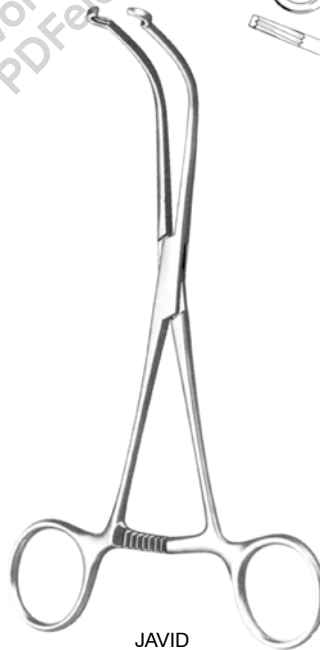
61050-03 - 61050-07
für Erwachsene
for adults
para adultos
per adulti

Atrauma

Carotis-Shuntklemmen
Carotid Shunt Clamps
Pinzas para shunt carótido
Pinze per carotide



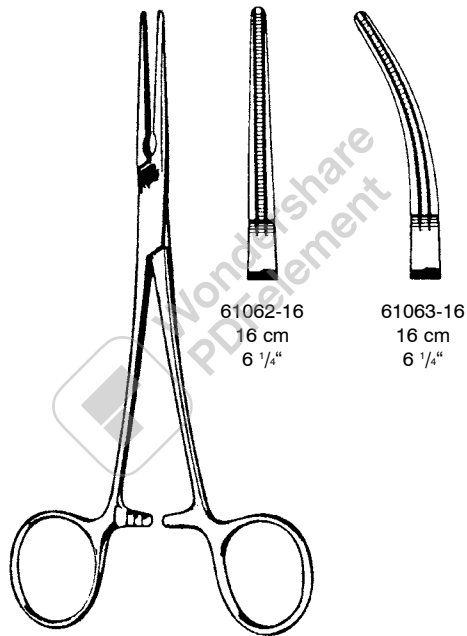
JAVID
61045-18
17,5 cm, 6.9"



JAVID
61046-19
18 cm, 7"

Atrauma

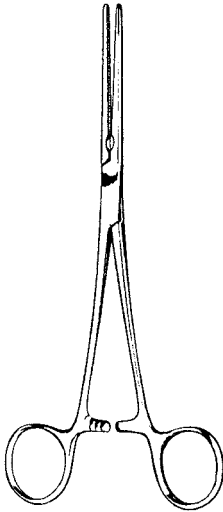
Arterienklemmen
Haemostatic Forceps
Pinzas hemostáticas
Pinze emostatiche



DE BAKEY-RANKIN
61062-16 - 61063-16

Atrauma

Arterienklemmen
Haemostatic Forceps
Pinzas hemostáticas
Pinze emostatiche



DE BAKEY-PEAN
61138-14 - 61138-20



61138-14
14 cm
5 1/2"



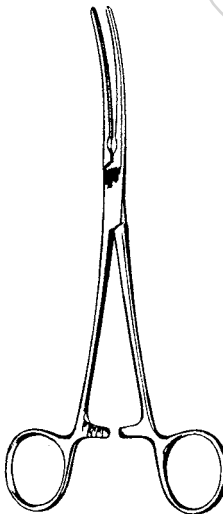
61138-16
16 cm
6 1/4"



61138-18
18 cm
7"



61138-20
20 cm
8"



DE BAKEY-PEAN
61139-14 - 61139-20



61139-14
14 cm
5 1/2"



61139-16
16 cm
6 1/4"



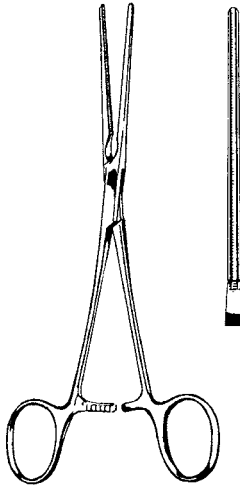
61139-18
18 cm
7"



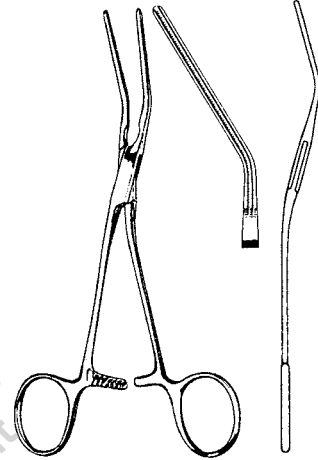
61139-20
20 cm
8"

Atrauma

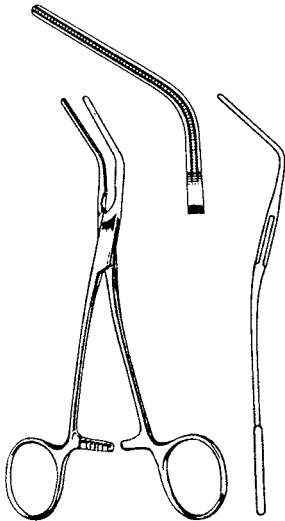
Mehrzweck-Gefäßklemmen
Multi purpose Vascular Clamps
Pinzas vasculares de usos múltiples
Pinze vascolari universali



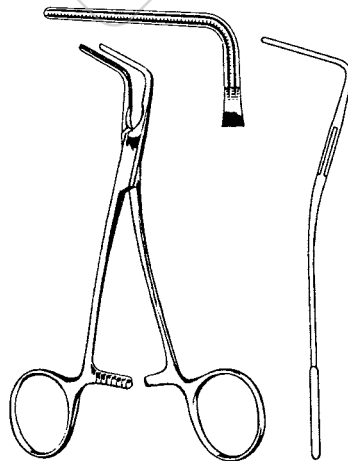
DE BAKAY
61140-17
17 cm, 6 3/4"



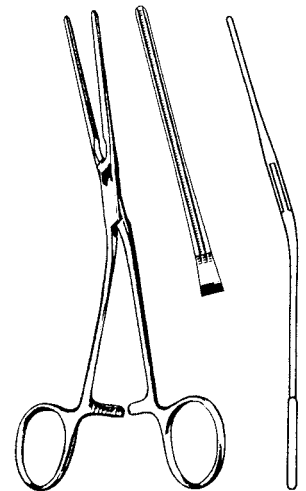
DE BAKAY
61141-16
16 cm, 6 1/4"



DE BAKAY
61143-15
15 cm, 6"



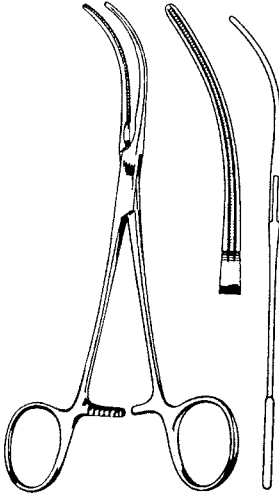
DE BAKAY
61145-15
15 cm, 6"



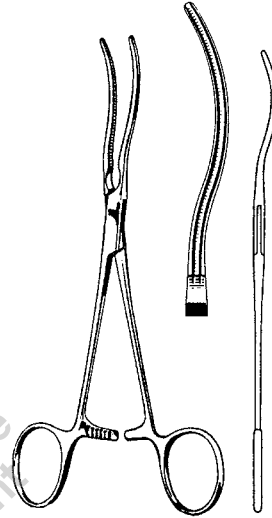
DE BAKAY
61147-17
17 cm, 6 3/4"

Atrauma

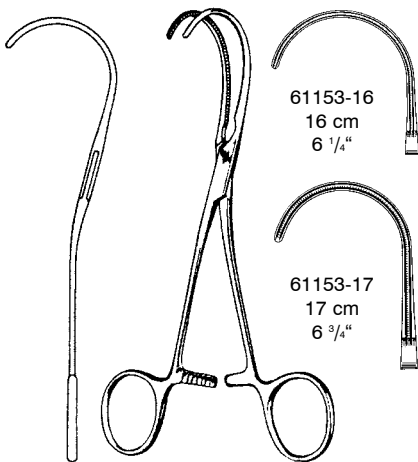
Mehrzweck-Gefäßklemmen, Anastomosenklemmen
 Multi purpose Vascular Clamps, Anastomosis Clamps
 Pinzas vasculares de usos múltiples, Pinzas para anastomosis
 Pinze vascolari universali, Pinze per anastomosi



GLOVER
 61149-17
 17 cm, 6 3/4"



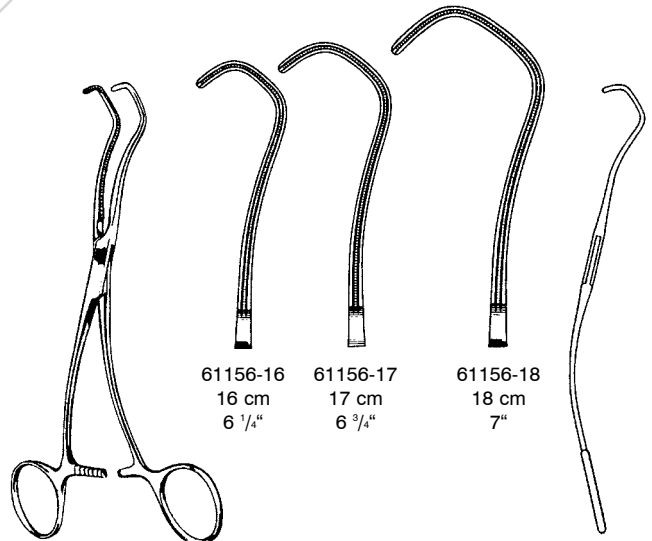
GLOVER
 61151-17
 17 cm, 6 3/4"



DE BAKEY
 61153-16 - 61153-17

61153-16
 16 cm
 6 1/4"

61153-17
 17 cm
 6 3/4"



DERRA
 61156-16 - 61156-18

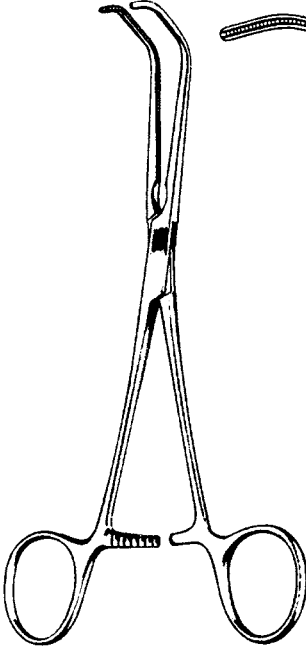
61156-16
 16 cm
 6 1/4"

61156-17
 17 cm
 6 3/4"

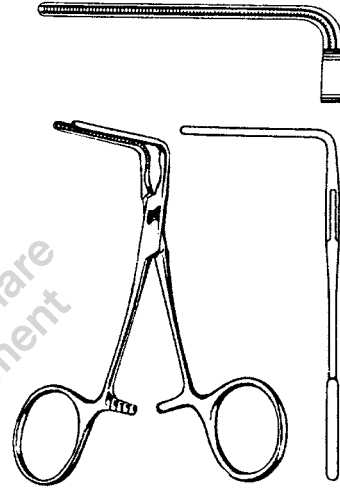
61156-18
 18 cm
 7"

Atrauma

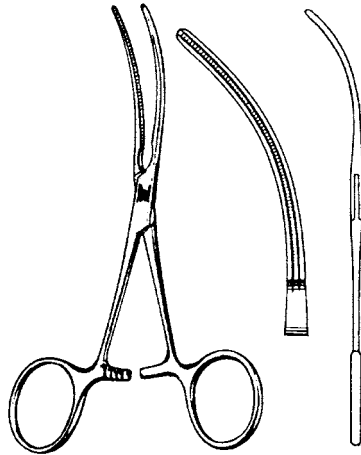
Anastomosenklemmen, Kinder-Gefäßklemmen
 Anastomosis Clamps, Pediatric Vascular Clamps
 Pinzas para anastomosis, Pinzas vasculares pediátricas
 Pinze per anastomosi, Pinze vascolari pediatriche



DE BAKEY-BECK
 61157-17 17 cm, 6 ³/₄"



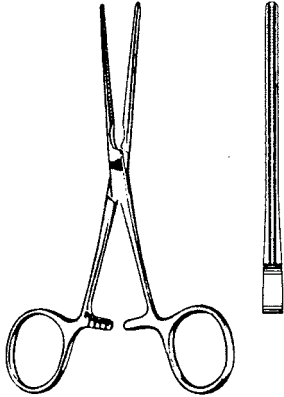
DE BAKEY
 61158-10 10 cm, 4"



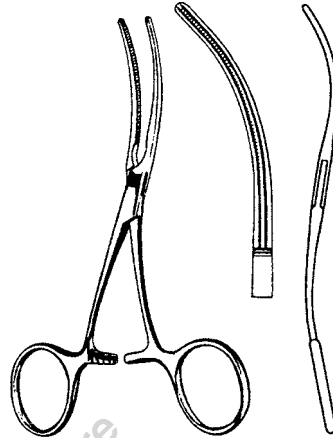
DE BAKEY
 61158-11 11 cm, 4 ³/₈"

Atrauma

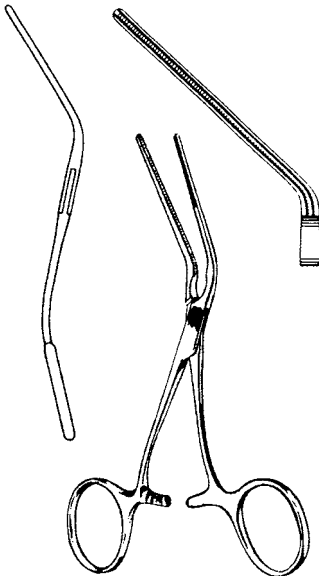
Kinder-Gefäßklemmen, Profundaklemmen
 Pediatric Vascular Clamps, Profunda Clamps
 Pinzas vasculares pediátricas, Pinzas para la profunda
 Pinze vascolari pediatriche, Pinze profunda



DE BAKEY
 61158-12 12 cm, 4 ³/₄"



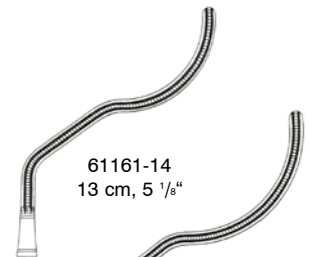
DE BAKEY
 61159-12 11,5 cm, 4 ¹/₂"



DE BAKEY
 61159-13 13 cm, 5 ¹/₈"



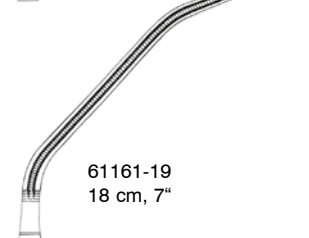
GREGORY



61161-14
 13 cm, 5 ¹/₈"



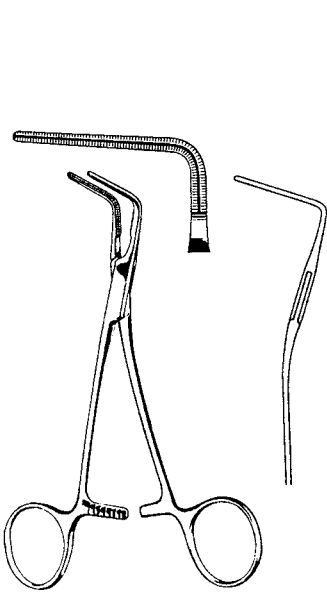
61161-18
 16 cm, 6 ¹/₄"



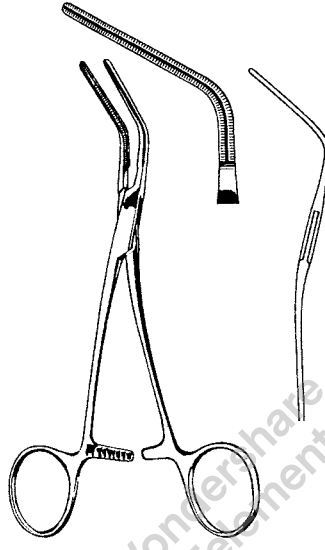
61161-19
 18 cm, 7"

Atrauma

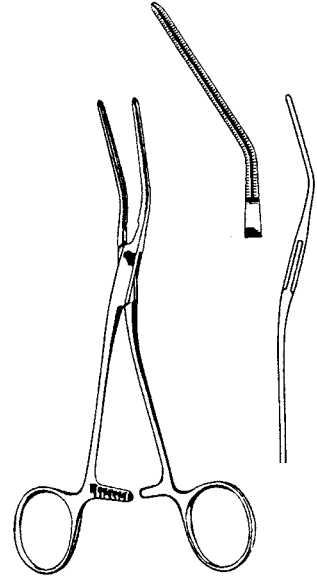
Mehrzweck-Gefäßklemmen
Multi purpose Vascular Clamps
Pinzas vasculares de usos múltiples
Pinze vascolari universali



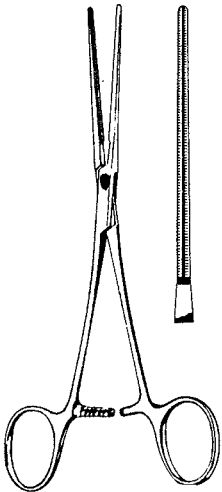
COOLEY
61172-15
15 cm, 6"



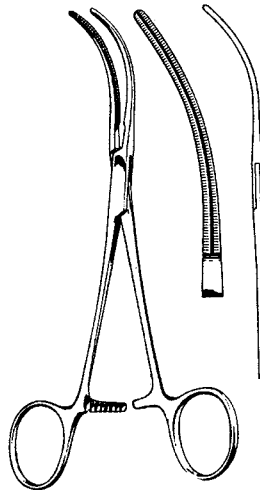
COOLEY
61173-16
15,5 cm, 6"



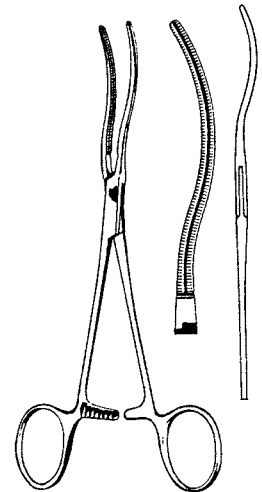
COOLEY
61174-17
17 cm, 6 3/4"



COOLEY
61175-17
17 cm, 6 3/4"



COOLEY
61176-17
17 cm, 6 3/4"



COOLEY
61177-17
17 cm, 6 3/4"

Atrauma

Anastomosenklemmen
Anastomosis Clamps
Pinzas para anastomosis
Pinze per anastomosi



COOLEY-DERRA
61178-16 - 61179-18



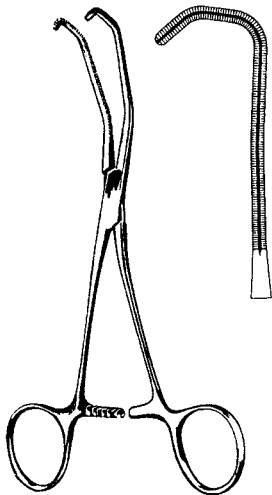
61178-16
16 cm
6 1/4"



61178-17
17 cm
6 3/4"



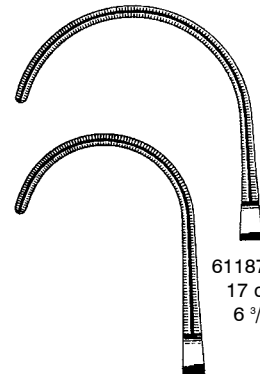
61179-18
18 cm
7"



COOLEY
61180-17
17 cm, 6 3/4"

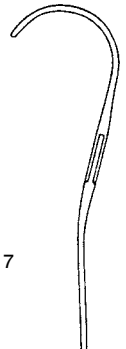


COOLEY
61187-16 - 61187-17



61187-17
17 cm
6 3/4"

61187-16
16 cm
6 1/4"



Atrauma

Anastomosenklemmen, Mehrzweck-Gefäßklemme

Anastomosis Clamp, Multi purpose Vascular Clamps

Pinza clamp para iliac y anastomosis, Pinzas vasculares de usos multiples

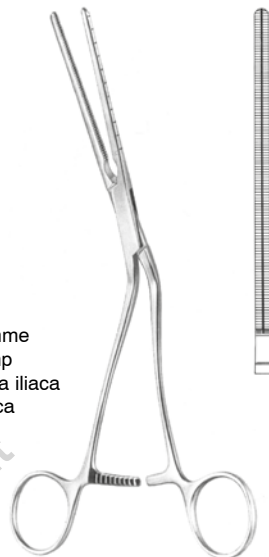
Pinze anastomosi, Pinze vascolari universali

Carotisklemme
Carotid Clamp
Pinza para carótida
Pinza per carotis



COOLEY
61188-20 20 cm, 8"

Iliacaklemme
Iliac Clamp
Pinza para iliaca
Pinza iliaca



COOLEY
61189-21 21 cm, 8 1/4"



BECK
61190-17 17 cm, 6 3/4"

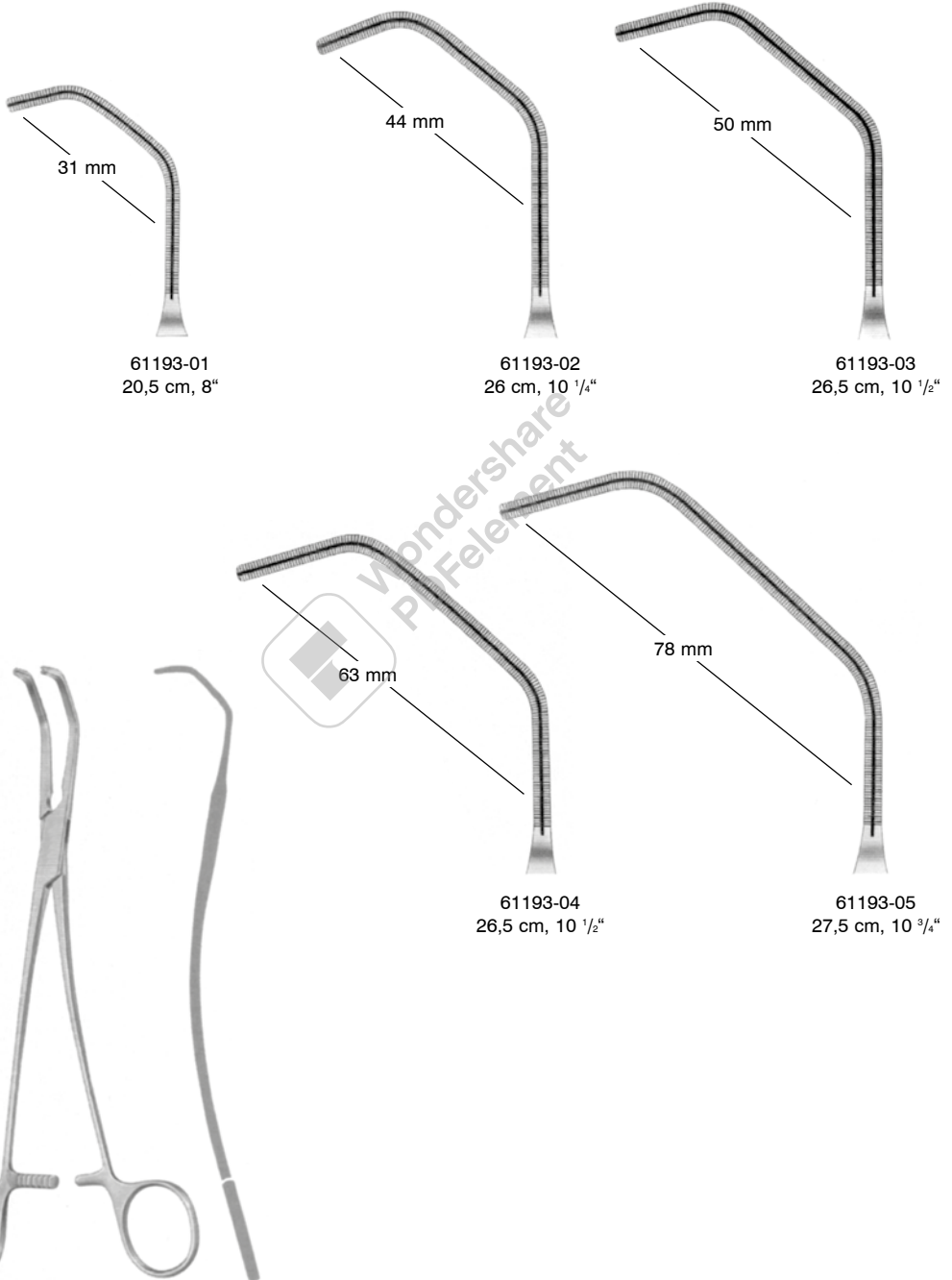


COOLEY
61191-16 16 cm, 6 1/4"



COOLEY
61192-17 17 cm, 6 3/4"

Atrauma

Anastomosenklemmen
Anastomosis Clamp
Pinza clamp para iliac y anastomosis
Pinze anastomosi

COOLEY

Atrauma

Mehrzweck-Gefäßklemme
Multi purpose Vascular Clamps
Pinzas vasculares de usos multiples
Pinze vascolari universali

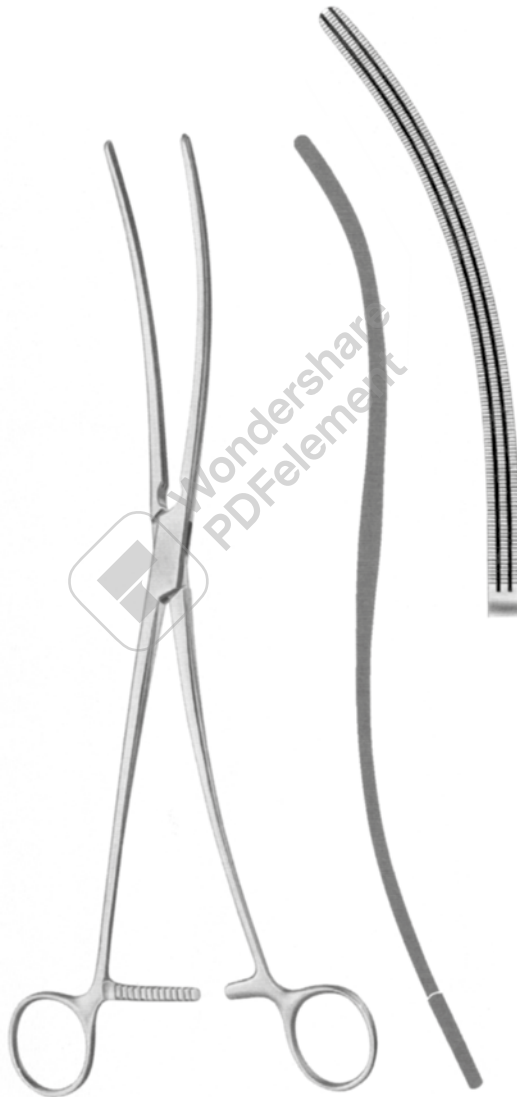


COOLEY
61194-26 26 cm, 10 ³/₄"

COOLEY
61195-28 28,5 cm, 11 ¹/₄"

Atrauma

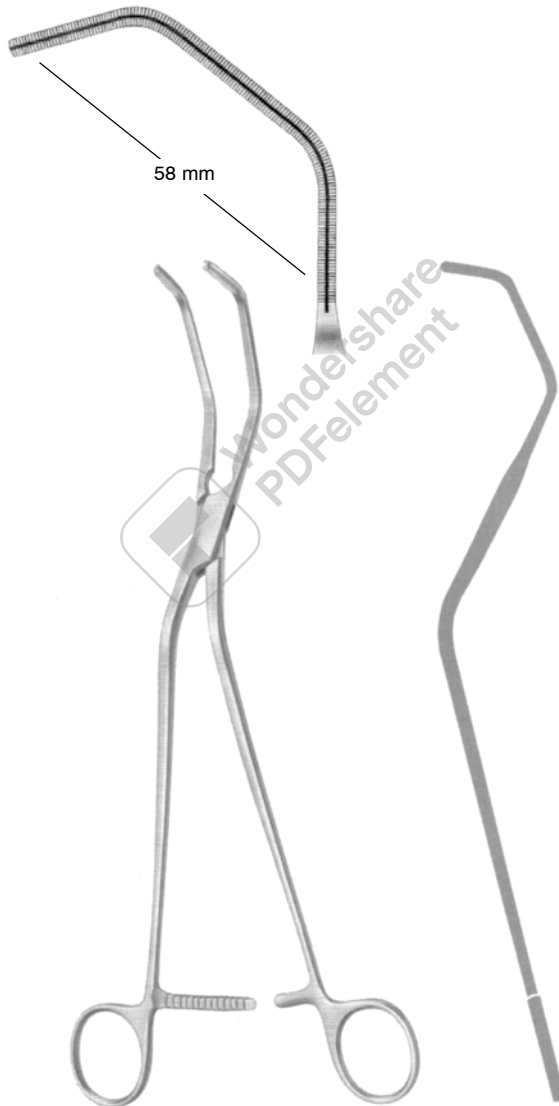
Aortaklemme
Aortic Clamps
Pinzas aórticas
Pinze per aorta



COOLEY
61195-32 32 cm, 12 3/4"

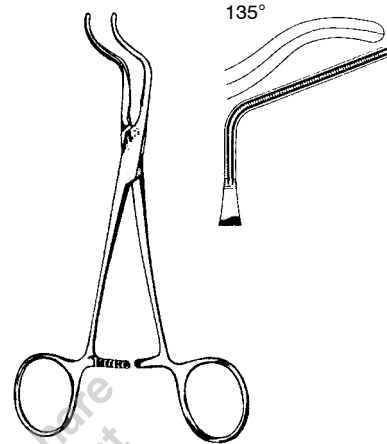
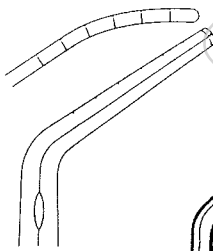
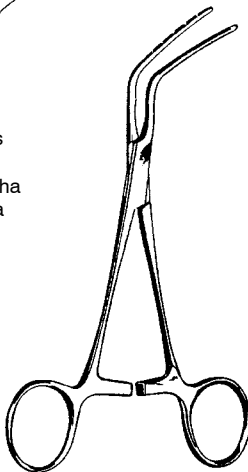
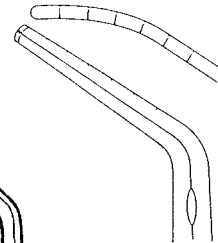
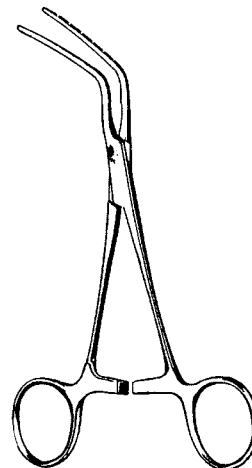
Atrauma

Anastomosenklemmen
Anastomosis Clamp
Pinza clamp para iliac y anastomosis
Pinze anastomosi



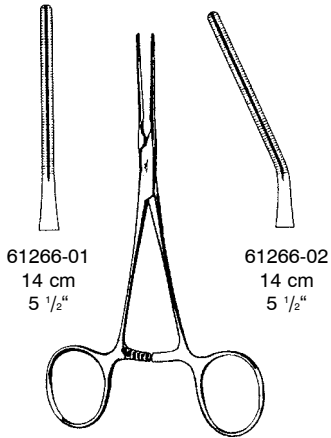
COOLEY
61196-26 26 cm, 10 1/4"

Atrauma

Kinder-Aortaklemme
Pediatric Aortic Clamps
Pinza aórticas pediátricas
Pinze per aorta pediatricheSUBRAMANIAN-MINIATURE
61259-15 15,5 cm, 6"rechts
right
derecha
destraSUBRAMANIAN
61261-16 16 cm, 6 1/4"links
left
izquierda
sinistraSUBRAMANIAN
61263-16 16 cm, 6 1/4"

Atrauma

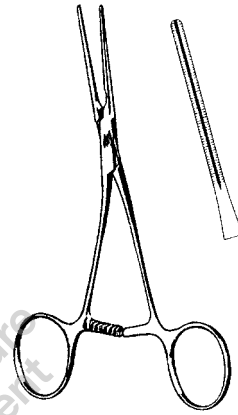
Kinder-Gefäßklemmen
 Pediatric Vascular Clamps
 Pinzas vasculares pediátricas
 Pinze vascolari pediatriche



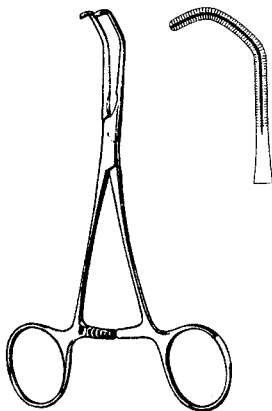
61266-01
 14 cm
 5 1/2"

61266-02
 14 cm
 5 1/2"

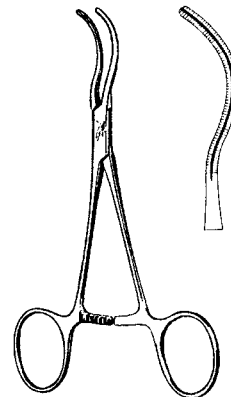
COOLEY
 61266-01 - 61266-02
 14 cm, 5 1/2"



COOLEY
 61266-03 14 cm, 5 1/2"



COOLEY
 61266-04 14 cm, 5 1/2"



COOLEY
 61266-05 14 cm, 5 1/2"

Atrauma

Kinder-Gefäßklemmen
 Pediatric Vascular Clamps
 Pinzas vasculares pediátricas
 Pinze vascolari pediatriche

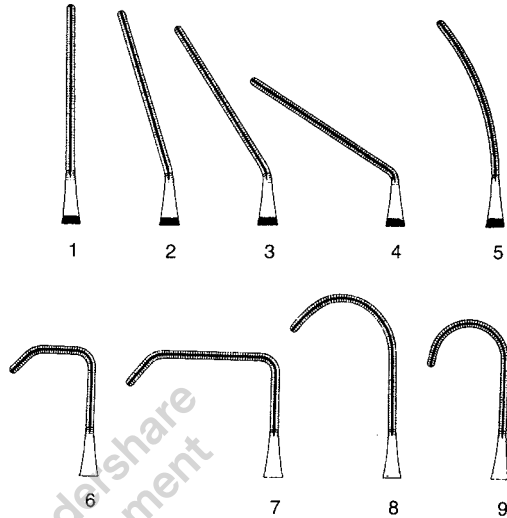
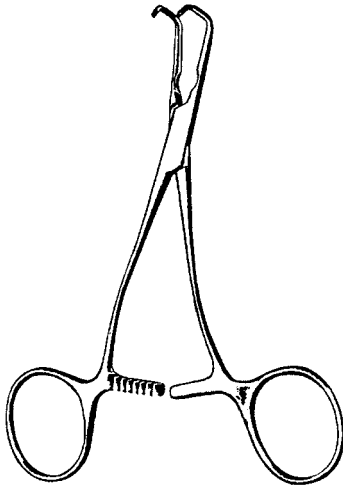


Fig.	gerade straight rectas rette	
1	61372-01 14 cm, 5 1/2"	
2	61372-02 14 cm, 5 1/2"	
3	61372-03 14 cm, 5 1/2"	
4	61372-04 13 cm, 5 1/8"	
5	61372-05 14 cm, 5 1/2"	
6	61372-06 13 cm, 5 1/8"	
7	61372-07 13 cm, 5 1/8"	
8	61372-08 14 cm, 5 1/2"	
9	61372-09 13,5 cm, 5 1/4"	

Fig.	stark abgewinkelt strongly angled ramas anguladas forte angolata	
1	61373-01 14 cm, 5 1/2"	
2	61373-02 14 cm, 5 1/2"	
3	61373-03 14 cm, 5 1/2"	
4	61373-04 13 cm, 5 1/8"	
5	61373-05 14 cm, 5 1/2"	
6	61373-06 13 cm, 5 1/8"	
7	61373-07 13 cm, 5 1/8"	
8	61373-08 14 cm, 5 1/2"	
9	61373-09 13,5 cm, 5 1/4"	

Fig.	abgewinkelt angled acodadas angolate	
1	61374-01 14 cm, 5 1/2"	
2	61374-02 14 cm, 5 1/2"	
3	61374-03 14 cm, 5 1/2"	
4	61374-04 13 cm, 5 1/8"	
5	61374-05 14 cm, 5 1/2"	
6	61374-06 13 cm, 5 1/8"	
7	61374-07 13 cm, 5 1/8"	
8	61374-08 14 cm, 5 1/2"	
9	61374-09 13,5 cm, 5 1/4"	

Clipanlagezangen für die offene Chirurgie 25° aufgebogen
 Clip Appliers for open Surgery 25° upcurved
 Pinza aplicadora de clips para cirugía abierta con ángulo de 25°
 Pinza applicatore clips per chirurgia aperto, curvo in alto 25°



15 cm, 6"

Horizon

61460-15 Small gelb / yellow / jaune/ amarillo/ giallo
 61461-15 Medium blau / blue / bleu / azul / blu

SLS Clips

61464-15 Micro weiss / white / blanc / blanco / bianco
 61465-15 Small gelb / yellow / jaune/ amarillo/ giallo
 61466-15 Small medium lila / lilac / lilas / lila / lilla
 61467-15 Medium blau / blue / bleu / azul / blu

Ethicon

61470-15 Small blau / blue / bleu / azul / blu
 61471-15 Medium weiss / white / blanc / blanco / bianco

Pilling

61481-15 Small gelb / yellow / jaune / amarillo / giallo
 61482-15 Medium blau / blue / bleu / azul / blu

Horizon

61460-19 Small gelb / yellow / jaune / amarillo / giallo
 61461-19 Medium blau / blue / bleu / azul / blu
 61462-19 Medium Large grün / green / verde / verde
 61463-19 Large orange / naranja / arancione

SLS Clips

61464-19 Micro weiss / white / blanc / blanco / bianco
 61465-19 Small gelb / yellow/ jaune / amarillo / giallo
 61466-19 Small medium lila / lilac / lilas / lila / lilla
 61467-19 Medium blau / blue / bleu / azul / blu
 61468-19 Medium Large grün / green / verde / verde
 61469-19 Large orange / naranja / arancione

Ethicon

61470-19 Small blau / blue / bleu / azul / blu
 61471-19 Medium weiss / white / blanc / blanco / bianco
 61472-19 Medium Large grün / green / verde / verde
 61473-19 Large gelb / yellow / jaune / amarillo / giallo

Pilling

61481-19 Small gelb / yellow / jaune / amarillo / giallo
 61482-19 Medium blau / blue / bleu / azul / blu
 61484-19 Medium Large grün / green / verde / verde
 61483-19 Large orange / naranja / arancione



19 cm, 7 1/2"

Clipanlegezangen für die offene Chirurgie 25° aufgebogen
Clip Appliers for open Surgery 25° upcurved
Pinza aplicadora de clips para cirugía abierta con ángulo de 25°
Pinza applicatore clips per chirurgia aperto, curvo in alto 25°

Horizon

- 61461-28 Medium blau / blue / bleu / azul / blu
61462-28 Medium Large grün / green / verde / verde
61463-28 Large orange / naranja / arancione

SLS Clips

- 61464-28 Micro weiss / white / blanco / bianco
61465-28 Small gelb / yellow / jaune / amarillo / giallo
61466-28 Small medium lila / lilac / lilas / lila / lilla
61467-28 Medium blau / blue / bleu / azul / blu
61468-28 Medium Large grün / green / verde / verde
61469-28 Large orange / naranja / arancione

Ethicon

- 61471-28 Medium weiss / white / blanco / bianco
61472-28 Medium Large grün / green / verde / verde
61473-28 Large gelb / yellow / jaune / amarillo / giallo

Pilling

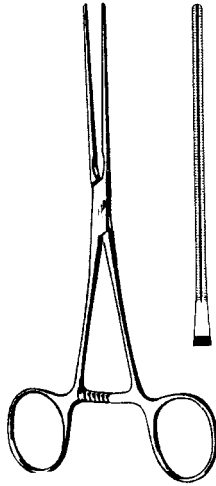
- 61482-28 Medium blau / blue / bleu / azul / blu
61484-28 Medium Large grün / green / verde / verde
61483-28 Large orange / naranja / arancione



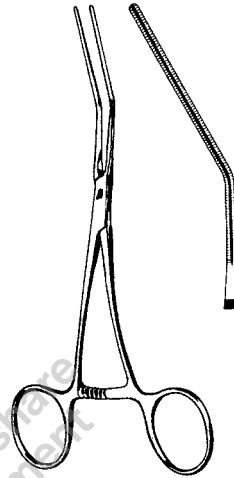
28 cm, 11"

Atrauma

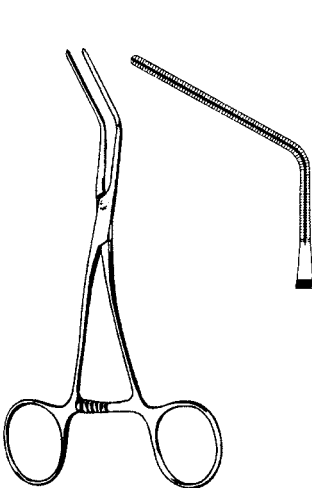
Kinder-Gefäßklemmen
 Pediatric Vascular Clamps
 Pinzas vasculares pediátricas
 Pinze vascolari pediatriche



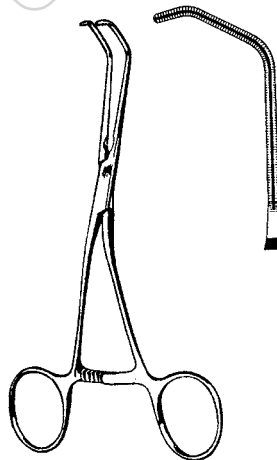
61488-16
 16,5 cm, 6 1/2"



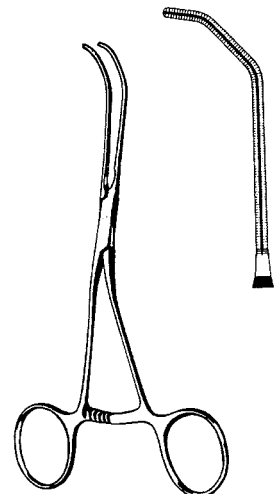
61489-16
 16 cm, 6 1/4"



61490-15
 15 cm, 6"



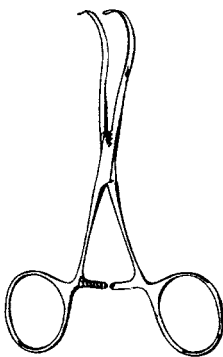
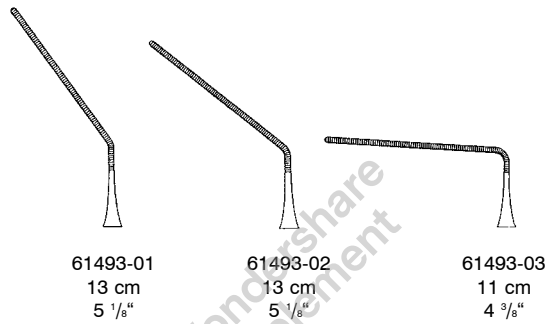
61491-15
 15 cm, 6"



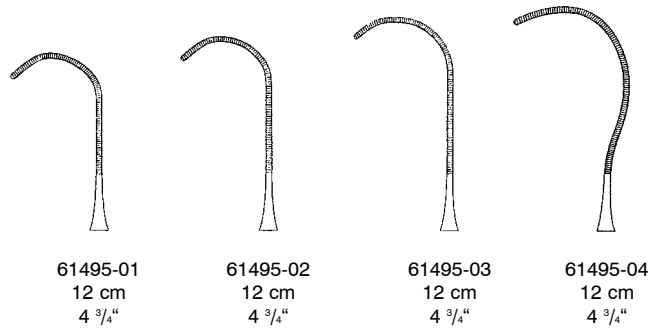
61492-16
 15,5 cm, 6"

Atrauma

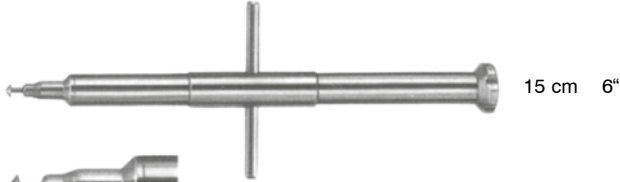
Neonatal-Gefäßklemmen
 Neonatal Vascular Clamps
 Pinzas vasculares para recién nacidos
 Pinze vascolari per neonati



CASTANEDA
 61493-01 - 61495-04



Aortenstanzen, Tourniquets
 Aorta punches, Tourniquets
 Trefina para aorta, Tourniquets
 Trefino per Aorta, Tornichetti



15 cm 6"



61715-04 Ø 4 mm



61715-05 Ø 5 mm



61715-06 Ø 6 mm

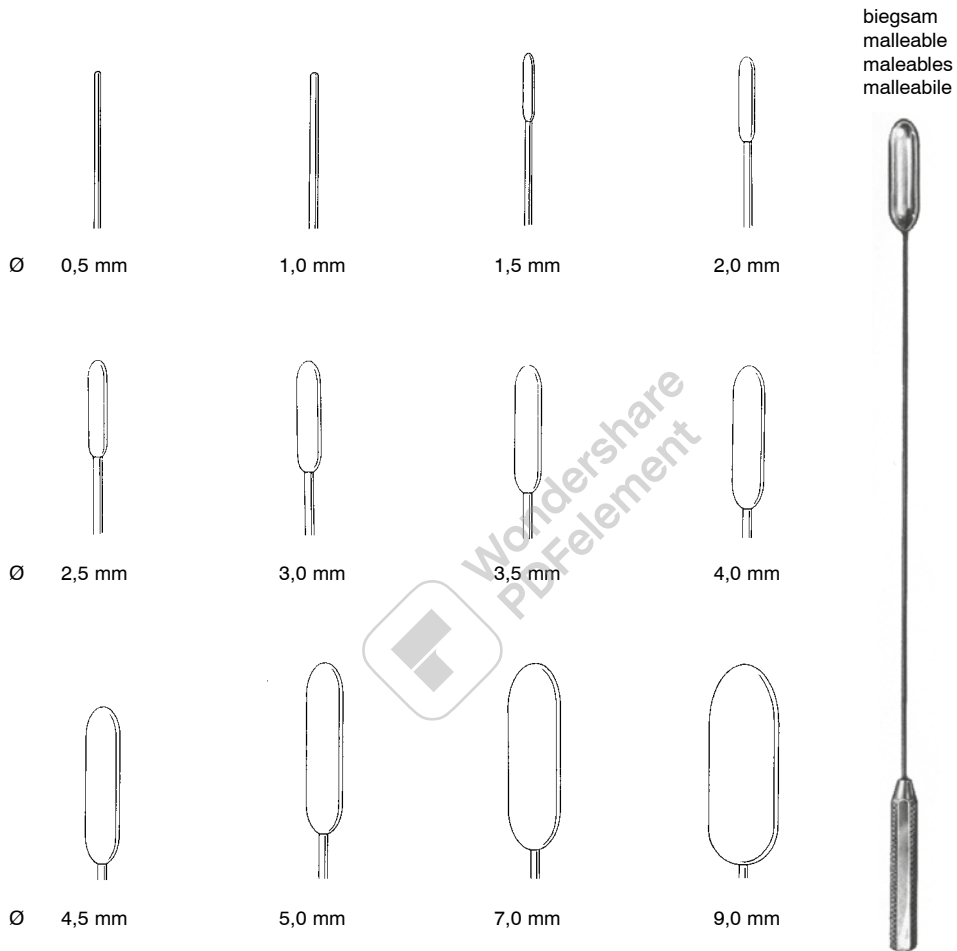


61700-01
 61710-01
 Mandrin alleine
 Guide only
 Guida sola



RUMEL-BELMONT
 61700-33 3,2 mm Ø
 61710-33 6,4 mm Ø
 33 cm, 13"
 flexibel, flexible,
 flexible, flessibile

Gefäß-Dilatatoren
Vascular Dilators
Dilatadores vasculares
Dilatatori vascolari



DE BAKEY

19 cm, 7 1/2"	Ø mm	35 cm, 13 3/4"
61810-05	0,5	61820-05
61810-10	1,0	61820-10
61810-15	1,5	61820-15
61810-20	2,0	61820-20
61810-25	2,5	61820-25
61810-30	3,0	61820-30
61810-35	3,5	61820-35
61810-40	4,0	61820-40
61810-45	4,5	61820-45
61810-50	5,0	61820-50
61810-70	7,0	61820-70
61810-90	9,0	61820-90

Gefäßdissektoren
 Vascular Dissectors
 Disecadores vasculares
 Dissettori vascolari



ROBB
 24 cm, 9 1/2"

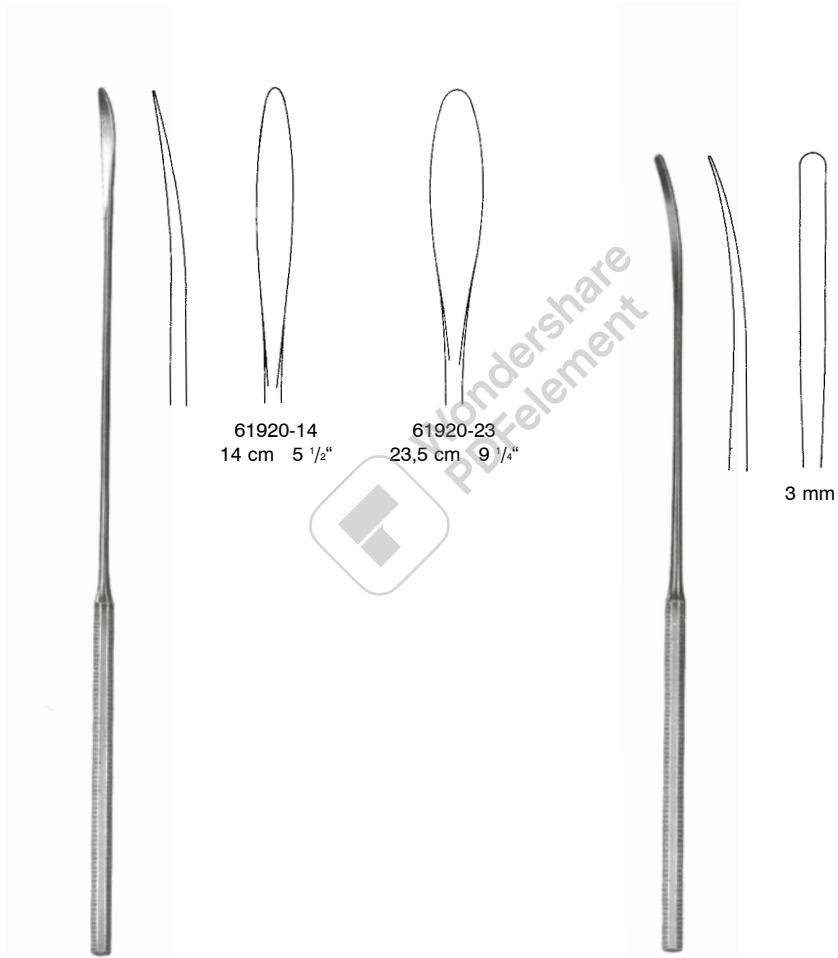
Fig. 1
 61910-01

Fig. 2
 61910-02

Fig. 3
 61910-03

Fig. 4
 61910-04

Intimaspatel
Intima Spatulas
Espátulas para la intima
Spatole per intima



stumpf
blunt
roma
smussa

61930-18
18,5 cm, 7 1/4"

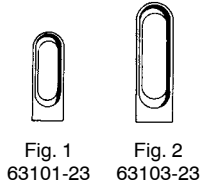
61930-21
21,5 cm, 8 1/2"

stumpf
blunt
roma
smussa

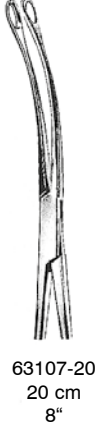
Gallensteinzangen
 Gall Stone Forceps
 Pinzas para cálculos biliares
 Pinze per calcoli biliari



DESJARDINS
 23 cm, 9"



BLAKE
 63106-20 20 cm, 8"



MAYO-BLAKE
 63110-20 20 cm, 8"

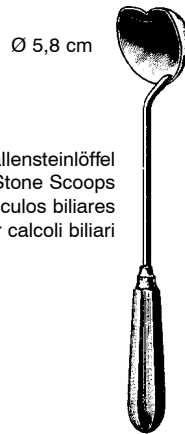


MAYO-BLAKE
 63111-20 20 cm, 8"



MIXTER
 63117-22 22 cm, 8 3/4"

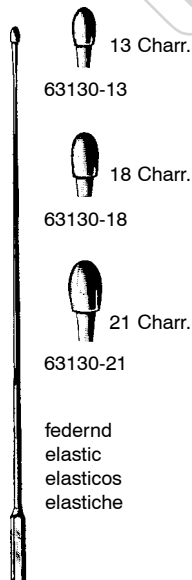
Gallensteinsonden, Gallengangdilatoren
 Gall Stone Probes, Bile duct dilators
 Exploradores para cálculos biliares, Dilatadores para conductos biliares
 Sonde per calcoli biliari, Dilatatori per condotti biliari



Ø 5,8 cm

Gallensteinlöffel
 Gall Stone Scoops
 Cucharillas para cálculos biliares
 Cucchiari per calcoli biliari

MOOR
 63125-28
 28 cm, 11"



13 Charr.

63130-13

18 Charr.

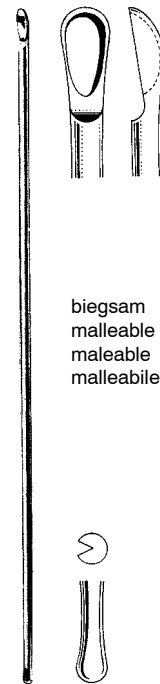
63130-18

21 Charr.

63130-21

federnd
 elastic
 elasticos
 elastiche

DESJARDINS
 63130-13 - 63130-21
 28 cm, 11"



biegsam
 malleable
 maleable
 malleabile

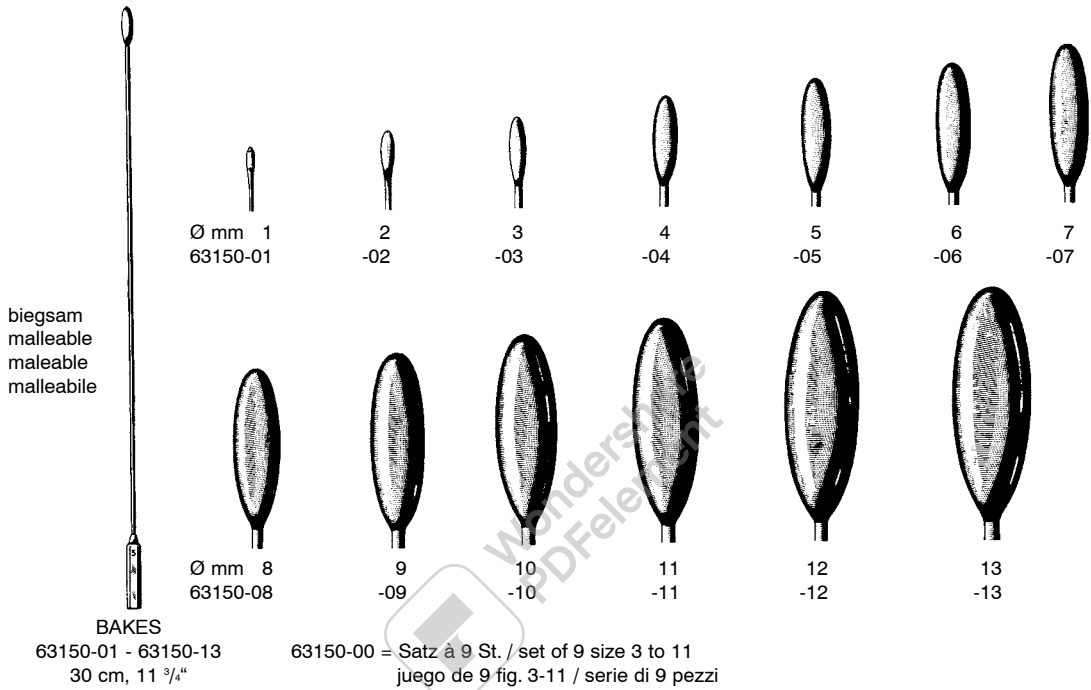
MOYNIHAN
 63142-34 34 cm, 13 1/2"

Gallensteinsonden, Gallengangdilatoren

Gall Stone Probes, Bile duct dilators

Exploradores para cálculos biliares, Dilatadores para conductos biliares

Sonde per calcoli biliari, Dilatatori per condotti biliari

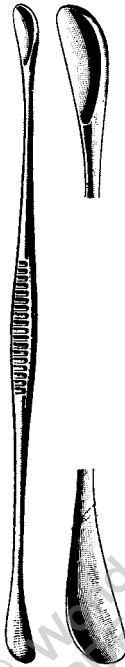


Gallensteinlöffel
 Gall Stone Scoops
 Cucharillas para cálculos biliares
 Cucchiari per calcoli biliari

biegsam
 malleable
 maleables
 malleabile



LUER-KOERTE
 63173-01 - 63173-08
 32 cm, 12 3/4"

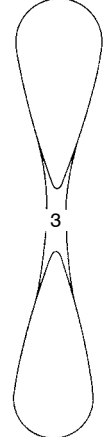
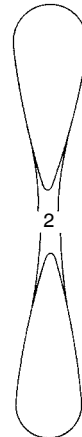
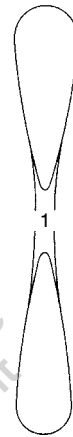


FERGUSSON
 63170-21 - 63170-23

8,5 mm

11,5 mm

12,5 mm



10,5 mm

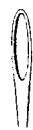
12,5 mm

13,0 mm

63170-21
 21,5 cm
 8 1/2"

63170-22
 22 cm
 8 3/4"

63170-23
 23,5 cm
 9 1/4"



2,5 mm

Fig. 000
 63173-01



3,2 mm

Fig. 00
 63173-02



3,6 mm

Fig. 0
 63173-03



5,5 mm

Fig. 1
 63173-04



6,7 mm

Fig. 2
 63173-05



8,0 mm

Fig. 3
 63173-06



11 mm

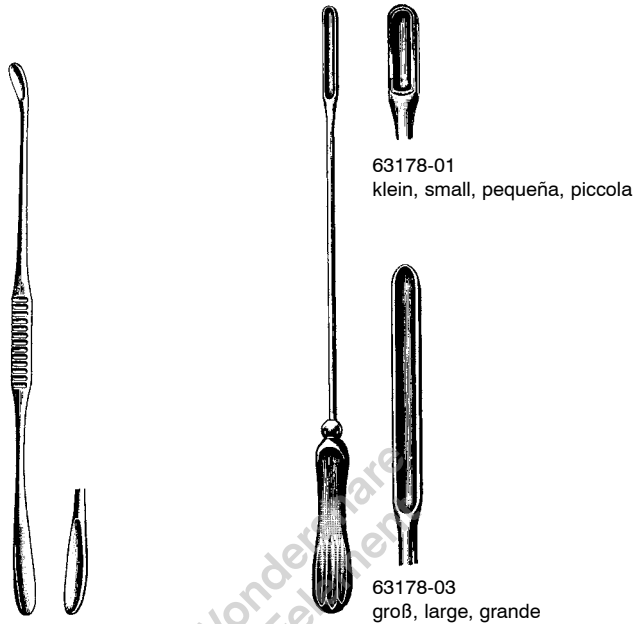
Fig. 4
 63173-07



15 mm

Fig. 5
 63173-08

Gallensteinlöffel, Gallengangsonde
 Gall Stone Scoops, Gall Duct Probes
 Cucharillas para cálculos biliares, sonda para conducto biliar
 Cucchiari per calcoli biliari, sonda per bile



63178-01
 klein, small, pequeña, piccola

63178-03
 groß, large, grande

MAYO
 63175-27
 27 cm, 10 1/2"

MAYO
 63178-01 - 63178-03
 27 cm, 10 1/2"



federnd
 elastic
 elásticas
 elastiche

DESJARDINS
 63180-17 - 63180-27
 30 cm, 11 3/4"

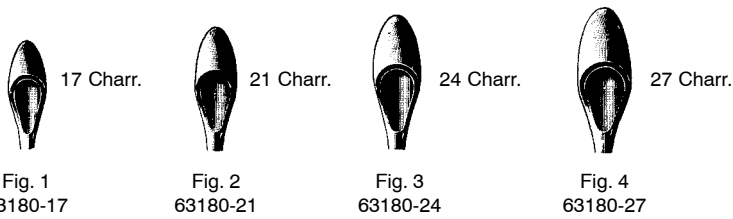


Fig. 1
 63180-17

Fig. 2
 63180-21

Fig. 3
 63180-24

Fig. 4
 63180-27



biegsam
 malleable
 maleable
 malleabile

MAYO
 63210-32
 32 cm, 12 3/4"

Nierensteinzange
Kidney Stone Forceps
Pinzas para cálculos renales,
Pinze per calcoli renali

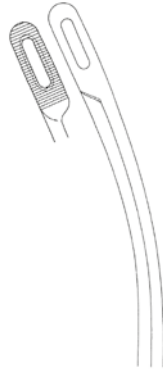


Fig. 1
63231-01 23 cm, 9"

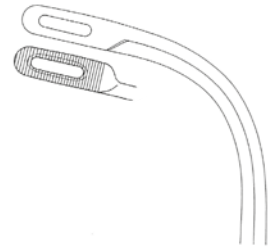


Fig. 2
63231-02 22 cm, 8 3/4"

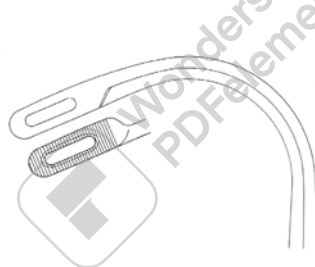


Fig. 3
63231-03 22 cm, 8 3/4"

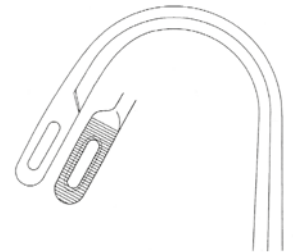


Fig. 4
63231-04 22 cm, 8 3/4"



RANDALL

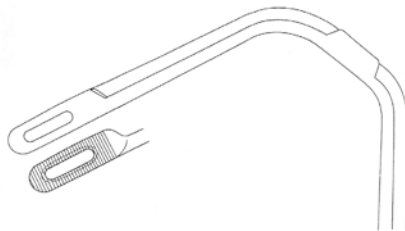


Fig. 5
63231-05 19 cm, 7 1/2"

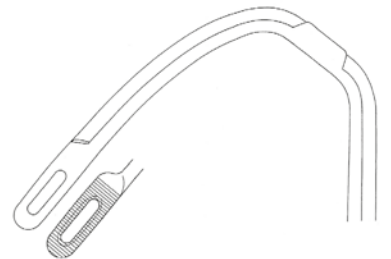
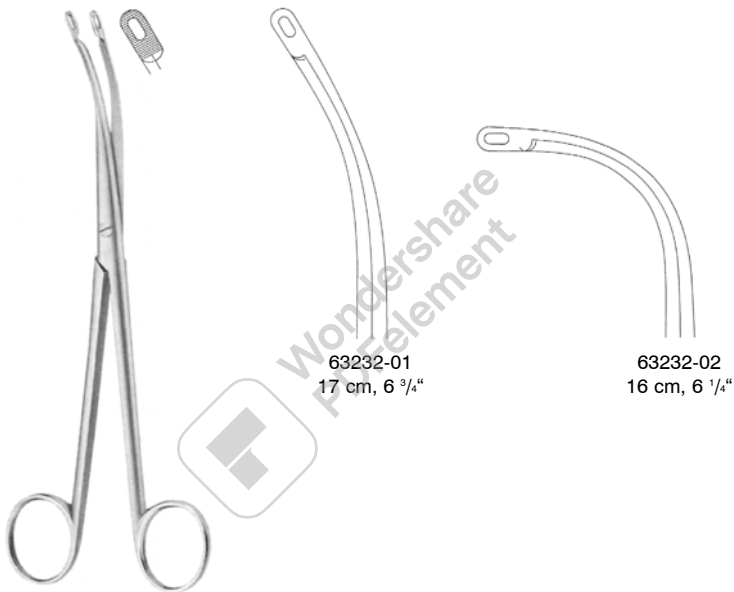


Fig. 6
63231-06 19 cm, 7 1/2"

Nierensteinzange
Kidney Stone Forceps
Pinzas para cálculos renales
Pinze per calcoli renali



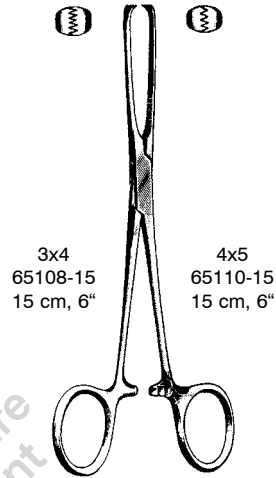
HEIMING

für Kinder
for children
para niños
per bambini

Darm- und Gewebefasszangen
 Intestinal and Tissue Grasping Forceps
 Pinzas para intestinos y tejidos
 Pinze per afferrare intestino e tessuti

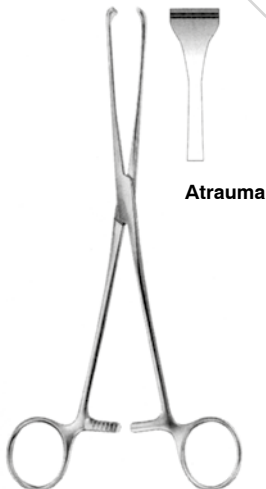


ALLIS-BABY
 65102-12 12 cm, 4 ³/₄"
 65102-14 14 cm, 5 ¹/₂"

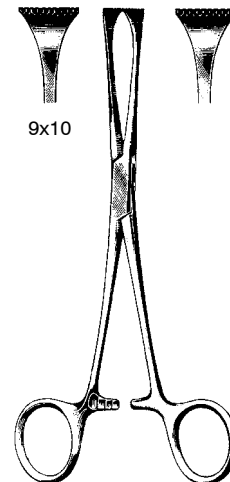


3x4
 65108-15
 15 cm, 6"
 4x5
 65110-15
 15 cm, 6"

ALLIS 5x6
 65120-15 15 cm, 6"
 65120-19 19 cm, 7 ¹/₂"
 65120-22 22 cm, 8 ³/₄"
 65120-24 24 cm, 9 ¹/₂"



ALLIS
 65124-16 16 cm, 6 ¹/₄"
 65124-20 20 cm, 8"
 65124-22 22 cm, 8 ³/₄"
 65124-25 25 cm, 10"
 65124-30 30 cm, 11 ³/₄"

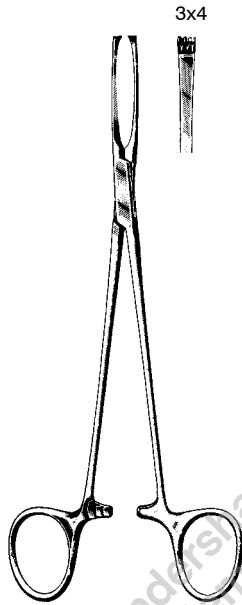


ALLIS-ADAIR
 65130-15
 15,5 cm, 6"

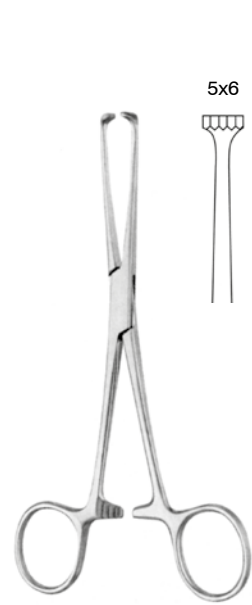
Darm- und Gewebefasszangen
 Intestinal and Tissue Grasping Forceps
 Pinzas para intestinos y tejidos
 Pinze per afferrare intestino e tessuti



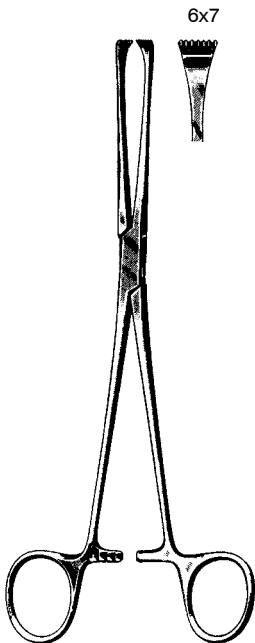
LOCKWOOD-ALLIS
 65132-16 16 cm, 6 1/4"
 65132-20 20 cm, 8"



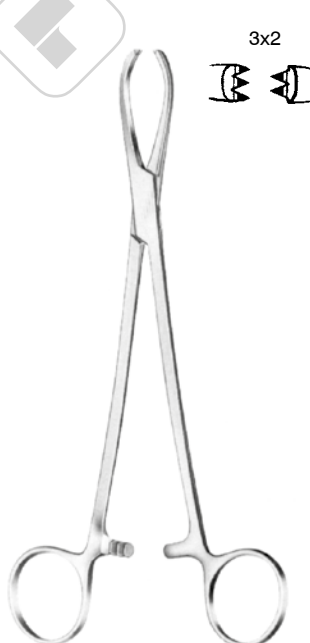
JUDD-ALLIS
 65140-15 15 cm, 6"
 65140-19 19 cm, 7 1/2"



BOYS-ALLIS
 65145-15 15 cm, 6"



THOMS-ALLIS
 65150-20 20 cm, 8"

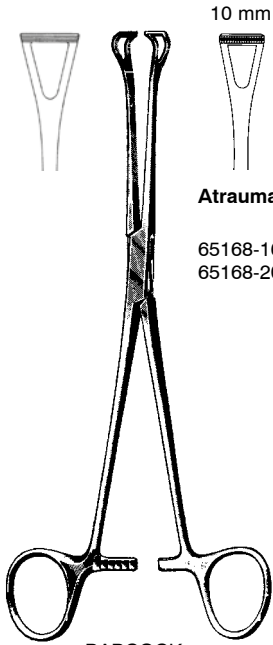


LITTLEWOOD
 65154-18 18,5 cm, 7 1/4"



GREGOIRE
 65155-18 18 cm, 7"
 65155-20 20 cm, 8"

Darm- und Gewebefasszangen Intestinal and Tissue Grasping Forceps Pinzas para intestinos y tejidos Pinze per afferrare intestino e tessuti

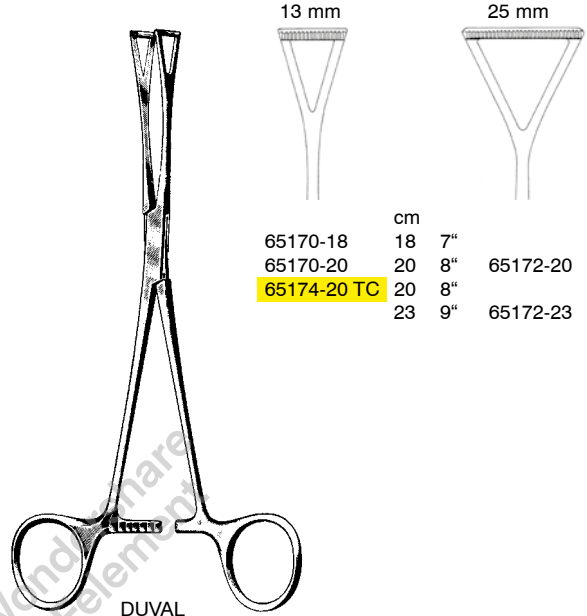


10 mm
Atrauma

- 65168-16 16 cm, 6 1/4"
- 65168-20 20 cm, 8"

BABCOCK

- 65160-14 14 cm, 5 1/2"
- 65160-16 16 cm, 6 1/4" **65164-16 TC 16 cm**
- 65160-18 18 cm, 7"
- 65160-20 20 cm, 8" **65164-20 TC 20 cm**
- 65160-24 24 cm, 9 1/2"

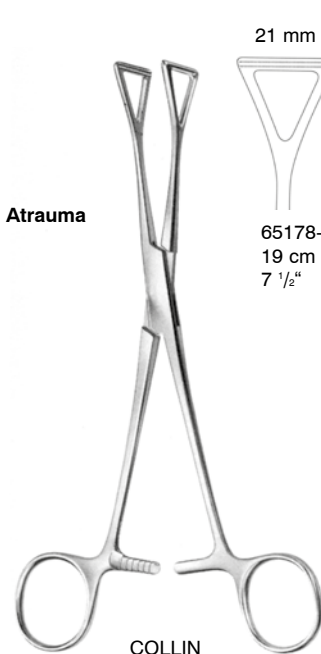


13 mm 25 mm

65170-18	18	7"	
65170-20	20	8"	65172-20
65174-20 TC	20	8"	
	23	9"	65172-23

DUVAL

- 65170-18 - 65172-23



Atrauma

21 mm
65178-19
19 cm
7 1/2"

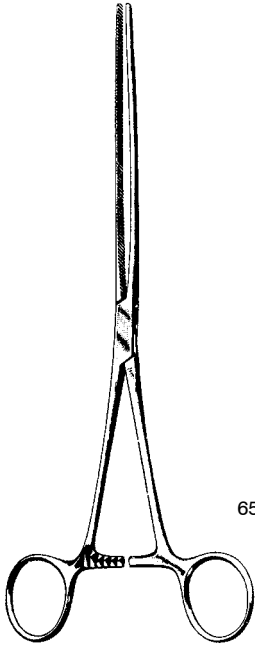
23 mm
65178-23
23 cm
9"

COLLIN

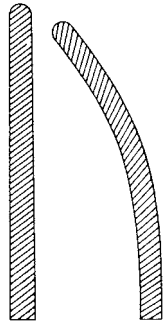


WILLIAMS
65180-16 16,5 cm, 6 1/2"

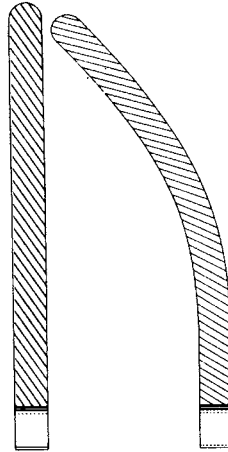
Darmklemmen
 Intestinal Forceps
 Pinzas intestinales
 Pinze intestinali



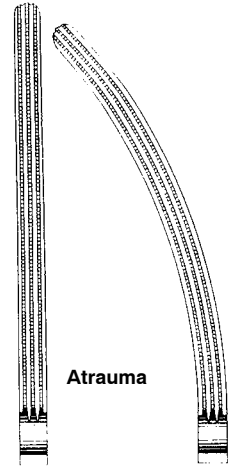
DOYEN
 65210-18 - 65217-23



DOYEN-BABY
 65210-18 65211-18
 18 cm, 7"

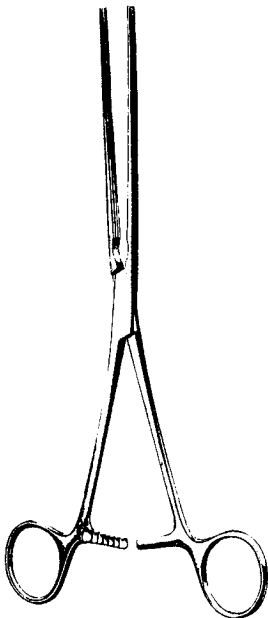


DOYEN
 65210-21 21 cm, 8 1/4" 65211-21
 65210-23 23 cm, 9" 65211-23

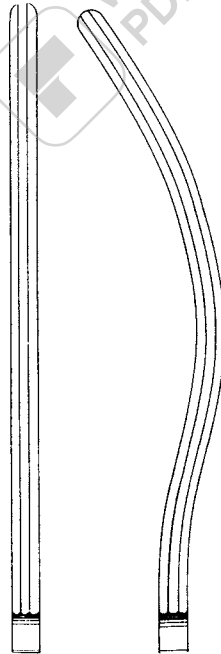


Atrauma

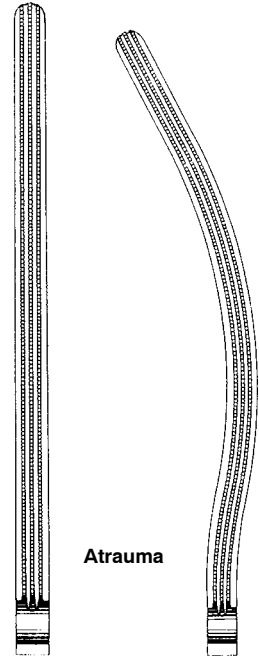
DOYEN
 65216-13 13 cm, 5 1/8" 65217-13
 65216-16 16 cm, 6 1/4" 65217-16
 65216-18 18 cm, 7" 65217-18
 65216-21 21 cm, 8 1/4" 65217-21
 65216-23 23 cm, 9" 65217-23



KOCHER
 65220-22 - 65227-28



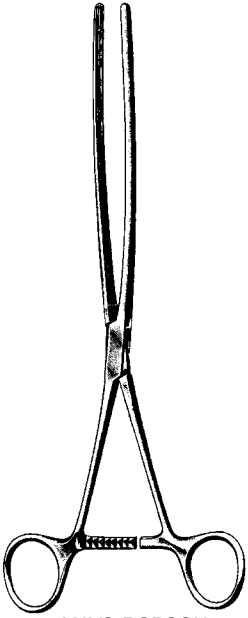
BABY-KOCHER
 65220-13 13 cm, 5 1/8" 65221-13
 65220-22 22 cm, 8 3/4" 65221-22
 65220-25 25 cm, 10" 65221-25
 65220-28 28 cm, 11" 65221-28



Atrauma

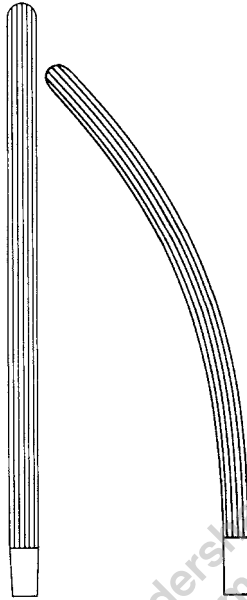
65226-22 22 cm, 8 3/4" 65227-22
 65226-25 25 cm, 10" 65227-25
 65226-28 28 cm, 11" 65227-28

Darmklemmen
Intestinal Forceps
Pinzas intestinales
Pinze intestinali

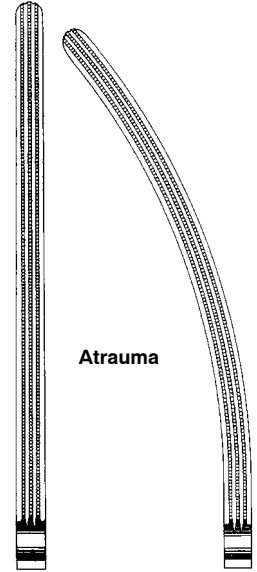


MAYO-ROBSON

65230-21 21 cm, 8 1/4"
65237-25 25 cm, 10"



65230-21 21 cm, 8 1/4" 65231-21
65230-23 23 cm, 9" 65231-23
65230-25 25 cm, 10" 65231-25



Atrauma

65236-25 25 cm, 10" 65237-25

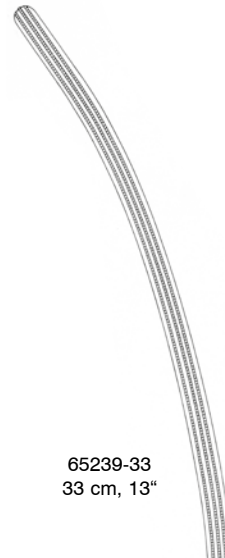


SCUDDER

65238-33
33 cm, 13"



Atrauma



65239-33
33 cm, 13"

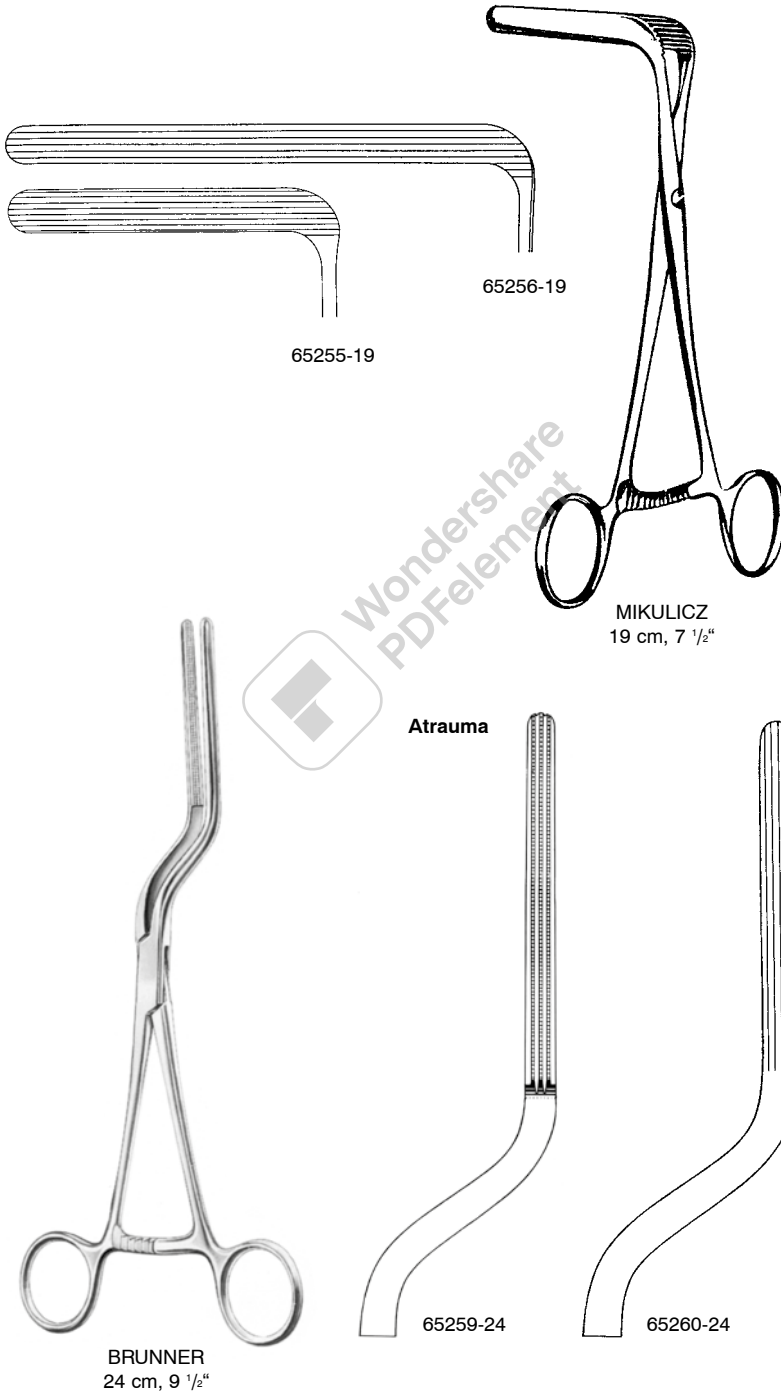
Darmklemmen
Intestinal Forceps
Pinzas intestinales
Pinze intestinali



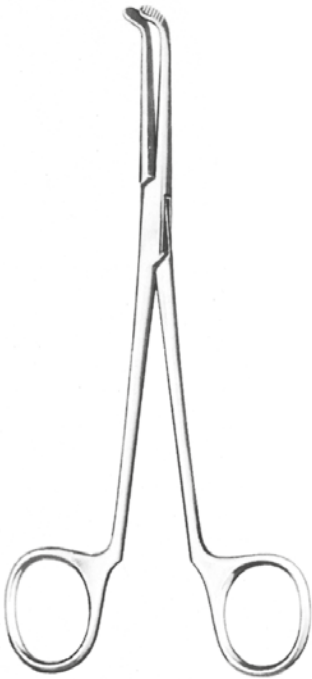
FEHLAND
65241-23
23,5 cm 9 ¹/₄"

RESANO
65242-30
30 cm, 11 ³/₄"

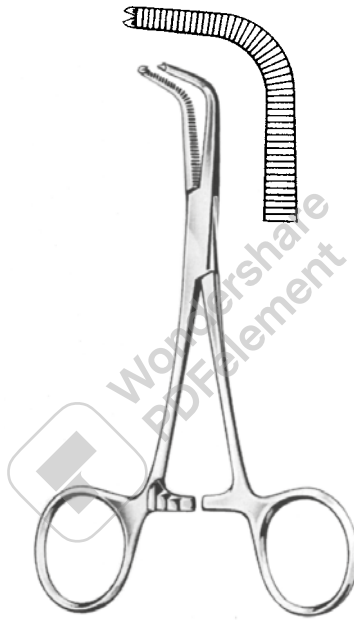
Magen-Darmklemmen
 Intestinal and Stomach Clamps
 Pinzas-clamps intestinales y estomacales
 Pinze intestinali e stomacali



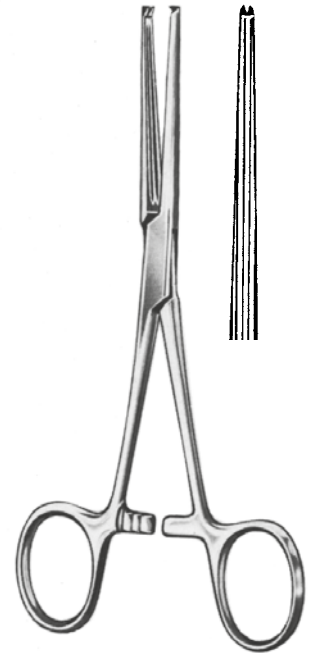
Pyloruspreizer, Blinddarmklemmen
 Pylorus spreader, Blindgut forceps
 Separador para píloro, Pinzas para apéndice
 Divaricatori per piloro, Pinza per appendice



BENSON
 65261-15
 15,5 cm, 6"



KLEINSCHMIDT
 65262-12
 12 cm, 4 3/4"

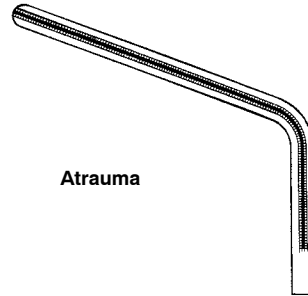


ALLEN
 65263-15 15 cm, 6"
 65263-20 20 cm, 8"

Darm-Anastomosenklemmen
 Intestinal Anastomosis Clamps
 Clamps para anastomosis intestinales
 Pinze per anastomosi intestinali

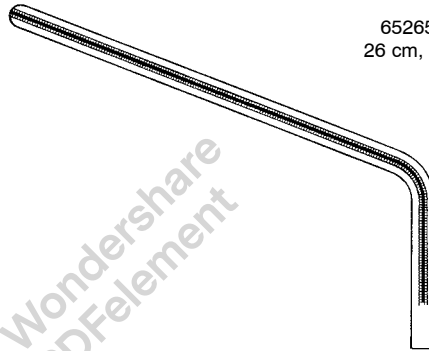


HAYES
 65265-26 26 cm, 10 1/4"
 65265-28 28 cm, 11"



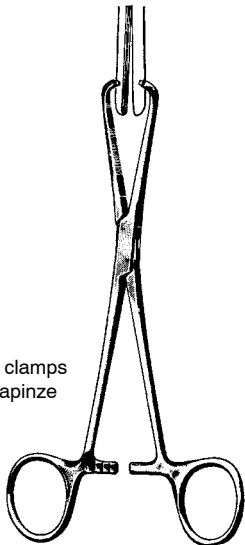
Atrauma

65265-26
 26 cm, 10 1/4"



65265-28
 28 cm, 11"

Schließklemme
 Closing Forceps
 Pinza para cerrar clamps
 Serrapinze e portapinze



STONE-WATT
 65270-15
 15,5 cm, 6"



STONE-WATT
 65272-07 7,5 cm, 3"
 65272-10 10,0 cm, 4"

Klemmschloß
 Locking Device
 Cierre para clamps intestinales
 Serratura per pinze intestinali



STONE-WATT
 65274-00

Darm-Anastomosenklemmen
 Intestinal Anastomosis Clamps
 Clamps para anastomosis intestinales
 Pinze per anastomosi intestinali



DE MARTEL-WOLFSON

65280-05	5 cm, 2"	set of 3
65280-07	7 cm, 2 3/4"	set of 3
65280-10	10 cm, 4"	set of 3



50 mm

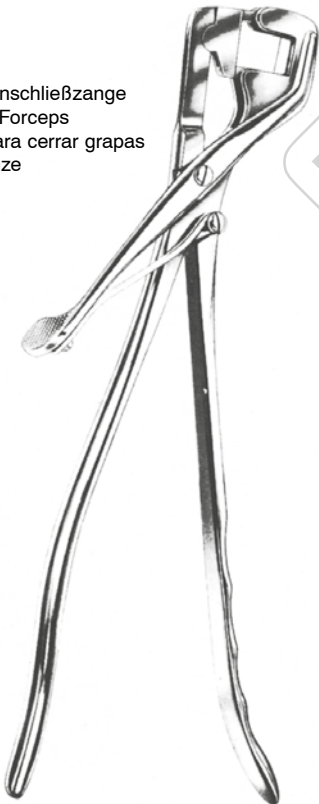


70 mm



100 mm

Klemmschließzange
 Closing Forceps
 Pinza para cerrar grapas
 Serrapinze



DE MARTEL-WOLFSON
 65282-26 26 cm, 10 1/4"

Klemmenhalterung
 Clamp Holder
 Porta-clamp
 Portapinze

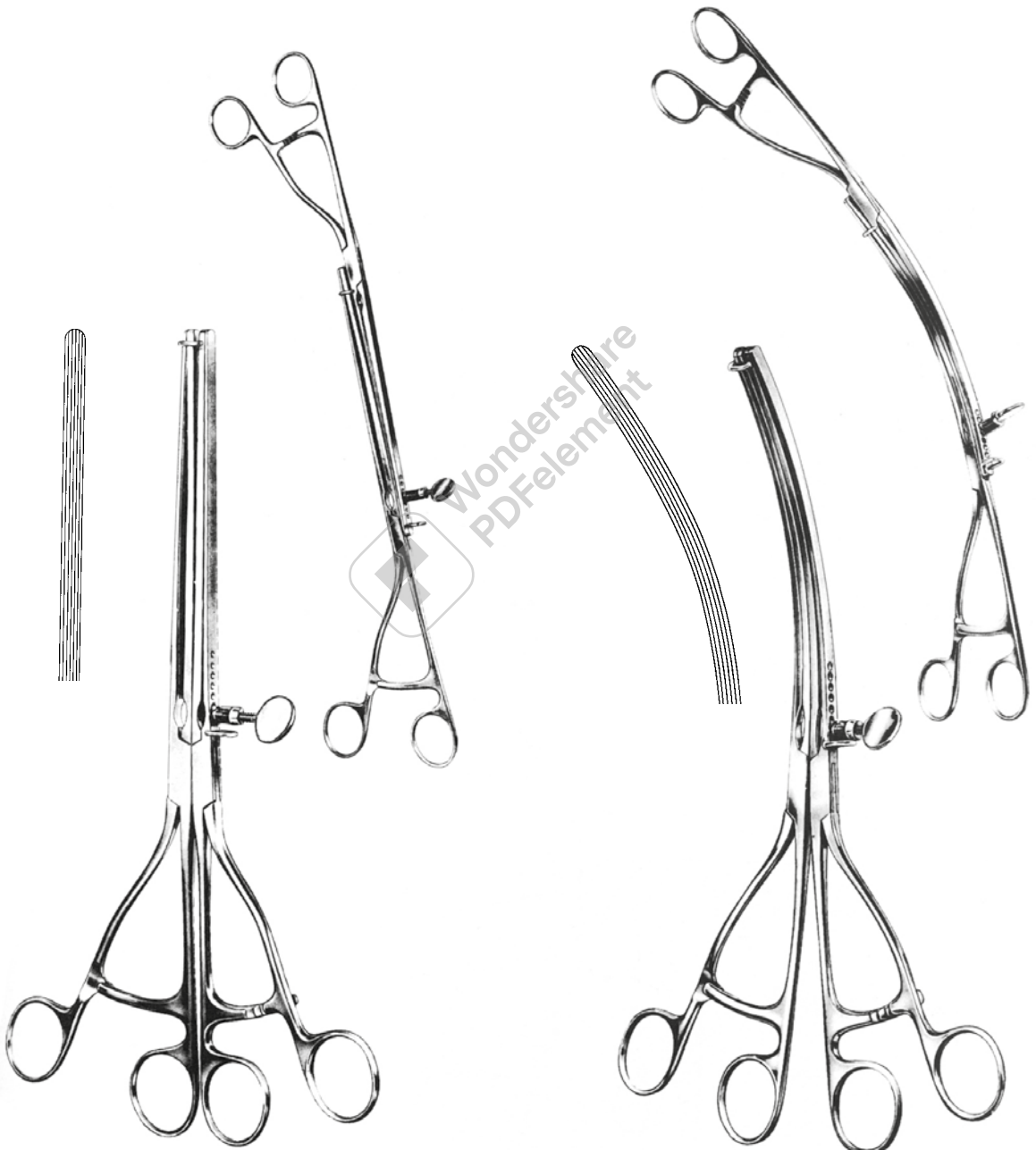


DE MARTEL-WOLFSON
 65284-08 8,5 cm, 3 1/2"



DE MARTEL-WOLFSON
 65284-23 23 cm, 9"

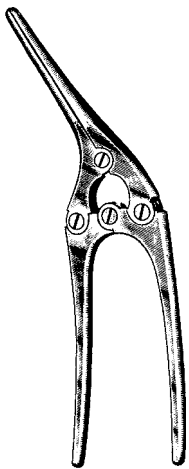
Magen- und Darm-Zwillingsklemmen
Stomach and Intestinal Anastomosis Twin Clamps
Pinzas gastro-intestinales gemales
Pinze gastrointestinali gemelle



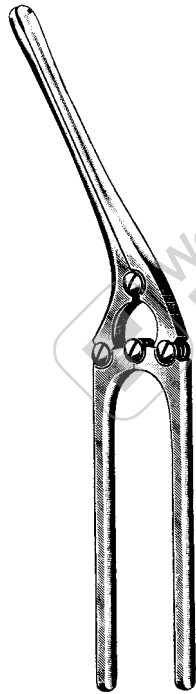
LANE
65290-30 30 cm, 11 3/4"

LANE
65291-30 30 cm, 11 3/4"

Darm- und Magenquetschklemmen
 Intestinal and Stomach Clamps
 Pinzas-clamps intestinales y estomacales
 Pinze e Schiacciatori per l'intestino e lo stomaco



PAYR-BABY
 65310-15
 15 cm, 6"



PAYR



65310-21
 21 cm, 8 1/4"

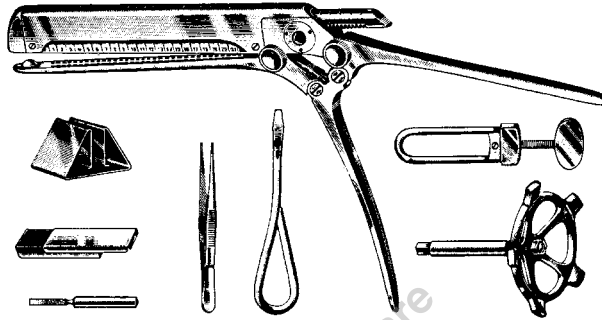


65310-29
 29 cm, 11 1/2"



65310-35
 35 cm, 14"

Magen- und Darmnähhapparat
Stomach and Intestinal Suturing Apparatus
Aparato para suturar estómago e intestinos
Apparecchiature di sutura gastro-intestinale



V. PETZ
65320-00
komplett in Holzetui
compl. in wooden case
en estuche de madera
in astuccio di legno

bestehend aus:

- Nähapparat
- Holzetui
- Zusatzschloß
- Kurbel
- Füllständer
- Füllstift
- Füllpinzette
- Schraubenzieher
- Etui für Klammern
- Silberklammern
(Pack à 300 Stck.)

consisting of:

- suturing apparatus
- wooden case
- additional closing clamp
- gear wheel
- filling rack
- filling pin
- filling tweezer
- screw driver
- metal box for clips
- silver suturing clips
(Pack of 300 ea.)

compuesto de:

- Aparator para suturar
- Estuche de madera
- Cierre adicional
- Manivela
- Soporte para rellenar
- Espiga para rellenar
- Pinza para rellenar
- Destornillador
- Estuche para agrafas
- Agrafas para sutura de plata
(Paquete de 300 pzas.)

composta da:

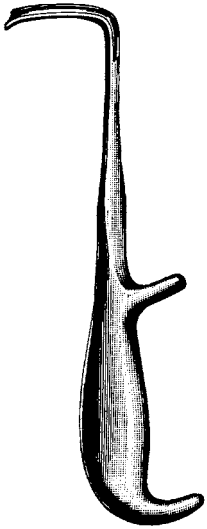
- apparecchio per la sutura
- astuccio in legno
- Serratura supplementare
- manovella
- supporto di riempimento agraiffe
- perno per posizionare le agraiffe
- pinza per caricare
- cacciavite
- scatola in metallo per agraiffe
- agraiffe in argento
(confezione da 300 pezz.)

Prostatahaken, Prostatafaßzange, Kapsel­faßzange

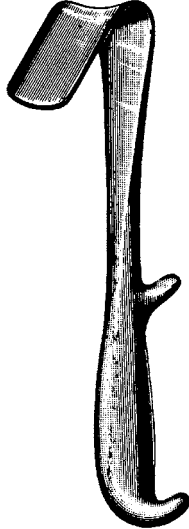
Prostatic retractors, Grasping forceps for the capsule – anterior lobe and ligature carrier

Separador para prostata, pinza de agarre para capsula y prostata

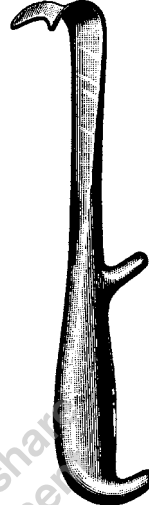
Divaricatori per prostata, pinza per afferrare la capsula e prostata



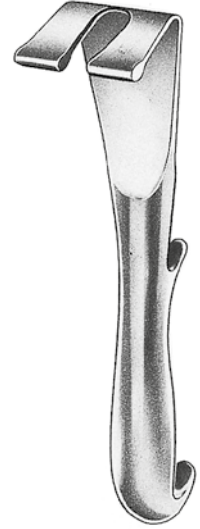
YOUNG
67101-21
21 cm, 8 1/4"



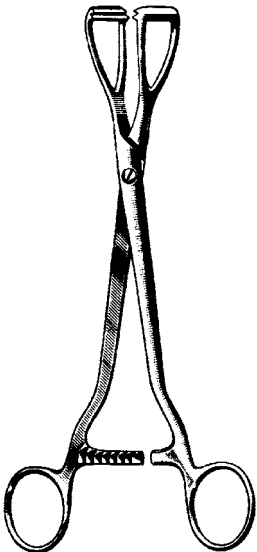
YOUNG
67103-22
22 cm, 8 3/4"



YOUNG
67105-21
21 cm, 8 1/4"



YOUNG
67105-22
22 cm, 8 3/4"

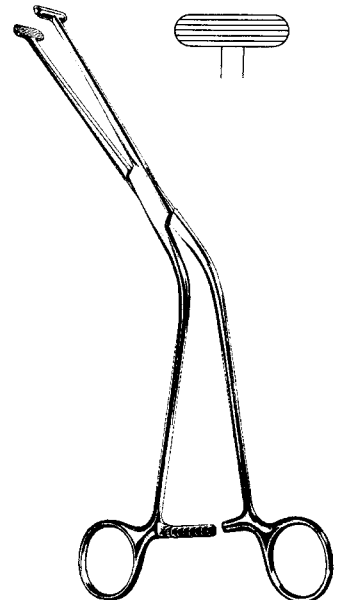


YOUNG
67106-20
20 cm, 8"



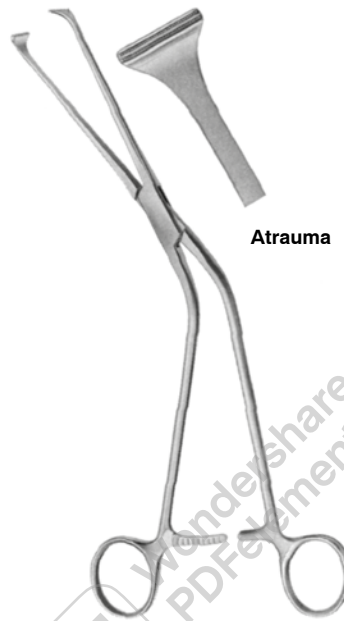
Atrauma

MILLIN
67110-23
23,5 cm, 9 1/4"



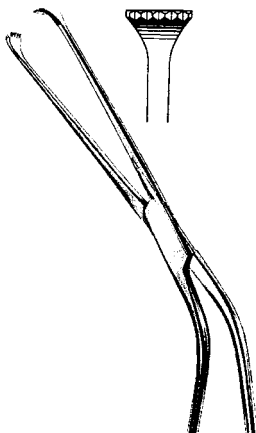
MILLIN
67111-23
23 cm, 9"

Kapselasszange, Fadenführungsazange
Capsule Forceps, Ligature Carrying Forceps
Pinzas capsulares, Pinza porta ligaduras
Pinze per afferrare capsule, Pinza porta-filo

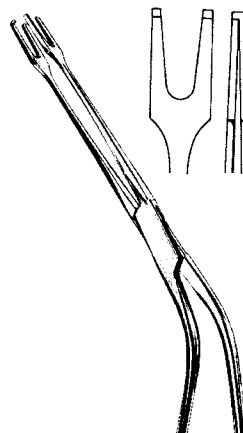


Atrauma

MILLIN
67122-23
24,5 cm, 9 3/4"



MILLIN
67123-23
23 cm, 9"



MILLIN
67125-24
24 cm, 9 1/2"

Blasenwundspreizer, Blasenspatel
Bladder Retractors
Separadores vesicales, Espátula vesical
Divaricatori vescicali, Spatoli vescicali

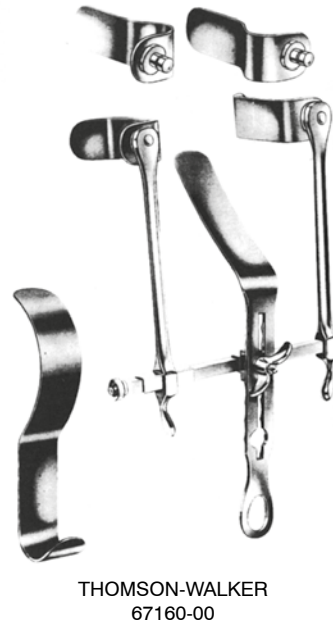
67130-01	2 Valven, 2 blades, 2 valvas, 2 valve	57 mm x 25 mm
67130-02	2 Valven, 2 blades, 2 valvas, 2 valve	80 mm x 25 mm
67130-03	1 Valven, 1 blade, 1 valva, 1 valve	120 mm x 45 mm



- 67130-00 ohne Kaltlicht
- 67132-00 Kaltlichtaufsatz für 67130-00
- 67130-00 without fiber optic
- 67132-00 fiber optic light carrier for 67130-00
- 67130-00 sin soporte de luz fría
- 67132-00 soporte de luz fría para 67130-00
- 67130-00 senza fibre ottiche
- 67132-00 supporto per luce fredda per 67130-00



- 67150-00 mit Mittelvalve, with Central Blade
con valva central, con valva centrale
- 67155-00 ohne Mittelvalve, without Central Blade
sin valva central, senza valva centr.



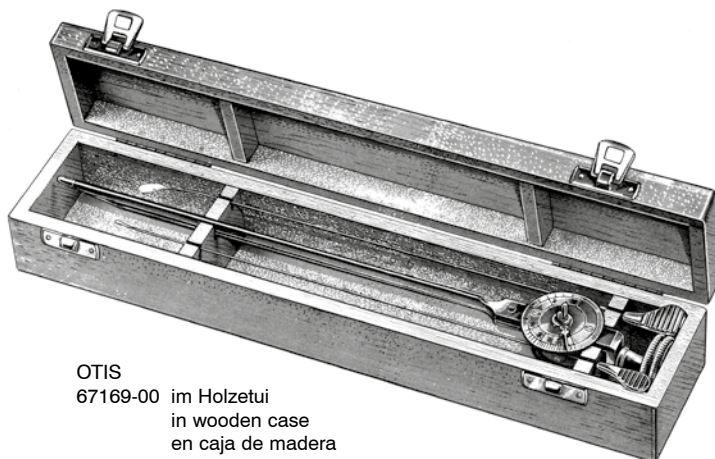
Blasenwundspreizer, Blasenhalssperrer, Urethrotome
 Bladder Retractors, Bladder Neck Spreader, Urethrotomes
 Separadores vesicales, Uretrótomos
 Divaricatori vescicali, Divaricatore del collo vescicale, Uretrótomí



LEGUEU
67163-00



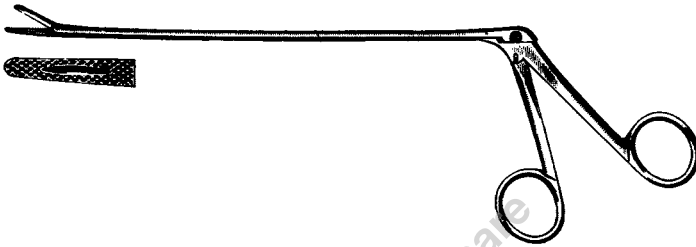
MILLIN
67165-00



OTIS
67169-00 im Holzetui
in wooden case
en caja de madera
in contenitore di legno

67169-01 Ersatzblatt alleine
Blade only
Hoja de repuesto
Lame di ricambio

Fremdkörperzange, Penisklemmen
Foreign Body Forceps, Penis Seizing Forceps
Pinzas para cuerpos extraños, Compresores uretrales
Pinze per corpi estranei, Serrapene

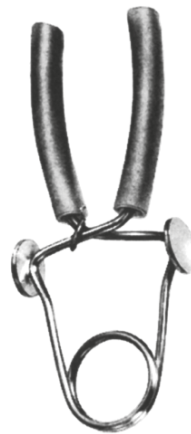


MATHIEU

67172-20 20 cm, 8"
67172-28 28 cm, 11"

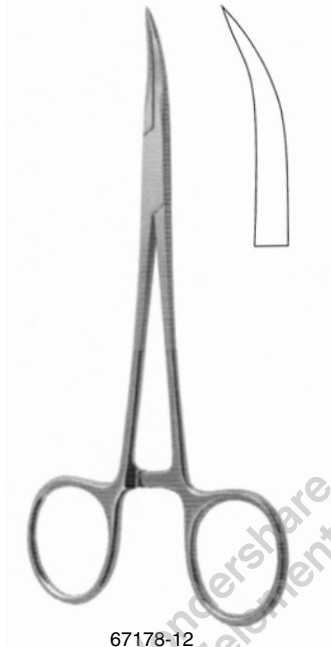


STOCKMANN
67175-08
8 cm, 3 1/8"

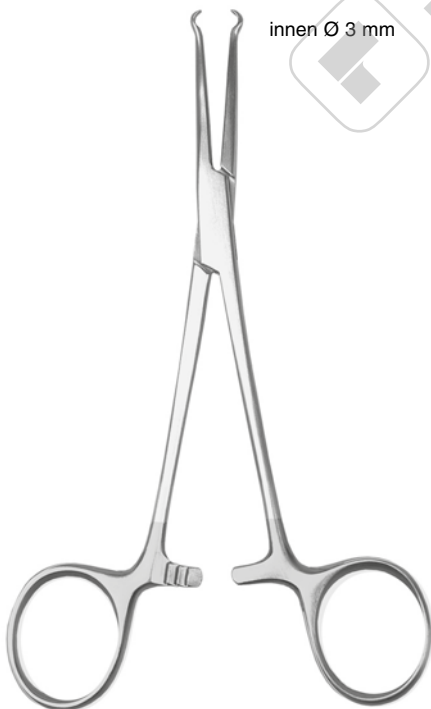


STRAUSS
67177-11
11 cm, 4 3/8"

Vasektomie-Klemme
Vasectomy Forceps
Pinza para vasectomia
Pinza per vasectomia



67178-12
12 cm, 4 3/4"



67178-14
14 cm, 5 1/2"



67179-14
14,5 cm, 5 3/4"

Kathetereinführungsinstrumente, Dilatationsbougies
Catheter Introducer, Dilating Bougies
Introducer de catéteres, Bujías dilatadoras
Mandrini per sonde uretrali, Candelette dilatatrici



Metallkatheter
Metal Catheters
Sondas metálicas
Sonde metalliche



29 cm
11 1/2"

15 cm
6"

COXETER

Charr.
FG

6	67211-06	67213-06	
8	67211-08	67213-08	67219-08
10	67211-10	67213-10	67219-10
12	67211-12	67213-12	67219-12
14	67211-14	67213-14	67219-14
16	67211-16	67213-16	67219-16
18	67211-18	67213-18	67219-18
20	67211-20	67213-20	67219-20
22	67211-22	67213-22	67219-22
24	67211-24	67213-24	67219-24

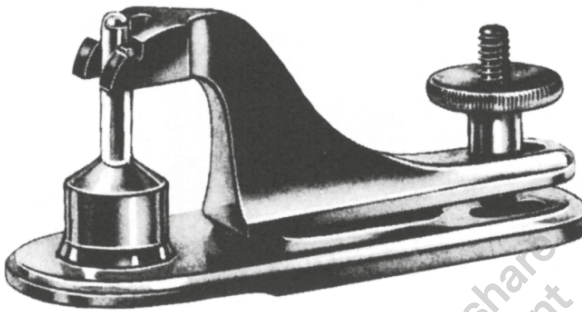


WALTHER FEMALE DILATOR-CATHETERS

5 1/4"
67220-00 (Set)

67220-12	12 Fr.
67220-14	14 Fr.
67220-16	16 Fr.
67220-18	18 Fr.
67220-20	20 Fr.
67220-22	22 Fr.
67220-24	24 Fr.
67220-26	26 Fr.
67220-28	28 Fr.
67220-30	30 Fr.
67220-32	32 Fr.
67220-34	34 Fr.
67220-36	36 Fr.
67220-38	38 Fr.

Beschneidungsinstrument
Circumcision Instrument
Instrumentos para circuncisión
Strumenti per circoncisione



67240-08	8 mm Ø
67240-11	11 mm Ø
67240-13	13 mm Ø
67240-16	16 mm Ø
67240-21	21 mm Ø
67240-26	26 mm Ø
67240-32	32 mm Ø

67240-08 - 67240-32



MOGEN

67250-07	7,5 cm (3")	2,5 mm
67251-07	7,5 cm (3")	1,5 mm
		für Kinder
		for children
		para niños
		per bambini

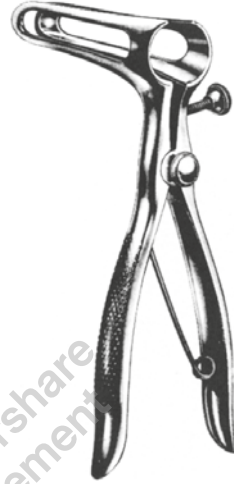




Mastdarm-Spekula
Rectal Specula
Espécules rectales
Specoli rettali



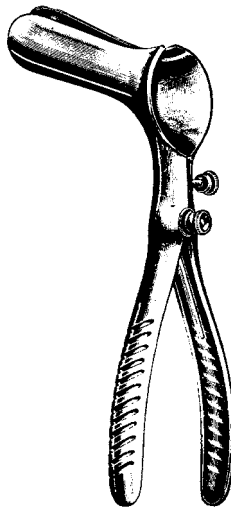
CZERNY
69105-22
22 cm, 8 ³/₄"



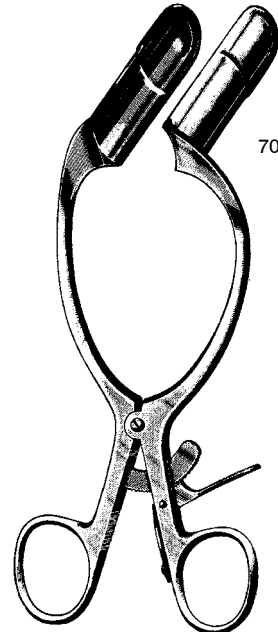
SIMS
69110-15
15 cm, 6"



BODENHAMMER
69115-15
15 cm, 6"



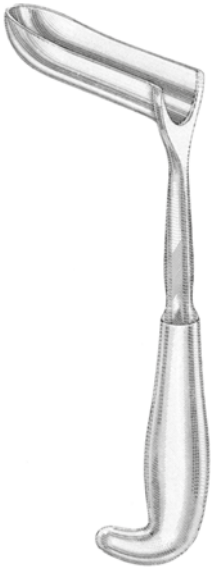
PRATT
69121-00
19 cm, 7 ¹/₂"



BARR
69125-17
17 cm, 6 ³/₄"

70x22 mm

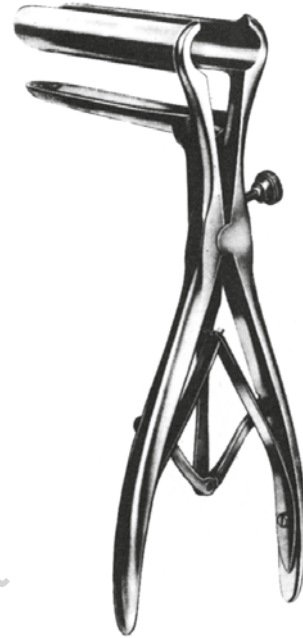
Mastdarm-Spekula
Rectal Specula
Espécúlos rectales
Specoli rettali



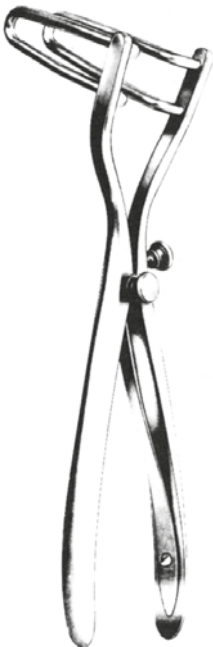
HILL-FERGUSON, 20 cm, 8"
69126-01 6,4x2,2 cm 2 1/2" x 7/8"
69126-02 7,6x3,0 cm 3" x 1 1/16"
69126-03 7,6x3,6 cm 3" x 1 7/16"



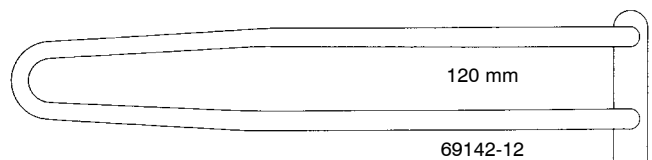
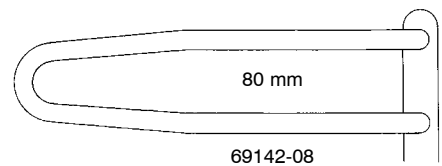
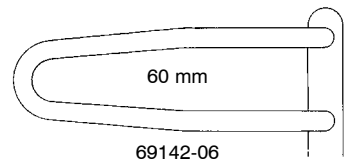
SAWYER, 25 cm, 9 3/4"
69127-01 6,4x2,2 cm 2 1/2" x 7/8"
69127-02 7,6x2,9 cm 3" x 1 1/8"
69127-03 8,9x3,8 cm 3 1/2" x 1 1/2"



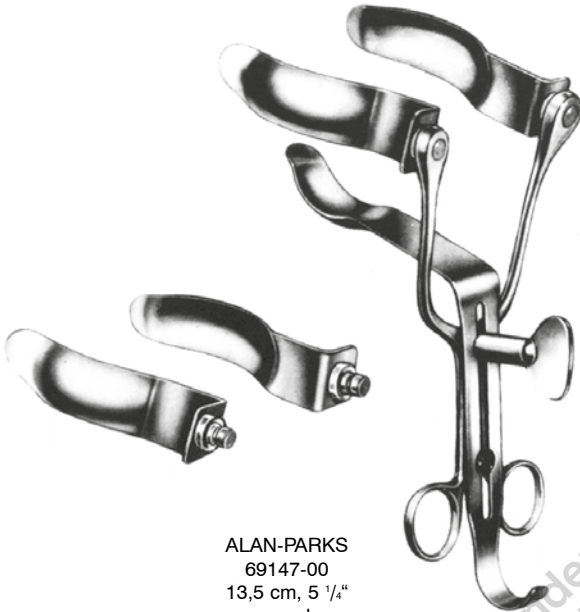
MATHIEU
69130-19
19,5 cm, 7 3/4"



SCHULZE-BERGMANN
69142-06 - 69142-12



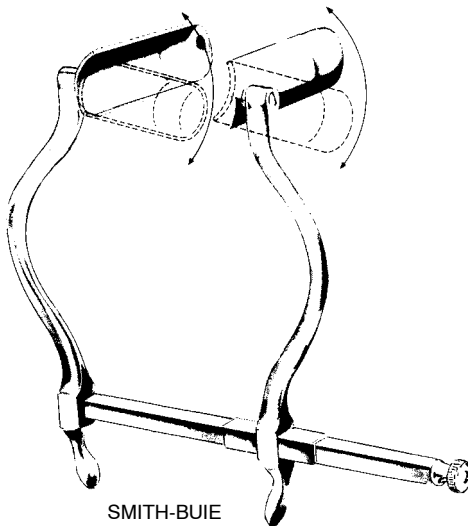
Anal spreizer
Anal Retractors
Separadores rectales
Dilatatori per l'ano e il retto



ALAN-PARKS
69147-00
13,5 cm, 5 1/4"
compl.

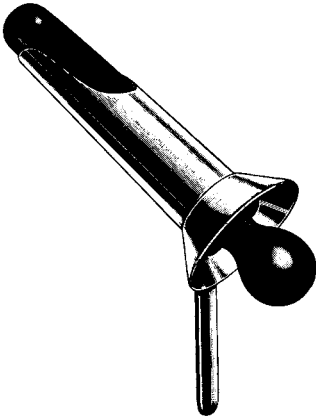
69148-00
Kaltlicht Zubehör für 69147-00
Cold Light Attachment for 69147-00
Adaptador para luz fría 69147-00
Adattatore luce fredda per 69147-00

- 69147-01 Sperrer allein
Spreader only
Separador rectal solo
Solo telaio senza valve
- 69147-02 Mittelblatt allein
Center blade, only
Valva central, solo
Valva centrale, sola
- 69147-03 Blatt allein 75 mm, 3"
Blade only 75 mm, 3"
Valva sola 75 mm, 3"
Valva sola 75 mm, 3"
- 69147-04 Blatt allein 95 mm, 3 3/4"
Blade only 95 mm, 3 3/4"
Valva sola 95 mm, 3 3/4"
Valva sola 95 mm, 3 3/4"



SMITH-BUIE
69150-15
15 cm, 6"
75x23 mm

Anuskope, Proktoskope
Anoscopes, Proctoscopes
Anoscopios, Proctoscopios
Anoscopi, Protoscopi



IVES-FANSLER
69210-22 22 mm Ø
L = 80 mm



Ø mm HIRSCHMANN
16 69212-16
19 69212-19
22 69212-22
L = 65 mm

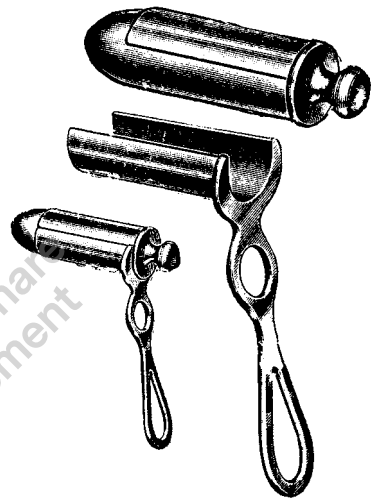


mm
ØxL KELLY
22x 50 69220-05
22x100 69220-10
22x140 69220-14
22x200 69220-20

Sphinkteroskope, Proktoskope, Fistelsonde
Sphincteroscopes, Proctoscopes, Fistula Probe
Sfinteroscopios, Proctoscopios, Sondas para fistulas
Sfinteroscopi, Protoscopi, Sonde per fistole



Ø mm KELLY
21 69224-21
27 69224-27
L = 50 mm, 2"



Ø mm CHELSEA-EATON
22 x 65 69225-22
30 x 65 69225-30



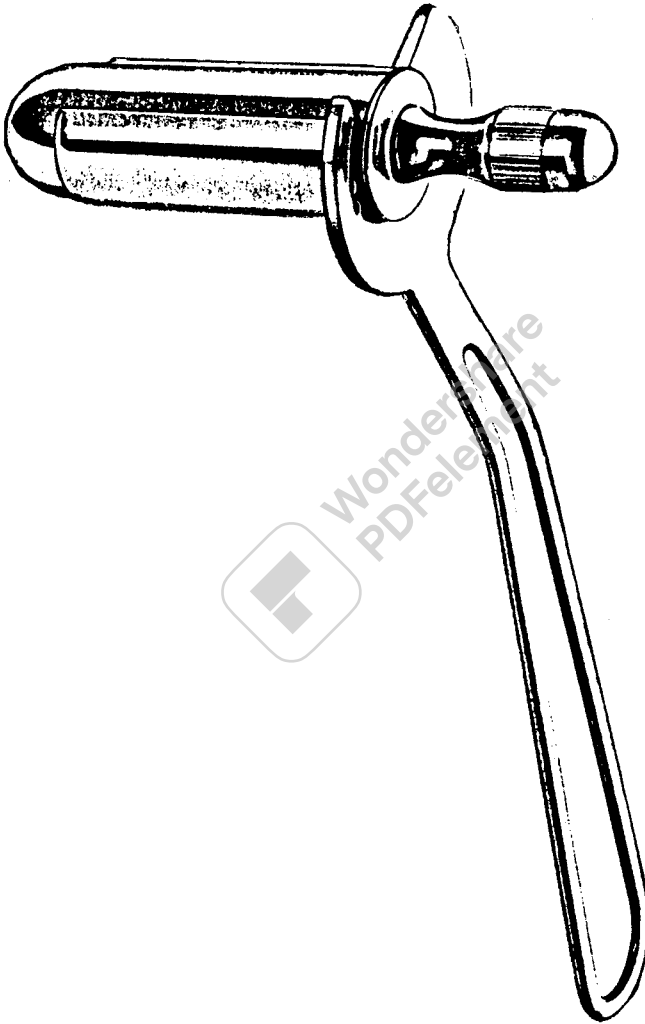
Fig. 1
69251-01

Fig. 2
69251-02

Fig. 3
69251-03

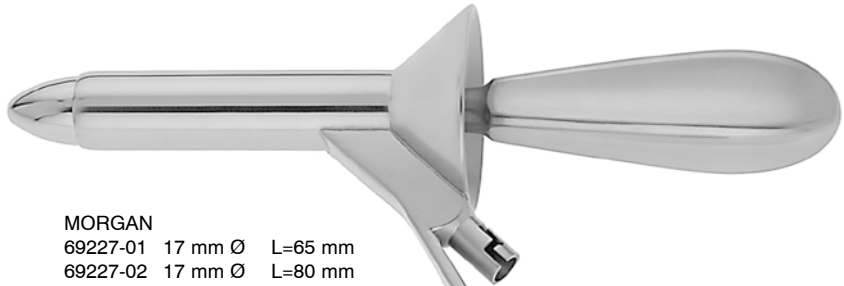
PRATT
21 cm, 8 1/4"
69251-01 - 69251-03

Proktoskope
Proctoscopes
Proctoscopios
Protoscopi



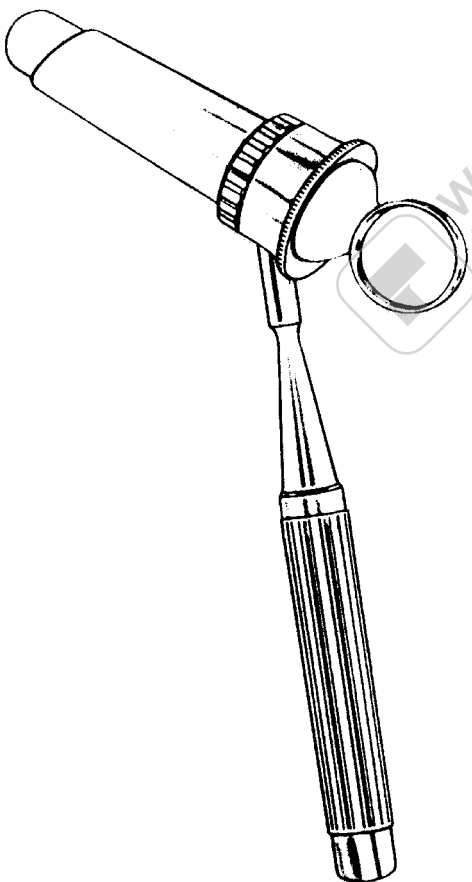
Ø	L	FANSLER, 24 cm, 9 1/2"
25 x 65 mm	69226-25	
29 x 65 mm	69226-29	
38 x 70 mm	69226-38	

Proktoskope
Proctoscopes
Proctoscopios
Protoscopi



MORGAN

69227-01	17 mm Ø	L=65 mm
69227-02	17 mm Ø	L=80 mm
69227-03	20 mm Ø	L=65 mm
69227-04	20 mm Ø	L=80 mm
69227-05	24 mm Ø	L=65 mm
69227-06	24 mm Ø	L=80 mm



BENSAUDE

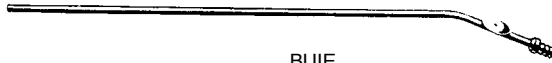
69229-01	19 mm Ø	L=70 mm
69229-02	22 mm Ø	L=70 mm



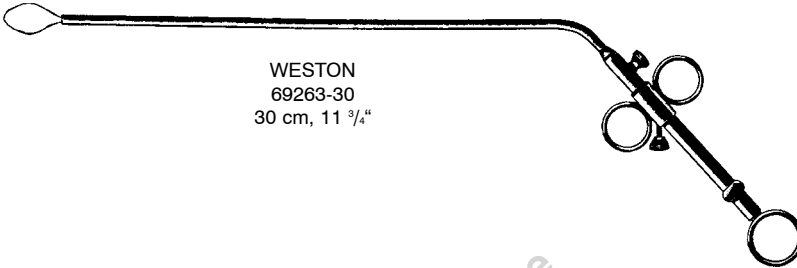
69228-01

Beleuchtungsstab für MORGAN
Illumination attachment for MORGAN
Mango con iluminacion para MORGAN
Dispositivo Illuminativo per MORGAN

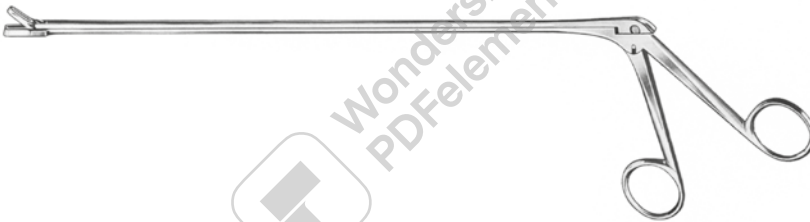
Rektal Absaugrohr, Rektalschnürer, Mastdarmbiopsiezangen
 Rectal aspiration cannula, Rectal snare, Rectal Biopsy Specimen Forceps
 Cánula de aspiración rectal, Cierra-nudo rectal, Pinzas para biopsia rectal
 Cannula d'aspirazione rettale, Serranodi, Pinze taglianti per biopsia rettale



BUIE
 69261-41
 41 cm, 16"



WESTON
 69263-30
 30 cm, 11 3/4"



YEOMAN
 69301-28 - 69304-42

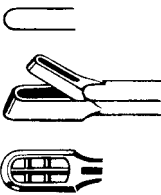


Fig. 1
 69301-28 28 cm, 11"
 69301-35 35 cm, 13 3/4"
 69301-42 42 cm, 16 1/2"

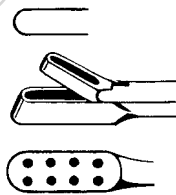


Fig. 2
 69302-28 28 cm, 11"
 69302-35 35 cm, 13 3/4"
 69302-42 42 cm, 16 1/2"

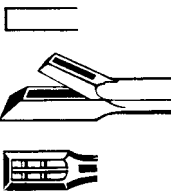


Fig. 3
 69303-28 28 cm, 11"
 69303-35 35 cm, 13 3/4"
 69303-42 42 cm, 16 1/2"

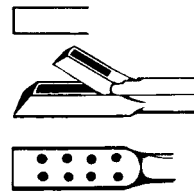
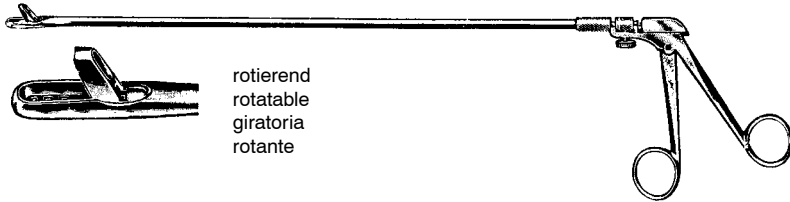


Fig. 4
 69304-28 28 cm, 11"
 69304-35 35 cm, 13 3/4"
 69304-42 42 cm, 16 1/2"

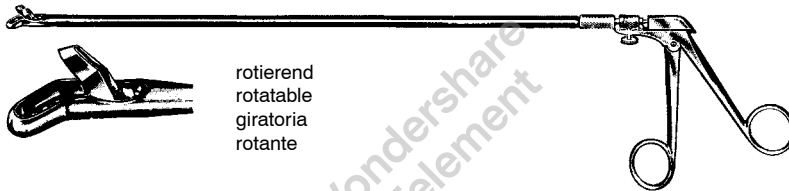
Mastdarm-Biopsiezangen, Hämorrhoidalzange
 Rectal Biopsy Specimen Forceps, Haemorrhoidal Forceps
 Pinzas para biopsia rectal, Pinzas-clamps hemorroidales
 Pinze taglianti per biopsia rettale, Pinze per emorroidi



rotierend
 rotatable
 giratoria
 rotante

YEOMANN

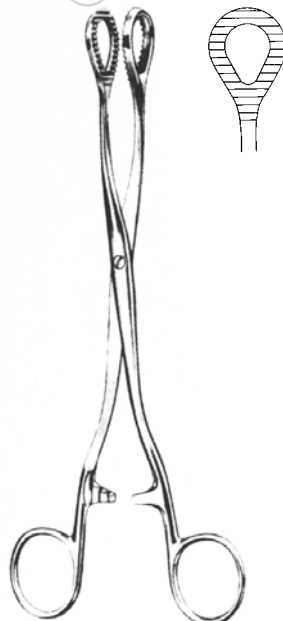
69311-23 23 cm, 9"
 69311-33 33 cm, 13"
 69311-40 40 cm, 15 3/4"



rotierend
 rotatable
 giratoria
 rotante

TURREL

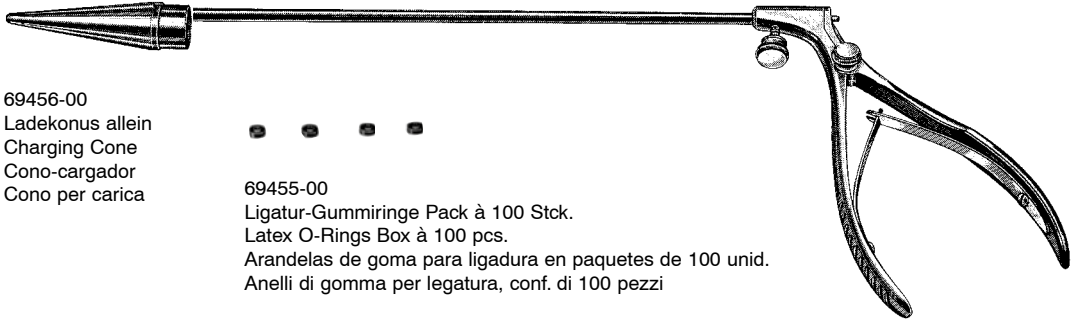
69321-23 23 cm, 9"
 69321-33 33 cm, 13"
 69321-40 40 cm, 15 3/4"



HEYWOOD-SMITH

69402-21 21 cm, 8 1/4"
 69402-25 25 cm, 10"

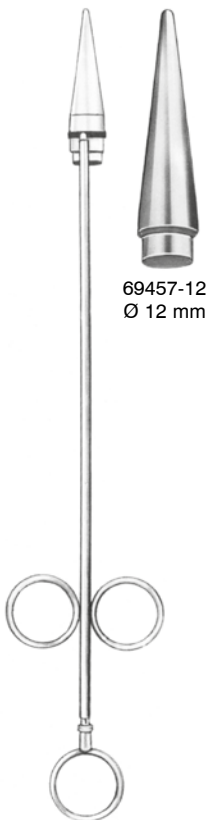
Hämorrhoidal-Ligatoren, Hämorrhoidal-Fasszange
 Haemorrhoidal Ligators, Haemorrhoidal Forceps
 Ligadores para hemorroides, Pinzas-clamps para hemorroides
 Legatori emorroidali, Pinze per emorroidi



69456-00
 Ladekonus allein
 Charging Cone
 Cono-cargador
 Cono per carica

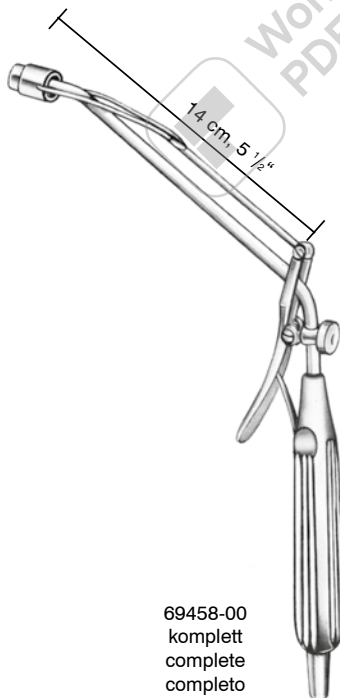
69455-00
 Ligatur-Gummiringe Pack à 100 Stck.
 Latex O-Rings Box à 100 pcs.
 Arandelas de goma para ligadura en paquetes de 100 unid.
 Anelli di gomma per legatura, conf. di 100 pezzi

MC GIVNEY
 69450-18
 18 cm, 7"

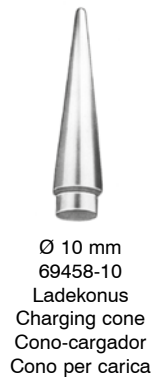


69457-12
 Ø 12 mm

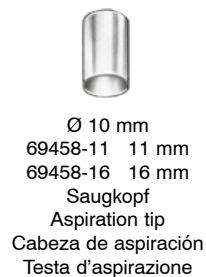
RUDD
 69457-31
 31,5 cm, 12 1/2"
 kplt./cpt.



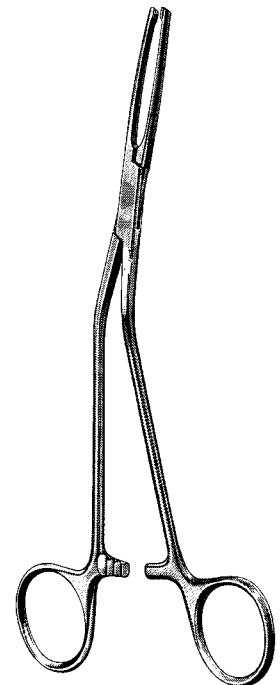
69458-00
 komplett
 complete
 completo



Ø 10 mm
 69458-10
 Ladekonus
 Charging cone
 Cono-cargador
 Cono per carica

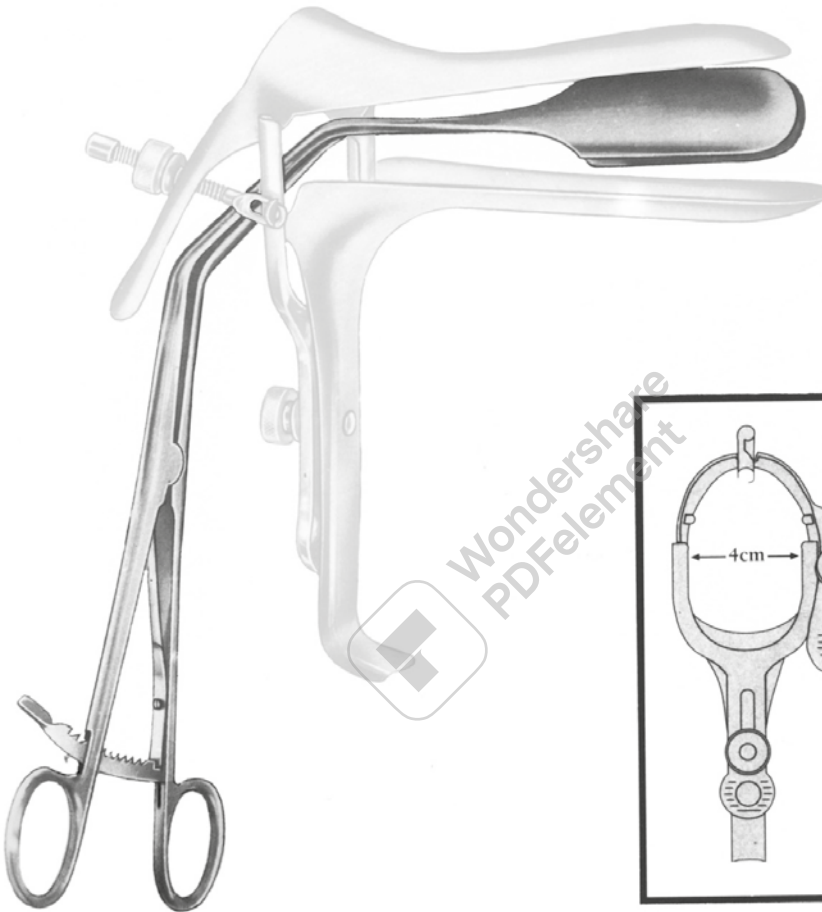


Ø 10 mm
 69458-11 11 mm
 69458-16 16 mm
 Saugkopf
 Aspiration tip
 Cabeza de aspiración
 Testa d'aspirazione



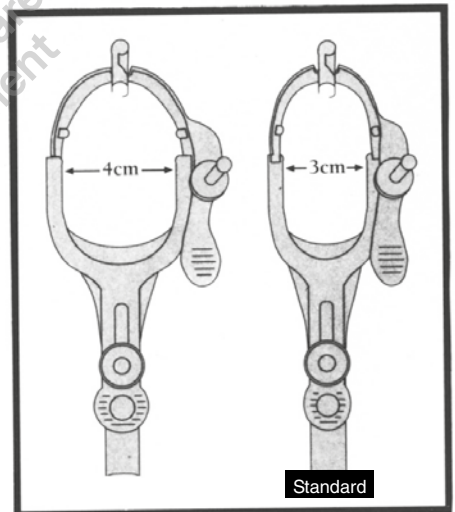
MC GIVNEY
 69460-00
 19 cm, 7 1/2"

Lateral-Scheidenspekula
Lateral Vaginal Retractor
Espéculos vaginales
Specoli vaginali



71100-00

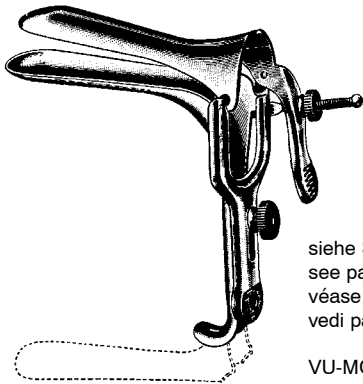
Lateralspreizer allein
Vaginal retractor lateral only
Espéculo vaginal solo
Specolo vaginale laterale, solo



VU-MORE

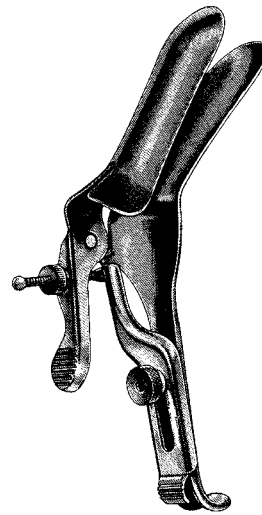
Fig.	mm	
2	95x35	71115-02
3	115x35	71115-03

Scheidenspekula
Vaginal Specula
Espéculos vaginales
Specoli vaginali



siehe Seite 569
see page no. 569
véase pagina no. 569
vedi pagina nr. 569

VU-MORE



rechts offen
open right-side
abierto a la derecha
aperta a destra

GRAVE

Fig.	mm	Standard
1	75x20	71110-01
2	95x35	71110-02
3	115x35	71110-03

GRAVE

Fig.	mm	Standard
1	75x20	71110-01
2	95x35	71110-02
3	115x35	71110-03

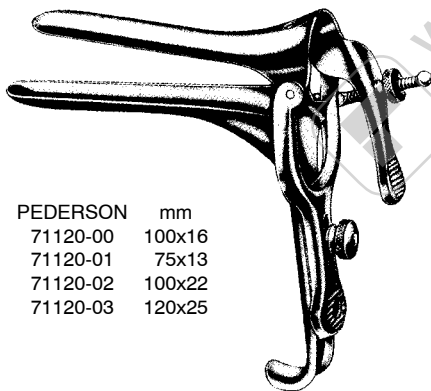


Fig.	PEDERSON	mm
	71120-00	100x16
1	71120-01	75x13
2	71120-02	100x22
3	71120-03	120x25

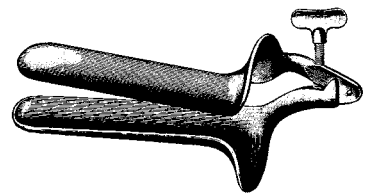
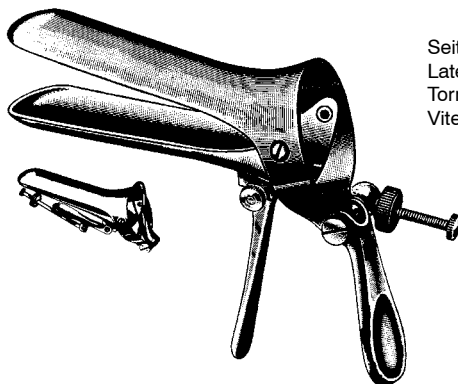


Fig.	COLLIN	mm
1	71130-01	85x30
2	71130-02	100x35
3	71130-03	110x40

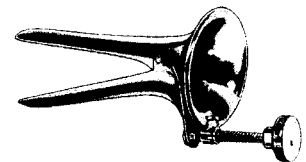


Seitliche Schraube
Lateral Screw
Tornillo lateral
Vite laterale

CUSCO

Fig.	mm	Standard
1	75x32	71140-01
2	85x35	71140-02
3	100x35	71140-03
4	75x17	71142-04

für Jungfrauen
for virgin
para vírgenes
per vergini



COLLIN
71132-00
65x10 mm

Scheidenspekula
Vaginal Specula
Espécúlos vaginales
Specoli vaginali

Mittelschraube
Central Screw
Tornillo central
Vite centrale

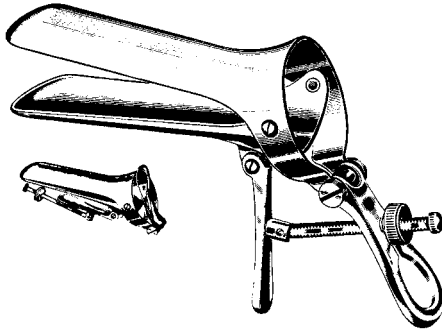


Fig.	CUSCO	mm
1	71150-01	75x32
2	71150-02	85x35
3	71150-03	100x37

Schweizer Modell
Swiss Pattern
Modelo suizo
Modello svizzero

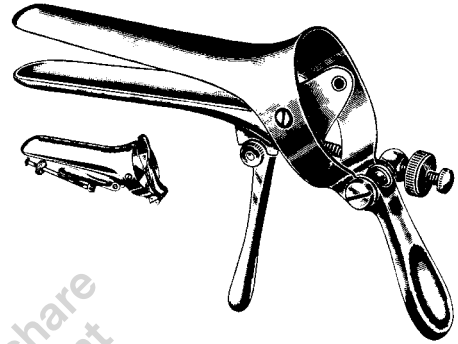
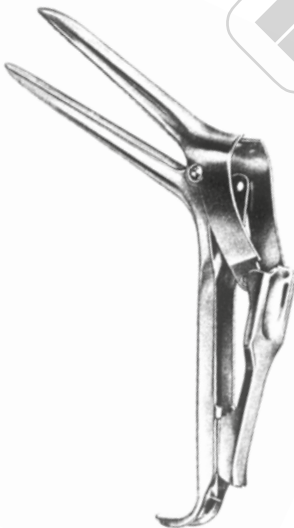


Fig.	CUSCO	mm
1	71160-01	90x23-25
2	71160-02	100x25-27
3	71160-03	110x27-30



	SEMM	mm
71161-17	100 x 17 - 20 mm	
71161-25	100 x 25 - 30 mm	

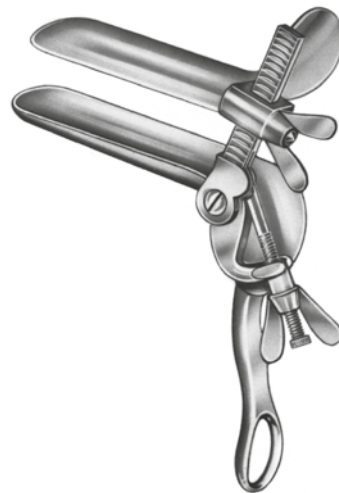


Fig.	TRÉLAT	mm
1	71170-01	85x33
2	71170-02	95x35
3	71170-03	115x43

Scheidenspekula
Vaginal Specula
Espéculos vaginales
Specoli vaginali

Satz bestehend aus je 1 Spekula und 1 Halter
Set consisting of 1 specula and 1 retractor
Juego de 1 espéculo y 1 valva
Serie da 1 specolo e 1 valva

Spekula
Speculum
Espéculo
Specolo

Halter
Retractor
Valva
Valve



Fig. KRISTELLER
1 71210-01
2 71210-02
3 71210-03



Fig. KRISTELLER mm
1 71211-01 70x27
2 71211-02 80x30
3 71211-03 90x36



Fig. KRISTELLER mm
1 71212-01 75x23
2 71212-02 85x26
3 71212-03 100x32



Fig. KRISTELLER
00 71240-00
0 71240-10
1 71240-01
2 71240-02
3 71240-03

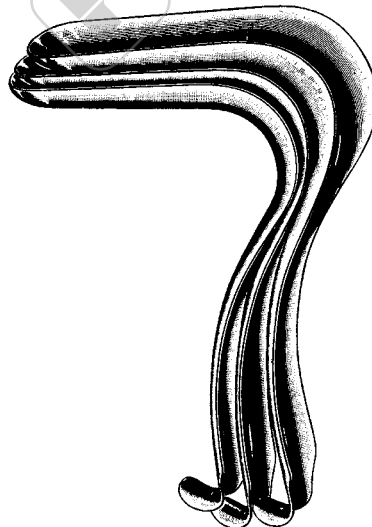
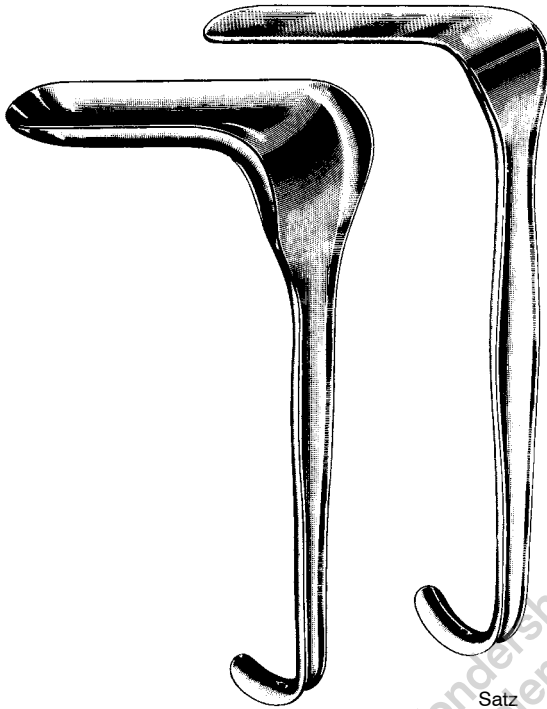


Fig. KRISTELLER mm
00 71241-00 110x18
0 71241-10 110x21
1 71241-01 110x27
2 71241-02 110x30
3 71241-03 110x36



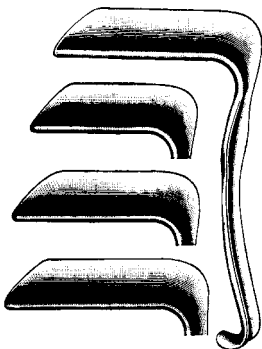
Fig. KRISTELLER mm
00 71242-00 115x14
0 71242-10 115x17
1 71242-01 115x23
2 71242-02 115x26
3 71242-03 115x32

Scheidenspekula
Vaginal Specula
Espéculos vaginales
Specoli vaginali



KALLMORGEN
71260-01 - 71262-02

Fig.	Satz Set Juego Serie	Spekula Speculum Espéculo Specolo	Halter Retractor Valva	mm	mm
1	71260-01	71261-01	70x40	71262-01	70x33
2	71260-02	71261-02	90x40	71262-02	90x33



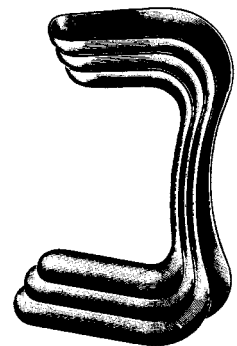
JACKSON

Fig.	mm
1	75x38
2	90x38
3	100x38



SIMS

Fig.	mm
1	63x32
2	76x32
3	89x38



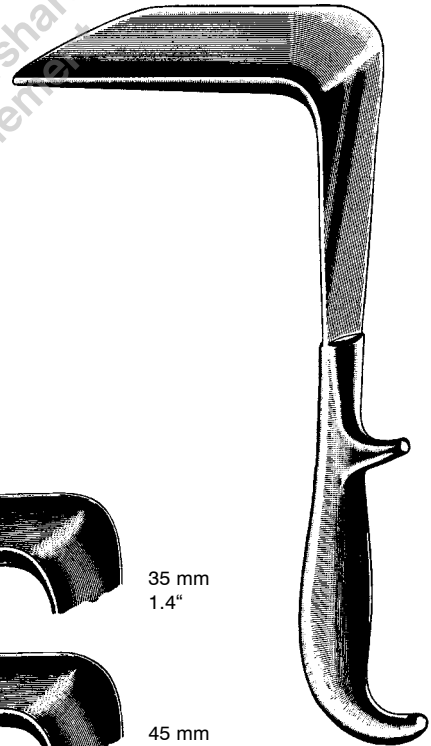
SIMS

Fig.	mm
1	60x25+30
2	70x30+35
3	80x35+40
Set	71291-00 (Fig. 1,2,3)

Scheidenspekula
Vaginal Specula
Espéculos vaginales
Specoli vaginali



DELEE
71300-01
23,5 cm, 9 1/4"



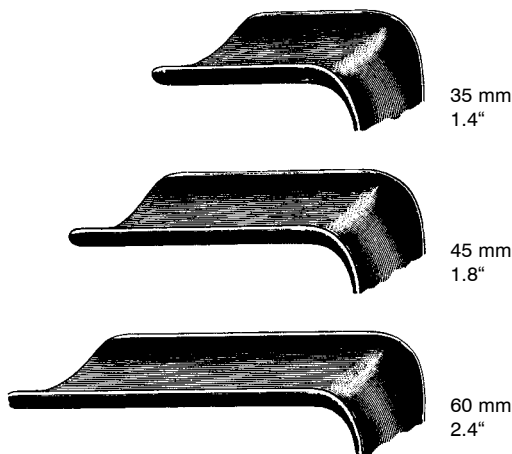
DOYEN
24 cm, 9 1/2"

leicht hohl
slightly concave
ligeramente concavos
leggermente concavi

Fig.		mm
1	71301-01	55x35
2	71301-02	85x35
3	71301-03	115x35

Fig.		mm
1	71303-01	55x45
2	71303-02	85x45
3	71303-03	115x45
4	71303-04	160x45
5	71303-05	180x45

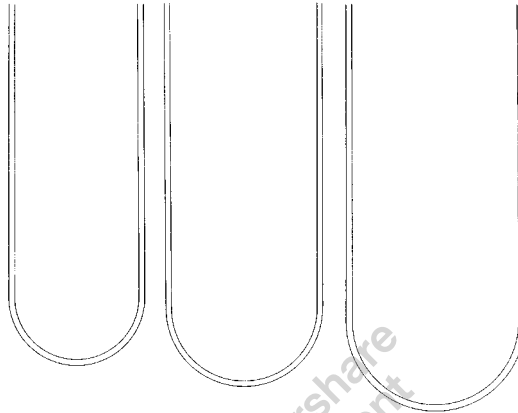
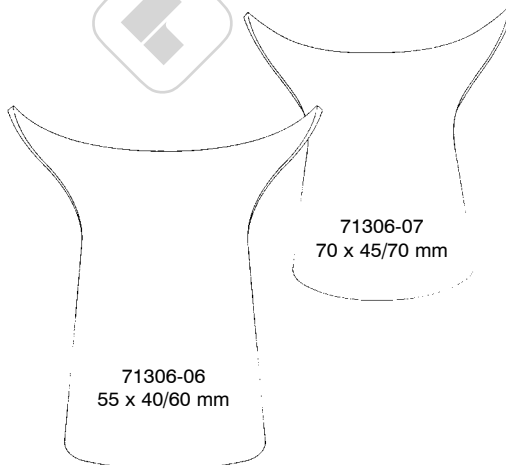
Fig.		mm
1	71305-01	55x60
2	71305-02	85x60
3	71305-03	115x60
4	71305-04	160x60
5	71305-05	180x60



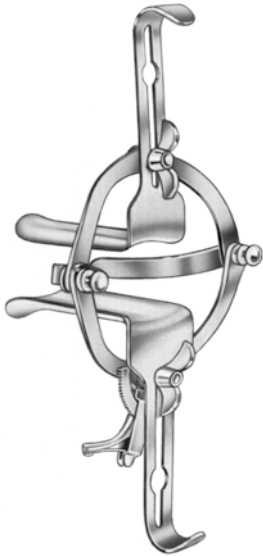
Scheidenspekula
Vaginal Specula
Espéculos vaginales
Specoli vaginali



71306-01 - 71306-03

71306-01
80 x 30 mm71306-02
85 x 35 mm71306-03
90 x 40 mm71306-04
Gewicht 400 gr
weight 400 grs
peso 400 grs
peso 400 grs71306-05
Gewicht 800 gr
weight 800 grs
peso 800 grs
peso 800 grs71306-06
55 x 40/60 mm71306-07
70 x 45/70 mmSCHERBAK
71306-00
Set komplett
complete set
juego completo
set completo71306-08
Griff, handle,
mango, manico

Scheidenspekula
Vaginal Specula
Espéculos vaginales
Specoli vaginali



O'SULLIVAN-O'CONNOR
71308-00



Fig. 1 = 45 x 17 mm 71308-01
Fig. 2 = 90 x 37 mm 71308-02
Fig. 3 = 90 x 45 mm 71308-03

71308-00

komplett bestehend aus:

1 Rahmen mit 2 beweglichen Seitenvalven
3 austauschbare Mittelvalven Fig. 1-3

1 frame with 2 mobile lateral blades
3 interchangeable blades Fig. 1-3

1 Marco con 2 separadores móviles laterales
3 separadores centrales intercambiables fig. 1-3

1 telaio regolabile con 2 valve laterali mobili
3 valve intercambiabili fig. 1-3

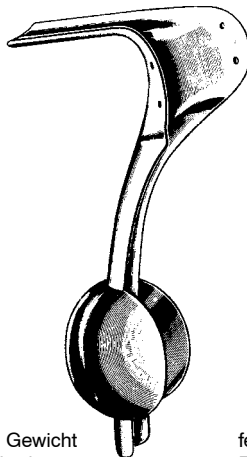
71308-04

Rahmen allein

Frame only

Marco solo

Telaio solo



abnehmbares Gewicht
Detachable Weight
Peso desmontable
Peso smontabile

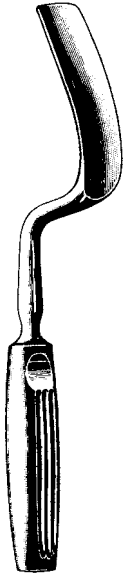
71307-00
1,4 kg
75 x 38 mm

AUVARD
24 cm, 9 1/2"

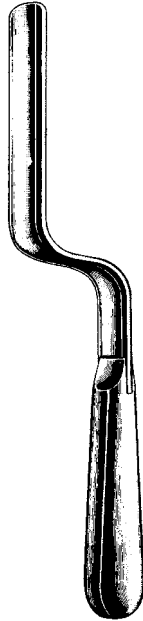
festes Gewicht
Fixed Weight
Peso fijo
Peso fisso

71309-00
1,4 kg
105 x 38 mm

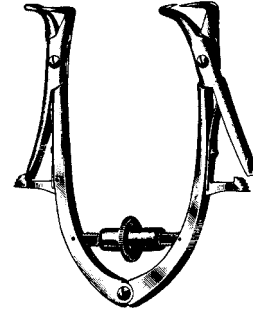
Scheidenspekula, Endospekula
Vaginal Specula, Endospekula
Especúlos vaginales, Endo-especúlos
Specoli vaginali, Endospecoli



mm	BREISKY	
100x20	71310-20	28 cm, 11"
100x25	71310-25	28 cm, 11"
100x30	71310-30	28 cm, 11"
100x35	71310-35	28 cm, 11"
100x40	71310-40	28 cm, 11"
130x20	71313-20	33 cm, 13"
130x25	71313-25	33 cm, 13"
130x30	71313-30	33 cm, 13"
130x35	71313-35	33 cm, 13"
130x40	71313-40	33 cm, 13"
155x40	71315-40	35 cm, 13 3/4"



mm	LANDAU	
100x28	71319-28	29 cm, 11 1/2"
100x38	71319-38	29 cm, 11 1/2"



	JOLL (FRIEDMANN)	
71351-10	10 cm, 4"	
71351-15	15 cm, 6"	

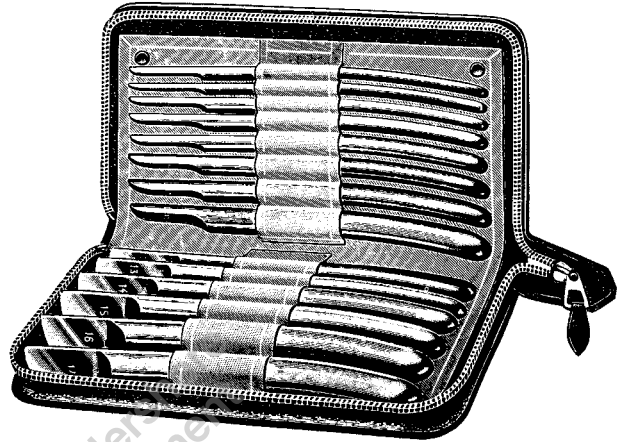


	KOGAN	
71360-24	3 mm	24 cm, 9 1/2"
71361-24	4 mm	24 cm, 9 1/2"
71362-24	5 mm	24 cm, 9 1/2"



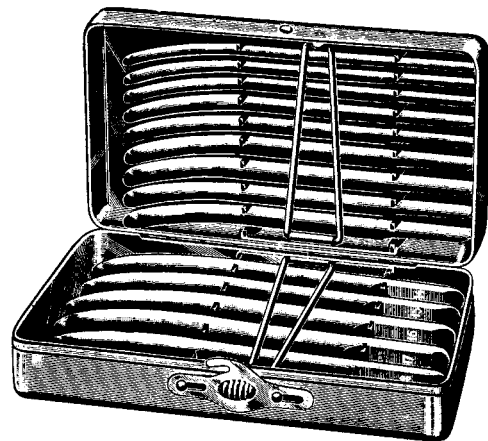
	KOGAN	
71363-24	3 mm	24 cm, 9 1/2"
71364-24	4 mm	24 cm, 9 1/2"
71365-24	5 mm	24 cm, 9 1/2"

Uterus Dilatatore
Uterine Dilators
Dilatadores uterinos
Dilatatori uterini



mm Ø	HEGAR		mm Ø
1	71410-01	71415-01	1,5
2	71410-02	71415-02	2,5
3	71410-03	71415-03	3,5
4	71410-04	71415-04	4,5
5	71410-05	71415-05	5,5
6	71410-06	71415-06	6,5
7	71410-07	71415-07	7,5
8	71410-08	71415-08	8,5
9	71410-09	71415-09	9,5
10	71410-10	71415-10	10,5
11	71410-11	71415-11	11,5
12	71410-12	71415-12	12,5
13	71410-13	71415-13	13,5
14	71410-14	71415-14	14,5
15	71410-15	71415-15	15,5
16	71410-16	71415-16	16,5
17	71410-17	71415-17	17,5
18	71410-18	71415-18	18,5
19	71410-19	71415-19	19,5
20	71410-20		
21	71410-21		
22	71410-22		
23	71410-23		
24	71410-24		
25	71410-25		
26	71410-26		
27	71410-27		
28	71410-28		
29	71410-29		
30	71410-30		

HEGAR
71405-14 4-17 mm
14 St./pces./pzas./pezzi



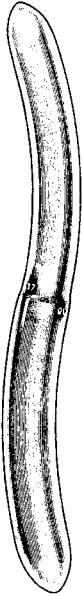
mm	HEGAR	
4-17	71406-14	14 St./pces./pzas./pezzi
1-26	71406-26	26 St./pces./pzas./pezzi

in Metalletui, in metal case,
en estuche de metal, in astuccio metallico

71404-14 Satz/Set/Juego/Set
71410-04 - 71410-17 = 14

71404-26 Satz/Set/Juego/Set
71410-01 - 71410-26 = 26

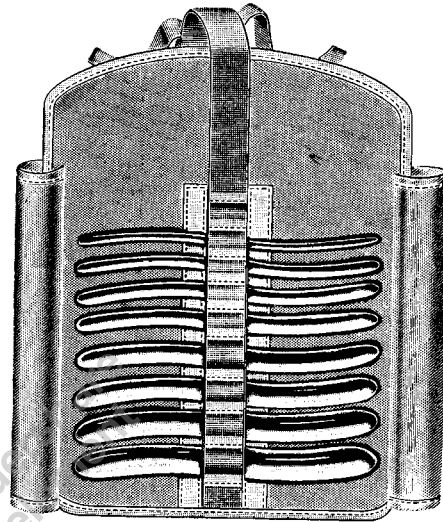
Uterus Dilatatoren
Uterine Dilators
Dilatadores uterinos
Dilatatori uterini



mm	HEGAR
1/ 2	71420-01
3/ 4	71420-03
5/ 6	71420-05
7/ 8	71420-07
9/10	71420-09
11/12	71420-11
13/14	71420-13
15/16	71420-15
17/18	71420-17
19/20	71420-19
21/22	71420-21
23/24	71420-23
25/26	71420-25

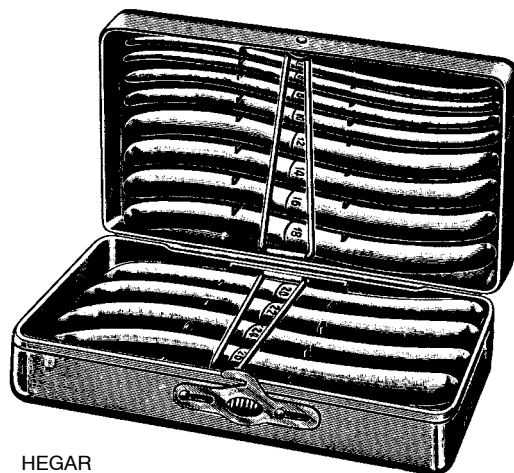
71424-08 Satz/Set/Juego/Set
71420-03 - 71420-17 = 8
3/4 - 17/18 mm

71424-13 Satz/Set/Juego/Set
71420-01 - 71420-25 = 13
1/2 - 25/26 mm



mm	HEGAR	
3/4 - 17/18	71425-08	8 St./pces./pzas./pezzi

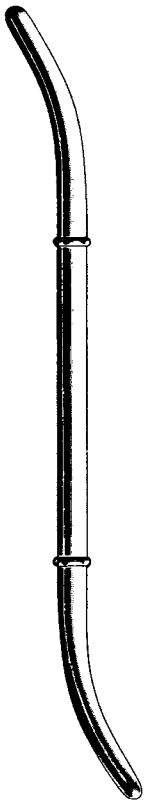
in Stofftasche, in khaki roll,
en bolsa de tela, in borsa di tela



mm	HEGAR	
3-4 - 17/18	71426-08	8 St./pces./pzas./pezzi
1/2 - 25/26	71426-13	13 St./pces./pzas./pezzi

in Metalletui, in metal case,
en estuche de metal, in astuccio metallico

Uterus Dilatatore
 Uterine Dilators
 Dilatadores uterinos
 Dilatatori uterini



in Stofftasche
 in khaki roll
 en bolsa de tela
 in borsa di tela

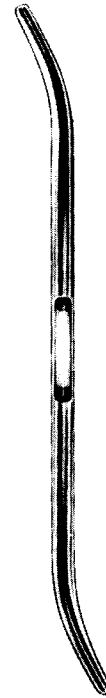
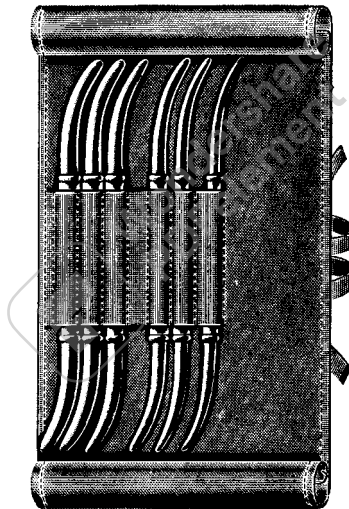


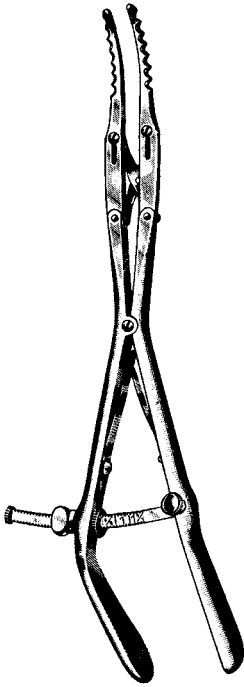
Fig.	mm/Ø	HANK
9/10	4,5/5	71430-10
11/12	5,5/6	71430-12
13/14	6,5/7	71430-14
15/16	7,5/8	71430-16
17/18	8,5/9	71430-18
19/20	9,5/10	71430-20

71436-06
 Satz, set, juego, serie = 6

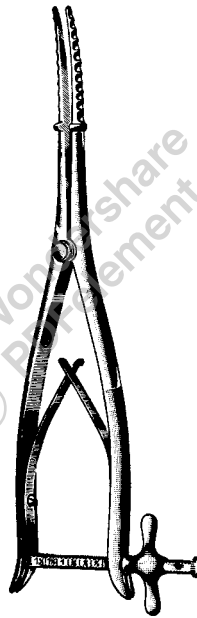
Fig./U.S.	mm/Ø	PRATT
13/15	4,5/5	71438-13
17/19	5,6/6,3	71438-17
21/23	7/7,6	71438-21
25/27	8,3/9	71438-25
29/31	9,6/10,3	71438-29
33/35	11/11,6	71438-33
37/39	12,3/13	71438-37
41/43	13,6/14,3	71438-41

71438-00
 Satz, set, juego, serie = 8

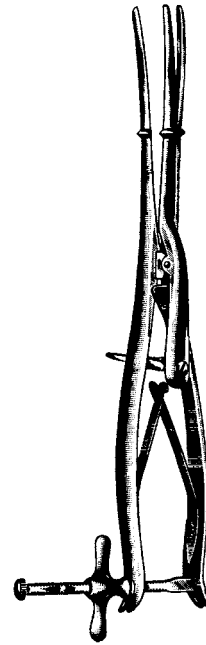
Uterus Dilatorem
Uterine Dilators
Dilatadores uterinos
Dilatatori uterini



GOODELL
71441-34
34 cm, 13 1/2"



WYLIE
71443-29
29 cm, 11 1/2"



SIMS
71445-29
29 cm, 11 1/2"

Hakenzangen

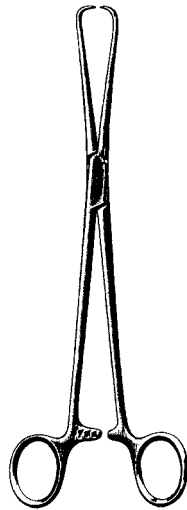
Tenaculum Forceps

Pinzas para coger el cuello del útero

Pinze per abbassare il collo dell'utero



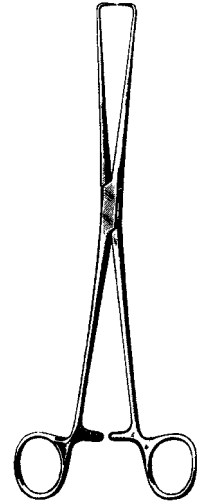
ADAIR
71500-18
19 cm, 7 1/2"



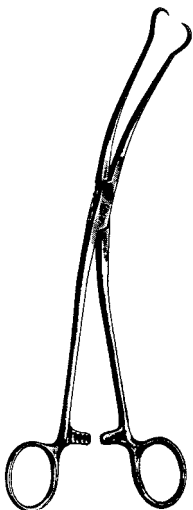
SCHRÖDER (POZZI)
71502-25
25 cm, 10"



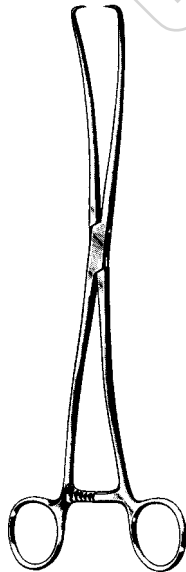
POZZI-PALMER
71503-25
25 cm, 10"



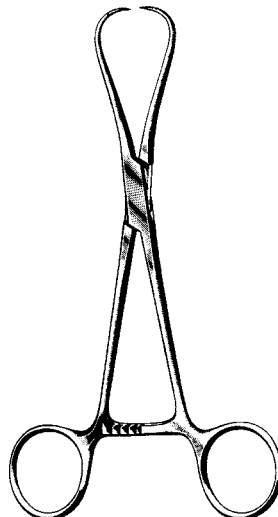
BRAUN
71504-25
25 cm, 10"



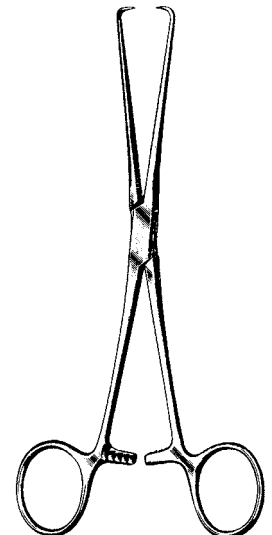
SKENE
71505-24
24 cm, 9 1/2"



DUPLAY
71507-28
28 cm, 11"

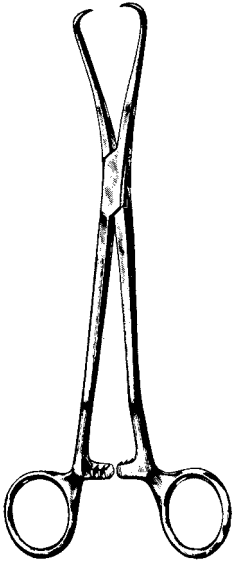


STAUDE-MOORE
71508-17
17 cm, 6 3/4"

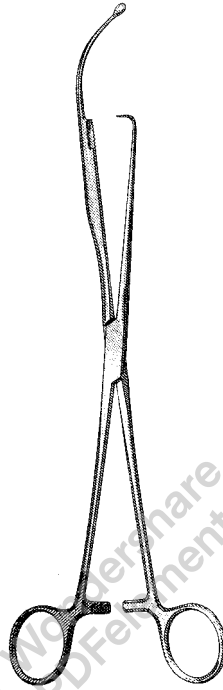


BARRETT
71510-18
18 cm, 7"

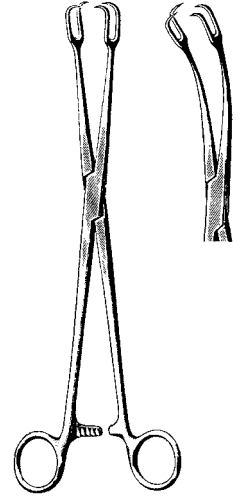
Hakenzangen
 Tenaculum Forceps, Vulsellum Forceps
 Pinzas para coger el cuello del útero
 Pinze per abbassare il collo dell'utero



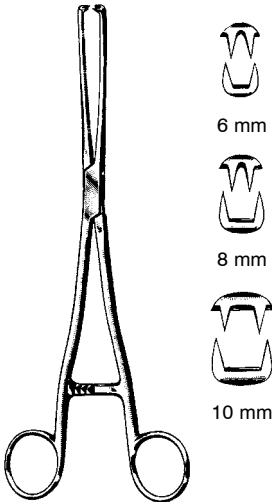
JARCHO
 71512-20
 20 cm, 8"



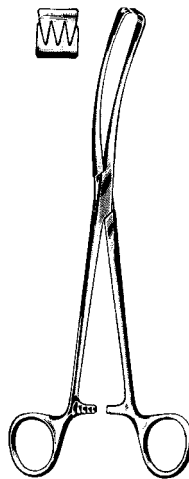
HULKA
 71512-28
 28 cm, 11"



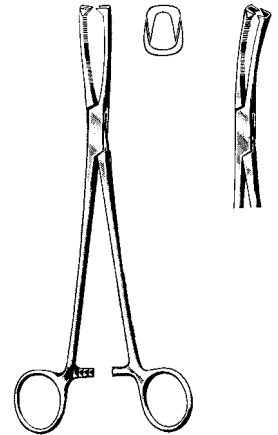
SCHRÖDER
 71514-24 71515-24
 24 cm, 9 1/2"



MUSEUX
 71524-06 6 mm 71525-06
 71524-08 8 mm 71525-08
 71524-10 10 mm 71525-10
 24 cm, 9 1/2"



TEALE
 71531-23
 23 cm, 9"



JACOBS
 71532-21 71533-21
 21 cm, 8 1/4"

Hakenzangen

Tenaculum Forceps, Vulsellum Forceps

Pinzas para coger el cuello del útero

Pinze per abbassare il collo dell'utero



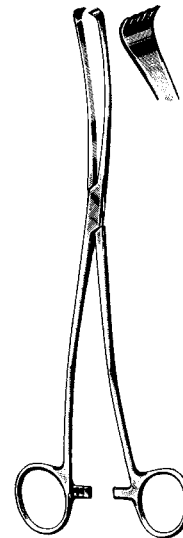
CZERNY
71536-21
20 cm, 8"



PRATT
71536-28
28 cm, 11"

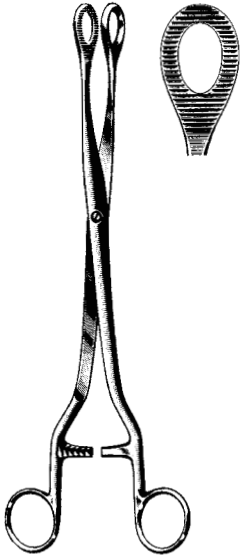


SCHRÖDER
71537-27
27 cm, 10 1/2"

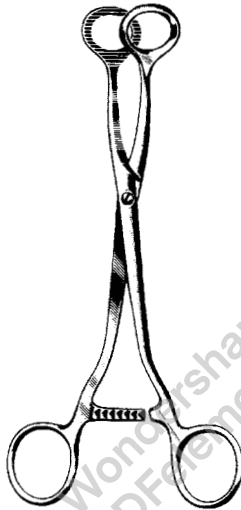


IOWA
71539-26
26 cm, 10 1/4"

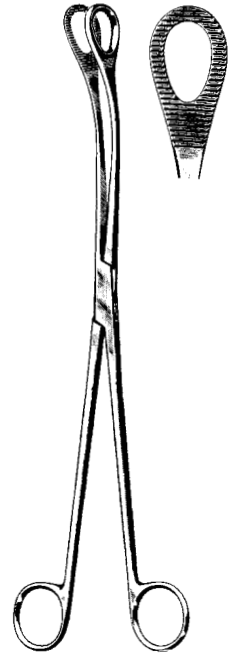
Uterus Polypenzangen, Uterus-Faßzangen
 Uterine Polypus Forceps, Uterine Elevating Forceps
 Pinzas para pólipos uterinos, Pinzas para el útero
 Pinze per polipi uterini, Pinze per afferrare l'utero



NOTO
 71540-27
 27 cm, 10 1/2"



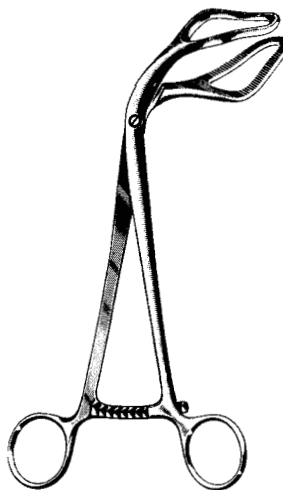
DOYEN
 71542-20
 20 cm, 8"



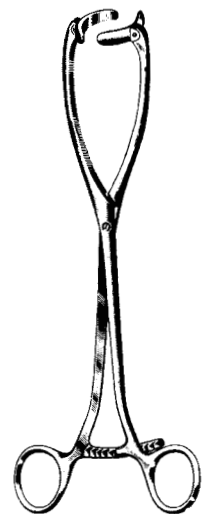
KELLY
 71543-32
 32 cm, 12 3/4"



DARTIGUES
 71545-27
 27 cm, 10 1/2"



SOMER
 71547-23
 23 cm, 9"



COLLIN
 71549-25
 25 cm, 10"

Amniotom, Uterus Depressoren, Uterus-Sonden
 Amniotome, Uterine Depressors, Uterine Sounds
 Amniótomo, Depresores uterinos, Histerómetros
 Amniotomo, Depressori uterini, Isterometri



BEACHAM
 71559-26
 26 cm, 10 1/4"



BRAUN
 71565-28
 28 cm, 11"



SIMS
 71567-26
 26 cm, 10 1/4"



fest
 rigid
 rigido
 rigida

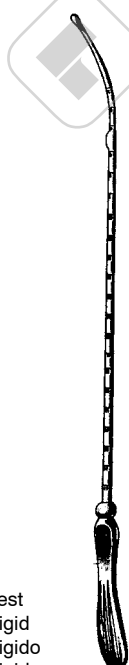
SIMS

71580-32

32 cm, 12 3/4"

biegsam
 malleable
 maleable
 malleabile

71581-32



fest
 rigid
 rigido
 rigida

MARTIN

71582-32

32 cm, 12 3/4"

biegsam
 malleable
 maleable
 malleabile

71583-32



COLLIN

71584-28

28 cm, 11"

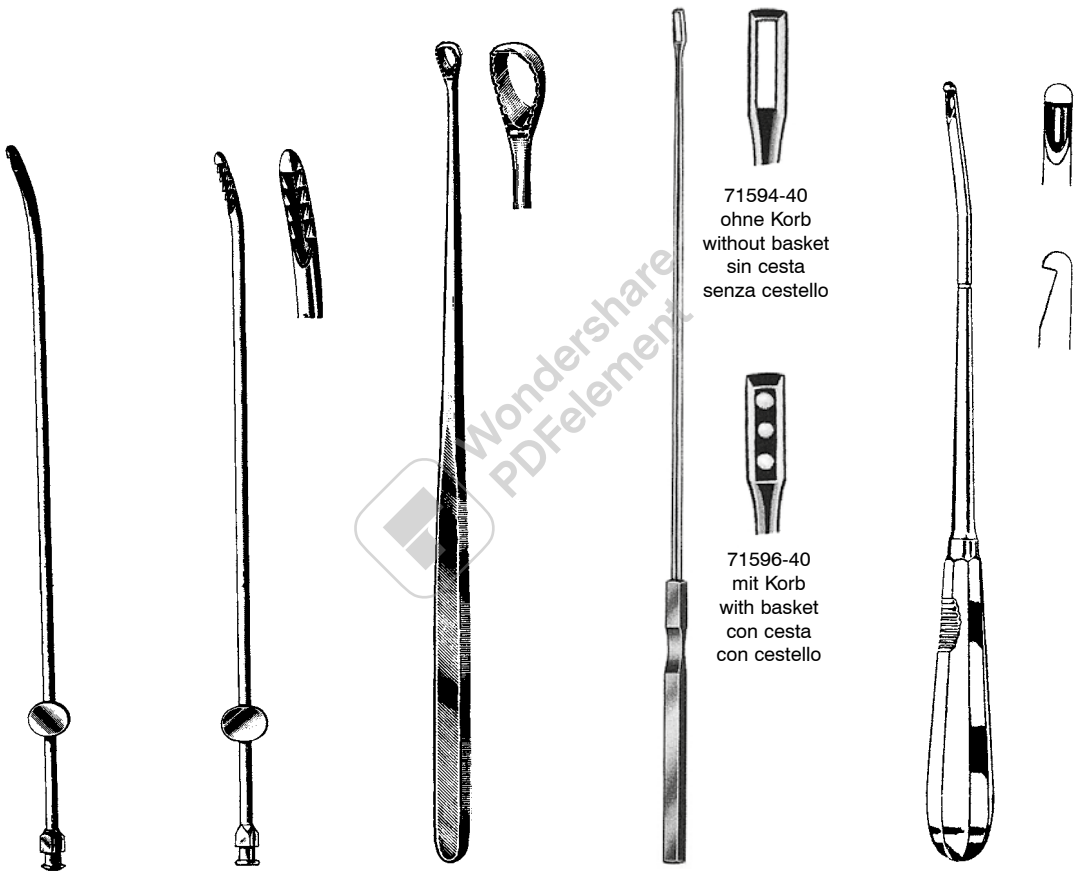


VALLEIX

71585-25

25 cm, 10"

Saugküretten, Biopsieküretten
Biopsy Curettes
Curetas para biopsia
Curette per biopsia



71594-40
ohne Korb
without basket
sin cesta
senza cestello

71596-40
mit Korb
with basket
con cesta
con cestello

RANDALL
71590-04
24 cm, 9 1/2"
Ø 4 mm

NOVAK
71592-01 Ø 1 mm
71592-02 Ø 2 mm
71592-03 Ø 3 mm
71592-04 Ø 4 mm

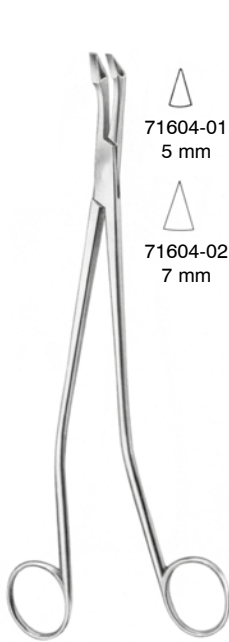
HEANY
71593-00
22,5 cm, 9"

KEVORKIAN
4,0 mm
30 cm, 11 3/4"

MOD. MUENCHEN
71598-27
27 cm, 10 1/2"

mit Luer-Lock Ansatz
with Luer-Lock connection
con conexión Luer-Lock
con raccordo Luer-Lock

Biopsiezangen
Biopsy Forceps
Pinzas para biopsia
Pinze taglienti per biopsia



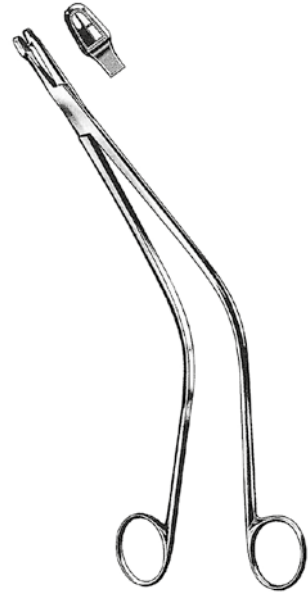
71604-01
5 mm

71604-02
7 mm

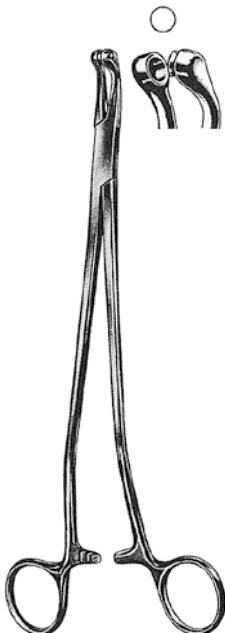
SCHUMACHER
24 cm, 9 1/2"



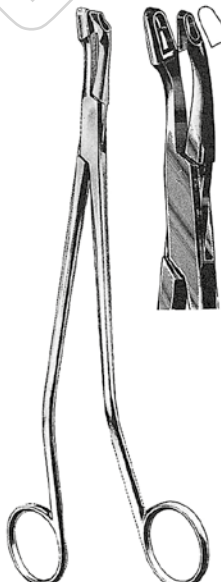
SCHUBERT
71604-21 21 cm, 8 1/4"
71604-28 28 cm, 11"



SCHUBERT
71605-26
26 cm, 10 1/4"



THOMS-GAYLOR
71606-24
24 cm, 9 1/2"

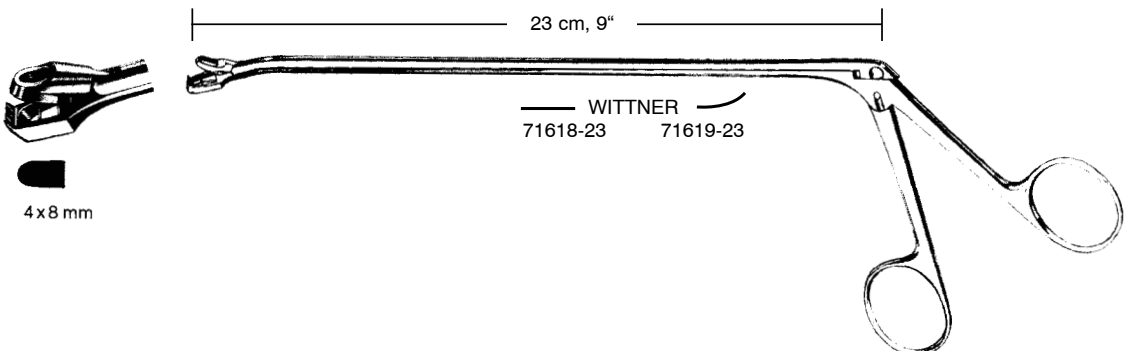
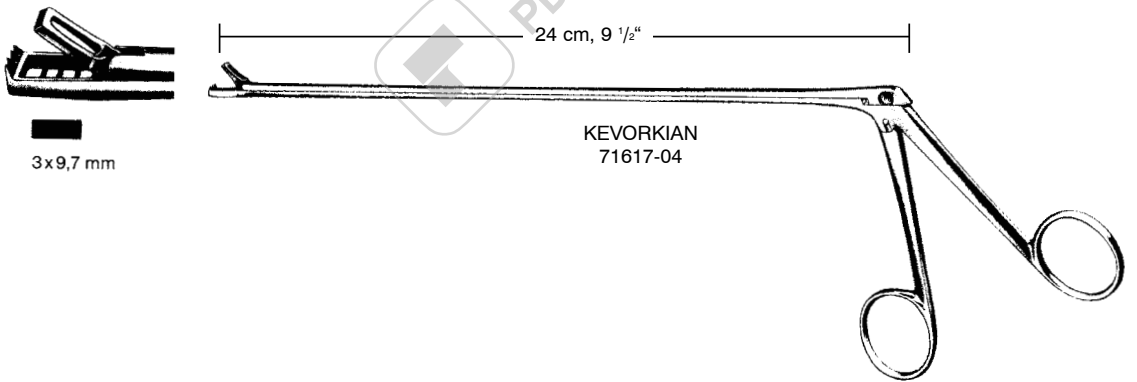
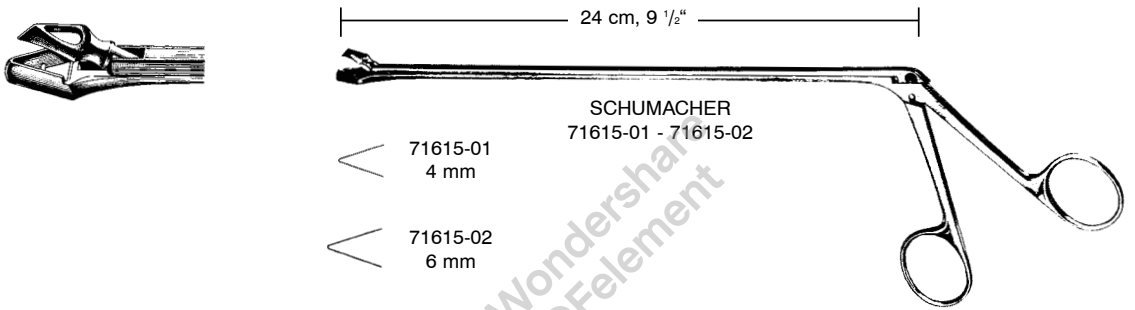
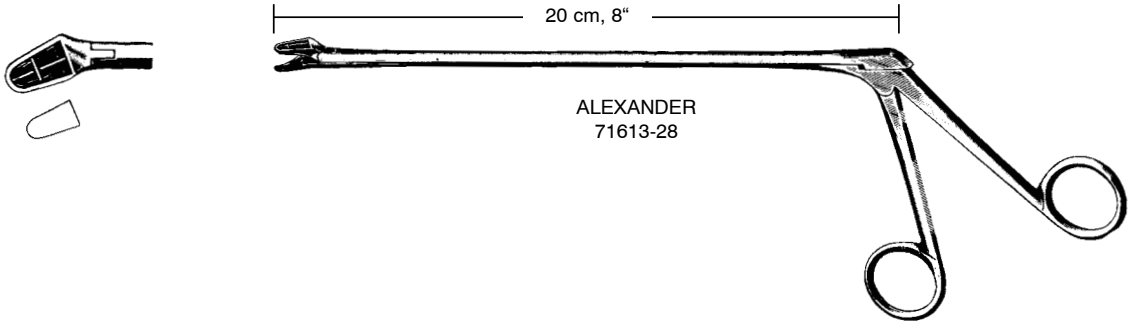


van DOREN
71611-25
25 cm, 10"

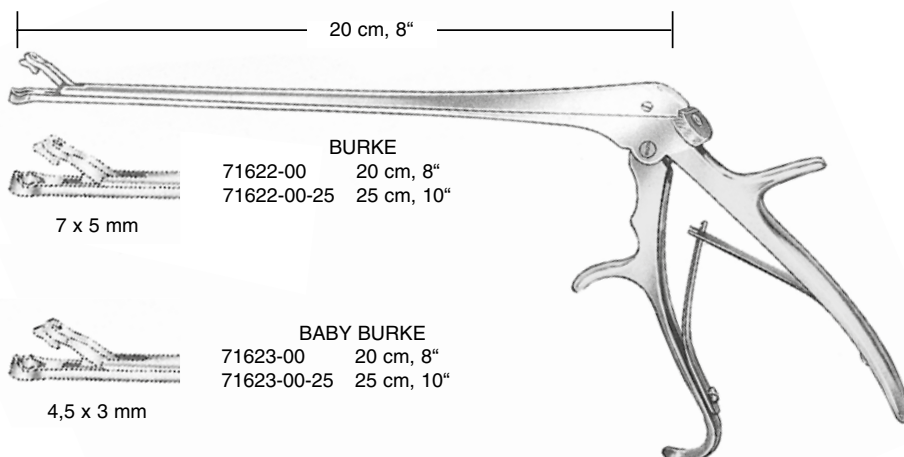
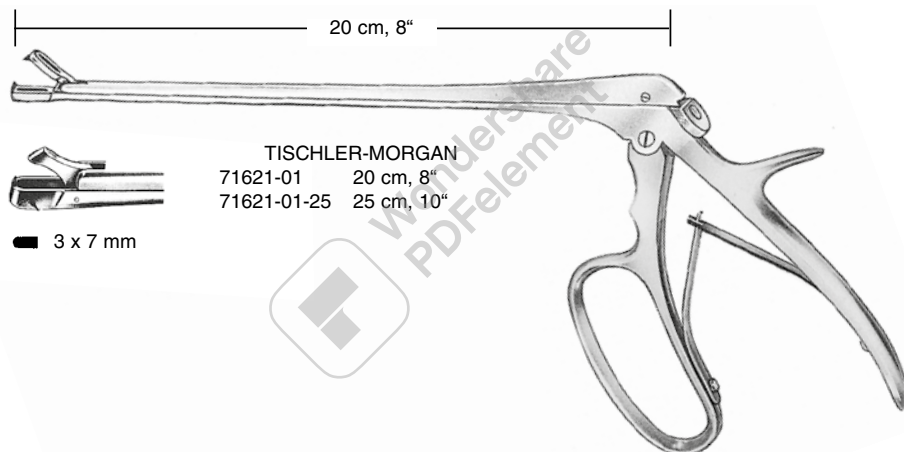
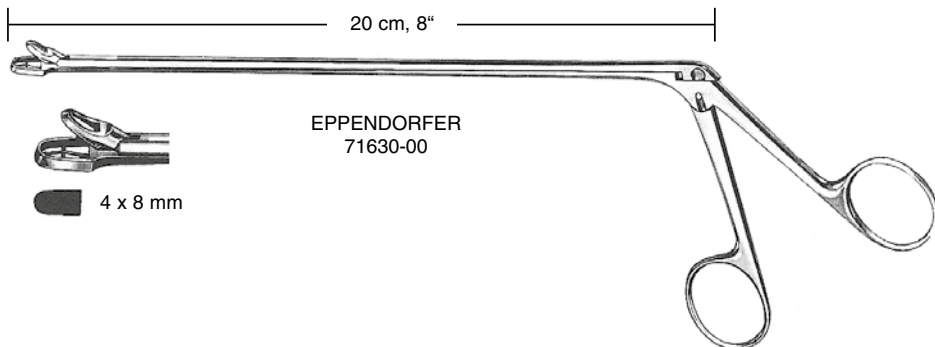


FAURE
71612-21
21 cm, 8 1/4"

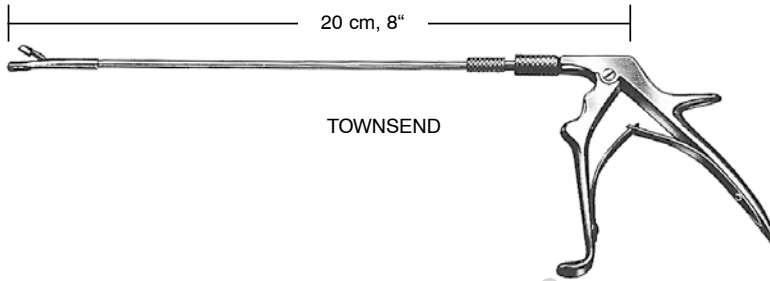
Uterus Biopsiezangen
 Biopsy Specimen Forceps
 Pinzas para biopsia
 Pinze per biopsia



Uterus Biopsiezangen
 Biopsy Specimen Forceps
 Pinzas sacabocado p. biopsia
 Pinze per biopsia



Uterus Biopsiezangen
Biopsy Specimen Forceps
Pinzas sacabocado p. biopsia
Pinze per biopsia



71624-10
Griff allein
Handle only
Mango solo
Manico solo



Fig. 1

TISCHLER-MORGAN



Fig. 6

TISCHLER-UP



Fig. 3

oval ● 3,7x5 mm



Fig. 7

TISCHLER-DOWN



Fig. 4

KEVORKIAN



Fig. 8

MINI-TOWNSEND-UP



Fig. 5

mini



Fig. 9

MINI-TOWNSEND-DOWN

Fig.	Strumento completo	Asta operativa sola
1	71624-01	71624-11
3	71624-03	71624-13
4	71624-04	71624-14
5	71624-05	71624-15
6	71624-06	71624-16
7	71624-07	71624-17
8	71624-08	71624-18
9	71624-09	71624-19

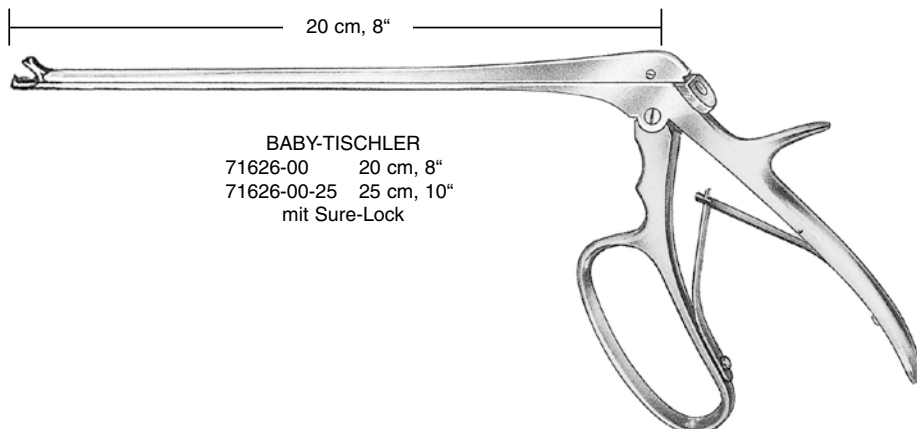
komplett
compl. instr.
Instrum. compl.

Aufsatz allein
Tip only
Punta sola

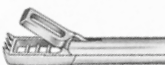
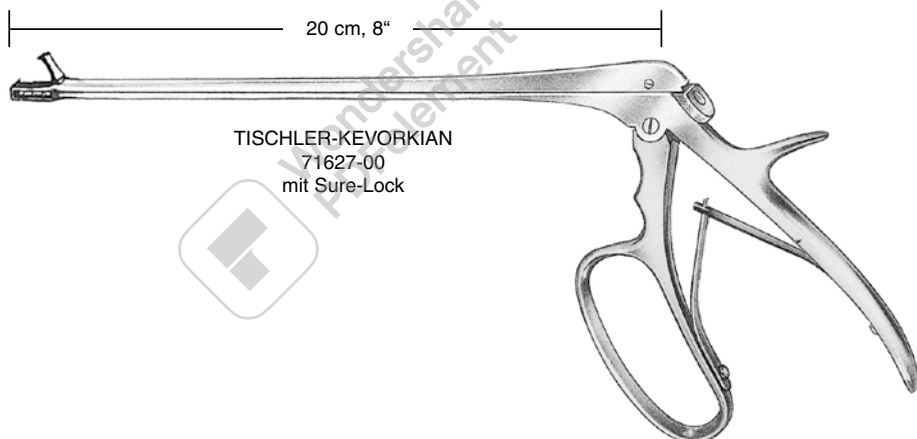
Uterus Biopsiezangen
 Biopsy Specimen Forceps
 Pinzas sacabocado p. biopsia
 Pinze per biopsia



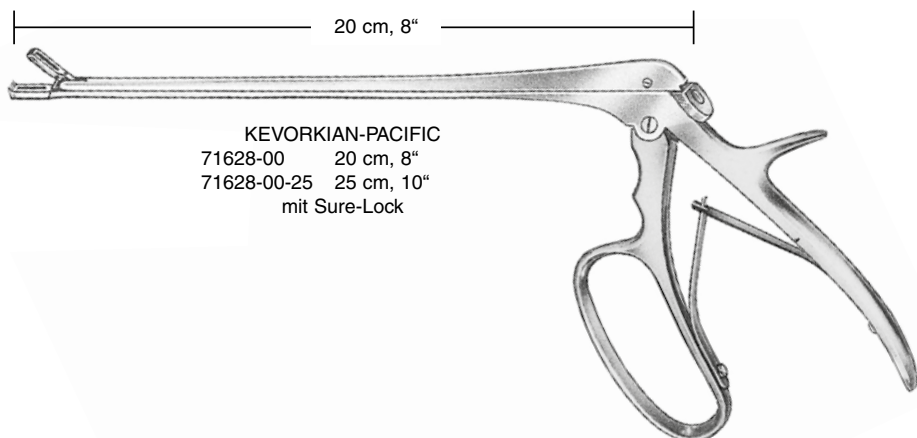
2,3 x 4,2 mm



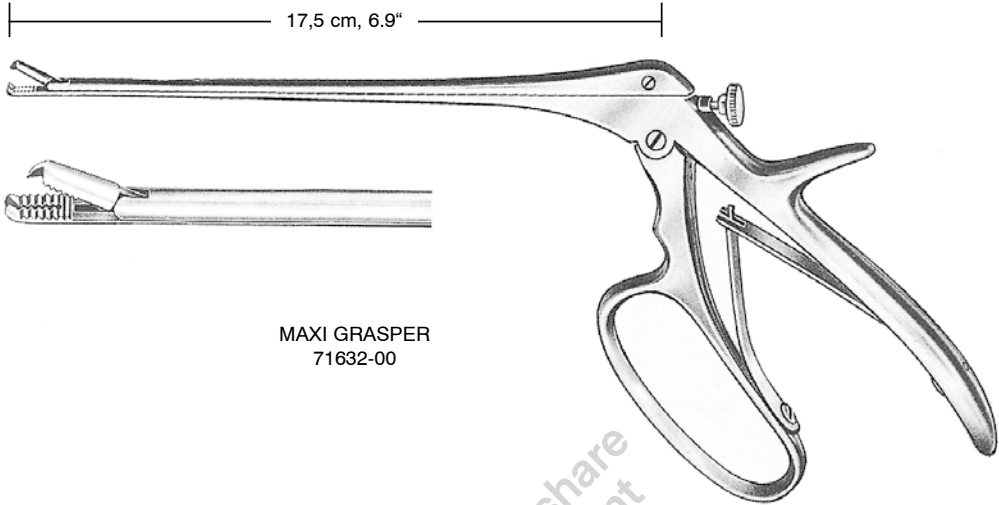
3 x 9,5 mm



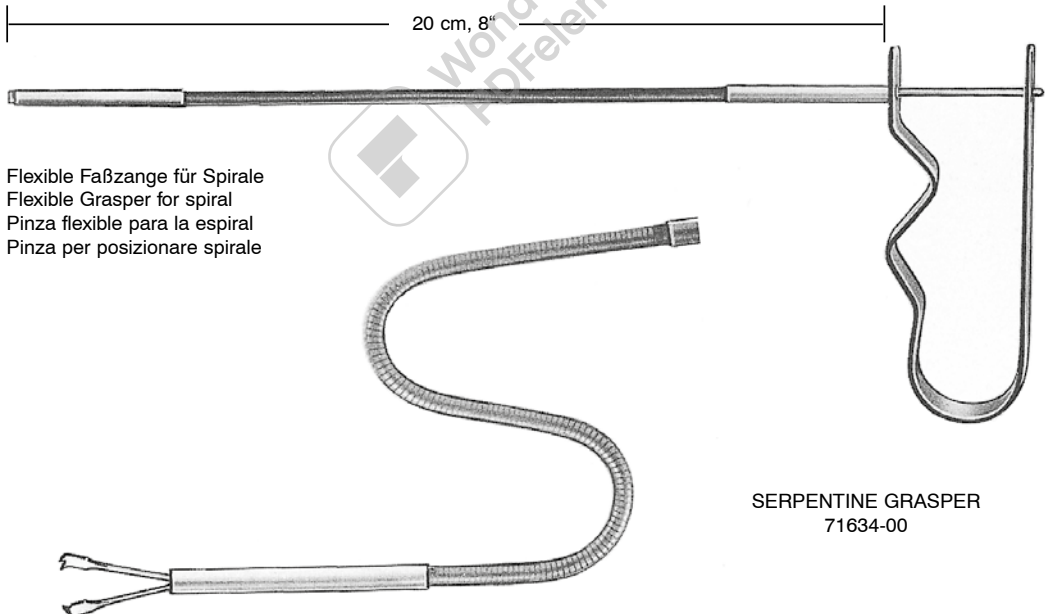
3 x 8 mm



Uterus Biopsiezangen
Biopsy Specimen Forceps
Pinzas sacabocado p. biopsia
Pinze per biopsia



MAXI GRASPER
71632-00



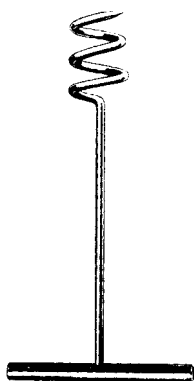
Flexible Faßzange für Spirale
Flexible Grasper for spiral
Pinza flexible para la espiral
Pinza per posizionare spirale

SERPENTINE GRASPER
71634-00

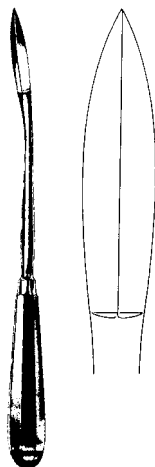


I.U.D.
Extractor Hook
71635-26
26 cm, 10 1/4"

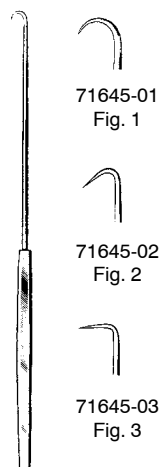
Myomheber, Myommesser, Fistelhäkchen, Meßinstrumente, Uteruslöffel
 Myoma Screw, Myoma Knife, Fistula Hook, Measuring Instruments, Uterine Curettes
 Tirabuzón para fibromas, Bisturi para fibromas, Ganchos para fistulas, Instrumental para medir, Curetas uterinas
 Tiramiomi, Bisturi per fibromi, Uncini per fistole, Strumenti per misure, Curette uterine



DOYEN
 71641-17
 17 cm, 6 3/4"



SEGOND
 71643-27
 27 cm, 10 1/2"



EMMET
 71645-01 - 71645-03
 22 cm, 8 3/4"

71645-01
 Fig. 1

71645-02
 Fig. 2

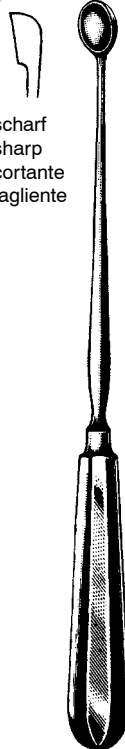
71645-03
 Fig. 3



71646-01



71646-02



scharf
 sharp
 cortante
 tagliente

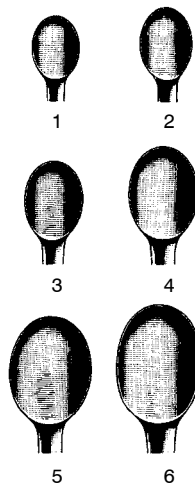


Fig. SIMON
 1 71702-01 6,8 mm
 2 71702-02 8,5 mm
 3 71702-03 10,0 mm
 4 71702-04 11,5 mm
 5 71702-05 13,0 mm
 6 71702-06 14,5 mm
 25 cm, 10"

Uterus-Küretten
 Uterine Curettes
 Curetas uterinas
 Curette uterine



SCHRÖDER
 31 cm, 12 1/4"



71703-01
 6,8 mm



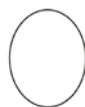
71703-02
 8,5 mm



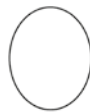
71703-03
 10 mm



71703-04
 11,5 mm

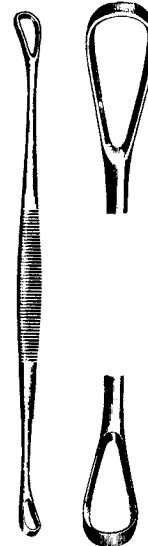


71703-05
 13 mm



71703-06
 14,5 mm

scharf/stumpf
 sharp/blunt
 cortante/roma
 tagliante/smussa



BLAKE
 71704-27
 27 cm, 10 1/2"

Salpingograph
Salpingograph
Salpingógrafo
Salpingografo

71650-00

SCHULTZE Salpingograph bestehend aus:

- 71650-01 1 Tubenkatheter
- 71650-02 1 Zwischenstück
- 71650-03 1 Manometer
- 71650-04 1 Kegel, klein
- 71650-05 1 Kegel, mittel
- 71650-06 1 Kegel, groß
- 71650-07 1 Recordspritze mit
Luer-Lock Ansatz 10cc

SCHULTZE salpinogograph compl.:

- 71650-01 1 Tubal catheter only
- 71650-02 1 connecting piece
- 71650-03 1 manometer
- 71650-04 1 cone small
- 71650-05 1 cone medium
- 71650-06 1 cone large
- 71650-07 1 syringe record
with Luer-Lock 10cc

Salpingógrafo compuesto de:

- 71650-01 1 cateter de tubo
- 71650-02 1 pieza de conexion
- 71650-03 1 manometro
- 71650-04 1 cono pequeño
- 71650-05 1 cono mediano
- 71650-06 1 cono grande
- 71650-07 1 jeringa con
conexión Luer-Lock 10cc

Salpingografo composto da:

- 71650-01 1 Catetere per tubo
- 71650-02 1 Raccordo
- 71650-03 1 Manometro
- 71650-04 1 Cono, piccolo
- 71650-05 1 Cono, medio
- 71650-06 1 Cono, grande
- 71650-07 1 Siringa record con
raccordo Luer-Lock 10cc

71660-00

Schultze Salpingograph, jedoch ohne
Manometer

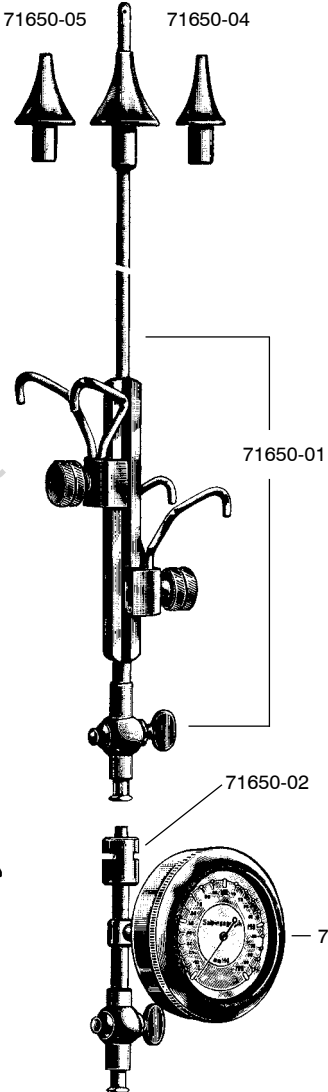
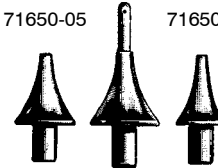
Schultze Salpingograph without
manometer

Schultze Salpingografo sin manometro

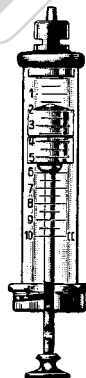
Schultze Salpingografo senza
manometro

71650-06

71650-05 71650-04



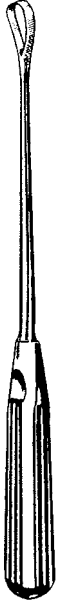
71650-07



SCHULTZE
71650-00
compl.

im Etui
in case
en estuche
in astuccio

Uterus-Küretten
Uterine Curettes
Curetas uterinas
Curette Uterine



SIMS

71710-05 - 71717-14
28 cm, 11"

	scharf sharp cort. tagl.	Fig.	mm	stumpf blunt roma smussa
fest	71710-05	00	5,0	71715-05
rig.	71710-06	0	6,0	71715-06
	71710-07	1	7,5	71715-07
	71710-08	2	8,5	71715-08
	71710-09	3	10,0	71715-09
	71710-11	4	11,5	71715-11
	71710-12	5	13,5	71715-12
	71710-14	6	14,5	71715-14

flexibel	71712-05	00	5,0	71717-05
flexible	71712-06	0	6,0	71717-06
fless.	71712-07	1	7,5	71717-07
	71712-08	2	8,5	71717-08
	71712-09	3	10,0	71717-09
	71712-11	4	11,5	71717-11
	71712-12	5	13,5	71717-12
	71712-14	6	14,5	71717-14



RECAMIER

71720-05 - 71727-20
31 cm, 12 1/4"

	scharf sharp cort. tagl.	Fig.	mm	stumpf blunt roma smussa
fest	71720-05	00	5	71725-05
rig.	71720-06	0	6	71725-06
	71720-07	1	7	71725-07
	71720-08	2	8	71725-08
	71720-09	3	9	71725-09
	71720-11	4	11	71725-11
	71720-12	5	12	71725-12
	71720-14	6	14	71725-14
	71720-15	7	15	71725-15
	71720-16	8	16	71725-16
	71720-19	9	19	71725-19
	71720-20	10	20	71725-20

flexibel	71722-05	00	5	71727-05
flexible	71722-06	0	6	71727-06
fless.	71722-07	1	7	71727-07
	71722-08	2	8	71727-08
	71722-09	3	9	71727-09
	71722-11	4	11	71727-11
	71722-12	5	12	71727-12
	71722-14	6	14	71727-14
	71722-15	7	15	71727-15
	71722-16	8	16	71727-16
	71722-19	9	19	71727-19
	71722-20	10	20	71727-20



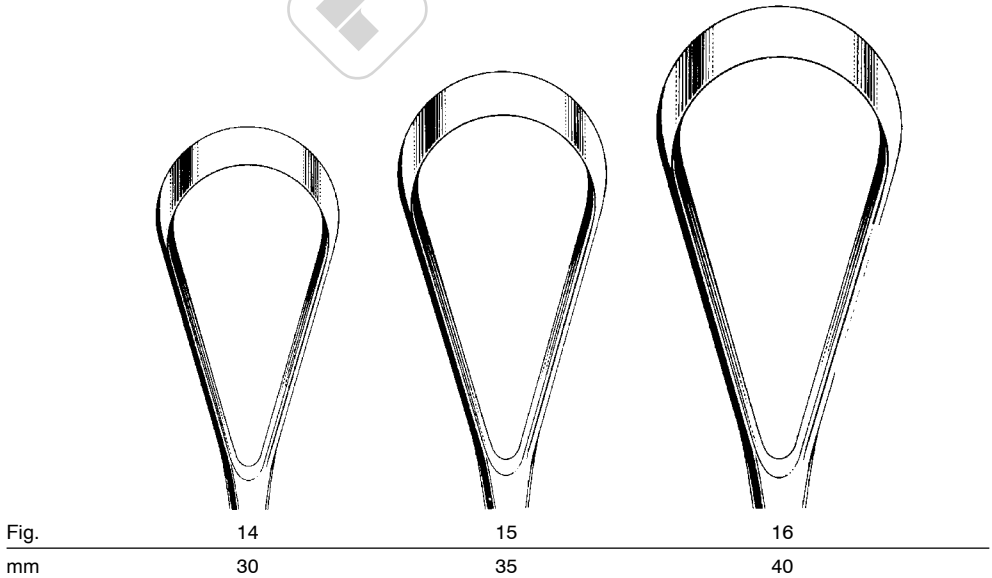
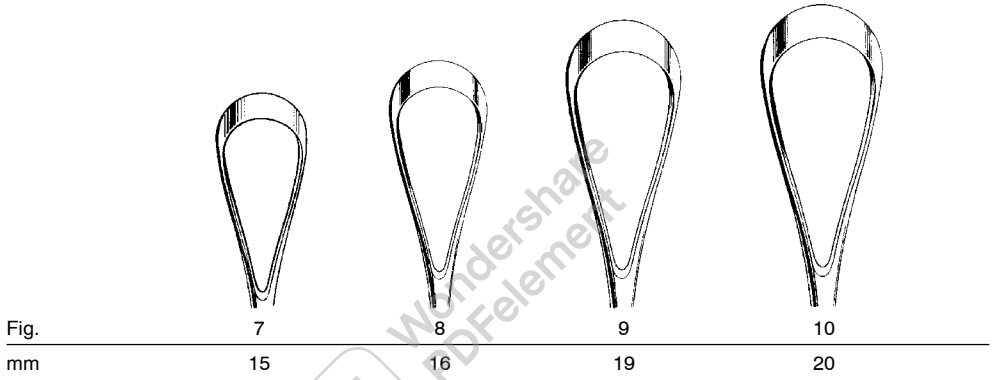
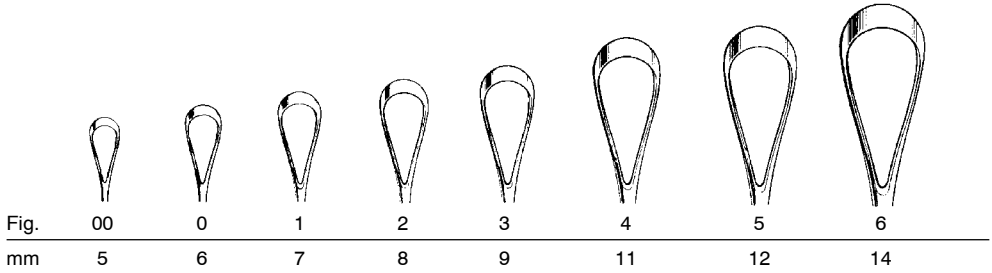
BUMM

71730-30 - 71737-40
35 cm, 13 3/4"

	scharf sharp cort. tagl.	Fig.	mm	stumpf blunt roma smussa
fest	71730-30	14		71735-30
rig.	71730-35	15		71735-35
	71730-40	16		71735-40

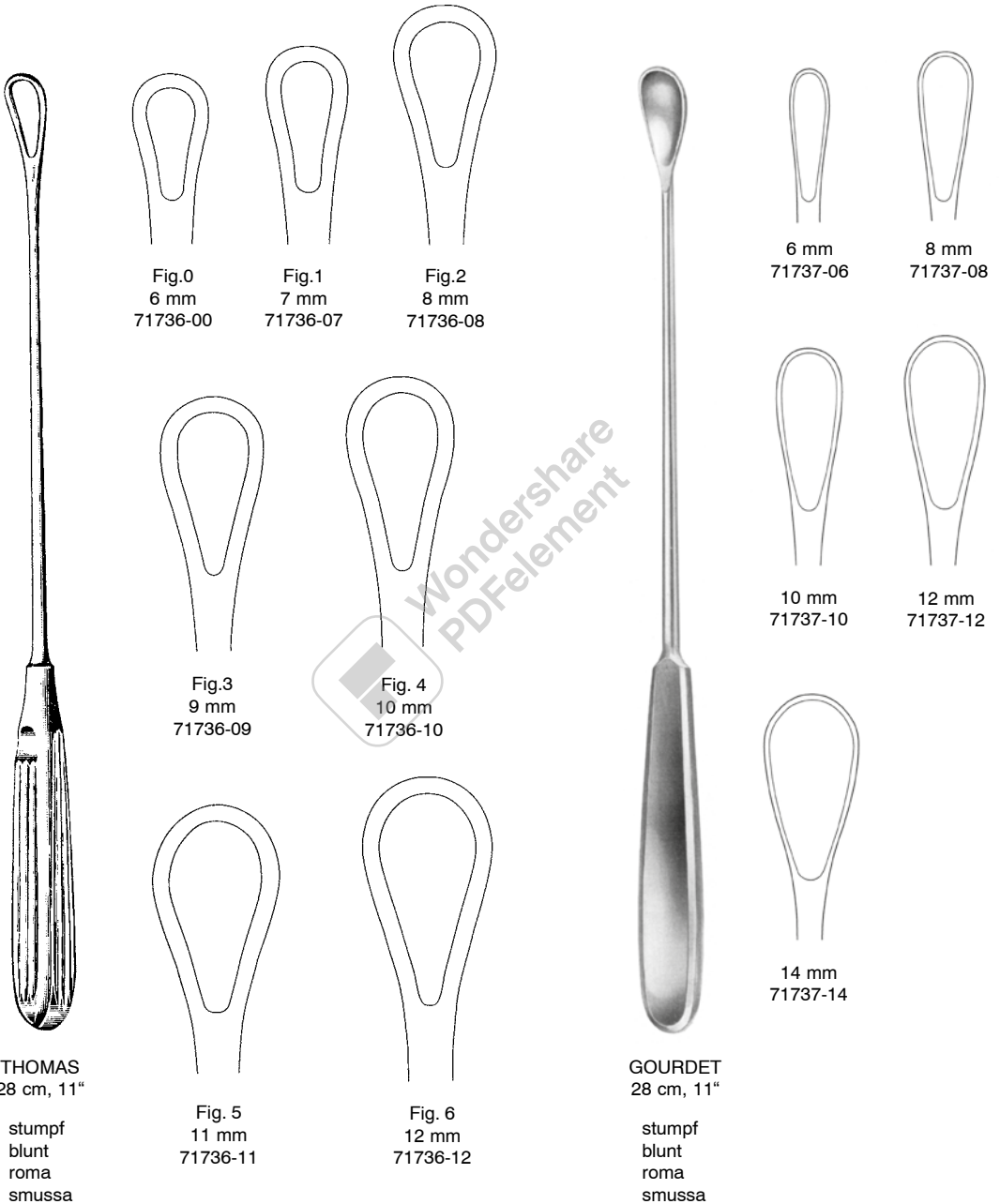
flexibel	71732-30	14		71737-30
flexible	71732-35	15		71737-35
fless.	71732-40	16		71737-40

Uterus-Küretten
 Uterine Curettes
 Curetas uterinas
 Curette uterine

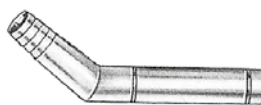


SIMS
 RECAMIER
 BUMM
 71710-05 - 71735-28

Uterus-Küretten
 Uterine Curettes
 Curetas uterinas
 Curette uterine



Biopsie- und Absaugküretten, Schlauch-Verbindungsstück
 Specimen and Aspirating Curettes, Hose connecting piece
 Curetas para biopsia y aspiración, Pieza conexión para tubos
 Curette di aspirazione per biopsia, Raccordo di connessione per tubi



71803-15

Amnioskope
Amnioscope
Amnioscopio
Amnioscopio

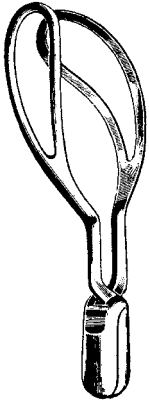


71810-12 12 x 24 mm Ø 20 cm, 8" lang
71810-16 16 x 24 mm Ø 20 cm, 8" lang
71810-20 20 x 24 mm Ø 20 cm, 8" lang



71810-50
Kaltlichtklammer
Cold Light clamp
Adaptador de iluminacion
Adattore di illuminazione

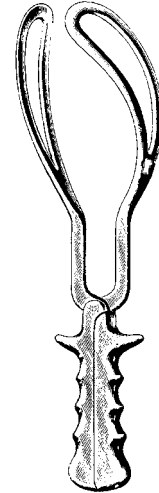
Geburtszangen
Obstetrical Forceps
Forceps obstétricos
Forcipi



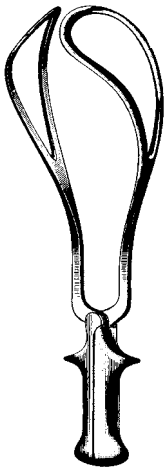
WRIGLEY
73101-23
23 cm, 9"



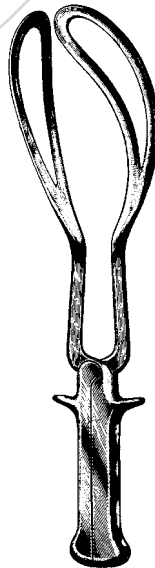
SIMPSON
73102-30
30 cm, 11 3/4"



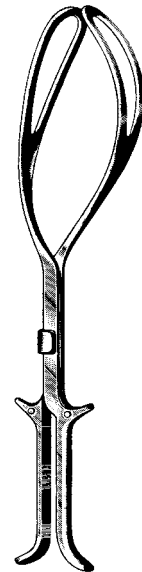
SIMPSON-BRAUN
73105-33 33 cm, 13"
73105-36 36 cm, 14"



De LEE
73107-30
30 cm, 11 3/4"

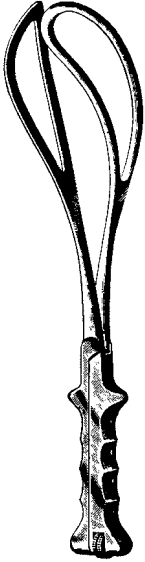


De LEE
73108-36 36 cm, 14"
73108-39 39 cm, 15 1/2"

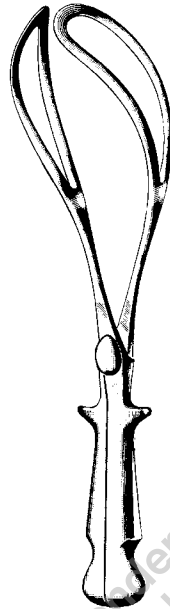


KIELLAND
73110-41
41 cm, 16"

Geburtszangen
Obstetrical Forceps
Forceps obstétricos
Forcipi



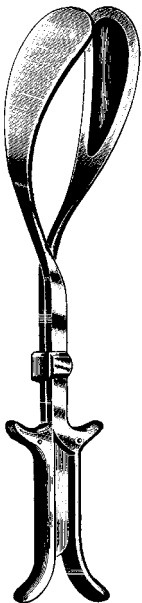
ELLIOT
73115-32 32 cm, 12 ³/₄"
73115-38 38 cm, 15"



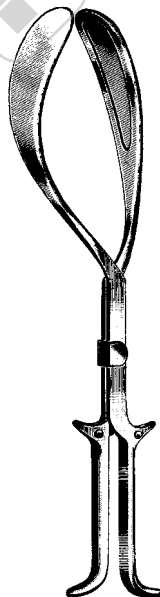
NAEGELE
73119-36 36 cm, 14"
73119-40 40 cm, 15 ³/₄"



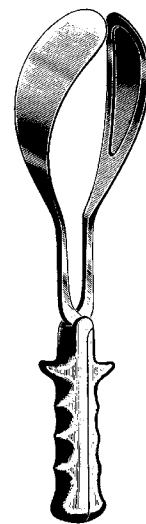
THIERRY
73123-39 39 cm, 15 ¹/₂"



LUIKART
73125-40
40 cm, 15 ³/₄"

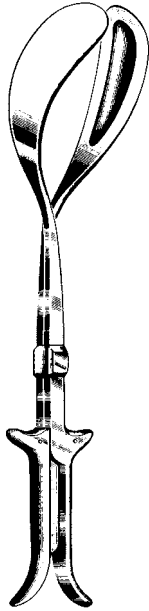


KIELLAND-LUIKART
73127-40
40 cm, 15 ³/₄"

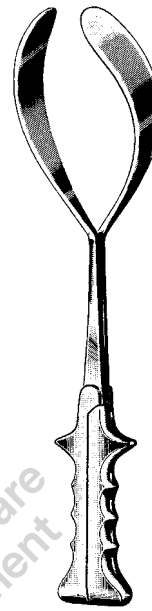


SIMPSON-LUIKART
73135-36
36 cm, 14"

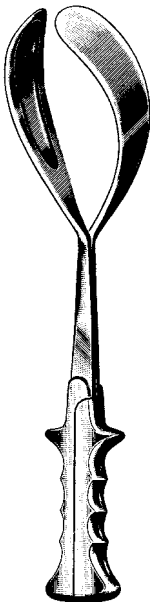
Geburtszangen
Obstetrical Forceps
Forceps obstétricos
Forcipi



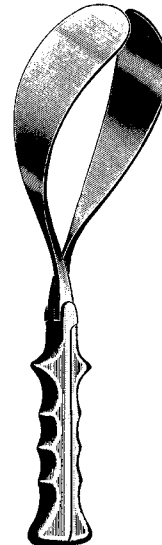
McLEAN-TUCKER-LUIKART
73139-40
40 cm, 15 ³/₄"



McLEAN-TUCKER
73141-39
39 cm, 15 ¹/₂"

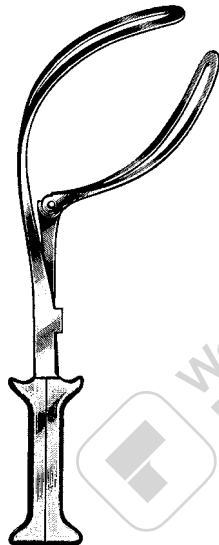


McLEAN-LUIKART
73143-39
39 cm, 15 ¹/₂"

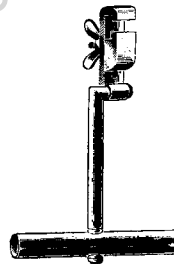


McLEAN
73145-36
36 cm, 14"

Geburtszangen, Zughebel
Obstetrical Forceps, Traction Handle
Forceps obstétricos, Dispositivos de tracción
Forcipi, Leve per trazione

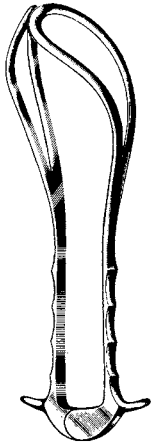


BARTON
73147-36
36 cm, 14"

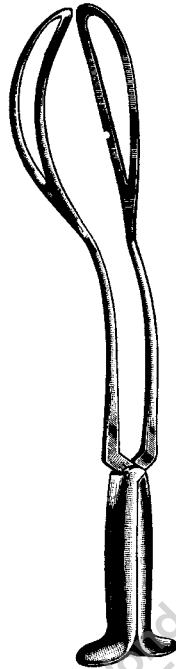


BARTON
73148-17
17 cm, 6 3/4"

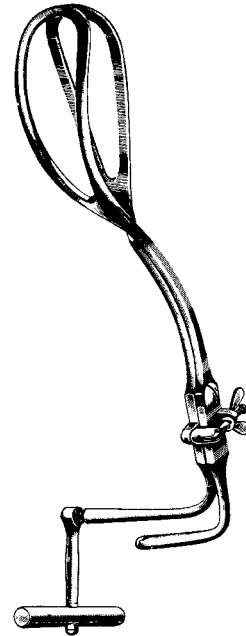
Geburtszangen, Zughebel
 Obstetrical Forceps, Traction handles
 Forceps obstétricos, Dispositivos de tracción
 Forcipi, Leve per trazione



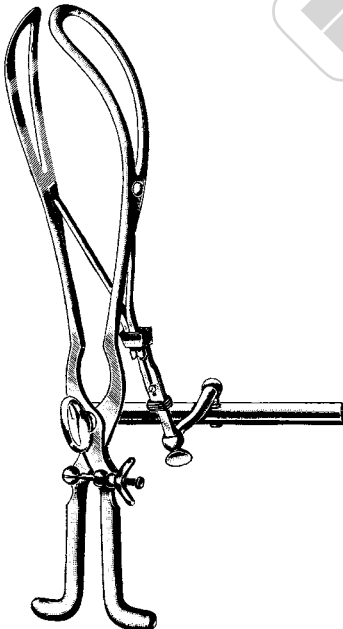
BOERMA
 73151-29
 29 cm, 11 1/2"



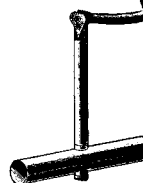
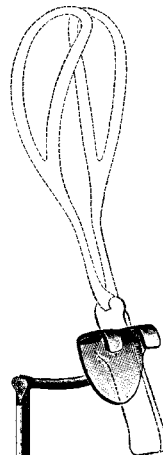
PIPER
 73155-44
 44 cm, 17 1/4"



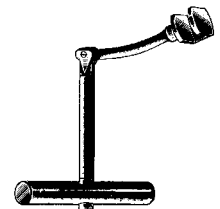
PIPER
 73157-40
 40 cm, 15 3/4"



TARNIER
 73162-40
 40 cm, 15 3/4"



BILL
 73170-00
 21 cm, 8 1/4"

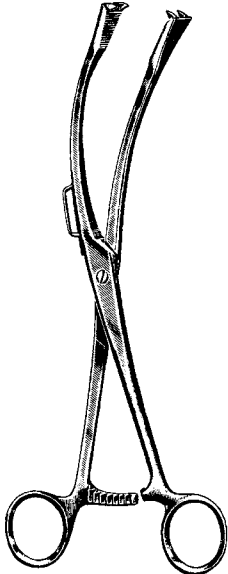


LUIKART-BILL
 73171-21
 21 cm, 8 1/4"

Geburtshaken, Kopfschwartzangen, Uterus-Klemmzange, Nabelschnurklemmen, Beckenzirkel
 Scalp flap forceps, Uterine haemostatic forceps, Umbilical cord clamps, Pelvimeters
 Pinzas para cuero cabelludo, Pinzas-clamps uterinas para hemóstasis, Clamp umbilical, Pelvímetros
 Pinza per il cuoio capelluto, Pinza uterina, Pinza ombelicale, Pelvimetri



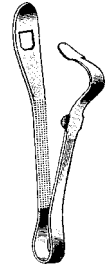
SMELLIE
73181-33
33 cm, 13"



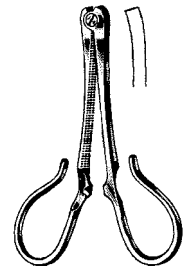
GAUSS
73183-27
27 cm, 10 1/2"



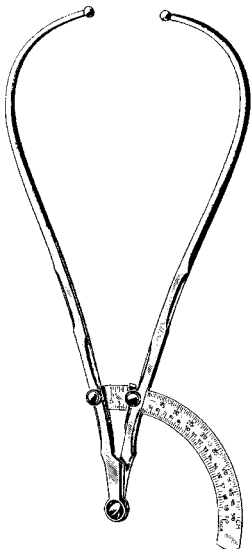
GREEN-ARMYTAGE
73184-21
21 cm, 8 1/4"



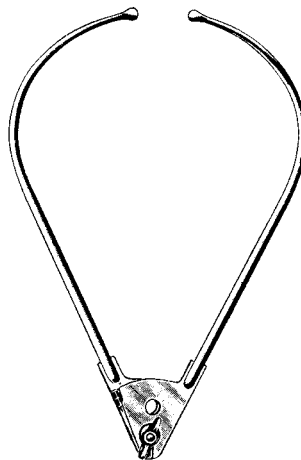
COLLIN
73187-09
9 cm, 3 1/2"



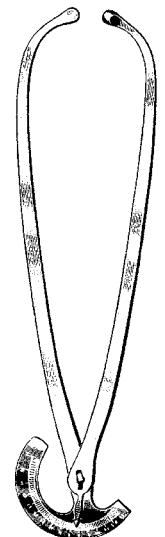
KANE
73189-09
8,5 cm, 3 1/4"



MARTIN
73191-34
34 cm, 13 1/2"

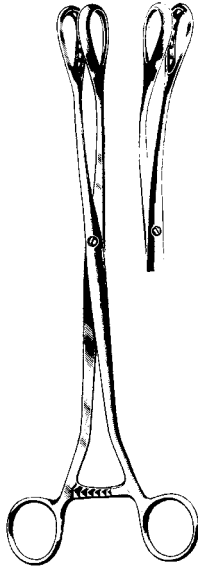


COLLIER
73193-30
30 cm, 11 3/4"

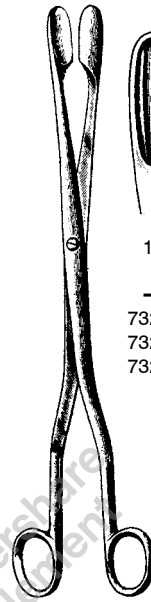


COLLIN
73195-35
35 cm, 14"

Abortuszangen, Abortuslöffel
 Ovum Forceps, Abortion Scoops
 Pinzas para aborto, Cucharillas para aborto
 Ostetricia, Curette per aborto

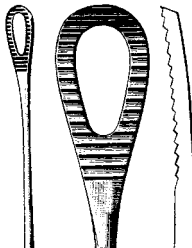


SAENGER
 73242-27 73243-27
 27 cm, 10 1/2"



WINTER
 73244-01 - 73245-03
 28 cm, 11"

	1	2	3
Fig.	1	2	3
	73245-01	73245-02	73245-03



PESTALOZZA
 73252-30
 30 cm, 11 3/4"



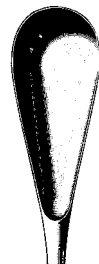
CUZZI
 73254-14 - 73254-21
 30 cm, 11 3/4"



73254-14
 14,5 mm



73254-18
 18 mm



73254-21
 21 mm

Abortuslöffel, Geburtslöffel, Kranioklast, Basiotrip, Perforatorium, Dekapitationshaken
 Abortion Scoops, Elevating Spoon, Cranioclast, Basiotribe, Perforators, Decapitating hook
 Cucharillas para aborto, Separador obstetrico, Craneoclasto, Basiotribo, Perforacráneos, Gancho para decapitación
 Curette per aborto, Cucchiaino Ostetrico, cranioclasto, Basiotribo, spezzacrani, Uncino per decapitazione



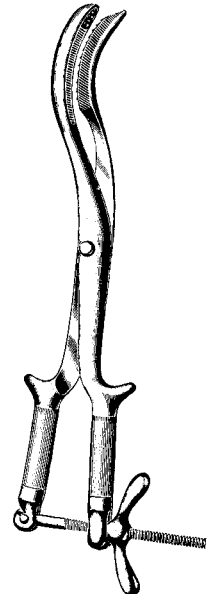
stumpf
blunt
roma
smussa



WALLICH
73256-42
42 cm, 16 1/2"



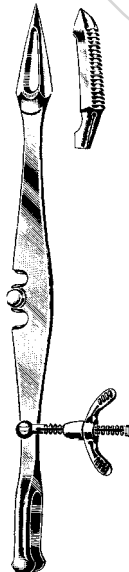
SELLHEIM
73259-28
28 cm, 11"



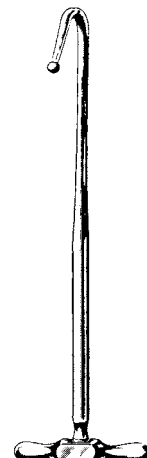
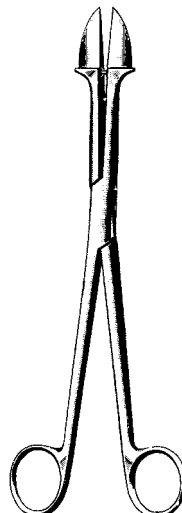
BRAUN
73302-42
42 cm, 16 1/2"



TARNIER
73304-46
46 cm, 18"



SMELLIE
73306-25
25 cm, 10"



BRAUN
73309-30
30 cm, 11 3/4"

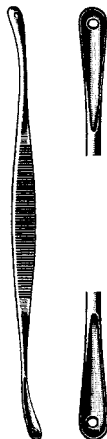
Hauthäkchen, Komedonenquetscher, Lupusküretten, Hautküretten, Haut-Trephinen
 Skin hooks, Comedone extractors, Lupus curettes, Skin curettes, Cutaneous punches
 Ganchos cutáneos, Sacaca comedones, Curetas para lupus, Curetas cutáneas, Trépanos cutáneos
 Uncini cutanei, Schiaccia comedoni, Curette per lupus, Curette cutanee, Trefine cutanee



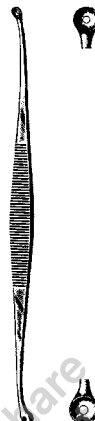
KILNER
75103-15
15 cm, 6"



SCHAMBERG
75111-10
10 cm, 4"



UNNA
75113-14
14 cm, 5 1/2"



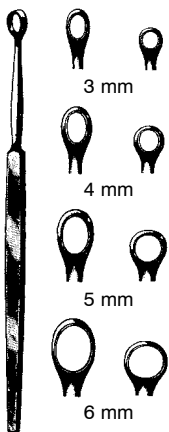
UNNA
75115-14
14 cm, 5 1/2"



WALTON
75118-14
14 cm, 5 1/2"



SAALFELD
75121-10
10 cm, 4"



14 cm, 5 1/2"

FOX		FOX	
75128-01	1 mm	75129-01	1 mm
75128-02	2 mm	75129-02	2 mm
75128-03	3 mm	75129-03	3 mm
75128-04	4 mm	75129-04	4 mm
75128-05	5 mm	75129-05	5 mm
75128-06	6 mm	75129-06	6 mm



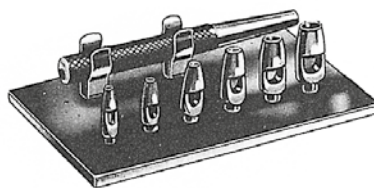
PIFFARD
14,5 cm, 5 3/4"

75130-01	Fig. 1
75130-02	Fig. 2
75130-03	Fig. 3

Fig. 1

Fig. 2

Fig. 3



75138-00

Satz komplett mit 6 Aufsätzen
 Set complete with 6 tips
 Juego con 6 puntas
 Serie completa con 6 trefini



KEYES
10 cm, 4"

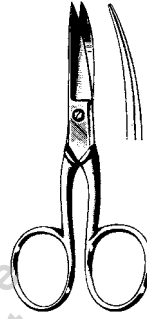
75140-02	2 mm
75140-03	3 mm
75140-04	4 mm
75140-05	5 mm
75140-06	6 mm
75140-07	7 mm
75140-08	8 mm

- 2 mm
- 3 mm
- 4 mm
- 5 mm
- 6 mm
- 7 mm
- 8 mm

Nagelzangen, -Scheren
Nail Nippers, Scissors
Alicates corta-uñas
Tronchesini forbici per unghie



75301-10



75304-10 10 cm, 4" 75305-10



75331-14
14 cm, 5 1/2"
stainless

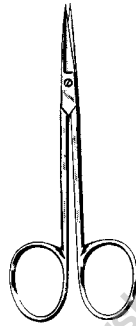


TURNBULL
75341-11 11,5 cm, 4 1/2"
75341-13 13,5 cm, 5 1/4"
stainless

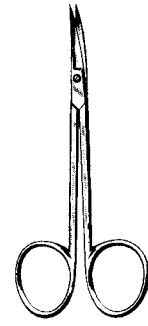
Nagelhautzangen, Hautscheren, Nagelfeilen
Cuticle Nippers, Cuticle Scissors, Nail Files
Pinzas y Tijeras cuticulares, Limas para uñas
Tronchesine per unghie e pelle, Limette per le unghie



75373-10
10,5 cm, 4"



75378-10
10 cm, 4"

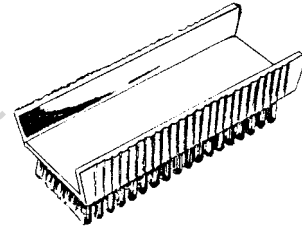
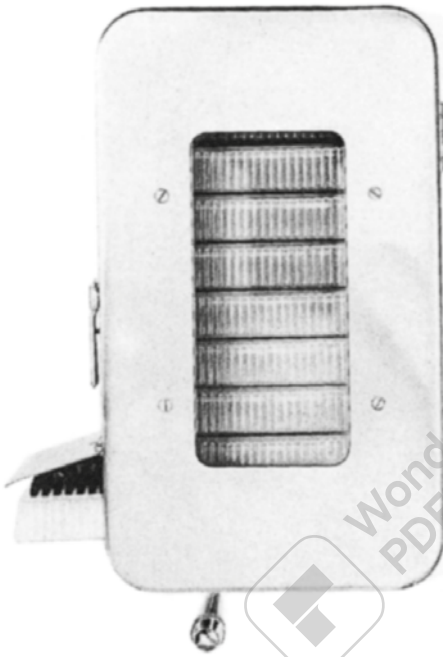


75379-10
10 cm, 4"



75382-16

Bürstenspender, Handwaschbürsten
Brush Dispensor, Nail brushes
Dispensador de cepillos, Cepillo para uñas
Distributore di spazzole, Spazzole per unghie



75397-00

Pack. à 10 St.
Box of 10 pcs
caja de 10 pzas.
confezione da 10 pezzi

75396-01
Bürstenspender für 10 Bürsten
Brush dispensor for 10 brushes
Distribuidor de cepillos para 10 cepillos
Distributore per spazzolini da 10

75396-02
Bürstenspender für 20 Bürsten
Brush dispensor for 20 brushes
Distribuidor de cepillos para 20 cepillos
Distributore per spazzolini da 20

Hygiene
Hygiene
Higiene
Igiene



PROBE AND PACKER
75450-00
14,5 cm, 5 3/4"



SPATULA AND PACKER
75440-00
14,5 cm, 5 3/4"



mit Loch, with hole,
con agujero, con foro

75430-12 = 1,5 mm + 2 mm
75430-13 = 1,5 mm + 2,5 mm
14,5 cm, 5 3/4"



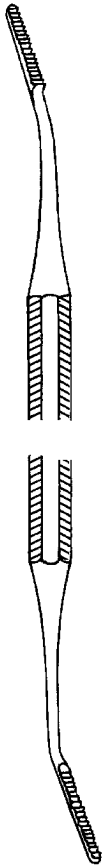
14,5 cm, 5 3/4"
ohne Loch, without hole,
sin agujero, senza foro

75400-01 = 1 mm
75400-02 = 1,5 mm
75400-03 = 2 mm
75400-04 = 2,5 mm

mit Loch, with hole,
con agujero, con foro

75410-01 = 1 mm
75410-02 = 1,5 mm
75410-03 = 2 mm
75410-04 = 2,5 mm

Hygiene
Hygiene
Higiene
Igiene



75410-15
17,5 cm, 6³/₄"



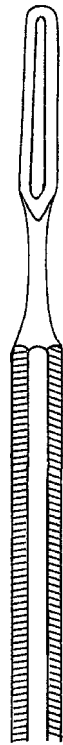
75420-15
15 cm, 6"



75430-01
12,5 cm, 5"



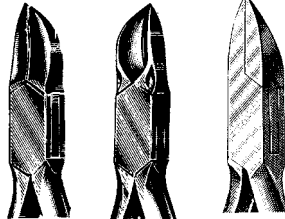
75440-11
11,5 cm, 4¹/₂"



INGROWN
75445-12
12,5 cm, 5"

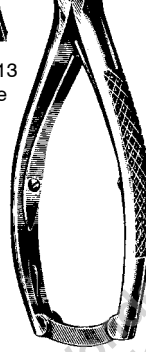
Nagelzangen
Nail Nippers
Alicates corta-uñas
Tronchesini per unghie

stainless steel



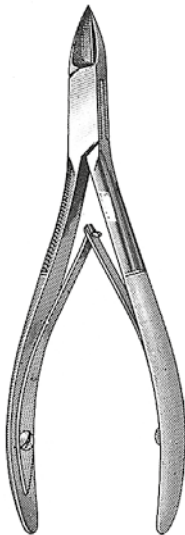
75450-13
concave

75460-13
gerade
straight
recto
retta



14,5 cm, 5 ³/₄"

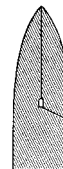
stainless steel



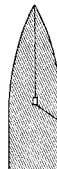
75470-11
10 cm
4"



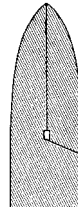
75475-11
11,5 cm
4 ¹/₂"



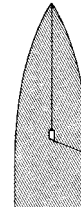
75480-13
12,5 cm
5"



fine
75485-13
12,5 cm
5"



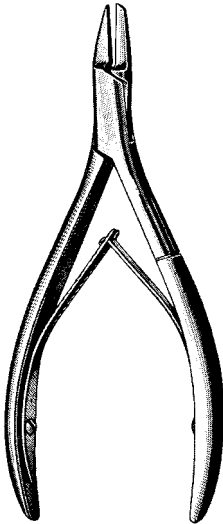
75490-15
15 cm
6"



fine
75500-15
15 cm
6"

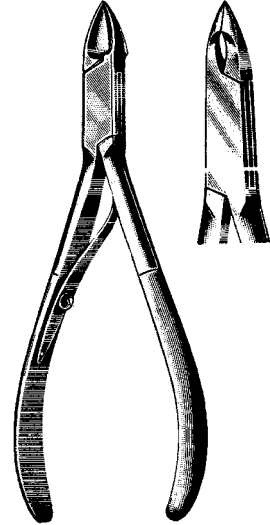
Nagelzangen
Nail Nippers
Alicates corta-uñas
Tronchesini per unghie

stainless steel



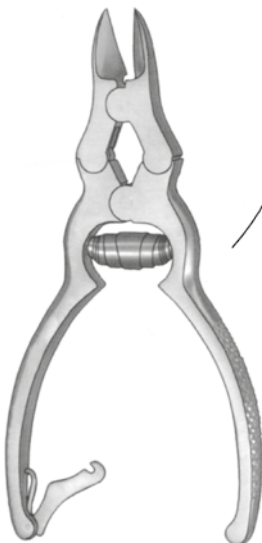
ANVIL
75550-13
13 cm, 5 1/8"

stainless steel

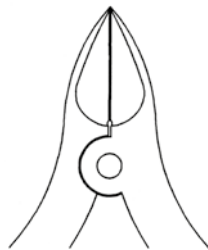


75600-10
10 cm, 4"

stainless steel

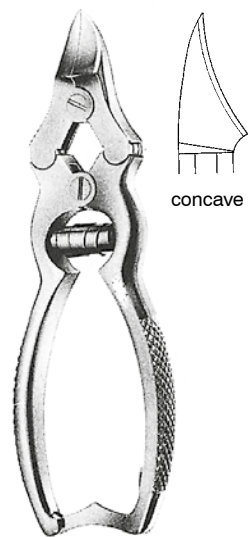


75618-15
15,2 cm, 6"



gerade
straight

stainless steel



75620-15
15,5 cm, 6"

concave

Wondershare
PDFelement

Nagelzangen, Nagelspaltscheren
Nail Nippers, Nail splitting scissors
Alicates corta-uñas, Tijeras para hender uñas
Tronchesini per unghie, Forbici per staccare unghie

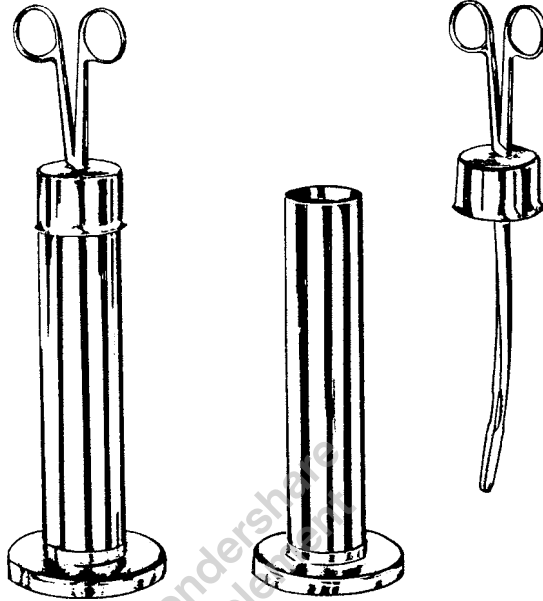


75630-12
12 cm, 4³/₄"

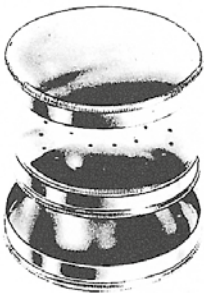


75640-15
15 cm, 6"

Kappenzangen, Nadel-Sterilisierkästen
 Sterilizing Forceps, Needle Sterilizing cases
 Combinacion tapa-pinza, Estuches para esterilizar agujas
 Pinza coperchio, Scatole per sterilizzare aghi



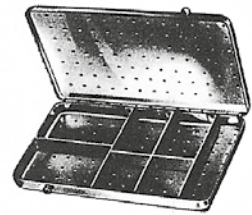
89111-25 25 cm, 10"
 89111-32 32 cm, 12³/₄"



89112-65
 65 x 15 mm



89113-65



89114-00
 150 x 95 x 13 mm



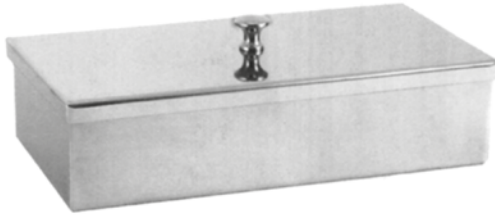
89115-50 50 x 25 x 4,5 mm
 89115-65 65 x 42 x 8,0 mm
 89115-75 75 x 25 x 4,5 mm



89116-50 50 x 25 x 4,5 mm
 89116-65 65 x 42 x 8,0 mm
 89116-75 75 x 25 x 4,5 mm



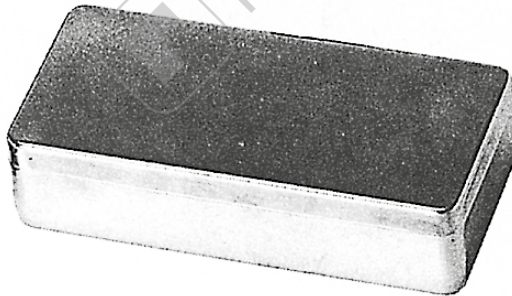
Instrumentenkästen
Instrument Boxes
Cajas para instrumentos
Scatole per strumenti



Abmessungen in mm
Sizes in mm
tamaños en mm
misura in mm

l x b x h mm
400x200x80
500x270x70

89121-40
89121-50



Abmessungen in mm
Sizes in mm
tamaños en mm
misura in mm

l x b x h mm
165x 85x35
200x100x50
260x150x50
300x200x50

Deckel ohne Knopf
lid without knob
tapa sin botón
coperchio senza bottone

89122-16
89122-21
89122-26
89122-30

Sterilisierkästen
Sterilizing Cases
Cajas para esterilización
Scatole per sterilizzazione



Abmessungen in mm (l x b x h)
Sizes in mm (l x b x h)
tamaños en mm (l x f x a)
misura in mm (l x l x a)

230 x 130 x 50
260 x 150 x 50
275 x 235 x 50
300 x 200 x 50
325 x 275 x 50
420 x 175 x 50

230 x 130 x 75
260 x 150 x 75
300 x 200 x 75
325 x 275 x 75
420 x 175 x 75

Behälter
Containers
Recipientes
Recipienti

89124-23
89124-26
89124-27
89124-30
89124-32
89124-42

89125-23
89125-26
89125-30
89125-32
89125-42

Satz Spezialfilter (5 Paar)
Set of spezial filters (5 pairs)
Juego de filtros especiales (5 pares)
Set die 5 paia di filtri speciali

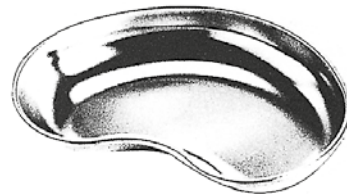
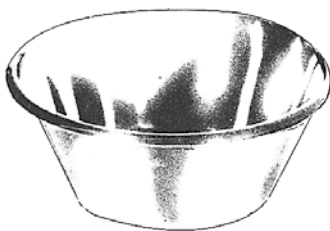
89126-23
89126-26
89126-27
89126-30
89126-32
89126-42

89127-23
89127-26
89127-30
89127-32
89127-42

Schüsseln
Bowls
Cubetas
Scodelle18/10
Stainless Steel
Acero inoxidable
Acciajo inossidabilematt
satin finish
pulidas mate
opaco

Abmessungen in mm sizes in mm Tamaños en mm misura in mm Ø x h	Inhalt capacity capacidad capacità l	
40x19	0,05	89127-04
61x30	0,07	89127-06
80x40	0,14	89127-08
116x50	0,35	89127-11
128x55	0,45	89127-12
147x65	0,70	89127-14
167x75	1,10	89127-16
187x85	1,60	89127-18

Abmessungen in mm sizes in mm Tamaños en mm misura in mm Ø x h	Inhalt capacity capacidad capacità l	
100x30	0,15	89129-11



	mm x mm	l
89133-16	165 x 60	0,75
89133-17	175 x 70	1,00
89133-22	220 x 80	2,00
89133-24	240 x 110	3,00
89133-31	310 x 120	6,00
89133-34	345 x 125	8,50
89133-38	380 x 130	11,00

89139-17	170 x 100 x 35 mm	0,50 l
89139-25	250 x 140 x 40 mm	1,25 l
89139-27	275 x 150 x 45 mm	2,25 l

Meßbecher, Dose, Standgefäß, Mehrzweckschalen
 Graduated Measures, Box, Jars, Universal Trays
 Copas graduadas, Recipientes, Tarros, Bandejas para instrumentos
 Bicchieri graduati, Recipienti, Recipienti cilindrici, Bacinelle per strumenti



l	
0,25	89140-02
0,5	89140-05
1,0	89140-10
2,0	89140-20



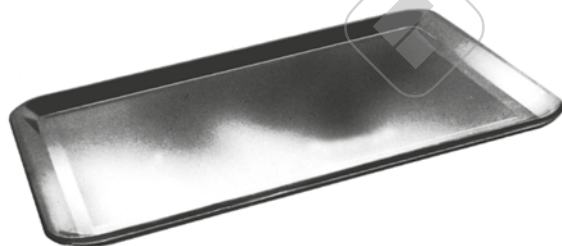
89141-10
 100 x 20 mm

18/10
 Stainless Steel
 Acero inoxidable
 Acciajo inossidabile

matt
 satin finish
 pulidas mate
 opaco



	mmxmm
89142-01	30x 90
89142-02	50x100
89142-03	50x130
89142-04	50x175
89142-05	75x100
89142-06	75x130
89142-07	75x175



89147-21 - 89147-42

	l x b x h
89147-21	210x160x10 mm
89147-24	240x180x10 mm
89147-30	310x150x10 mm
89147-31	310x210x10 mm
89147-35	350x240x10 mm
89147-40	400x270x20 mm
89147-42	420x280x10 mm



89145-23 - 89145-40

	l x b x h
89145-23	230x155x30 mm
89145-30	300x175x30 mm
89145-31	300x175x40 mm
89145-35	350x240x36 mm

Wattedosen, Medizinlöffel, -becher
 Cotton wool containers, Medicine Spoon and Cups
 Distribuidores de algodón, Cuchara graduada, Vasos graduados
 Vaso portacotone, Cucchiaino per medicinali, bicchieri per medicinali



mit Deckel
with Lid
Tapa
Coperchio



89146-20 20 cc
110 x 20 mm

	ø	h	l
89143-00	6 cm	6 cm	0,15 l
89143-01	8,5 cm	8,5 cm	0,4 l
89143-02	8,5 cm	12,5 cm	0,6 l
89143-03	8,5 cm	5 cm	0,25 l
89143-04	10 cm	10 cm	0,75 l
89143-05	10 cm	5 cm	0,35 l
89143-06	12 cm	12 cm	1,25 l
89143-07	15 cm	15 cm	2,5 l
89143-08	15 cm	10 cm	1,75 l
89143-09	20 cm	20 cm	6 l
89143-10	20 cm	10 cm	3 l



89147-10 100 cc
89147-25 250 cc



89148-25 25 cc
89148-50 50 cc

Stechbecken, Plazentabecken, Sputumbecher
Bed Pan, Placenta Pan, Sputum Cup
Silleta, Cubeta para placenta, Escupidera
Padella, bacinella per placenta, Sputacchiera



89148-31
ø 310 mm



89148-32



89148-35
350 x 290 x 90 mm



89150-30
90 x 80 mm



Verbandstofftrommel, Sterilisiersiebkorb
 Sterilizing Drums, Sterilization Trays
 Tambores p. esterilización, Cestas de esterilización
 Tamburi p. sterilizzazione, Cestelli per erilizzazione



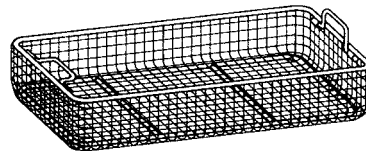
SCHIMMELBUSCH

Ø

mmxmm

89152-08	125x 80
89152-10	125x100
89152-12	125x125
89155-08	150x 80
89155-10	150x100
89155-13	150x130
89155-15	150x150
89155-19	150x190
89159-14	190x145
89159-16	190x165
89159-19	190x190
89159-24	190x240
89164-14	240x145
89164-16	240x165
89164-19	240x190
89164-24	240x240
89164-29	240x290
89164-34	240x340
89164-39	240x390
89169-14	290x145
89169-16	290x165
89169-19	290x190
89169-24	290x240
89169-29	290x290
89169-34	290x340
89169-39	290x390
89174-14	340x145
89174-16	340x165
89174-19	340x190
89174-24	340x240
89174-29	340x290
89174-34	340x340
89174-39	340x390
89179-14	390x145
89179-16	390x165
89179-19	390x190
89179-24	390x240
89179-29	390x290
89179-34	390x340
89179-39	390x390
89179-49	390x490
89179-59	390x590

18/10
 Stainless Steel
 Acero inoxidable
 Acciaio inossidabile
 Acciaio inossidabile



R390.03	255x245x 30 mm
R390.05	255x245x 50 mm
R390.07	255x245x 70 mm
R390.10	255x245x100 mm

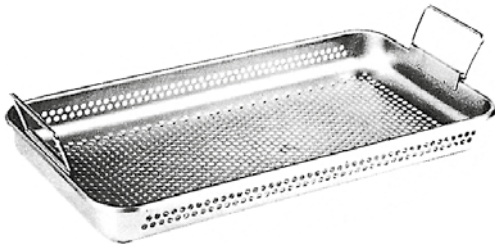
R190.03	485x255x 30 mm
R190.05	485x255x 50 mm
R190.07	485x255x 70 mm
R190.10	485x255x100 mm

R191.03	540x255x 30 mm
R191.05	540x255x 50 mm
R191.07	540x255x 70 mm
R191.10	540x255x100 mm

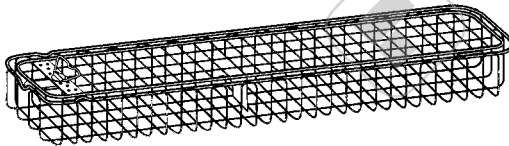
Siebschalen, Endoskopiekorb
Trays
Bandejas
Cestelli

Aus perforiertem Blech
From Perforated Sheet Metal
De chapa de acero perforada
In acciaio perforato

18/10
Stainless Steel
Acero inoxidable
Acciaio inossidabile



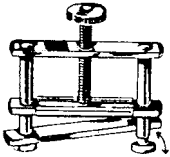
	mm x mm x mm
89250-10	240 x 240 x 50
89250-20	240 x 240 x 80
89250-30	240 x 240 x 100
89250-40	480 x 260 x 50
89250-50	520 x 260 x 80
89250-60	520 x 260 x 100



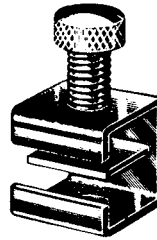
für 1 Endoskop, for 1 endoscope, para 1 endoscopio, per 1 endoscopio	
89256-29	290x80x52 mm
89256-46	460x80x52 mm
89256-67	670x80x52 mm

für 2 Endoskope, for 2 endoscopes, para 2 endoscopios, per 2 endoscopi rigidi	
89257-46	460x80x52 mm

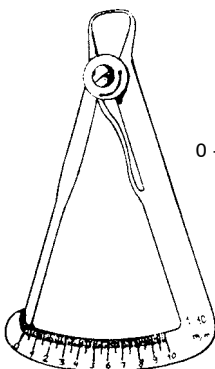
Schlauchklemmen, Messgerät, Sterilisierklammern
 Tubing Clamp, Decimal spring caliper, Safety pins
 Pinzas para tubos, calibrador decimal, Cadres de esterilizacion
 Morsetti serratubi, compasso, pinze per sterilizzazione



HOFFMANN
 89260-13 13 mm
 89260-17 17 mm
 89260-20 20 mm
 89260-25 25 mm
 89260-30 30 mm
 89260-40 40 mm



SIMPLEX
 89265-12

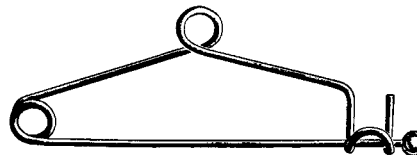


IWANSON
 89270-15

0 - 10 mm



BUNT
 29150-12
 12 cm, 4^{3/4}"



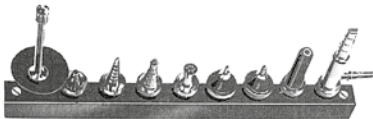
MAYO
 29152-14
 14 cm, 5^{1/2}"



Reinigungspistole
Water Jet Pistol
Pistola-lavatora
Pistola lavatrice



89500-00
komplett mit 9 Aufsätzen
complete with 9 tips
con 9 toberas
completa con 9 raccordi



89500-01
Reinigungsaufsatz für Flaschen
Cleansing Tip for bottles
Tobera para botellas
Raccordo di lavaggio per bottiglie



89500-02
Reinigungsaufsatz für Recordspritzen-Konen
Cleansing Tip for Cones of Record Syringes
Tobera para conos de jeringas Record
Raccordo per coni di siringhe Record



89500-03
Reinigungsaufsatz für Katheter
Cleansing Tip for Catheters
Tobera para catéteres
Raccordo di lavaggio per cateteri



89500-04
Reinigungsaufsatz für Drainageschläuche
Cleansing Tip for Drainage Tubings
Tobera para tubos de drenaje
Raccordo di lavaggio per tubi di drenaggio



89500-05
Reinigungsaufsatz für Hohlgefäße (Brause)
Cleansing Tip for Receptacles (Shower)
Tobera para recipientes (ducha)
Raccordo di lavaggio per recipienti (doccia)

89500-12
Pistole allein
Pistol only
Pistola sola
Pistola sola

89500-06
Reinigungsaufsatz für Kanülen mit Recordkonus
Cleansing Tip for hypodermic needles with Record Cone
Tobera para agujas de inyección con cono Record
Raccordo di lavaggio per aghi ipodermici con cono Record



89500-07
Reinigungsaufsatz für Kanülen mit Luerkonus
Cleansing Tip for hypodermic needles with Luer Cone
Tobera para agujas de inyección con cono Luer
Raccordo di lavaggio per aghi ipodermici con cono Luer



89500-08
Reinigungsaufsatz für Meß- und Vollpipetten
Cleansing Tip for Meas. and Volumetric Pipettes
Tobera para pipetas de medida y volumétricas
Raccordo di lavaggio per pipette comuni e graduate



89500-09
Reinigungsaufsatz für feine Pipetten
Cleansing Tip for fine pipettes
Tobera para pipetas finas
Raccordo di lavaggio per pipette fine



89500-10
Reinigungsaufsatz 31 cm (12 1/4") gerade
Cleansing Tip 31 cm (12 1/4") straight
Tobera 31 cm (12 1/4") recta
Raccordo 31 cm (12 1/4") rette



89500-11
Reinigungsaufsatz 30 cm (11 3/4") aufgebogen
Cleansing Tip 30 cm (11 3/4") curved
Tobera 30 cm (11 3/4") curva
Raccordo di lavaggio 30 cm (11 3/4") curvo

89501-03
Überwurfmutter zum Anschluß an Gewindehähne
Couplings for connection to water tap
Tuercas-hembras para conexión al grifo de agua
Dadi premistoppa per connessione ai rubinetti filettati



Hochfrequenz-Chirurgie
High Frequency Surgery
Electrocirugía
Elettrochirurgia

Mindestbestellmenge 10
Minimum order quantity 10
Cantidad minima 10
Minimo di quantitativo 10



91010-01
Fig. 1



91010-02
Fig. 2 45°



91010-03
Fig. 3 120°



91010-11
Fig. 11
Ø 3 mm



91010-12
Fig. 12
Ø 5 mm



91010-13
Fig. 13
Ø 8 mm



91010-14
Fig. 14



91010-15
Fig. 15 45°
7,0x1,5 mm



91010-16
Fig. 16 45°
7 mm



91010-17
Fig. 17
6,0x1,3 mm



91010-18
Fig. 18 30°
7,0x1,7 mm



91010-21
Fig. 21
7,0x1,7 mm



91010-31
Fig. 31 45°
Ø 0,6 mm



91010-33
Fig. 33 45°
Ø 1,7 mm



91010-34
Fig. 34 45°
Ø 3,0 mm



91010-35
Fig. 35



91010-36
Fig. 36 90°

Schaft
shaft
vástago
asta
Ø 2,4 mm

Hochfrequenz-Chirurgie
High Frequency Surgery
Electrochirurgia
Elettrochirurgia

Mindestbestellmenge 10
Minimum order quantity 10
Cantidad minima 10
Minimo di quantitativo 10



91011-51
Fig. 51 45°
Ø 3 mm



91011-52
Fig. 52 45°
7,0x1,7 mm



91011-53
Fig. 53 45°



91011-54
Fig. 54



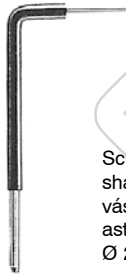
91011-55
Fig. 55



91011-56
Fig. 56 45°
Ø 5 mm



91011-61
Fig. 61 45°



91011-62
Fig. 62 90°

Schaft
shaft
vástago
asta
Ø 2,4 mm

Serie STANDARD



91020-01



91020-02

Schaft
shaft
vástago
asta
Ø 4 mm



91020-03



91020-04



Ø mm
5 91022-05
10 91022-10
20 91022-20



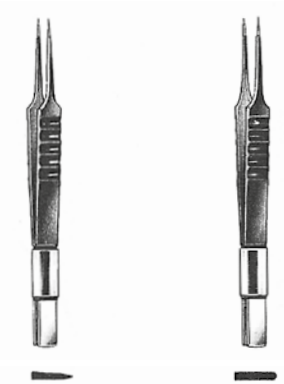
Ø mm
10 91024-10
15 91024-15
20 91024-20



Ø mm
2 91030-02
4 91030-04
6 91030-06

Schaft
shaft
vástago
asta
Ø 4 mm

Bipolare Koagulation
Bipolar Coagulation
Coagulación bipolar
Coagulazione bipolare



91102-11
11 cm, 4 $\frac{3}{8}$ "



91104-11
11 cm, 4 $\frac{3}{8}$ "



91109-11
11 cm, 4 $\frac{3}{8}$ "
45°
0.5 mm



91113-11
11 cm, 4 $\frac{3}{8}$ "
45°
0.5 mm



91115-11
11 cm, 4 $\frac{3}{8}$ "
45°
0.5 mm



91122-16
16,5 cm, 6 $\frac{1}{2}$ "
0.5 mm



91123-16
16,5 cm, 6 $\frac{1}{2}$ "
0.5 mm



91124-16
16,5 cm, 6 $\frac{1}{2}$ "
1 mm



91125-16
16,5 cm, 6 $\frac{1}{2}$ "
0.5 mm



91127-16
16,5 cm, 6 $\frac{1}{2}$ "
1 mm

Bipolare Koagulation
Bipolar Coagulation
Coagulación bipolar
Coagulazione bipolare



91142-16
16,5 cm, 6 1/2"
1 mm



91144-16
16,5 cm, 6 1/2"
0,5 mm



91146-16
16,5 cm, 6 1/2"
1 mm



91152-19
19,5 cm, 7 3/4"
0,3 mm



91154-19
19,5 cm, 7 3/4"
1 mm



91157-19
19,5 cm, 7 3/4"
1 mm



91159-19
19,5 cm, 7 3/4"
2 mm

Bipolare Koagulation
Bipolar Coagulation
Coagulación bipolar
Coagulazione bipolare



91162-19
19,5 cm, 7 3/4"
0,3 mm



91164-19
19,5 cm, 7 3/4"
1 mm



91166-19
19,5 cm, 7 3/4"
2 mm



91167-19
19,5 cm, 7 3/4"
1 mm



91169-19
19,5 cm, 7 3/4"
1 mm



91172-03
0,3 mm



91172-07
0,7 mm



91172-12
1,2 mm

91172-03 - 91172-12
22,5 cm, 8,9"

Verbindungskabel, bipolar
 Connection Cords, bipolar
 Cables de conexión, bipolar
 Cavi da connessione, bipolare



ERBE
 SELECT
 STORZ
 3 m 118" 91190-30
 5 m 197" 91190-50



USA Mod.
 91192-30
 91192-50



MARTIN
 BERCHTOLD
 AESCULAP
 91193-30
 91193-50

für Elektro-Chirurgie-Einheiten
 for Electrosurgery Equipment
 para Electrobisturías
 per Elettrobisturi

Monopolare Pinzetten
 Monopolar Forceps
 Pinzas monopolares
 Pinze monopolare



91800-18 18 cm, 7"
 91800-21 21 cm, 8 1/4"
 91800-25 25 cm, 10"

ohne Buchse
 without socket
 sin casquillo
 senza presa

91801-18 18 cm, 7"
 91801-21 21 cm, 8 1/4"
 91801-25 25 cm, 10"

mit Buchse
 with socket
 con casquillo
 con presa

Instrumentenöl
Instrument oil
Oleo para instrumentos
Olio per strumenti

INSTRU CARE ist ein Instrumentenpflegeöl auf der Basis von hochreinen medizinischen Weißölen zum Erhalt der Funktionsfähigkeit und Werterhaltung von chirurgischen Instrumenten. Die Anwendung erfolgt nach der Reinigung bzw. vor dem Sterilisationsvorgang.

INSTRU CARE is an instrument oil for care and protection of surgical instruments and guaranties the function and protects the value of instruments. It will be used after cleansing and before sterilization process.

INSTRU CARE olio para instrumentos

INSTRU CARE è un olio estremamente puro per la lubrificazione e la pulizia dello strumentario chirurgico. Privo di silicone, appropriato per la sterilizzazione a vapore e ad aria calda. Fisiologicamente inerte con utilizzo prima della sterilizzazione.

Kunststoff-Flasche / plastic bottle / bottiglia / botella
100ml 98000-01

Sprühdose / aerosol / spray / spray
400ml 98000-02



03112-00.....5	05151-02.....27	05311-01.....37	07402-08.....46	09121-20.....51
03112-01.....5	05160-02.....28	05311-02.....37	07402-09.....46	09124-14.....51
03112-02.....5	05160-03.....28	05311-03.....37	07402-10.....46	09125-14.....51
03113-00.....6	05160-04.....28	05311-04.....37	07403-01.....47	09128-14.....52
03113-01.....6	05170-24.....28	05320-01.....37	07403-02.....47	09130-14.....52
03113-02.....6	05190-17.....28	05320-02.....37	07410-05.....47	09131-14.....52
03114-00.....7	05190-20.....28	05320-03.....37	07412-05.....47	09140-14.....52
03114-01.....7	05190-25.....28	05320-04.....37	07420-08.....48	09141-14.....52
03114-02.....7	05203-00.....31	05321-01.....37	07421-09.....48	09150-14.....52
03120-00.....8	05204-00.....31	05321-02.....37	07422-19.....48	09151-14.....52
03122-00.....9	05210-00.....29	05321-03.....37	07423-16.....48	09160-14.....52/1
03126-00.....10	05210-01.....29	05321-04.....37	07423-20.....48	09160-17.....52/1
03132-00.....11	05210-02.....29	07103-00.....38	07423-24.....48	09160-19.....52/1
03132-01.....11	05210-03.....29	07103-01.....38	07424-11.....48	09160-23.....52/1
03132-02.....11	05210-04.....29	07103-02.....38	07424-14.....48	09160-28.....52/1
03133-00.....12	05211-00.....29	07104-00.....39	07424-17.....48	09161-14.....52/1
03133-01.....12	05211-01.....29	07104-02.....39	07425-11.....48	09161-17.....52/1
03133-02.....12	05211-02.....29	07105-02.....39	07490-00.....49	09161-19.....52/1
03161-00.....13	05211-03.....29	07106-01.....39/1	07490-01.....49	09161-23.....52/1
03161-01.....14	05211-04.....29	07106-02.....39/1	07490-02.....49	09161-28.....52/1
03161-02.....15	05220-00.....29	07107-00.....39/2	07495-31.....50	09164-14.....52/1
03161-03C.....16	05220-01.....29	07107-01.....39/2	07496-00.....49	09164-17.....52/1
03161-03T.....16	05220-02.....29	07107-03.....39/2	07496-31.....50	09164-23.....52/1
03167-03.....20	05220-03.....29	07107-04.....39/2	07498-00.....50	09165-14.....52/1
03171-00.....17	05220-04.....29	07108-00.....40	07499-00.....50	09165-17.....52/1
03171-01.....17	05221-00.....29	07109-03.....40	07499-01.....50	09165-23.....52/1
03171-02.....17	05221-01.....29	07109-10.....41	09102-11.....51	09170-15.....52/1
03180-90.....21	05221-02.....29	07109-13.....41	09102-13.....51	09170-17.....52/1
03180-92.....21	05221-03.....29	07109-15.....41	09102-14.....51	09170-21.....52/1
03180-93.....21	05221-04.....29	07110-00.....42	09102-15.....51	09171-15.....52/1
03195-00.....22	05223-00.....31	07111-00.....42	09102-16.....51	09171-17.....52/1
03195-01.....22	05224-00.....31	07112-00.....42	09102-18.....51	09171-21.....52/1
03195-04.....22	05230-00.....30	07113-00.....42	09102-20.....51	09174-15.....52/1
03195-06.....22	05230-01.....30	07115-00.....42	09103-11.....51	09174-17.....52/1
03195-07.....22	05230-02.....30	07116-00.....42	09103-13.....51	09174-21.....52/1
03195-08.....22	05230-03.....30	07118-00.....42	09103-14.....51	09175-15.....52/1
03195-09.....22	05230-04.....30	07119-00.....42	09103-15.....51	09175-17.....52/1
03195-10.....22	05233-18.....32	07120-00.....42	09103-16.....51	09175-21.....52/1
03246-00.....23	05234-28.....32	07121-00.....42	09103-18.....51	09180-17.....52/1
03246-01.....23	05234-37.....32	07122-00.....42	09103-20.....51	09181-17.....52/1
03246-02.....23	05238-01.....32	07123-00.....42	09104-14.....51	09190-16.....53
03248-00.....23	05238-02.....33	07124-00.....42	09105-14.....51	09191-16.....53
03260-15.....23	05238-03.....33	07125-00.....42	09110-11.....51	09194-16.....53
03262-18.....23	05239-01.....29/30	07130-00.....42	09110-13.....51	09195-16.....53
03288-17.....24	05239-02.....29/30	07161-00.....41	09110-14.....51	09202-10.....53
03288-20.....24	05239-03.....29	07162-00.....41	09110-15.....51	09203-10.....53
03292-22.....24	05240-30.....34	07165-00.....41	09110-16.....51	09204-22.....53
03294-24.....24	05241-11.....34	07167-00.....41	09110-18.....51	09206-10.....53
03304-20.....24	05241-22.....34	07200-17.....44	09110-20.....51	09207-10.....53
03306-17.....24	05300-01.....36	07200-20.....44	09111-11.....51	09280-12.....53/1
03308-18.....24	05300-02.....36	07201-13.....44	09111-13.....51	09280-15.....53/1
03310-01.....25	05300-03.....36	07201-16.....44	09111-14.....51	09280-18.....53/1
03310-02.....25	05300-04.....36	07201-19.....44	09111-15.....51	09280-20.....53/1
03312-01.....25	05300-05.....36	07201-22.....44	09111-16.....51	09280-23.....53/1
03314-01.....25	05300-06.....36	07202-12.....44	09111-18.....51	09280-25.....53/1
03320-19.....25	05301-01.....35	07203-16.....44	09111-20.....51	09280-28.....53/1
03340-10.....25	05301-02.....35	07203-19.....44	09114-14.....51	09280-30.....53/1
03340-15.....25	05301-03.....35	07203-22.....44	09115-14.....51	09281-12.....53/1
03340-20.....25	05301-04.....35	07204-11.....44	09120-11.....51	09281-15.....53/1
03340-30.....25	05301-05.....35	07205-09.....44	09120-13.....51	09281-18.....53/1
03340-50.....25	05301-06.....35	07290-09.....45	09120-14.....51	09281-20.....53/1
03350-15.....25	05301-07.....35	07291-11.....45	09120-15.....51	09281-23.....53/1
03360-21.....26	05302-01.....36	07294-13.....45	09120-16.....51	09281-25.....53/1
03361-10.....26	05302-02.....36	07296-00.....45/50	09120-18.....51	09281-28.....53/1
05130-05.....27	05302-03.....36	07402-01.....46	09120-20.....51	09281-30.....53/1
05130-10.....27	05303-01.....36	07402-02.....46	09121-11.....51	09282-15.....53/1
05140-05.....27	05304-01.....36	07402-03.....46	09121-13.....51	09282-18.....53/1
05140-08.....27	05310-01.....37	07402-04.....46	09121-14.....51	09282-20.....53/1
05150-21.....27	05310-02.....37	07402-05.....46	09121-15.....51	09282-23.....53/1
05150-27.....27	05310-03.....37	07402-06.....46	09121-16.....51	09282-25.....53/1
05151-01.....27	05310-04.....37	07402-07.....46	09121-18.....51	09282-28.....53/1

09283-15.....	53/1	09348-05.....	55	09505-23.....	63	09829-12.....	67	10013-19.....	73
09283-18.....	53/1	09348-06.....	55	09505-26.....	63	09831-12.....	67	10014-19.....	73
09283-20.....	53/1	09349-09.....	58	09505-30.....	63	09835-12.....	67	10015-19.....	73
09283-23.....	53/1	09349-12.....	55	09507-23.....	63	09850-10.....	68	10016-17.....	73
09283-25.....	53/1	09350-09.....	57	09507-26.....	63	09851-10.....	68	10017-17.....	73
09283-28.....	53/1	09350-10.....	56	09507-30.....	63	09854-11.....	69	10018-20.....	73
09284-12.....	53/1	09351-09.....	57	09510-20.....	62	09859-16.....	69	10019-20.....	73
09284-15.....	53/1	09352-09.....	57	09510-23.....	62	09860-16.....	69	10020-17.....	73
09284-18.....	53/1	09353-09.....	57	09511-20.....	62	09861-16.....	69	10021-17.....	73
09284-20.....	53/1	09354-10.....	57	09511-23.....	62	09898-20.....	69/1	10022-20.....	73
09284-23.....	53/1	09355-10.....	57	09512-20.....	62	09901-09.....	69/1	10023-20.....	73
09284-25.....	53/1	09356-10.....	57	09512-23.....	62	09901-11.....	69/1	10024-17.....	73
09284-28.....	53/1	09357-10.....	57	09513-20.....	62	09901-14.....	69/1	10025-17.....	73
09284-30.....	53/1	09358-11.....	56	09513-23.....	62	09901-18.....	69/1	10026-20.....	73
09285-12.....	53/1	09360-11.....	58	09514-20.....	62	09901-20.....	69/1	10027-20.....	73
09285-15.....	53/1	09361-11.....	58	09514-23.....	62	09905-14.....	69/1	10028-14.....	73
09285-18.....	53/1	09362-11.....	58	09515-20.....	62	09905-18.....	69/1	10029-14.....	73
09285-20.....	53/1	09363-11.....	58	09515-23.....	62	09906-18.....	69/1	10030-18.....	73
09285-23.....	53/1	09370-11.....	58	09516-23.....	62	09906-20.....	69/1	10031-18.....	73
09285-25.....	53/1	09371-11.....	58	09517-23.....	62	09911-23.....	69/1	10032-23.....	73
09285-28.....	53/1	09374-11.....	58	09523-24.....	62	09913-20.....	69/2	10033-23.....	73
09285-30.....	53/1	09375-11.....	58	09525-22.....	63	09913-22.....	69/2	10034-14.....	73
09286-15.....	53/1	09381-11.....	58	09530-17.....	63	09915-23.....	69/2	10035-14.....	73
09286-18.....	53/1	09401-18.....	58	09531-17.....	63	09921-16.....	69/2	10036-18.....	73
09286-20.....	53/1	09403-15.....	58	09536-27.....	63	09921-19.....	69/2	10037-18.....	73
09286-23.....	53/1	09405-16.....	59	09537-27.....	63	09930-14.....	70	10038-23.....	73
09286-25.....	53/1	09406-16.....	59	09540-16.....	61	09931-14.....	70	10039-23.....	73
09286-28.....	53/1	09425-17.....	59	09541-16.....	61	09933-23.....	70	10040-18.....	74
09287-15.....	53/1	09427-17.....	59	09542-16.....	61	09935-23.....	70	10041-18.....	74
09287-18.....	53/1	09435-18.....	59	09543-16.....	61	09937-23.....	70	10042-18.....	74
09287-20.....	53/1	09437-19.....	59	09548-18.....	64	09939-23.....	70	10044-14.....	74
09287-23.....	53/1	09439-17.....	59	09550-10.....	64	09941-20.....	70	10045-14.....	74
09287-25.....	53/1	09468-15.....	59	09551-16.....	64	09950-15.....	70	10046-14.....	74
09287-28.....	53/1	09470-11.....	59	09553-16.....	64	09950-18.....	70	10047-14.....	74
09289-28.....	53/2	09473-21.....	59	09560-14.....	64	09960-14.....	71	10048-14.....	74
09290-25.....	53/2	09475-00.....	60	09560-22.....	64	09961-14.....	71	10049-14.....	74
09291-18.....	54	09475-25.....	60	09580-11.....	65	09962-14.....	71	10102-11.....	75
09291-20.....	54	09475-45.....	60	09581-11.....	65	09962-17.....	71	10104-11.....	75
09291-23.....	54	09475-60.....	60	09582-15.....	65	09962-23.....	71	10110-12.....	75
09295-18.....	54	09475-90.....	60	09583-15.....	65	09963-14.....	71	10111-12.....	75
09295-20.....	54	09476-00.....	60	09601-22.....	65	09963-17.....	71	10113-11.....	75
09295-23.....	54	09476-25.....	60	09610-18.....	65	09963-23.....	71	10115-11.....	75
09296-15.....	54	09476-45.....	60	09611-18.....	65	09964-15.....	71	10117-11.....	75
09296-18.....	54	09476-60.....	60	09613-20.....	65/1	09964-17.....	71	10119-10.....	75
09296-23.....	54	09476-90.....	60	09614-19.....	65/1	09965-15.....	71	10120-16.....	76
09302-14.....	54/1	09477-01.....	60	09617-13.....	65/1	09965-17.....	71	10120-18.....	76
09303-14.....	54/1	09478-25.....	60	09619-17.....	65/1	09966-11.....	71	10120-22.....	76
09304-14.....	54/1	09478-45.....	60	09641-30.....	65/2	09967-11.....	71	10121-16.....	76
09305-14.....	54/1	09478-60.....	60	09643-19.....	65/2	09970-14.....	71	10121-18.....	76
09310-12.....	54/1	09479-25.....	60	09643-25.....	65/2	09970-18.....	71	10121-22.....	76
09310-15.....	54/1	09479-45.....	60	09651-24.....	65/2	09970-20.....	71	10122-16.....	76
09312-12.....	54/1	09479-60.....	60	09661-23.....	65/2	09970-23.....	71	10122-18.....	76
09314-12.....	54/1	09480-25.....	61	09770-18.....	66	09971-14.....	71	10122-22.....	76
09320-15.....	54/1	09480-40.....	61	09772-21.....	66	09971-18.....	71	10123-16.....	76
09321-15.....	54/1	09480-60.....	61	09774-21.....	66	09971-20.....	71	10123-18.....	76
09321-18.....	54/1	09481-25.....	61	09775-13.....	66	09971-23.....	71	10123-22.....	76
09325-15.....	54/1	09481-40.....	61	09777-13.....	66	09980-11.....	72	10124-16.....	76
09340-09.....	54/2	09481-60.....	61	09802-09.....	66	09981-11.....	72	10124-18.....	76
09340-10.....	54/2	09490-16.....	61	09802-11.....	66	09982-12.....	72	10124-22.....	76
09340-11.....	54/2	09490-23.....	61	09803-09.....	66	09983-12.....	72	10125-16.....	76
09341-09.....	54/2	09490-28.....	61	09803-13.....	66	09984-11.....	72	10125-18.....	76
09341-10.....	54/2	09491-16.....	61	09804-14.....	66	09985-11.....	72	10125-22.....	76
09341-11.....	54/2	09491-23.....	61	09809-15.....	66	09986-11.....	72	10126-00.....	77
09344-11.....	54/2	09491-28.....	61	09820-13.....	67	09990-14.....	72	10126-25.....	77
09345-11.....	54/2	09492-16.....	61	09821-13.....	67	09990-18.....	72	10126-45.....	77
09346-11.....	54/2	09492-23.....	61	09823-12.....	67	09993-15.....	72	10126-60.....	77
09347-09.....	58	09492-28.....	61	09824-12.....	67	09993-18.....	72	10126-90.....	77
09348-01.....	55	09496-15.....	61	09825-12.....	67	09995-12.....	72	10127-00.....	77
09348-02.....	55	09497-15.....	61	09826-12.....	67	10010-19.....	73	10127-25.....	77
09348-03.....	55	09501-22.....	63	09827-12.....	67	10011-19.....	73	10127-45.....	77
09348-04.....	55	09501-23.....	63	09828-12.....	67	10012-19.....	73	10127-60.....	77

10127-90.....77	11120-25.....81/1	11232-15.....83	11404-04.....90	12340-16.....99
10128-09.....78	11120-30.....81/1	11233-20.....84	11405-05.....90	12340-20.....99
10128-15.....78	11122-12.....81/1	11234-20.....84	11407-07.....90	12340-24.....99
10129-15.....78	11122-13.....81/1	11235-20.....84	11802-09.....91	13001-08.....101
10130-15.....78	11122-14.....81/1	11236-15.....84	11802-10.....91	13001-10.....101
10131-14.....78	11122-15.....81/1	11236-20.....84	11802-11.....91	13001-12.....101
10131-18.....78	11122-18.....81/1	11237-20.....84	11810-07.....91	13002-08.....101
10132-18.....78	11122-21.....81/1	11240-14.....84	11810-09.....91	13002-10.....101
10133-10.....79	11122-25.....81/1	11242-14.....84	11810-11.....91	13002-12.....101
10135-10.....79	11124-15.....81/1	11246-18.....85	11812-10.....91	13005-10.....101
10137-01.....78	11126-18.....81	11248-18.....85	11813-10.....91	13005-14.....101
10137-02.....78	11126-21.....81	11250-14.....85	11815-12.....91	13005-20.....101
10140-08.....79	11126-25.....81	11252-20.....85	11816-10.....91	13006-10.....101
10141-08.....79	11130-11.....81/1	11256-15.....85	11817-10.....91	13006-14.....101
10142-08.....79	11130-13.....81/1	11256-20.....85	11821-11.....92	13006-20.....101
10143-08.....79	11130-14.....81/1	11256-25.....85	11822-13.....92	13010-30.....102
10151-11.....79	11130-16.....81/1	11257-15.....85	11823-13.....92	13010-35.....102
10153-11.....79	11130-18.....81/1	11258-15.....85	11824-14.....92	13010-40.....102
10155-11.....79	11130-20.....81/1	11259-15.....85	11825-14.....92	13010-50.....102
10202-18.....80	11132-16.....81/1	11260-12.....86	11828-15.....92	13011-30.....102
10203-18.....80	11132-18.....81/1	11260-15.....86	11900-01.....93	13011-35.....102
10313-14.....80	11132-20.....81/1	11261-15.....86	11901-05.....93	13011-40.....102
10313-16.....80	11132-25.....81/1	11270-12.....86	11910-01.....93	13011-50.....102
10320-09.....80	11132-30.....81/1	11270-15.....86	12102-12.....94	13012-30.....102
10330-19.....80	11140-11.....81/1	11271-15.....86	12103-12.....94	13012-35.....102
10331-19.....80	11140-13.....81/1	11271-18.....86	12104-15.....94	13012-40.....102
10333-19.....80	11140-14.....81/1	11272-15.....86	12105-15.....94	13012-50.....102
11102-10.....81	11140-16.....81/1	11273-15.....86	12108-18.....94	13013-30.....102
11102-11.....81	11140-18.....81/1	11274-06.....86	12109-18.....94	13013-35.....102
11102-13.....81	11140-20.....81/1	11274-08.....86	12110-15.....95	13013-40.....102
11102-14.....81	11140-25.....81/1	11274-10.....86	12110-20.....95	13013-50.....102
11102-16.....81	11150-13.....81/1	11302-17.....86	12110-24.....95	13014-30.....102
11102-18.....81	11150-14.....81/1	11302-23.....86	12110-30.....95	13014-35.....102
11102-20.....81	11150-16.....81/1	11303-17.....86	12200-16.....96	13014-40.....102
11102-25.....81	11160-13.....81/1	11304-17.....86	12201-16.....96	13014-50.....102
11102-30.....81	11160-14.....81/1	11305-17.....87	12291-22.....97	13015-30.....102
11103-14.....81	11160-16.....81/1	11310-17.....87	12293-22.....97	13015-35.....102
11104-12.....81	11170-12.....81/2	11311-17.....87	12295-22.....97	13015-40.....102
11104-13.....81	11170-15.....81/2	11312-17.....87	12297-22.....97	13015-50.....102
11104-14.....81	11174-12.....81/2	11312-18.....87	12302-16.....98	13090-40.....100
11104-15.....81	11174-15.....81/2	11313-17.....87	12302-20.....98	13090-45.....100
11104-18.....81	11176-12.....81/2	11314-01.....87	12302-24.....98	13090-50.....100
11104-21.....81	11176-15.....81/2	11314-02.....87	12304-16.....98	13091-40.....100
11104-25.....81	11177-12.....81/2	11315-01.....87	12304-20.....98	13091-45.....100
11106-13.....81	11178-12.....81/2	11315-02.....87	12304-24.....98	13091-50.....100
11106-15.....81	11179-12.....81/2	11316-14.....88	12304-30.....98	13092-07.....103
11110-11.....81	11180-12.....82	11316-16.....88	12306-16.....98	13092-08.....103
11110-13.....81	11180-15.....82	11316-20.....88	12306-20.....98	13092-10.....103
11110-14.....81	11181-12.....82	11317-00.....88	12306-24.....98	13092-12.....103
11110-16.....81	11181-15.....82	11317-12.....88	12306-30.....98	13093-07.....103
11110-18.....81	11186-12.....82	11317-23.....88	12308-16.....98	13093-08.....103
11110-20.....81	11186-15.....82	11318-18.....88	12308-20.....98	13093-10.....103
11110-25.....81	11187-12.....82	11318-20.....88	12308-24.....98	13093-12.....103
11110-30.....81	11187-18.....83	11318-25.....88	12308-30.....98	13096-06.....103
11112-18.....81	11187-20.....83	11319-12.....88	12309-16.....98	13096-07.....103
11112-21.....81	11187-25.....83	11319-14.....88	12309-20.....98	13096-09.....103
11112-25.....81	11187-30.....83	11320-18.....88	12309-24.....98	13096-11.....103
11114-14.....81	11188-12.....82	11320-23.....88	12309-30.....98	13097-06.....103
11114-16.....81	11188-15.....82	11322-15.....89	12310-16.....98	13097-07.....103
11114-20.....81	11189-12.....82	11322-18.....89	12310-20.....98	13097-09.....103
11114-25.....81	11189-15.....83	11322-23.....89	12310-24.....98	13097-11.....103
11116-18.....81	11189-20.....83	11324-23.....89	12310-30.....98	13098-06.....100
11116-21.....81	11189-25.....83	11325-15.....89	12320-15.....99	13099-07.....100
11116-25.....81	11190-10.....83	11325-23.....89	12320-20.....99	13102-04.....104
11120-10.....81/1	11220-17.....83	11325-25.....89	12320-24.....99	13102-05.....104
11120-11.....81/1	11221-17.....83	11326-23.....89	12325-16.....99	13103-04.....104
11120-13.....81/1	11222-17.....83	11328-15.....89	12325-20.....99	13103-05.....104
11120-14.....81/1	11223-17.....83	11328-20.....89	12325-24.....99	13110-50.....104
11120-16.....81/1	11224-17.....83	11401-01.....90	12330-16.....99	13110-55.....104
11120-18.....81/1	11225-17.....83	11403-03.....90	12330-20.....99	13110-65.....104
11120-20.....81/1	11231-20.....84	11403-04.....90	12330-24.....99	13110-70.....104

13110-75.....104	13310-24.....108	13381-15.....111	13447-20.....117	13580-80.....126
13110-90.....104	13310-26.....108	13382-15.....111	13448-22.....117	13591-20.....126
13111-50.....104	13310-30.....108	13383-15.....111	13449-22.....117	13591-23.....126
13111-55.....104	13311-13.....108	13384-20.....112	13450-24.....118	13593-20.....126
13111-65.....104	13311-14.....108	13384-26.....112	13451-24.....118	13593-23.....126
13111-70.....104	13311-16.....108	13385-20.....112	13453-18.....118	13595-10.....127
13111-75.....104	13311-18.....108	13385-26.....112	13453-24.....118	13595-20.....127
13111-90.....104	13311-20.....108	13386-20.....112	13455-01.....118	13595-30.....127
13115-00.....104	13311-22.....108	13386-26.....112	13455-02.....118	13595-40.....127
13210-10.....104	13311-24.....108	13387-20.....112	13456-01.....119	13597-10.....127
13211-10.....104	13311-26.....108	13387-26.....112	13456-02.....119	13597-20.....127
13212-10.....104	13311-30.....108	13390-20.....112	13456-03.....119	13597-30.....127
13213-10.....104	13312-14.....108	13391-20.....112	13457-28.....119	13598-40.....127
13214-10.....104	13312-16.....108	13391-23.....112	13459-18.....119	13598-24.....126
13215-10.....104	13313-14.....108	13393-20.....112	13459-28.....119	13599-24.....126
13220-12.....105	13313-16.....108	13394-20.....112	13471-14.....119/1	13600-20.....127
13220-14.....105	13320-13.....108	13395-20.....112	13471-16.....119/1	13601-20.....127
13220-18.....105	13320-14.....108	13410-18.....112	13471-18.....119/1	13605-26.....128
13220-21.....105	13320-16.....108	13411-18.....112	13471-23.....119/1	13610-21.....128/1
13221-12.....105	13320-18.....108	13412-18.....113	13473-22.....119/1	13611-21.....128/1
13221-14.....105	13320-20.....108	13413-18.....113	13474-19.....119/1	13612-21.....128/1
13221-18.....105	13320-22.....108	13414-20.....113	13474-24.....119/1	13613-21.....128/1
13221-21.....105	13320-24.....108	13415-14.....113	13474-26.....119/1	13620-24.....128/1
13222-12.....105	13320-26.....108	13415-18.....113	13475-14.....119/1	13620-26.....128/1
13223-12.....105	13320-30.....108	13416-18.....113	13475-18.....119/1	13620-30.....128/1
13224-12.....105	13321-13.....108	13420-14.....114	13477-15.....119/2	13621-24.....128/1
13225-12.....105	13321-14.....108	13421-01.....114	13477-19.....119/2	13621-26.....128/1
13226-12.....105	13321-16.....108	13421-02.....114	13479-22.....119/2	13621-30.....128/1
13227-12.....105	13321-18.....108	13421-03.....114	13479-25.....119/2	13622-24.....128/1
13230-12.....105	13321-20.....108	13421-04.....114	13479-28.....119/2	13622-26.....128/1
13230-14.....105	13321-22.....108	13421-05.....114	13480-15.....119/2	13622-30.....128/1
13230-18.....105	13321-24.....108	13421-06.....114	13480-18.....119/2	13623-24.....128/1
13230-21.....105	13321-26.....108	13421-07.....114	13481-15.....119/2	13623-26.....128/1
13231-12.....105	13321-30.....108	13422-00.....114	13481-18.....119/2	13623-30.....128/1
13231-14.....105	13322-14.....108	13422-01.....114	13491-19.....119/2	13702-14.....129
13231-18.....105	13322-16.....108	13422-02.....114	13493-23.....120	13704-16.....129
13231-21.....105	13323-14.....108	13422-03.....114	13495-18.....120	13704-18.....129
13232-12.....105	13323-16.....108	13422-06.....114	13497-20.....120	13710-15.....129
13233-12.....105	13330-13.....109	13425-02.....114	13499-16.....120	13710-18.....129
13240-14.....106	13330-15.....109	13425-03.....114	13501-23.....120	13710-20.....129
13240-18.....106	13330-18.....109	13425-04.....114	13503-21.....121	13712-15.....129
13241-14.....106	13330-20.....109	13425-05.....114	13505-21.....121	13712-18.....129
13241-18.....106	13331-13.....109	13425-06.....114	13507-22.....121	13712-20.....129
13242-16.....106	13331-15.....109	13428-21.....115	13507-23.....121	13720-18.....130
13243-16.....106	13331-18.....109	13431-13.....115	13513-23.....122	13730-16.....131
13244-14.....106	13331-20.....109	13431-16.....115	13515-23.....122	15101-09.....132
13245-14.....106	13340-16.....109	13431-18.....115	13517-23.....122	15103-07.....132
13250-14.....107	13340-20.....109	13431-20.....115	13519-20.....122	15103-09.....132
13250-18.....107	13341-16.....109	13431-23.....115	13519-22.....122	15105-09.....132
13251-14.....107	13341-20.....109	13431-25.....115	13519-24.....122	15107-10.....132
13251-18.....107	13345-12.....109	13431-28.....115	13520-23.....122	15107-13.....132
13254-14.....107	13345-14.....109	13432-19.....116	13520-24.....122	15108-14.....132
13255-14.....107	13350-16.....109	13433-19.....116	13523-23.....123	15111-09.....132
13256-14.....106	13350-20.....109	13434-28.....116	13551-14.....123	15111-11.....132
13257-14.....106	13351-16.....109	13435-28.....116	13551-18.....123	15111-13.....132
13258-16.....106	13351-20.....109	13438-01.....116	13551-20.....123	15111-15.....132
13259-16.....106	13356-15.....109	13438-02.....116	13554-21.....123	15115-11.....132
13260-14.....107	13358-15.....109	13438-03.....116	13555-21.....123	15117-13.....132
13261-14.....107	13358-20.....109	13438-04.....116	13556-24.....123	15121-11.....133
13262-16.....107	13360-15.....110	13441-01.....117	13561-20.....123	15121-13.....133
13263-16.....107	13364-14.....110	13441-02.....117	13563-20.....123	15123-11.....133
13264-16.....107	13366-19.....110	13441-03.....117	13564-20.....123/1	15123-13.....133
13265-16.....107	13368-14.....110	13441-04.....117	13565-20.....123/2	15125-14.....133
13270-14.....106	13368-16.....110	13442-21.....117	13565-25.....123/2	15140-16.....133
13271-14.....106	13370-13.....110	13442-26.....117	13570-23.....124	15150-19.....133
13310-13.....108	13372-13.....110	13443-21.....117	13571-25.....124	15161-18.....133
13310-14.....108	13374-14.....110	13443-26.....117	13573-22.....124	15164-15.....133
13310-16.....108	13376-16.....110	13444-21.....117	13574-24.....125	15164-20.....133
13310-18.....108	13377-25.....111	13444-26.....117	13575-24.....125	17110-20.....134
13310-20.....108	13377-26.....111	13445-21.....117	13579-21.....125	17110-25.....134
13310-22.....108	13380-15.....111	13445-26.....117	13580-60.....126	17111-20.....134

17111-25.....134	19152-64.....142	19196-04.....148/1	19250-24.....153	19314-20.....159
17112-20.....134	19158-51.....142	19196-05.....148/1	19270-02.....153	19315-06.....159
17112-25.....134	19158-64.....142	19196-06.....148/1	19270-03.....153	19315-21.....159
17113-20.....134	19158-76.....142	19210-12.....148/2	19270-04.....153	19317-21.....159
17113-25.....134	19158-82.....142	19211-12.....148/2	19270-06.....153	19318-40.....159
17120-28.....134	19159-50.....142	19212-01.....148/2	19271-02.....153	19318-57.....159
17121-28.....134	19159-64.....142	19212-02.....148/2	19271-03.....153	19318-78.....159
17131-21.....134	19159-70.....142	19214-13.....148/2	19271-04.....153	19330-40.....158
17133-17.....135	19159-90.....142	19214-18.....148/2	19271-06.....153	19330-55.....158
17160-22.....135	19160-17.....143	19215-01.....149	19280-01.....154	19332-19.....160
17160-25.....135	19161-17.....143	19215-02.....149	19280-02.....154	19332-21.....160
17161-22.....135	19162-10.....143	19215-03.....149	19280-03.....154	19340-10.....160
17161-25.....135	19162-13.....143	19215-13.....148/2	19280-04.....154	19340-15.....160
17170-18.....136	19168-06.....143/1	19215-18.....148/2	19280-06.....154	19340-20.....160
17170-20.....136	19168-08.....143/1	19216-01.....149	19281-01.....154	19344-14.....160
17170-25.....136	19168-10.....143/1	19216-02.....149	19281-02.....154	19344-20.....160
17170-30.....136	19168-12.....143/1	19216-05.....149	19281-03.....154	19344-26.....160
17171-18.....136	19168-17.....143/1	19216-07.....149	19281-04.....154	19345-01.....160
17171-20.....136	19168-20.....143/1	19216-10.....149	19281-06.....154	19345-02.....160
17171-25.....136	19168-25.....143/1	19217-03.....149	19282-02.....154	19345-03.....160
17172-18.....136	19169-25.....143/1	19217-05.....149	19282-03.....154	19348-22.....160
17172-25.....136	19170-20.....143/1	19217-07.....149	19282-04.....154	19350-35.....161
17173-18.....136	19170-25.....143/1	19220-01.....150	19282-06.....154	19350-60.....161
17173-25.....136	19170-32.....143/1	19220-02.....150	19296-01.....155	19350-70.....161
17174-25.....136	19170-40.....143/1	19220-03.....150	19296-02.....155	19360-04.....162
17175-25.....136	19170-45.....143/1	19220-04.....150	19296-03.....155	19364-40.....162
17180-18.....136	19170-50.....143/1	19221-01.....150	19296-04.....155	19364-50.....162
17180-25.....136	19170-65.....143/1	19221-02.....150	19296-06.....155	19364-60.....162
17207-13.....137	19170-76.....143/1	19221-03.....150	19296-08.....155	19364-70.....162
17210-13.....137	19171-30.....143/2	19221-04.....150	19297-01.....155	19366-08.....162
17210-16.....137	19171-40.....143/2	19226-02.....150	19297-02.....155	19367-08.....162
17210-18.....137	19171-50.....143/2	19226-03.....150	19297-03.....155	19370-40.....163
17220-25.....137	19171-60.....143/2	19226-04.....150	19297-04.....155	19370-50.....163
17226-25.....137	19171-70.....143/2	19227-02.....150	19297-06.....155	19370-60.....163
17227-25.....137	19172-30.....143/3	19227-03.....150	19297-08.....155	19370-75.....163
17229-25.....137	19173-20.....143/3	19227-04.....150	19298-01.....156	19370-85.....163
17230-26.....138	19173-30.....143/3	19229-02.....150	19299-01.....156	19372-22.....163
17231-26.....138	19173-40.....143/3	19229-03.....150	19300-02.....156	19374-45.....163
17233-26.....138	19174-17.....143/3	19230-10.....151	19300-03.....156	19374-55.....163
19102-12.....139	19174-25.....143/3	19230-12.....151	19300-04.....156	19374-65.....163
19102-15.....139	19174-37.....143/3	19230-14.....151	19300-06.....156	19378-25.....163
19104-15.....139	19174-40.....143/3	19230-16.....151	19301-02.....156	19380-35.....163
19110-13.....139	19175-28.....143/3	19230-18.....151	19301-03.....156	19380-50.....163
19110-18.....139	19176-25.....143/4	19231-11.....151	19301-04.....156	19381-50.....163
19120-00.....139	19177-27.....143/4	19231-13.....151	19301-06.....156	19382-50.....163
19120-14.....139	19178-28.....143/4	19231-15.....151	19302-01.....157	19385-38.....164
19120-15.....139	19179-28.....144	19232-08.....151	19302-02.....157	19385-57.....164
19120-17.....139	19180-19.....145	19232-10.....151	19302-03.....157	19388-40.....164
19122-13.....140	19181-22.....145	19232-12.....151	19302-04.....157	19388-50.....164
19123-11.....140	19181-25.....145	19232-14.....151	19302-05.....157	19388-65.....164
19124-15.....140	19183-25.....145	19232-16.....151	19302-06.....157	19400-01.....165
19125-14.....140	19185-25.....145	19232-18.....151	19304-19.....157	19400-02.....165
19126-13.....140	19187-25.....145	19233-08.....152	19306-20.....157	19400-03.....165
19127-11.....140	19187-38.....146	19233-11.....152	19307-01.....157	19480-22.....164
19131-21.....141	19187-50.....146	19233-15.....152	19307-02.....157	19480-27.....164
19132-15.....141	19187-75.....146	19233-17.....152	19310-01.....158	19482-45.....164
19134-20.....141	19189-25.....146	19233-20.....152	19310-02.....158	19482-73.....164
19135-19.....141	19189-38.....146	19233-23.....152	19310-03.....158	19482-82.....164
19136-20.....141	19189-50.....146	19234-20.....153	19310-04.....158	19484-01.....164
19137-16.....141	19189-75.....146	19235-21.....153	19310-05.....158	19484-02.....164
19140-00.....142	19190-64.....147	19236-01.....153	19312-01.....158	19490-22.....166
19140-01.....142	19191-25.....147	19236-02.....153	19312-02.....158	19490-43.....166
19140-02.....142	19191-40.....147	19236-08.....152	19312-03.....158	19490-65.....166
19150-01.....142	19191-62.....147	19236-10.....152	19312-04.....158	19492-25.....164
19150-02.....142	19192-23.....147	19236-12.....152	19312-05.....158	19493-80.....167
19150-03.....142	19195-01.....148	19236-14.....152	19314-07.....159	19494-00.....167
19150-04.....142	19195-02.....148	19236-16.....152	19314-10.....159	19494-12.....167
19152-25.....142	19195-03.....148	19236-18.....152	19314-12.....159	19494-13.....167
19152-31.....142	19196-01.....148/1	19240-10.....153	19314-14.....159	19494-14.....167
19152-38.....142	19196-02.....148/1	19240-20.....153	19314-15.....159	19494-16.....167
19152-51.....142	19196-03.....148/1	19250-16.....153	19314-16.....159	19494-18.....167

19494-45.....166	19688-01.....175	19771-01.....185	19825-06.....193/194	21115-10.....199
19494-60.....166	19688-02.....175	19771-02.....185	19826-06.....193/194	21120-16.....199
19494-75.....166	19689-01.....175/1	19771-03.....185	19831-25.....193/194	21121-14.....199
19495-60.....167	19689-02.....175/1	19772-00.....185	19833-33.....193/194	21121-18.....199
19495-80.....167	19690-31.....176	19772-03.....185	19834-01.....193/194	21122-13.....199
19496-00.....167	19692-32.....176	19780-01.....186	19902-10.....267	21122-18.....199
19496-12.....167	19694-01.....177	19781-55.....185/187	19903-00.....267	21125-01.....200
19496-14.....167	19694-02.....177	19781-65.....185/187	19910-00.....196	21125-02.....200
19496-50.....166	19694-03.....177	19782-00.....185	19911-00.....196	21125-03.....200
19497-14.....167	19696-18.....178	19783-00.....187	19912-50.....196	21125-04.....200
19498-01.....167	19698-18.....178	19783-01.....187	19912-70.....196	21150-00.....201
19498-02.....167	19710-00.....178/1	19783-24.....185	19913-50.....196	21150-02.....201
19498-03.....167	19710-01.....178/1, 178/2	19784-00.....187/1	19913-70.....196	21150-03.....201
19610-07.....168	19710-40.....178/1, 178/3	19784-30.....187/1	19914-41.....196	21150-06.....201
19611-07.....168	19710-45.....178/1, 178/3	19784-40.....187/1	19914-67.....196	21150-09.....201
19620-07.....168	19710-50.....178/1, 178/3	19784-50.....187/1	19915-48.....196	21150-12.....201
19620-10.....168	19710-55.....178/1, 178/3	19784-60.....187/1	19915-64.....196	21150-15.....201
19621-07.....168	19710-60.....178/1, 178/3	19784-78.....187/1	19916-64.....196	21150-80.....201
19621-10.....168	19711-00.....178/3	19784-80.....187/1	19916-80.....196	21150-90.....201
19621-07.....168	19711-01.....178/3, 178/4	19784-98.....187/1	19917-64.....196	21154-01.....202
19630-10.....168	19711-40.....178/2, 178/4	19784-99.....187/1	19918-64.....196	21154-02.....202
19631-10.....168	19711-45.....178/2, 178/4	19790-01.....186	19918-88.....196	21154-03.....202
19634-10.....168	19711-50.....178/2, 178/4	19790-02.....186	19960-01.....197	21154-04.....202
19635-10.....168	19711-55.....178/2, 178/4	19795-01.....188	19960-02.....197	21154-05.....202
19636-14.....168	19711-60.....178/2, 178/4	19795-02.....188	19960-03.....197	21154-06.....202
19637-14.....168	19712-00.....178/2	19798-01.....188	19960-04.....197	21160-04.....202
19640-14.....169	19713-00.....178/4	19798-02.....188	19960-05.....197	21160-06.....202
19641-14.....169	19721-00.....179	19798-03.....188	19960-06.....197	21160-07.....202
19650-10.....169	19721-15.....179	19798-04.....188	19970-01.....198	21160-08.....202
19651-10.....169	19726-01.....179	19799-03.....189	19980-01.....197	21160-10.....202
19654-13.....169	19738-45.....179	19799-04.....189	19980-02.....197	21160-12.....202
19655-13.....169	19738-50.....179	19799-05.....189	19980-03.....197	21160-14.....202
19670-14.....169	19738-55.....179	19799-06.....189	19980-04.....197	21162-12.....202
19670-16.....169	19738-60.....179	19800-01.....189/1	19980-05.....197	21190-14.....203
19670-20.....169	19738-65.....179	19800-02.....189/1	19980-06.....197	21270-12.....203
19670-24.....169	19744-00.....180	19800-03.....189/1	19980-18.....198	21270-14.....203
19671-14.....169	19744-17.....180	19800-04.....189/1	19990-18.....198	21270-16.....203
19671-16.....169	19745-40.....180	19802-09.....189/1	19995-22.....198	21270-18.....203
19671-20.....169	19745-45.....180	19802-11.....189/1	19995-38.....198	21270-23.....203
19671-24.....169	19745-50.....180	19802-14.....189/1	19998-03.....198	21272-12.....203
19672-11.....171	19745-55.....180	19802-16.....189/1	19998-05.....198	21272-14.....203
19673-11.....171	19745-60.....180	19802-18.....189/1	21102-11.....199	21272-16.....203
19674-15.....171	19745-65.....180	19803-14.....189/1	21102-13.....199	21272-18.....203
19675-00.....170	19745-70.....180	19804-18.....189/2	21102-14.....199	21272-23.....203
19675-13.....171	19748-01.....180	19805-18.....189/2	21102-16.....199	21290-12.....203
19676-00.....170	19748-02.....180	19806-18.....189/2	21102-18.....199	21290-14.....203
19677-13.....171	19748-03.....180	19810-22.....190	21102-20.....199	21290-16.....203
19677-19.....170	19748-04.....180	19812-60.....190	21102-25.....199	21290-18.....203
19677-25.....170	19754-00.....181	19813-00.....191	21104-11.....199	21292-12.....203
19677-32.....170	19758-85.....181	19816-00.....191	21104-13.....199	21292-14.....203
19678-05.....170	19759-00.....181	19820-02.....193/195	21104-14.....199	21292-16.....203
19678-06.....170	19760-14.....181	19820-03.....193/195	21104-16.....199	21292-18.....203
19678-16.....171	19762-16.....181	19820-10.....193/195	21104-18.....199	21310-15.....203
19679-20.....172	19764-18.....182	19820-20.....193/194	21104-20.....199	21320-12.....203
19679-22.....172	19764-20.....182	19820-90.....192/193	21104-25.....199	21320-18.....203
19680-19.....172	19764-25.....182	19820-91.....192/193	21106-11.....199	21331-25.....203
19681-19.....172	19765-01.....183	19820-99.....193	21106-13.....199	21340-45.....203
19681-21.....172	19765-02.....183	19821-01.....193/195	21106-14.....199	23104-00.....204
19682-26.....173	19765-03.....183	19821-02.....193/195	21106-16.....199	23110-30.....204
19683-26.....173	19765-04.....183	19821-03.....193/195	21106-18.....199	23110-35.....204
19684-14.....173	19766-90.....182	19821-04.....193/195	21106-20.....199	23110-40.....204
19684-16.....173	19767-01.....184	19822-01.....193	21106-25.....199	23110-45.....204
19684-20.....173	19767-02.....184	19822-02.....193	21108-14.....199	23110-50.....204
19684-26.....173	19767-18.....184	19822-21.....194	21109-18.....199	23110-55.....204
19685-14.....173	19767-25.....184	19822-22.....194	21110-13.....199	23110-60.....204
19685-16.....173	19770-01.....186	19822-22L.....194	21110-14.....199	23123-30.....204
19685-20.....173	19770-02.....186	19822-23.....193	21110-16.....199	23123-40.....204
19685-26.....173	19770-03.....186	19822-24.....193	21110-18.....199	23123-50.....204
19686-32.....174	19770-04.....186	19822-25.....193/194	21110-20.....199	23125-11.....204
19687-01.....175	19770-05.....186	19822-26.....193/194	21111-14.....199	23128-19.....204
19687-02.....175	19771-00.....185	19824-06.....193/194	21112-14.....199	23140-02.....204

23150-10.....205	25180-12.....209	25408-12.....212	25721-14.....217	27413-05.....222
23150-12.....205	25180-14.....209	25410-14.....212	25722-14.....217	27413-06.....222
23150-14.....205	25180-16.....209	25410-17.....212	25723-14.....217	27413-07.....222
23150-16.....205	25180-18.....209	25414-14.....212	25730-18.....217	27413-08.....222
23150-18.....205	25180-20.....209	25414-17.....212	25731-18.....217	27413-09.....222
23150-20.....205	25180-24.....209	25414-18.....212	27109-20.....218	27413-10.....222
23170-25.....205	25180-26.....209	25415-14.....212	27110-21.....218	27413-11.....222
23170-30.....205	25180-30.....209	25415-17.....212	27110-24.....218	27413-12.....222
23170-33.....205	25184-12.....209	25415-20.....212	27110-27.....218	27413-13.....222
23170-35.....205	25184-14.....209	25430-16.....212	27111-21.....218	27413-14.....222
23181-40.....205	25184-16.....209	25434-11.....212	27111-24.....218	27413-15.....222
23195-08.....207	25184-18.....209	25434-13.....212	27111-27.....218	27413-16.....222
23195-10.....207	25184-20.....209	25434-16.....212	27120-21.....218	27423-01.....222
23195-12.....207	25184-24.....209	25436-13.....212	27120-24.....218	27423-02.....222
23195-14.....207	25184-26.....209	25438-13.....212	27120-27.....218	27423-03.....222
23195-16.....207	25184-30.....209	25438-15.....213	27121-21.....218	27423-04.....222
23195-18.....207	25190-16.....209	25446-25.....213	27121-24.....218	27423-05.....222
23197-08.....207	25190-18.....209	25447-25.....213	27121-27.....218	27423-06.....222
23197-10.....207	25190-20.....209	25450-14.....213	27130-13.....219	27423-07.....222
23197-12.....207	25194-16.....209	25450-17.....213	27131-13.....219	27423-08.....222
23197-14.....207	25194-18.....209	25450-20.....213	27133-24.....219	27423-09.....222
23197-16.....207	25194-20.....209	25450-24.....213	27134-32.....219	27423-10.....222
23197-18.....207	25196-13.....209	25452-14.....213	27135-24.....219	27423-11.....222
23198-08.....207	25196-18.....209	25452-17.....213	27139-19.....219	27423-12.....222
23198-10.....207	25214-16.....210	25452-20.....213	27201-15.....220	27423-13.....222
23198-12.....207	25214-18.....210	25452-24.....213	27201-19.....220	27423-14.....222
23198-14.....207	25214-20.....210	25460-18.....213	27201-21.....220	27423-15.....222
23198-16.....207	25214-23.....210	25460-20.....213	27202-15.....220	27423-16.....222
23198-18.....207	25214-26.....210	25460-23.....213	27202-19.....220	27433-01.....222
23210-00.....206	25214-31.....210	25465-20.....213	27202-21.....220	27433-02.....222
23250-20.....206	25224-13.....210	25465-25.....213	27203-15.....220	27433-03.....222
23250-40.....206	25224-15.....210	25466-17.....213	27203-19.....220	27433-04.....222
23302-01.....206	25224-18.....210	25466-20.....213	27203-21.....220	27433-05.....222
23302-02.....206	25224-20.....210	25467-17.....213	27204-15.....220	27433-06.....222
23302-03.....206	25224-23.....210	25467-20.....213	27204-19.....220	27433-07.....222
23302-04.....206	25224-26.....210	25610-11.....214	27204-21.....220	27433-08.....222
23302-05.....206	25225-13.....210	25612-13.....214	27240-00.....220	27433-09.....222
23302-06.....206	25225-15.....210	25612-15.....214	27240-01.....220	27433-10.....222
23302-07.....206	25225-18.....210	25614-12.....214	27240-02.....220	27433-11.....222
23302-08.....206	25225-20.....210	25615-12.....214	27240-03.....220	27433-12.....222
23310-14.....206	25225-23.....210	25620-16.....214	27271-19.....221	27433-13.....222
23310-18.....206	25225-26.....210	25621-16.....214	27273-19.....221	27433-14.....222
25110-12.....208	25230-18.....210	25624-16.....214	27275-30.....221	27433-15.....222
25114-12.....208	25230-20.....210	25625-16.....214	27277-25.....221	27433-16.....222
25120-12.....208	25230-23.....210	25627-14.....214	27285-20.....221/1	27434-01.....222
25122-12.....208	25241-21.....210	25628-14.....214	27288-22.....221/1	27434-02.....222
25128-13.....208	25241-26.....210	25650-10.....216	27289-22.....221/1	27434-03.....222
25129-13.....208	25245-21.....210	25651-10.....216	27291-18.....221/1	27434-04.....222
25130-13.....208	25245-26.....210	25656-10.....216	27291-27.....221/1	27434-05.....222
25134-13.....208	25250-27.....210	25657-10.....216	27297-23.....221/1	27434-06.....222
25136-11.....208	25254-27.....210	25660-13.....217	27298-23.....221/1	27434-07.....222
25137-11.....208	25260-27.....210	25661-13.....217	27403-01.....222	27434-08.....222
25138-11.....208	25264-27.....210	25667-18.....215	27403-02.....222	27434-09.....222
25140-13.....208	25285-20.....211	25667-21.....215	27403-03.....222	27434-10.....222
25144-13.....208	25285-24.....211	25668-18.....215	27403-04.....222	27434-11.....222
25146-13.....208	25285-26.....211	25668-21.....215	27403-05.....222	27434-12.....222
25148-13.....208	25290-18.....211	25670-14.....215	27403-06.....222	27434-13.....222
25150-12.....208	25292-18.....211	25671-14.....215	27403-07.....222	27434-14.....222
25150-14.....208	25293-27.....211	25672-14.....215	27403-08.....222	27434-15.....222
25154-12.....208	25311-20.....211	25673-14.....215	27403-09.....222	27434-16.....222
25154-14.....208	25311-27.....211	25676-14.....215	27403-10.....222	27441-01.....223
25160-15.....209	25315-20.....211	25677-14.....215	27403-11.....222	27441-02.....223
25160-18.....209	25315-27.....211	25678-09.....215	27403-12.....222	27441-03.....223
25160-20.....209	25324-18.....211	25678-14.....216	27403-13.....222	27441-04.....223
25160-23.....209	25324-26.....211	25679-09.....215	27403-14.....222	27441-05.....223
25164-15.....209	25330-21.....212	25679-14.....216	27403-15.....222	27441-06.....223
25164-18.....209	25330-23.....212	25680-13.....215	27403-16.....222	27441-07.....223
25164-20.....209	25334-23.....212	25684-13.....215	27413-01.....222	27441-08.....223
25164-23.....209	25405-12.....212	25700-18.....217	27413-02.....222	27441-09.....223
25170-15.....209	25406-12.....212	25701-18.....217	27413-03.....222	27441-10.....223
25174-15.....209	25407-12.....212	25720-14.....217	27413-04.....222	27441-11.....223

27441-12.....	223	29150-12.....	227	31350-28.....	232	33259-23.....	240	33416-17.....	248
27443-01.....	223	29152-14.....	227	31360-30.....	232	33260-24.....	240	33417-18.....	248
27443-02.....	223	31101-24.....	229	31362-28.....	232	33261-22.....	240	33418-17.....	248
27443-03.....	223	31103-23.....	229	31366-23.....	232	33274-14.....	241	33419-20.....	248
27443-04.....	223	31103-26.....	229	31370-20.....	233	33274-17.....	241	33420-20.....	249
27443-05.....	223	31103-37.....	229	31380-18.....	233	33274-19.....	241	33421-20.....	249
27443-10.....	223	31120-19.....	229	31390-18.....	233	33274-22.....	241	33423-23.....	249
27443-20.....	223	31130-14.....	229	31395-18.....	233	33275-14.....	241	33424-10.....	249
27443-30.....	223	31200-39.....	230/4	31397-24.....	233	33275-17.....	241	33441-13.....	249
27450-01.....	223	31200-58.....	230/4	33100-01.....	234	33275-19.....	241	33441-18.....	249
27450-02.....	223	31200-95.....	230/18	33100-02.....	234	33275-22.....	241	33441-20.....	249
27450-03.....	223	31200-98.....	230/4	33101-12.....	234	33280-15.....	241	33442-19.....	249
27450-04.....	223	31200-99.....	230/4	33101-14.....	234	33281-15.....	241	33443-18.....	249
27450-05.....	223	31201-01.....	230	33102-01.....	234	33282-19.....	241	33444-15.....	250
27450-06.....	223	31201-02.....	230	33102-02.....	234	33283-17.....	241	33450-01.....	250
27452-01.....	223	31201-11.....	230/2	33103-14.....	235	33284-15.....	241	33450-02.....	250
27452-02.....	223	31201-22.....	230/2	33105-17.....	235	33286-18.....	241	33467-97.....	251
27452-03.....	223	31201-39.....	230/4	33107-16.....	235	33289-18.....	241	33467-98.....	251
27452-04.....	223	31201-45.....	230/7	33109-16.....	235	33290-23.....	242	33468-00.....	251
27452-05.....	223	31201-58.....	230/4	33115-15.....	236	33290-27.....	242	33468-01.....	251
27452-06.....	223	31201-70.....	230/7	33117-15.....	236	33291-23.....	242	33468-02.....	251
27465-10.....	223	31202-00.....	230/7	33119-15.....	236	33291-27.....	242	33468-03.....	251
27465-20.....	223	31202-14.....	230/18	33131-15.....	236	33292-26.....	242	33468-04.....	251
27467-01.....	223	31202-16.....	230/18	33133-15.....	236	33293-27.....	242	33469-96.....	251
27467-02.....	223	31203-00.....	230/5	33136-17.....	236	33295-24.....	242	33469-97.....	251
27467-03.....	223	31203-10.....	230/5	33137-17.....	236	33300-21.....	243	33469-98.....	251
27467-04.....	223	31203-20.....	230/5	33142-20.....	236	33362-21.....	243	33470-00.....	251
27467-05.....	223	31203-30.....	230/5	33143-20.....	236	33365-19.....	243	33470-01.....	251
27475-10.....	223	31203-50.....	230/17	33147-20.....	237	33366-19.....	243	33470-02.....	251
27475-20.....	223	31204-00.....	230/5	33148-18.....	237	33366-23.....	243	33470-03.....	251
27477-01.....	223	31204-01.....	230/15	33150-16.....	237	33366-26.....	243	33470-04.....	251
27477-02.....	223	31204-02.....	230/15	33151-16.....	237	33368-26.....	243	33470-05.....	251
27477-03.....	223	31204-03.....	230/15	33152-17.....	237	33370-22.....	244	33470-06.....	251
27477-04.....	223	31204-04.....	230/15	33153-17.....	237	33370-27.....	244	33471-96.....	251
27477-05.....	223	31204-10.....	230/5	33154-18.....	237	33370-30.....	244	33471-97.....	251
27485-10.....	223	31204-20.....	230/5	33155-18.....	237	33372-22.....	244	33471-98.....	251
27485-20.....	223	31204-30.....	230/5	33156-18.....	237	33372-26.....	244	33472-00.....	251
27487-01.....	223	31205-00.....	230/6	33157-02.....	237	33372-33.....	244	33472-01.....	251
27487-02.....	223	31205-08.....	230/16	33157-03.....	237	33378-15.....	244	33472-02.....	251
27487-03.....	223	31205-09.....	230/16	33157-04.....	238	33378-17.....	244	33472-03.....	251
27487-04.....	223	31205-20.....	230/16	33157-05.....	238	33378-21.....	244	33472-04.....	251
27487-05.....	223	31205-21.....	230/16	33157-06.....	238	33380-15.....	244	33472-05.....	251
27610-12.....	224	31210-10.....	230/6	33158-03.....	238	33380-17.....	244	33472-06.....	251
27612-12.....	224	31210-21.....	230/10	33158-04.....	238	33380-21.....	244	33473-01.....	252
27614-12.....	224	31210-22.....	230/10	33158-05.....	238	33382-33.....	244	33473-02.....	252
27616-12.....	224	31210-30.....	230/18	33159-03.....	238	33382-45.....	244	33473-03.....	252
27620-18.....	224	31210-45.....	230/14	33159-04.....	238	33384-33.....	244	33473-04.....	252
27630-12.....	224	31210-50.....	230/14	33159-05.....	238	33384-45.....	244	33473-05.....	252
27640-13.....	224	31210-65.....	230/14	33201-18.....	238	33391-15.....	245	33473-06.....	252
27642-14.....	224	31211-45.....	230/14	33202-18.....	238	33391-19.....	245	33474-96.....	251
27660-07.....	224	31211-50.....	230/14	33205-18.....	238	33391-24.....	245	33474-97.....	251
27660-11.....	224	31211-65.....	230/14	33211-15.....	238	33391-26.....	245	33474-98.....	251
27660-12.....	224	31212-02.....	230/18	33213-15.....	238	33391-28.....	245	33475-00.....	251
27660-14.....	224	31212-50.....	230/14	33216-18.....	239	33395-17.....	245	33475-01.....	251
27660-16.....	224	31212-65.....	230/14	33217-18.....	239	33395-25.....	245	33475-02.....	251
27660-18.....	224	31220-21.....	230/12	33219-23.....	239	33395-26.....	245	33475-03.....	251
27660-20.....	224	31220-22.....	230/12	33220-20.....	239	33395-27.....	245	33475-04.....	251
27660-22.....	224	31220-99.....	230/18	33230-22.....	239	33402-17.....	246	33475-05.....	251
27680-00.....	226	31250-00.....	231	33230-26.....	239	33404-20.....	246	33475-06.....	251
29102-16.....	227	31250-10.....	231/1	33231-22.....	239	33405-20.....	246	33476-01.....	253
29102-20.....	227	31250-12.....	231/1	33231-26.....	239	33406-20.....	246	33476-02.....	253
29102-24.....	227	31250-13.....	231/1	33235-23.....	239	33407-19.....	246	33476-03.....	253
29110-17.....	227	31250-14.....	231/1	33237-23.....	239	33409-13.....	246	33476-98.....	253
29120-20.....	227	31250-15.....	231/1	33241-30.....	240	33410-19.....	246	33476-99.....	253
29120-28.....	227	31252-11.....	231	33243-30.....	240	33412-16.....	247	33477-00.....	253
29121-20.....	227	31252-22.....	231	33245-23.....	240	33412-24.....	247	33477-01.....	253
29121-28.....	227	31253-00.....	231	33247-23.....	240	33413-14.....	247	33477-02.....	253
29130-23.....	227	31253-11.....	231	33251-26.....	240	33414-21.....	247	33477-03.....	253
29140-20.....	227	31254-10.....	231	33253-26.....	240	33415-23.....	248	33477-04.....	253
29140-30.....	227	31254-11.....	231	33257-23.....	240	33415-25.....	248	33477-05.....	253
29145-55.....	227	31254-12.....	231	33258-23.....	240	33415-28.....	248	33477-06.....	253

33478-98.....	253	33492-20.....	257	33622-04.....	259	33645-09.....	261	33661-07.....	263
33478-99.....	253	33494-13.....	257	33622-05.....	259	33645-13.....	261	33661-10.....	263
33479-00.....	253	33494-14.....	257	33622-06.....	259	33645-16.....	261	33661-15.....	263
33479-01.....	253	33494-17.....	257	33622-07.....	259	33645-19.....	261	33661-20.....	263
33479-02.....	253	33495-16.....	257	33622-08.....	259	33645-25.....	261	33661-25.....	263
33479-03.....	253	33496-00.....	257	33623-02.....	259	33645-32.....	261	33661-30.....	263
33479-04.....	253	33496-01.....	257	33623-03.....	259	33647-06.....	261	33664-04.....	263
33479-05.....	253	33496-12.....	257	33623-04.....	259	33647-09.....	261	33664-06.....	263
33479-06.....	253	33497-00.....	257	33623-05.....	259	33647-14.....	261	33664-08.....	263
33480-97.....	254	33498-00.....	257	33623-06.....	259	33647-16.....	261	33664-10.....	263
33480-98.....	254	33498-01.....	257	33623-07.....	259	33647-19.....	261	33664-12.....	263
33481-00.....	254	33498-12.....	257	33623-08.....	259	33647-25.....	261	33665-04.....	263
33481-01.....	254	33500-01.....	256	33625-02.....	259	33647-32.....	261	33665-06.....	263
33481-02.....	254	33500-02.....	256	33625-03.....	259	33649-09.....	261	33665-08.....	263
33481-03.....	254	33500-03.....	256	33625-04.....	259	33649-14.....	261	33665-10.....	263
33481-04.....	254	33509-03.....	258	33625-05.....	259	33649-16.....	261	33665-12.....	263
33481-05.....	254	33509-05.....	258	33625-06.....	259	33649-19.....	261	33665-24.....	264
33481-06.....	254	33509-08.....	258	33625-07.....	259	33649-25.....	261	33665-26.....	264
33482-01.....	253	33510-12.....	258	33625-08.....	259	33649-32.....	261	33665-55.....	264
33482-02.....	253	33510-14.....	258	33626-25.....	260	33650-04.....	261	33665-90.....	264
33482-03.....	253	33510-16.....	258	33626-35.....	260	33650-06.....	261	33666-22.....	264
33482-97.....	254	33600-02.....	259	33627-04.....	260	33650-08.....	261	33668-03.....	265
33482-98.....	254	33600-03.....	259	33627-06.....	260	33650-10.....	261	33668-05.....	265
33483-00.....	254	33600-04.....	259	33628-03.....	260	33650-13.....	261	33668-06.....	265
33483-01.....	254	33600-05.....	259	33628-05.....	260	33650-16.....	261	33668-08.....	265
33483-02.....	254	33600-06.....	259	33630-06.....	260	33650-18.....	261	33668-09.....	265
33483-03.....	254	33600-08.....	259	33630-08.....	260	33650-20.....	261	33668-13.....	265
33483-04.....	254	33600-09.....	259	33630-10.....	260	33650-25.....	261	33668-16.....	265
33483-05.....	254	33600-10.....	259	33630-12.....	260	33650-30.....	261	33668-19.....	265
33483-06.....	254	33602-04.....	259	33630-15.....	260	33650-38.....	261	33669-05.....	264
33484-97.....	254	33602-06.....	259	33630-20.....	260	33650-44.....	261	33669-10.....	264
33484-98.....	254	33602-08.....	259	33630-25.....	260	33650-50.....	261	33669-15.....	264
33485-00.....	254	33602-10.....	259	33630-30.....	260	33651-04.....	261	33670-05.....	264
33485-01.....	254	33602-12.....	259	33631-10.....	260	33651-06.....	261	33670-06.....	265
33485-02.....	254	33602-14.....	259	33631-12.....	260	33651-08.....	261	33670-09.....	265
33485-03.....	254	33602-16.....	259	33631-15.....	260	33651-10.....	261	33670-10.....	264
33485-04.....	254	33604-04.....	259	33631-20.....	260	33651-13.....	261	33670-13.....	265
33485-05.....	254	33604-06.....	259	33631-25.....	260	33651-16.....	261	33670-15.....	264
33485-06.....	254	33604-08.....	259	33631-30.....	260	33651-18.....	261	33670-16.....	265
33485-21.....	255	33604-10.....	259	33632-06.....	260	33651-20.....	261	33670-19.....	265
33485-99.....	255	33604-12.....	259	33632-08.....	260	33651-25.....	261	33670-25.....	265
33486-00.....	255	33604-14.....	259	33632-10.....	260	33651-30.....	261	33670-32.....	265
33486-01.....	255	33604-16.....	259	33632-12.....	260	33651-38.....	261	33671-06.....	265
33486-02.....	255	33605-04.....	259	33632-15.....	260	33651-44.....	261	33671-09.....	265
33486-99.....	255	33605-06.....	259	33632-20.....	260	33651-50.....	261	33671-13.....	265
33487-00.....	255	33605-08.....	259	33632-25.....	260	33652-02.....	262	33671-16.....	265
33487-01.....	255	33605-10.....	259	33632-25.....	260	33652-03.....	262	33671-19.....	265
33487-02.....	255	33605-12.....	259	33633-06.....	260	33652-04.....	262	33671-25.....	265
33487-99.....	255	33605-14.....	259	33633-08.....	260	33652-06.....	262	33671-32.....	265
33488-00.....	255	33605-16.....	259	33633-10.....	260	33652-08.....	262	33672-06.....	265
33488-01.....	255	33610-04.....	259	33633-12.....	260	33652-10.....	262	33672-09.....	265
33488-02.....	255	33610-06.....	259	33633-15.....	260	33652-12.....	262	33672-13.....	265
33489-00.....	255	33610-08.....	259	33633-20.....	260	33652-15.....	262	33672-16.....	265
33489-01.....	255	33610-10.....	259	33633-25.....	260	33654-02.....	262	33672-19.....	265
33489-02.....	255	33610-12.....	259	33633-30.....	260	33654-03.....	262	33672-25.....	265
33489-03.....	255	33610-14.....	259	33634-06.....	260	33654-04.....	262	33672-32.....	265
33490-10.....	256	33611-04.....	259	33634-08.....	260	33654-06.....	262	33673-06.....	265
33490-20.....	256	33611-06.....	259	33634-10.....	260	33654-08.....	262	33673-09.....	265
33490-30.....	256	33611-08.....	259	33634-12.....	260	33654-10.....	262	33673-13.....	265
33490-40.....	256	33611-10.....	259	33634-15.....	260	33654-12.....	262	33673-16.....	265
33490-50.....	256	33611-12.....	259	33634-20.....	260	33654-15.....	262	33673-19.....	265
33491-01.....	256	33611-14.....	259	33634-25.....	260	33656-28.....	262	33673-25.....	265
33491-02.....	256	33620-02.....	259	33634-30.....	260	33657-28.....	262	33673-32.....	265
33491-03.....	256	33620-03.....	259	33644-06.....	261	33658-28.....	262	33675-06.....	265
33491-04.....	256	33620-04.....	259	33644-09.....	261	33659-28.....	262	33675-09.....	265
33491-05.....	256	33620-05.....	259	33644-13.....	261	33660-07.....	263	33675-13.....	265
33491-06.....	256	33620-06.....	259	33644-16.....	261	33660-10.....	263	33675-16.....	265
33491-07.....	256	33620-07.....	259	33644-19.....	261	33660-15.....	263	33675-19.....	265
33491-08.....	256	33620-08.....	259	33644-25.....	261	33660-20.....	263	33675-25.....	265
33492-13.....	257	33622-02.....	259	33644-32.....	261	33660-25.....	263	33675-32.....	265
33492-16.....	257	33622-03.....	259	33645-06.....	261	33660-30.....	263	33676-01.....	266

33676-02.....266	33716-18.....276	33804-15.....285	34101-04.....295	34320-25.....302
33676-05.....266	33717-19-01.....277	33805-22.....285	34101-05.....295	34320-27.....302
33676-10.....266	33717-19-02.....277	33805-33.....285	34101-06.....295	34320-30.....302
33676-16.....266	33718-16.....277	33807-24.....285	34101-07.....295	34320-32.....302
33676-25.....266	33719-17.....277	33809-22.....285	34105-01.....296	34320-35.....302
33677-05.....266	33720-19.....277	33810-24.....286	34110-00.....296	34320-40.....302
33677-10.....266	33720-21.....277	33811-06.....286	34112-00.....296	34320-45.....302
33677-16.....266	33721-17.....278	33811-08.....286	34112-01.....296	34320-50.....302
33677-25.....266	33723-17.....278	33812-16.....286/1	34112-02.....296	34320-60.....302
33678-24.....267	33725-17.....278	33813-12.....286/1	34114-39.....296	34320-70.....302
33679-13.....267	33727-17.....278	33814-44.....286/2	34116-30.....296	34321-10.....302
33680-22.....267	33728-24.....278	33814-65.....286/2	34118-31.....296	34321-15.....302
33682-01.....268	33729-01.....278	33823-26.....288	34120-23.....296	34321-20.....302
33682-02.....268	33729-02.....278	33825-26.....288	34161-13.....297	34321-25.....302
33682-22.....267	33729-03.....278	33826-00.....289	34162-13.....297	34321-27.....302
33683-01.....268	33729-04.....278	33826-01.....289	34172-00.....297	34321-30.....302
33683-02.....268	33729-05.....278	33826-02.....289	34172-01.....297	34321-32.....302
33683-03.....268	33729-06.....278	33826-03.....289	34175-00.....297	34321-35.....302
33683-04.....268	33729-07.....278	33827-17.....289	34175-01.....297	34321-40.....302
33683-05.....268	33729-24.....278	33828-21.....290	34210-20.....298	34321-45.....302
33683-06.....268	33731-22.....279	33829-25.....290	34212-25.....298	34321-50.....302
33684-00.....269	33733-22.....279	33830-23.....290	34212-30.....298	34321-60.....302
33686-25.....270	33740-19.....279	33831-16.....291	34212-35.....298	34321-65.....302
33687-75.....270	33741-18.....279	33832-01.....291	34212-40.....298	34321-70.....302
33688-45.....270	33742-18.....279	33832-02.....291	34214-05.....298	34321-80.....302
33689-90.....270	33743-18.....279	33832-03.....291	34214-08.....298	34321-90.....302
33690-22.....270	33745-19.....280	33832-04.....291	34214-10.....298	34322-00.....302
33691-34.....271	33746-19.....280	33832-05.....291	34214-12.....298	34322-11.....302
33692-26.....271	33747-18.....280	33833-16.....291	34214-16.....298	34322-15.....302
33693-32.....271	33748-20.....280	33910-17.....292	34216-10.....298	34322-20.....302
33693-33.....271	33749-10.....280	33911-17.....292	34216-15.....298	34322-25.....302
33693-34.....271	33749-13.....280	33913-17.....292	34216-20.....298	34322-27.....302
33694-01.....270	33749-19.....280	33921-22.....292	34220-24.....298	34322-32.....302
33694-03.....270	33749-25.....280	33923-22.....292	34222-25.....298	34322-35.....302
33695-40.....271	33754-17.....282	33950-01.....292	34222-30.....298	34322-45.....302
33696-75.....271	33755-17.....282	33950-02.....292	34222-35.....298	34392-14.....304
33698-98.....271	33756-17.....282	33950-03.....292	34230-28.....298	34393-18.....304
33699-00.....270	33757-17.....282	33950-04.....292	34231-15.....298	34393-21.....304
33699-17.....271	33758-01.....281	33950-05.....292	34232-00.....298	34394-14.....304
33700-01.....272	33758-02.....281	33960-15.....292	34240-27.....299	34401-08.....306
33700-01-01.....272	33758-04.....280	33960-25.....292	34241-00.....299	34401-10.....306
33700-02.....272	33758-06.....280	33960-45.....292	34242-09.....299	34401-11.....306
33700-03.....272	33758-08.....280	33960-55.....292	34242-14.....299	34401-12.....306
33700-04.....272	33759-06.....282	33961-15.....292	34242-16.....299	34401-13.....306
33700-05.....273	33759-12.....282	33962-16.....292	34242-22.....299	34401-14.....306
33700-06.....273	33759-19.....282	33963-12.....293	34243-02.....299	34401-15.....306
33700-07.....273	33759-25.....282	33964-15.....293	34244-10.....299	34401-16.....306
33700-08.....273	33760-01.....282	33964-19.....293	34244-14.....299	34401-17.....306
33702-15.....274	33760-02.....282	33964-24.....293	34244-16.....299	34401-18.....306
33703-15.....274	33760-03.....282	33965-15.....293	34244-17.....299	34401-20.....306
33704-01.....274	33761-21.....282	33965-19.....293	34246-00.....299	34401-22.....306
33704-02.....274	33763-01.....282	33965-24.....293	34248-00.....299	34401-23.....306
33705-05.....274	33763-02.....282	33966-11.....293	34250-00.....299	34401-24.....306
33705-10.....274	33763-03.....282	33966-15.....293	34252-00.....299	34401-25.....306
33705-15.....274	33763-04.....282	33967-15.....293	34270-00.....299	34401-28.....306
33705-20.....274	33765-17.....283	33967-20.....294	34270-01.....299	34401-30.....306
33705-25.....274	33767-19.....283	33968-30.....294	34280-00.....300	34402-08.....306
33706-18.....274	33769-30.....283	33968-60.....294	34290-00.....300	34402-10.....306
33707-17.....275	33771-71.....283	33969-18.....294	34295-00.....300	34402-11.....306
33708-19.....275	33771-73.....283	33969-23.....294	34296-00.....300	34402-12.....306
33709-21.....275	33801-08.....284	33970-01.....294	34296-05.....300	34402-13.....306
33710-19.....275	33801-12.....284	33970-02.....294	34296-10.....300	34402-14.....306
33711-16.....276	33801-18.....284	33970-03.....294	34296-15.....300	34402-15.....306
33711-18.....275	33801-43.....284	33971-24.....294	34296-20.....300	34402-16.....306
33711-20.....275	33801-70.....284	33972-22.....294	34296-25.....301	34402-17.....306
33711-21.....275	33802-01.....284	33973-27.....294	34296-30.....301	34402-18.....306
33712-16.....276	33802-02.....284	33975-30.....294	34296-35.....301	34402-19.....306
33713-16.....276	33802-14.....284	33977-28.....294	34296-40.....301	34402-20.....306
33713-17.....276	33803-05.....284	34101-01.....295	34320-10.....302	34402-22.....306
33714-15.....276	33803-07.....284	34101-02.....295	34320-15.....302	34402-23.....306
33715-20.....276	33803-43.....285	34101-03.....295	34320-20.....302	34402-24.....306

34435-10.....308	34445-18.....309	34519-02.....313	34570-02.....321	41056-28.....328
34435-12.....308	34445-20.....309	34520-02.....314	34573-35.....321	41058-18.....328
34435-14.....308	34445-25.....309	34520-03.....314	34583-60.....321	41058-28.....328
34435-16.....308	34445-28.....309	34520-04.....314	34584-60.....321	41061-16.....329
34435-18.....308	34445-30.....309	34520-05.....314	34585-60.....321	41064-16.....329
34435-20.....308	34446-16.....309	34520-06.....314	34588-01.....321	41068-20.....329
34435-22.....308	34446-18.....309	34520-07.....314	34588-02.....321	41069-20.....329
34435-23.....308	34446-20.....309	34520-08.....314	34588-03.....321	41070-29.....329
34435-24.....308	34446-25.....309	34520-09.....314	34590-00.....322	41074-23.....329/1
34435-26.....308	34446-28.....309	34520-10.....314	34590-01.....322	41075-24.....329/1
34435-28.....308	34446-30.....309	34520-12.....314	34590-02.....322	41076-03.....329/1
34435-30.....308	34447-16.....309	34520-15.....314	34596-29.....322	41076-04.....329/1
34436-16.....308	34447-18.....309	34528-01.....315	34596-37.....322	41076-05.....329/1
34436-18.....308	34447-20.....309	34528-02.....315	34596-42.....322	41076-07.....329/1
34436-20.....308	34447-25.....309	34528-03.....315	34596-49.....322	41078-23.....329/2
34436-25.....308	34447-28.....309	34530-28.....315	34597-06.....322	41079-21.....329/2
34436-28.....308	34447-30.....309	34531-21.....315	34597-07.....322	41080-19.....330
34436-30.....308	34450-08.....310	34533-17.....316	34597-08.....322	41081-19.....330
34437-16.....308	34450-10.....310	34534-15.....316	34597-09.....322	41083-19.....330
34437-18.....308	34450-12.....310	34534-18.....316	34597-10.....322	41085-20.....330
34437-20.....308	34450-14.....310	34535-16.....316	34597-11.....322	41090-33.....330
34437-25.....308	34450-15.....310	34536-14.....316	34597-12.....322	41091-31.....330
34437-28.....308	34450-16.....310	34537-19.....316	34597-13.....322	41091-41.....330
34437-30.....308	34450-18.....310	34538-01.....316	34597-14.....322	41092-30.....332
34438-16.....308	34450-20.....310	34538-02.....316	34597-15.....322	41092-40.....332
34438-18.....308	34450-22.....310	34538-03.....316	34597-16.....322	41092-50.....332
34438-20.....308	34450-25.....310	34539-01.....316	34597-17.....322	41092-60.....332
34438-25.....308	34450-30.....310	34539-02.....316	34597-18.....322	41092-70.....332
34438-28.....308	34460-08.....310	34539-03.....316	34597-19.....322	41094-00.....332
34438-30.....308	34460-10.....310	34540-01.....317	34597-20.....322	41096-21.....332
34439-00.....305	34460-12.....310	34540-02.....317	34612-00.....322/1	41097-22.....331
34439-16.....308	34460-14.....310	34540-16.....317	34613-00.....322/1	41141-25.....332
34439-18.....308	34460-15.....310	34540-18.....317	34615-00.....322/1	41143-21.....332
34439-20.....308	34460-16.....310	34540-19.....317	34617-00.....322/1	41145-21.....332
34439-25.....308	34460-20.....310	34540-20.....317	34620-25.....323	41146-18.....332
34439-28.....308	34460-22.....310	34541-23.....317/1	34624-01.....323	41146-24.....332
34439-30.....308	34460-25.....310	34542-15.....317/1	34624-02.....323	41147-21.....332
34440-01.....305	34460-30.....310	34543-23.....317/1	34624-03.....323	41149-22.....332
34440-02.....305	34470-08.....310	34544-18.....317/1	34624-04.....323	41151-24.....332
34440-03.....305	34470-10.....310	34545-22.....318	34628-01.....323	41155-20.....333
34440-16.....308	34470-12.....310	34546-16.....318	34628-02.....323	41156-18.....333
34440-18.....308	34470-14.....310	34546-18.....318	34628-15.....323	41158-01.....333
34440-20.....308	34470-15.....310	34547-01.....320/1	34628-25.....323	41158-02.....333
34440-25.....308	34470-16.....310	34547-02.....320/2	34628-35.....323	41158-03.....333
34440-28.....308	34470-20.....310	34547-03.....320/1	34629-01.....323	41161-01.....333
34440-30.....308	34470-22.....310	34547-23.....320/1	34632-25.....324	41161-02.....333
34441-16.....308	34470-25.....310	34547-28.....320/2	34634-35.....324	41161-03.....333
34441-18.....308	34470-30.....310	34548-18.....318	34637-23.....325	41161-04.....333
34441-20.....308	34480-01.....311	34549-14.....318	34639-22.....325	41161-05.....333
34441-25.....308	34480-02.....311	34550-13.....318	34640-18.....325	41210-23.....334
34441-28.....308	34480-03.....311	34550-18.....318	35548-18.....320/3	41211-23.....334
34441-30.....308	34492-01.....311	34551-17.....318	41011-15.....326	41213-23.....334
34442-16.....309	34492-02.....311	34552-16.....319	41011-19.....326	41221-00.....334
34442-18.....309	34492-03.....311	34554-15.....319	41015-23.....326	41222-00.....334
34442-20.....309	34502-15.....312	34554-18.....319	41015-26.....326	41223-00.....334
34442-25.....309	34502-21.....312	34554-20.....319	41017-23.....326	41224-00.....334
34442-28.....309	34514-18.....312	34555-15.....319	41017-26.....326	41230-19.....335
34442-30.....309	34514-27.....312	34555-18.....319	41019-14.....326	41231-19.....335
34443-16.....309	34515-01.....313	34555-20.....319	41020-00.....326	41232-19.....335
34443-18.....309	34515-02.....313	34556-18.....319	41021-00.....326	41233-19.....335
34443-20.....309	34515-09.....312	34557-22.....320	41025-01.....327	41234-19.....335
34443-25.....309	34515-10.....312	34557-25.....320	41025-02.....327	41236-19.....335
34443-28.....309	34515-11.....312	34557-30.....320	41026-35.....327	41237-19.....335
34443-30.....309	34515-12.....312	34558-32.....320	41026-50.....327	41238-19.....335
34444-16.....309	34515-13.....312	34559-47.....320	41027-00.....327	41239-19.....335
34444-18.....309	34515-15.....312	34560-57.....320	41028-00.....327	41242-19.....336
34444-20.....309	34515-20.....312	34562-24.....321	41051-20.....328	41243-19.....336
34444-25.....309	34518-01.....312	34562-32.....321	41052-20.....328	41244-19.....336
34444-28.....309	34518-02.....312	34562-48.....321	41053-20.....328	41245-19.....336
34444-30.....309	34518-03.....312	34562-64.....321	41054-20.....328	41250-11.....336
34445-16.....309	34519-01.....313	34570-01.....321	41056-18.....328	41250-15.....336

41250-18.....336	41307-04.....338	41512-04.....344	41604-62.....349	41614-58T.....352
41253-07.....336	41307-05.....338	41512-05.....344	41604-62T.....349	41614-65.....352
41253-11.....336	41307-06.....338	41513-01.....344	41604-79.....349	41614-65T.....352
41253-15.....336	41401-16.....339	41513-02.....344	41604-79T.....349	41614-72.....352
41253-18.....336	41405-17.....339	41513-03.....344	41604-87.....349	41614-72T.....352
41254-06.....337	41405-27.....339	41513-04.....344	41604-87T.....349	41615-49.....352
41254-10.....337	41406-01.....339	41513-05.....344	41605-10.....350	41615-49T.....352
41254-13.....337	41406-02.....339	41514-01.....344	41605-10T.....350	41615-50.....352
41254-16.....337	41420-01.....340	41514-02.....344	41605-12.....350	41615-50T.....352
41254-19.....337	41420-02.....340	41514-03.....344	41605-12T.....350	41615-51.....352
41254-25.....337	41420-03.....340	41514-04.....344	41605-13.....350	41615-51T.....352
41254-32.....337	41421-01.....340	41514-05.....344	41605-13T.....350	41616-79.....353
41254-38.....337	41421-02.....340	41515-01.....344	41606-62.....350	41616-79T.....353
41290-21.....337	41421-03.....340	41515-02.....344	41606-62T.....350	41616-91.....353
41294-40.....337	41422-01.....340	41515-03.....344	41606-65.....350	41616-91T.....353
41295-06.....337	41422-02.....340	41515-04.....344	41606-65T.....350	41617-10.....353
41295-07.....337	41422-03.....340	41515-05.....344	41606-78.....350	41617-10T.....353
41295-08.....337	41430-01.....340	41520-03.....344/1	41606-78T.....350	41617-65.....353
41295-09.....337	41430-02.....340	41520-05.....344/1	41606-84.....350	41617-65T.....353
41295-10.....337	41430-03.....340	41522-03.....344/1	41606-84T.....350	41617-72.....353
41295-11.....337	41431-01.....340	41522-05.....344/1	41607-56.....350	41617-72T.....353
41295-12.....337	41431-02.....340	41524-03.....344/1	41607-56T.....350	41617-78.....353
41295-15.....337	41431-03.....340	41524-05.....344/1	41607-57.....350	41617-78T.....353
41297-06.....337	41432-01.....340	41526-03.....344/1	41607-57T.....350	41618-55.....353
41297-07.....337	41432-02.....340	41526-05.....344/1	41607-58.....350	41618-55T.....353
41297-08.....337	41432-03.....340	41527-03.....344/1	41607-58T.....350	41618-56.....353
41297-09.....337	41440-01.....340	41527-05.....344/1	41607-59.....350	41618-56T.....353
41297-10.....337	41440-02.....340	41529-03.....344/1	41607-59T.....350	41618-57.....353
41297-11.....337	41440-03.....340	41529-05.....344/1	41607-60.....350	41618-57T.....353
41297-12.....337	41441-01.....340	41540-02.....344/2	41607-60T.....350	41618-79.....353
41298-12.....337	41441-02.....340	41540-03.....344/2	41607-72.....350	41618-79T.....353
41299-03.....336	41441-03.....340	41540-04.....344/2	41607-72T.....350	41618-88.....353
41299-05.....336	41442-01.....340	41540-05.....344/2	41607-73.....350	41618-88T.....353
41299-07.....336	41442-02.....340	41542-02.....344/2	41607-73T.....350	41619-00.....353
41300-02.....337/1	41442-03.....340	41542-03.....344/2	41607-82.....350	41619-00T.....353
41300-03.....337/1	41443-26.....341	41542-04.....344/2	41607-82T.....350	41620-58.....354
41300-04.....337/1	41444-01.....341	41542-05.....344/2	41608-57.....350	41620-58T.....354
41300-05.....337/1	41444-02.....341	41600-62.....349	41608-57T.....350	41620-59.....354
41301-15.....337/1	41444-03.....341	41600-62T.....349	41608-80.....350	41620-59T.....354
41301-20.....337/1	41445-25.....341/1	41600-70.....349	41608-80T.....350	41620-60.....354
41301-25.....337/1	41446-00.....341/1	41600-70T.....349	41609-70.....350	41620-60T.....354
41301-35.....337/1	41447-27.....341/2	41600-78.....349	41609-70T.....350	41620-61.....354
41302-02.....337/1	41448-02.....342	41600-78T.....349	41610-61.....351	41620-61T.....354
41303-09.....337/2	41448-03.....342	41600-92.....349	41610-61T.....351	41620-62.....354
41303-12.....337/2	41448-04.....342	41600-92T.....349	41610-68.....351	41620-62T.....354
41303-15.....337/2	41449-01.....342	41601-10.....349	41610-68T.....351	41620-63.....354
41303-18.....337/2	41449-02.....342	41601-10T.....349	41610-70.....351	41620-63T.....354
41303-25.....337/2	41449-03.....342	41601-11.....349	41610-70T.....351	41620-70.....354
41303-30.....337/2	41451-01.....343	41601-11T.....349	41611-74.....351	41620-70T.....354
41303-45.....337/2	41451-02.....343	41601-13.....349	41611-74T.....351	41620-78.....354
41304-06.....338	41451-03.....343	41601-13T.....349	41611-87.....351	41620-78T.....354
41304-08.....338	41452-01.....343	41602-60.....349	41611-87T.....351	41620-88.....354
41304-10.....338	41452-02.....343	41602-60T.....349	41611-92.....351	41620-88T.....354
41305-05.....338	41452-03.....343	41602-68.....349	41611-92T.....351	41621-58.....354
41305-06.....338	41453-01.....343	41602-68T.....349	41612-07.....351	41621-58T.....354
41305-07.....338	41453-02.....343	41602-75.....349	41612-07T.....351	41621-62.....354
41305-08.....338	41453-03.....343	41602-75T.....349	41612-09.....351	41621-62T.....354
41305-09.....338	41458-20.....343	41602-87.....349	41612-09T.....351	41622-58.....354
41305-10.....338	41510-01.....344	41602-87T.....349	41612-11.....351	41622-58T.....354
41305-12.....338	41510-02.....344	41603-55.....349	41612-11T.....351	41622-62.....354
41305-15.....338	41510-03.....344	41603-55T.....349	41612-12.....351	41622-62T.....354
41305-18.....338	41510-04.....344	41603-61.....349	41612-12T.....351	41623-56.....354
41305-20.....338	41510-05.....344	41603-61T.....349	41612-62.....351	41623-56T.....354
41305-25.....338	41511-01.....344	41603-65.....349	41612-62T.....351	41624-56.....354
41305-30.....338	41511-02.....344	41603-65T.....349	41613-74.....352	41624-56T.....354
41306-05.....337/1	41511-03.....344	41603-74.....349	41613-74T.....352	41625-56.....354
41306-07.....337/1	41511-04.....344	41603-74T.....349	41613-84.....352	41625-56T.....354
41306-09.....337/1	41511-05.....344	41604-54.....349	41613-84T.....352	41626-56.....354
41306-12.....337/1	41512-01.....344	41604-54T.....349	41613-96.....352	41626-56T.....354
41307-00.....338	41512-02.....344	41604-58.....349	41613-96T.....352	41627-33.....355
41307-03.....338	41512-03.....344	41604-58T.....349	41614-58.....352	41627-33T.....355

41627-40.....355	41648-07.....358	41830-30.....368/1	43251-12.....373	43441-02.....378
41627-40T.....355	41648-09.....358	41832-32.....368/1	43253-12.....373	43443-13.....378
41628-33.....355	41648-11.....358	41842-42.....368/4	43256-12.....373	43445-13.....378
41628-33T.....355	41649-07.....359	41842-44.....368/4	43258-12.....373	43447-13.....378
41628-40.....355	41649-09.....359	41842-46.....368/4	43262-12.....373	43449-01.....378
41628-40T.....355	41649-11.....359	41843-50.....368/4	43271-11.....373	43449-02.....378
41628-46.....355	41650-07.....359	41850-41.....368/4	43273-13.....373	43461-13.....378
41628-46T.....355	41650-09.....359	41860-14.....369	43304-12.....374	43462-13.....378
41629-32.....355	41650-11.....359	41860-17.....369	43305-12.....374	43482-20.....378
41629-32T.....355	41651-07.....359	41860-20.....369	43308-12.....374	43485-13.....378
41629-38.....355	41651-09.....359	41870-08.....369	43309-12.....374	43487-14.....378
41629-38T.....355	41651-11.....359	41870-11.....369	43310-13.....374	43501-06.....379
41630-36.....355	41652-07.....359	41870-14.....369	43311-13.....374	43501-10.....379
41630-36T.....355	41652-09.....359	41870-17.....369	43314-13.....374	43501-12.....379
41630-38.....355	41652-11.....359	41880-01.....369	43321-12.....374	43511-13.....379
41630-38T.....355	41653-18.....360	41880-02.....369	43325-13.....374	43513-13.....379
41631-36.....355	41654-18.....360	41880-03.....369	43327-12.....374	43515-14.....379
41631-36T.....355	41655-18.....360	43101-03.....370	43330-13.....374	43517-09.....379
41631-40.....355	41656-18.....360	43101-04.....370	43331-11.....374	43521-12.....379
41631-40T.....355	41657-17.....360	43104-07.....370	43332-12.....374	43523-12.....379
41631-44.....355	41657-21.....360	43105-06.....370	43334-12.....374	43524-10.....379
41631-44T.....355	41657-23.....360	43106-05.....370	43336-12.....374	43525-05.....379
41632-36.....355	41658-17.....360	43107-08.....370	43340-13.....374	43525-07.....379
41632-36T.....355	41658-21.....360	43109-07.....370	43342-12.....374	43525-10.....379
41633-35.....355	41658-23.....360	43109-09.....370	43351-01.....375	43526-12.....379
41633-35T.....355	41659-17.....360	43110-08.....370	43351-02.....375	43542-12.....380
41633-40.....355	41659-21.....360	43111-07.....370	43351-03.....375	43544-12.....380
41633-40T.....355	41659-23.....360	43113-07.....370	43353-13.....375	43546-13.....380
41634-35.....355	41660-17.....360	43115-05.....370	43355-13.....375	43548-13.....380
41634-35T.....355	41660-21.....360	43121-07.....370	43357-13.....375	43583-07.....380
41634-60.....355	41660-23.....360	43123-07.....370	43363-01.....375	43589-13.....380
41634-60T.....355	41661-40.....361	43125-05.....370	43363-02.....375	43593-09.....380
41634-70.....355	41661-50.....361	43125-07.....370	43370-12.....375	43602-01.....381
41634-70T.....355	41662-50.....361	43127-08.....370	43372-13.....375	43602-02.....381
41635-57.....355	41663-01.....361	43128-08.....370	43373-13.....375	43602-03.....381
41635-57T.....355	41663-02.....361	43129-07.....371	43376-13.....375	43605-12.....381
41636-45.....355	41664-10.....362	43130-07.....371	43377-13.....375	43605-34.....381
41636-45T.....355	41664-14.....362	43132-08.....371	43380-13.....375	43605-56.....381
41637-33.....356	41665-10.....362	43133-08.....371	43381-13.....375	43608-12.....381
41637-33T.....356	41665-14.....362	43135-07.....371	43383-13.....375	43609-14.....381
41637-40.....356	41666-00.....362	43139-07.....371	43386-13.....375	43610-01.....381
41637-40T.....356	41667-30.....363	43140-08.....371	43387-02.....376	43610-02.....381
41638-38.....356	41667-50.....363	43141-08.....371	43388-02.....376	43613-00.....381
41638-38T.....356	41668-50.....363	43150-11.....371	43389-02.....376	43614-00.....381
41638-46.....356	41669-50.....363	43170-00.....371	43390-05.....376	43614-01.....381
41638-46T.....356	41670-50.....363	43170-01.....371	43391-13.....376	43614-12.....381
41639-44.....356	41672-01.....364	43170-02.....371	43402-05.....377	43614-23.....381
41639-44T.....356	41672-02.....364	43170-03.....371	43402-10.....377	43614-34.....381
41640-40.....356	41672-03.....364	43172-13.....371	43402-15.....377	43614-45.....381
41640-40T.....356	41672-04.....364	43180-01.....372	43402-18.....377	43614-56.....381
41641-07.....357	41674-50.....365	43180-02.....372	43402-20.....377	43614-67.....381
41641-09.....357	41674-80.....365	43180-03.....372	43402-25.....377	43614-78.....381
41641-11.....357	41675-50.....365	43181-01.....372	43402-35.....377	43802-07.....382
41642-07.....357	41675-80.....365	43181-02.....372	43402-40.....377	43803-07.....382
41642-09.....357	41676-50.....365	43181-03.....372	43402-45.....377	43804-07.....382
41642-11.....357	41676-80.....365	43183-13.....372	43404-10.....377	43805-07.....382
41643-07.....357	41677-50.....365	43185-13.....372	43404-20.....377	43810-10.....382
41643-09.....357	41677-80.....365	43187-13.....372	43404-24.....377	43811-10.....382
41643-11.....357	41678-50.....365	43202-01.....372	43404-30.....377	43813-10.....382
41644-07.....357	41678-80.....365	43202-02.....372	43404-35.....377	43820-10.....382
41644-09.....357	41679-25.....366	43202-03.....372	43407-13.....377	43821-10.....382
41644-11.....357	41680-00.....366	43210-01.....372	43410-01.....377	43823-10.....382
41645-07.....358	41801-01.....368	43210-02.....372	43410-02.....377	43830-10.....383
41645-09.....358	41802-00.....368/3	43210-03.....372	43412-01.....377	43831-10.....383
41645-11.....358	41802-02.....368	43213-12.....372	43412-02.....377	43833-10.....383
41646-07.....358	41803-01.....368/2	43218-12.....373	43414-02.....378	43840-10.....383
41646-09.....358	41807-00.....368/2	43221-11.....373	43420-01.....378	43841-10.....383
41646-11.....358	41810-10.....368/2	43228-12.....373	43420-02.....378	43843-10.....383
41647-07.....358	41821-21.....368/1	43231-12.....373	43420-03.....378	43850-08.....383
41647-09.....358	41822-22.....368/1	43233-13.....373	43424-13.....378	43851-08.....383
41647-11.....358	41826-26.....368/1	43245-12.....373	43441-01.....378	43852-08.....383

43853-08.....383	44166-07.....392	45015-65.....399	45098-20.....407	45194-04.....410
43855-07.....384	44181-10.....392	45018-00.....399	45098-50.....407	45201-11.....410
43857-07.....384	44190-08.....392	45018-50.....399	45099-01.....407	45201-13.....410
43861-07.....384	44202-08.....392	45018-60.....399	45099-02.....407	45203-11.....410
43863-07.....384	44210-10.....392	45018-70.....399	45099-05.....407	45206-14.....410
43865-07.....384	44220-10.....392	45018-80.....399	45099-10.....407	45206-16.....410
43869-07.....384	44240-09.....393	45020-01.....400	45099-20.....407	45207-16.....410
43881-07.....384	44242-09.....393	45020-02.....400	45099-50.....407	45208-14.....410
43883-07.....384	44246-09.....393	45020-03.....400	45109-00.....407	45220-16.....411
43885-07.....384	44254-09.....393	45020-04.....400	45110-00.....407	45222-17.....411
43887-07.....384	44256-09.....393	45030-04.....401	45110-01.....407	45225-02.....411
43891-09.....385	44258-09.....393	45030-06.....401	45110-02.....407	45243-14.....411
43902-09.....385	44265-10.....393	45030-07.....401	45110-03.....407	45245-12.....411
43903-09.....385	44267-10.....393	45030-08.....401	45110-04.....407	45246-12.....411
43907-10.....385	44274-11.....393	45030-10.....401	45110-05.....407	45246-14.....411
43909-10.....385	44300-00.....394	45036-03.....402	45111-00.....407	45251-10.....412
43914-10.....385	44301-00.....394	45036-06.....402	45112-00.....407	45253-11.....412
43916-10.....385	44310-00.....394	45036-07.....402	45112-01.....407	45255-08.....412
43920-11.....385	44311-00.....394	45036-08.....402	45112-02.....407	45257-08.....412
43924-11.....386	44320-00.....394	45036-09.....401	45112-03.....407	45261-08.....412
43926-11.....386	44330-00.....394	45036-10.....401	45112-04.....407	45261-14.....412
43940-05.....386	44340-00.....394	45060-01.....403	45112-05.....407	45261-16.....412
43940-08.....386	44350-00.....394	45060-02.....403	45114-00.....407	45263-08.....412
43942-05.....386	44370-00.....394/1	45060-03.....403	45115-00.....407	45263-14.....412
43942-08.....386	44371-00.....394/1	45060-04.....403	45115-01.....407	45265-08.....412
43944-07.....387	44372-00.....394/1	45060-05.....403	45115-02.....407	45267-20.....412
43946-07.....387	44373-00.....394/1	45061-00.....403	45115-03.....407	45267-25.....412
43948-10.....387	44374-00.....394/1	45070-01.....403	45115-04.....407	45267-30.....412
43950-10.....387	44380-00.....394/2	45070-02.....403	45115-05.....407	45269-30.....412
43952-10.....387	44390-00.....394/2	45070-03.....403	45116-00.....407	45271-08.....412
43953-10.....387	44404-00.....394/2	45070-04.....403	45117-00.....407	45273-08.....412
43955-10.....387	44404-00G.....394/2	45070-05.....403	45117-01.....407	45275-08.....412
43956-10.....387	44406-00.....394/2	45070-06.....403	45117-02.....407	45310-40.....413
44015-20.....389	44406-00G.....394/2	45071-00.....403	45117-03.....407	45312-55.....413
44017-08.....389	44408-00.....395	45072-01.....404	45117-04.....407	45313-55.....413
44046-11.....389	44420-09.....395	45073-01.....404	45117-05.....407	45315-55.....413
44050-11.....389	44422-09.....395	45073-02.....404	45133-01.....408	45317-55.....413
44052-11.....389	44424-08.....395	45073-03.....404	45133-02.....408	45320-70.....413
44054-09.....389	44425-10.....395	45073-04.....404	45133-03.....408	45321-70.....413
44066-09.....390	44426-09.....395	45073-05.....404	45133-04.....408	45322-70.....413
44067-09.....390	44428-09.....395	45073-06.....404	45133-05.....408	45350-40.....413
44068-09.....390	45009-00.....399	45074-01.....404	45150-18.....408	45350-70.....413
44069-09.....390	45009-02.....399	45075-00.....404	45151-16.....408	45352-40.....413
44074-10.....390	45009-03.....399	45076-01.....404	45152-01.....408	45353-60.....413
44076-05.....390	45009-04.....399	45080-00.....405	45152-02.....408	45355-60.....413
44076-10.....390	45010-00.....399	45090-00.....405	45153-16.....408	45357-40.....413
44078-05.....390	45010-20.....399	45090-02.....405	45160-15.....408	45359-40.....413
44078-10.....390	45010-30.....399	45090-03.....405	45162-18.....408	45360-35.....413
44101-07.....390	45010-45.....399	45090-04.....405	45164-17.....408	45362-45.....414
44103-09.....391	45010-55.....399	45090-05.....405	45165-17.....408	45363-45.....414
44106-10.....391	45010-65.....399	45090-06.....405	45171-12.....409	45365-45.....414
44109-10.....391	45010-75.....399	45090-08.....405	45180-01.....409	45367-50.....414
44111-10.....391	45011-00.....399	45091-00.....406	45180-02.....409	45369-50.....414
44114-10.....391	45011-03.....399	45091-01.....406	45180-03.....409	45370-50.....414
44115-10.....391	45011-04.....399	45091-02.....406	45181-13.....409	45371-40.....414
44117-10.....391	45011-05.....399	45091-03.....406	45184-16.....409	45373-30.....414
44119-10.....391	45011-07.....399	45091-04.....406	45185-15.....409	45375-60.....414
44121-10.....391	45011-08.....399	45091-15.....406	45190-01.....409	45377-60.....414
44125-06.....391	45012-00.....399	45091-17.....406	45190-02.....409	45381-30.....414
44127-06.....391	45012-40.....399	45091-22.....406	45192-01.....409	45383-30.....414
44129-07.....391	45012-55.....399	45096-50.....406	45192-02.....409	45385-01.....414
44150-01.....392	45012-65.....399	45096-75.....406	45192-03.....409	45385-02.....414
44150-03.....392	45012-75.....399	45097-01.....406	45192-04.....409	45387-01.....414
44150-05.....392	45014-00.....399	45097-02.....406	45192-05.....409	45387-02.....414
44150-10.....392	45014-45.....399	45097-03.....406	45192-06.....409	45390-35.....415
44150-15.....392	45014-55.....399	45097-10.....406	45193-01.....409	45390-50.....415
44151-05.....392	45014-65.....399	45097-15.....406	45193-02.....409	45391-35.....415
44151-10.....392	45014-75.....399	45098-01.....407	45193-03.....409	45392-35.....415
44151-15.....392	45015-00.....399	45098-02.....407	45194-01.....410	45393-50.....415
44164-10.....392	45015-45.....399	45098-05.....407	45194-02.....410	45394-50.....415
	45015-55.....399	45098-10.....407	45194-03.....410	45400-01.....416

45400-02.....416	45751-16.....420	47197-01.....426	47350-26.....433/2	47470-07.....441
45400-03.....416	45753-16.....420	47197-02.....426	47351-26.....433/2	47471-02.....441
45401-25.....416	45755-16.....420	47223-01.....426	47352-24.....433/2	47471-03.....441
45402-10.....416	45757-16.....420	47223-02.....426	47355-03.....433/2	47471-04.....441
45403-13.....416	45760-01.....420	47223-03.....426	47370-16.....434	47471-05.....441
45404-13.....416	45760-02.....420	47223-04.....426	47371-16.....434	47471-06.....441
45410-01.....417	45762-01.....420	47223-05.....426	47372-16.....434	47471-07.....441
45411-01.....417	45762-02.....420	47224-01.....426	47373-16.....434	47471-08.....441
45412-01.....417	45766-35.....420	47224-02.....426	47374-16.....434	47471-10.....441
45413-01.....417	45766-40.....420	47224-03.....426	47375-16.....434	47471-12.....441
45414-01.....417	45766-45.....420	47224-04.....426	47375-19.....434	47472-10.....441
45701-01.....418	45766-50.....420	47224-05.....426	47376-16.....435	47472-12.....441
45701-02.....418	45802-16.....420	47235-05.....427	47379-16.....435	47472-14.....441
45703-15.....418	45803-16.....420	47235-07.....427	47380-15.....435	47472-16.....441
45704-15.....418	45805-16.....420	47235-09.....427	47382-15.....435	47473-01.....442
45705-15.....418	45807-20.....420	47235-11.....427	47384-15.....435	47473-02.....442
45706-35.....418	47050-01.....421	47237-01.....427	47385-15.....435	47473-03.....442
45709-10.....418	47050-02.....421	47237-02.....427	47386-01.....435	47474-01.....442
45709-14.....418	47050-03.....421	47237-03.....427	47386-02.....435	47474-02.....442
45709-16.....418	47050-04.....421	47239-01.....427	47387-01.....435	47474-03.....442
45709-20.....418	47050-05.....421	47239-02.....427	47387-02.....435	47481-05.....442/1
45709-26.....418	47050-06.....421	47240-19.....427	47390-03.....436	47482-05.....442/1
45709-28.....418	47050-07.....421	47242-00.....427	47390-04.....436	47484-04.....442/1
45709-30.....418	47060-01.....421	47242-01.....427	47390-05.....436	47484-06.....442/1
45710-15.....419	47060-02.....421	47251-21.....428	47392-03.....436	47484-08.....442/1
45711-15.....419	47062-03.....421	47255-01.....428	47392-04.....436	47486-16.....442/1
45713-15.....419	47102-01.....421	47255-02.....428	47392-05.....436	47487-16.....442/1
45715-17.....419	47102-02.....421	47256-20.....428	47410-04.....437	47489-16.....442/1
45720-03.....419	47102-03.....421	47303-03.....428	47410-05.....437	47502-16.....443
45720-06.....419	47103-01.....422	47303-04.....428	47410-16.....437	47504-18.....443
45720-10.....419	47103-02.....422	47303-05.....428	47411-16.....437	47507-17.....443
45722-03.....419	47103-03.....422	47303-06.....428	47413-19.....437	47507-19.....443
45722-06.....419	47112-01.....421	47304-01.....429	47414-21.....437	47511-21.....443
45722-10.....419	47112-02.....421	47304-02.....429	47415-18.....437	47513-21.....443
45722-12.....419	47112-03.....421	47304-03.....429	47417-19.....437	47514-16.....443
45722-15.....419	47113-03.....421	47304-04.....429	47419-19.....437	47516-16.....443
45722-20.....419	47116-13.....423	47305-01.....429	47420-01.....438	47518-21.....444
45722-25.....419	47118-13.....423	47305-02.....429	47420-02.....438	47520-21.....444
45724-03.....419	47120-35.....423	47305-03.....429	47420-03.....438	47521-01.....444
45724-06.....419	47120-50.....423	47311-10.....430	47420-04.....438	47521-02.....444
45724-10.....419	47120-75.....423	47311-25.....430	47420-20.....438	47521-03.....444
45724-12.....419	47120-90.....423	47311-30.....430	47421-21.....438	47522-01.....445
45724-15.....419	47124-35.....423	47315-00.....430	47421-23.....439	47522-04.....445
45724-20.....419	47124-50.....423	47316-00.....430	47422-22.....439	47522-05.....445
45724-25.....419	47124-75.....423	47316-16.....431	47423-22.....439	47522-07.....445
45725-05.....419	47124-90.....423	47317-00.....430	47424-16.....439	47522-09.....445
45725-10.....419	47139-12.....423	47317-11.....431	47425-19.....439	47523-01.....446
45730-03.....419	47139-14.....423	47317-65.....431	47426-22.....439	47523-02.....446
45730-06.....419	47139-16.....423	47317-70.....431	47428-21.....439	47526-16.....446
45730-10.....419	47139-18.....423	47317-90.....431	47430-22.....439	47527-16.....446
45732-03.....419	47151-15.....424	47318-11.....431	47450-04.....439	47529-16.....446
45732-06.....419	47151-18.....424	47318-65.....431	47451-04.....439	47532-19.....446
45732-10.....419	47154-20.....424	47318-70.....431	47454-04.....440	47533-19.....446
45733-05.....419	47155-20.....424	47318-90.....431	47454-07.....440	47534-19.....446
45733-10.....419	47158-20.....424	47319-35.....432	47454-09.....440	47535-01.....446
45735-05.....419	47159-20.....424	47319-45.....432	47454-12.....440	47535-02.....446
45735-10.....419	47161-16.....424	47323-19.....430	47455-06.....440	47540-16.....447
45736-15.....419	47161-20.....424	47325-19.....430	47458-04.....440	47541-14.....447
45737-15.....419	47167-18.....425	47331-20.....433	47458-07.....440	47542-12.....447
45741-03.....419	47169-18.....425	47331-25.....433	47458-09.....440	47551-16.....447
45741-06.....419	47171-14.....425	47331-30.....433	47458-12.....440	47551-16L.....447
45741-10.....419	47173-14.....425	47331-40.....433	47460-04.....440	47552-16.....447
45743-03.....419	47181-18.....425	47332-20.....433	47460-07.....440	47553-15.....447/1
45743-06.....419	47185-18.....425	47332-25.....433	47460-12.....440	47554-01.....447/1
45743-10.....419	47191-01.....425	47332-30.....433	47461-00.....440	47554-02.....447/1
45745-03.....419	47191-02.....425	47332-40.....433	47463-10.....440	47554-03.....447/1
45745-06.....419	47191-03.....425	47342-25.....433	47463-12.....440	47555-08.....447/1
45745-10.....419	47191-04.....425	47342-30.....433	47463-14.....440	47556-16.....447/1
45747-03.....419	47192-16.....426	47342-40.....433	47470-04.....441	47557-17.....447/1
45747-06.....419	47195-01.....426	47345-15.....433/1	47470-05.....441	47558-15.....448
45747-10.....419	47195-02.....426	47347-20.....433/1	47470-06.....441	47559-20.....448

47560-18.....	448	49274-13.....	454	49640-07.....	462	51187-19.....	467	53230-03.....	473
47562-18.....	448	49274-15.....	454	49640-09.....	462	51191-19.....	467	53230-04.....	473
47563-22.....	448	49287-02.....	455	49650-06.....	462	51193-19.....	467	53230-05.....	473
47564-16.....	448	49287-03.....	455	49650-07.....	462	51202-19.....	467	53230-06.....	473
47565-10.....	448	49287-04.....	455	49650-09.....	462	51203-19.....	467	53230-07.....	473
47566-12.....	448	49287-05.....	455	49650-11.....	462	51205-18.....	467	53230-08.....	473
47571-23.....	449	49288-02.....	455	49660-18.....	463	51205-23.....	467	53240-01.....	473
47572-23.....	449	49288-03.....	455	49665-24.....	463	51207-21.....	467	53240-02.....	473
47573-23.....	449	49288-04.....	455	49670-19.....	463	51209-20.....	467	53240-03.....	473
47575-23.....	449	49288-05.....	455	49670-20.....	463	51210-20.....	468	53240-04.....	473
47601-21.....	449	49310-00.....	455	49670-23.....	463	51211-21.....	468	53240-05.....	473
47607-01.....	449	49310-01.....	455	49671-01.....	463/1	51213-21.....	468	53240-06.....	473
47607-02.....	449	49310-02.....	455	49671-01CL.....	463/1	51219-22.....	468	53240-07.....	473
47607-03.....	449	49310-03.....	455	49671-02.....	463/1	51250-28.....	468	53240-08.....	473
47607-04.....	449	49310-04.....	455	49671-02CL.....	463/1	51252-28.....	468	53250-01.....	473
47607-05.....	449	49310-05.....	455	49673-01.....	463/2	51256-28.....	468	53250-02.....	473
47607-06.....	449	49310-10.....	455	49673-02.....	463/2	51257-40.....	468	53250-03.....	473
47620-00.....	450	49310-12.....	455	49673-03.....	463/2	51257-50.....	468	53250-04.....	473
47620-01.....	450	49315-00.....	456	49673-04.....	463/2	51259-03.....	468	53250-05.....	473
47620-02.....	450	49315-01.....	456	49675-18.....	463/3	51259-04.....	468	53250-06.....	473
47620-03.....	450	49315-02.....	456	49680-10.....	463/3	51259-05.....	468	53250-07.....	473
47620-04.....	450	49315-03.....	456	49680-20.....	463/3	51260-00.....	469	53250-08.....	473
47620-05.....	450	49315-10.....	456	49685-21.....	463/3	51270-00.....	470	53260-01.....	473
47620-06.....	450	49317-00.....	456	49691-15.....	463/3	51270-01.....	470	53260-02.....	473
47630-00.....	450	49317-01.....	456	49692-15.....	463/3	51270-02.....	470	53260-03.....	473
47630-01.....	450	49317-02.....	456	49694-25.....	463/4	51270-03.....	470	53260-04.....	473
47630-02.....	450	49317-03.....	456	49694-25CL.....	463/4	51270-04.....	470	53260-05.....	473
47630-03.....	450	49317-04.....	456	49695-01.....	463/5	51290-02.....	470	53260-06.....	473
47630-04.....	450	49320-00.....	457	49695-02.....	463/5	51290-05.....	470	53260-07.....	473
47636-01.....	450	49320-01.....	457	49696-18.....	463/6	51290-10.....	470	53260-08.....	473
47636-02.....	450	49320-02.....	457	49700-01.....	464	51290-20.....	470	53270-08.....	473
47636-03.....	450	49320-03.....	457	49700-02.....	464	51291-00.....	470	53270-10.....	473
47636-04.....	450	49320-10.....	457	49705-08.....	464/1	51292-00.....	470	53270-12.....	473
47641-01.....	450	49320-20.....	457	49705-12.....	464/1	51293-00.....	470	53270-14.....	473
47641-02.....	450	49340-00.....	457	49705-16.....	464/1	51293-45.....	470	53270-16.....	473
47641-03.....	450	49342-01.....	458	49705-20.....	464/1	51293-90.....	470	53270-18.....	473
47642-01.....	450	49342-02.....	458	49710-04.....	464/2	53101-22.....	471	53270-20.....	473
47642-02.....	450	49342-03.....	458	49710-06.....	464/2	53102-20.....	471	53270-22.....	473
47642-03.....	450	49342-04.....	458	49710-08.....	464/2	53103-22.....	471	53270-24.....	473
49102-16.....	451	49342-05.....	458	49711-04.....	464/2	53111-18.....	471	53270-26.....	473
49103-17.....	451	49345-01.....	458	49711-06.....	464/2	53115-01.....	471	53270-28.....	473
49104-15.....	451	49345-02.....	458	49713-06.....	464/2	53115-02.....	471	53270-30.....	473
49105-16.....	451	49345-03.....	458	49713-08.....	464/2	53115-03.....	471	53272-08.....	473
49106-01.....	451	49345-04.....	458	51103-18.....	465	53115-04.....	471	53272-10.....	473
49106-02.....	451	49345-05.....	458	51103-20.....	465	53121-24.....	471	53272-12.....	473
49107-19.....	451	49360-10.....	459	51103-22.....	465	53130-00.....	472	53272-14.....	473
49108-15.....	451	49400-01.....	459	51109-24.....	465	53131-20.....	472	53272-16.....	473
49109-19.....	451	49501-22.....	459	51111-23.....	465	53132-20.....	472	53272-18.....	473
49110-19.....	452	49501-23.....	459	51131-22.....	465	53132-30.....	472	53272-20.....	473
49111-15.....	452	49501-24.....	459	51133-23.....	465	53132-40.....	472	53272-22.....	473
49115-01.....	452	49503-22.....	459	51134-21.....	465	53132-50.....	472	53272-24.....	473
49115-02.....	452	49503-23.....	459	51135-01.....	465	53132-60.....	472	53272-26.....	473
49117-11.....	452	49503-24.....	459	51135-02.....	465	53150-00.....	472	53272-28.....	473
49119-14.....	453	49605-07.....	460	51139-25.....	465	53152-00.....	472	53272-30.....	473
49230-11.....	453	49605-10.....	460	51143-24.....	465	53154-00.....	472	53274-12.....	473
49231-12.....	453	49605-11.....	460	51151-19.....	465	53155-00.....	472	53276-10.....	473
49231-14.....	453	49605-12.....	460	51165-22.....	466	53157-00.....	472	53280-01.....	474
49231-16.....	453	49605-14.....	460	51167-22.....	466	53158-02.....	472	53280-02.....	474
49235-19.....	453	49605-16.....	460	51168-23.....	466	53158-03.....	472	53280-03.....	474
49250-16.....	453	49610-12.....	460	51169-23.....	466	53160-02.....	472	53280-04.....	474
49250-18.....	453	49610-13.....	460	51170-24.....	466	53160-03.....	472	53280-05.....	474
49255-16.....	453	49610-16.....	460	51171-22.....	466	53162-00.....	472	53280-06.....	474
49255-99.....	453	49613-10.....	461	51172-19.....	466	53164-01.....	472	53280-07.....	474
49265-12.....	454	49615-12.....	461	51173-21.....	466	53164-02.....	472	53280-08.....	474
49265-14.....	454	49620-15.....	461/1	51174-21.....	466	53166-00.....	472	53280-09.....	474
49267-12.....	454	49623-16.....	461/1	51177-23.....	466	53170-00.....	472	53280-10.....	474
49270-16.....	454	49627-01.....	461/1	51178-21.....	466	53175-00.....	472	53280-11.....	474
49270-19.....	454	49630-02.....	461/1	51179-17.....	466	53177-01.....	472	53290-01.....	475
49272-13.....	454	49631-00.....	461/2	51181-19.....	467	53177-02.....	472	53290-02.....	475
49274-09.....	454	49635-18.....	462	51183-19.....	467	53230-01.....	473	53290-03.....	475
49274-11.....	454	49640-05.....	462	51185-19.....	467	53230-02.....	473	53290-04.....	475

53290-05.....475	57244-13.....483	61021-24.....499	61063-16.....512	61372-08.....523
53290-06.....475	57245-13.....484	61022-01.....499	61138-14.....513	61372-09.....523
53290-07.....475	57246-16.....484	61022-02.....499	61138-16.....513	61373-01.....523
53290-08.....475	57246-21.....484	61022-24.....499/1	61138-18.....513	61373-02.....523
55111-13.....476	57247-95.....485	61022-28.....499/2	61138-20.....513	61373-03.....523
55111-14.....476	57248-14.....485	61023-25.....500	61139-14.....513	61373-04.....523
55113-14.....476	57249-01.....485	61023-26.....500	61139-16.....513	61373-05.....523
55115-07.....476	57251-15.....486	61024-01.....501	61139-18.....513	61373-06.....523
55116-15.....476	57252-19.....486	61024-02.....501	61139-20.....513	61373-07.....523
55117-17.....476	57260-02.....487	61024-24.....501/1	61140-17.....514	61373-08.....523
55118-16.....477	57260-03.....487	61024-27.....501/2	61141-16.....514	61373-09.....523
55119-16.....477	57260-04.....487	61025-20.....502	61143-15.....514	61374-01.....523
55120-15.....477	57260-06.....487	61025-24.....502	61145-15.....514	61374-02.....523
55122-16.....477	57260-09.....487	61025-25.....502	61147-17.....514	61374-03.....523
55124-16.....477	57264-16.....487	61025-26.....502	61149-17.....515	61374-04.....523
55151-05.....477	57265-00.....487/1	61025-27.....502	61151-17.....515	61374-05.....523
55151-07.....477	57266-13.....488	61026-01.....503	61153-16.....515	61374-06.....523
55151-09.....477	57270-00.....489	61026-02.....503	61153-17.....515	61374-07.....523
55220-04.....479	57270-65.....489	61026-03.....503	61156-16.....515	61374-08.....523
55220-05.....479	57270-75.....489	61026-04.....503	61156-17.....515	61374-09.....523
55220-06.....479	57270-80.....489	61027-23.....504	61156-18.....515	61460-15.....524
55220-07.....479	57280-19.....489/1	61027-25.....504	61157-17.....516	61460-19.....524
55220-08.....479	57283-14.....489/1	61029-25.....504	61158-10.....516	61461-15.....524
55220-09.....479	57284-16.....489/1	61030-21.....505	61158-11.....516	61461-19.....524
55220-10.....479	57286-16.....489/1	61030-22.....505	61158-12.....517	61461-28.....525
55220-11.....479	57288-30.....489	61031-17.....505	61159-12.....517	61462-19.....524
55220-12.....479	57289-32.....489	61032-18.....506	61159-13.....517	61462-28.....525
55220-13.....479	57290-20.....490	61032-20.....506	61161-14.....517	61463-19.....524
55240-04.....479	57291-20.....490	61032-23.....506	61161-18.....517	61463-28.....525
55240-05.....479	57301-30.....490	61032-25.....506	61161-19.....517	61464-15.....524
55240-06.....479	57307-24.....490	61033-23.....506	61172-15.....518	61464-19.....524
55240-07.....479	57309-22.....490	61033-24.....506	61173-16.....518	61464-28.....525
55240-08.....479	57311-22.....490	61033-25.....506	61174-17.....518	61465-15.....524
55240-09.....479	57313-22.....490	61034-21.....507	61175-17.....518	61465-19.....524
55240-10.....479	57321-23.....491	61034-23.....507	61176-17.....518	61465-28.....525
55240-11.....479	57323-23.....491	61034-27.....507	61177-17.....518	61466-15.....524
55240-12.....479	57325-15.....491	61034-31.....507	61178-16.....519	61466-19.....524
55240-13.....479	57327-26.....491	61035-21.....507	61178-17.....519	61466-28.....525
55501-15.....479	57329-26.....491	61035-23.....507	61179-18.....519	61467-15.....524
55503-15.....479	61000-21.....492	61035-27.....507	61180-17.....519	61467-19.....524
55511-21.....479	61000-22.....492	61035-31.....507	61187-16.....519	61467-28.....525
55520-15.....479	61001-21.....492	61036-18.....508	61187-17.....519	61468-19.....524
55520-20.....479	61001-22.....492	61036-19.....508	61188-20.....520	61468-28.....525
55523-17.....479	61003-21.....492	61036-23.....508	61189-21.....520	61469-19.....524
57102-23.....480	61003-22.....492	61036-27.....508	61190-17.....520	61469-28.....525
57105-22.....480	61005-22.....493	61037-20.....508	61191-16.....520	61470-15.....524
57107-22.....480	61007-22.....493	61037-21.....508	61192-17.....520	61470-19.....524
57111-21.....480	61008-19.....493	61037-25.....508	61193-01.....520/1	61471-15.....524
57123-35.....480	61008-23.....493	61037-29.....508	61193-02.....520/1	61471-19.....524
57125-35.....480	61009-16.....494	61038-12.....509	61193-03.....520/1	61471-28.....525
57126-34.....481	61010-18.....494	61039-00.....509/1	61193-04.....520/1	61472-19.....524
57131-26.....481	61011-19.....494	61039-12.....509	61193-05.....520/1	61472-28.....525
57137-27.....481	61011-20.....494	61039-15.....509/1	61194-26.....520/2	61473-19.....524
57138-21.....481	61012-17.....495	61039-30.....509/1	61195-28.....520/2	61473-28.....525
57141-36.....481	61012-18.....495	61039-45.....509/1	61195-32.....520/3	61481-15.....524
57146-28.....481	61012-19.....495	61039-90.....509/1	61196-26.....520/4	61481-19.....524
57147-28.....481	61013-18.....495	61040-21.....510	61259-15.....521	61482-15.....524
57210-16.....482	61013-19.....495	61041-00.....509/1	61261-16.....521	61482-19.....524
57210-20.....482	61013-20.....495	61041-15.....509/1	61263-16.....521	61482-28.....525
57210-25.....482	61014-15.....495/1	61041-30.....509/1	61266-01.....522	61483-19.....524
57214-75.....482	61014-18.....495/1	61041-45.....509/1	61266-02.....522	61483-28.....525
57230-13.....482	61015-15.....495/2	61041-90.....509/1	61266-03.....522	61484-19.....524
57230-17.....482	61015-18.....495/2	61045-18.....511	61266-04.....522	61484-28.....525
57230-18.....482	61016-20.....495/2	61046-19.....511	61266-05.....522	61488-16.....526
57234-75.....482	61017-26.....496	61050-01.....510	61372-01.....523	61489-16.....526
57236-20.....483	61017-27.....496	61050-02.....510	61372-02.....523	61490-15.....526
57236-25.....483	61017-31.....496	61050-03.....510	61372-03.....523	61491-15.....526
57236-30.....483	61017-33.....496	61050-04.....510	61372-04.....523	61492-16.....526
57242-20.....483	61018-28.....497	61050-05.....510	61372-05.....523	61493-01.....527
57242-25.....483	61019-30.....498	61050-07.....510	61372-06.....523	61493-02.....527
57242-30.....483	61020-27.....498	61062-16.....512	61372-07.....523	61493-03.....527

61495-01.....527	63170-23.....533	65211-23.....540	67122-23.....551	67206-21.....554
61495-02.....527	63173-01.....533	65216-13.....540	67123-23.....551	67206-22.....554
61495-03.....527	63173-02.....533	65216-16.....540	67125-24.....551	67206-23.....554
61495-04.....527	63173-03.....533	65216-18.....540	67130-00.....552	67206-24.....554
61700-01.....528	63173-04.....533	65216-21.....540	67130-01.....552	67206-25.....554
61700-33.....528	63173-05.....533	65216-23.....540	67130-02.....552	67206-26.....554
61710-01.....528	63173-06.....533	65217-13.....540	67130-03.....552	67206-27.....554
61710-33.....528	63173-07.....533	65217-16.....540	67132-00.....552	67206-28.....554
61715-04.....528	63173-08.....533	65217-18.....540	67147-27.....552	67206-29.....554
61715-05.....528	63174-00.....268	65217-21.....540	67149-27.....552	67206-30.....554
61715-06.....528	63175-27.....534	65217-23.....540	67150-00.....552	67207-08.....554
61810-05.....529	63178-01.....534	65220-13.....540	67155-00.....552	67207-09.....554
61810-10.....529	63178-03.....534	65220-22.....540	67160-00.....552	67207-10.....554
61810-15.....529	63180-17.....534	65220-25.....540	67163-00.....553	67207-11.....554
61810-20.....529	63180-21.....534	65220-28.....540	67165-00.....553	67207-12.....554
61810-25.....529	63180-24.....534	65221-13.....540	67169-00.....553	67207-13.....554
61810-30.....529	63180-27.....534	65221-22.....540	67169-01.....553	67207-14.....554
61810-35.....529	63210-32.....534	65221-25.....540	67172-20.....553/1	67207-15.....554
61810-40.....529	63231-01.....535	65221-28.....540	67172-28.....553/1	67207-16.....554
61810-45.....529	63231-02.....535	65226-22.....540	67175-08.....553/1	67207-17.....554
61810-50.....529	63231-03.....535	65226-25.....540	67177-11.....553/1	67207-18.....554
61810-70.....529	63231-04.....535	65226-28.....540	67178-12.....553/2	67207-19.....554
61810-90.....529	63231-05.....535	65227-22.....540	67178-14.....553/2	67207-20.....554
61820-05.....529	63231-06.....535	65227-25.....540	67179-14.....553/2	67207-21.....554
61820-10.....529	63232-01.....536	65227-28.....540	67184-39.....554	67207-22.....554
61820-15.....529	63232-02.....536	65230-21.....541	67185-35.....554	67207-23.....554
61820-20.....529	65102-12.....537	65230-23.....541	67201-08.....554	67207-24.....554
61820-25.....529	65102-14.....537	65230-25.....541	67201-10.....554	67207-25.....554
61820-30.....529	65108-15.....537	65231-21.....541	67201-12.....554	67207-26.....554
61820-35.....529	65110-15.....537	65231-23.....541	67201-14.....554	67207-27.....554
61820-40.....529	65120-15.....537	65231-25.....541	67201-16.....554	67207-28.....554
61820-45.....529	65120-19.....537	65236-25.....541	67201-18.....554	67207-29.....554
61820-50.....529	65120-22.....537	65237-25.....541	67201-20.....554	67207-30.....554
61820-70.....529	65120-24.....537	65238-33.....541	67201-22.....554	67211-06.....555
61820-90.....529	65124-16.....537	65239-33.....541	67201-24.....554	67211-08.....555
61910-01.....530	65124-20.....537	65241-23.....542	67201-26.....554	67211-10.....555
61910-02.....530	65124-22.....537	65242-30.....542	67201-28.....554	67211-12.....555
61910-03.....530	65124-25.....537	65255-19.....543	67201-30.....554	67211-14.....555
61910-04.....530	65124-30.....537	65256-19.....543	67201-32.....554	67211-16.....555
61920-14.....530/1	65130-15.....537	65259-24.....543	67201-34.....554	67211-18.....555
61920-23.....530/1	65132-16.....538	65260-24.....543	67201-36.....554	67211-20.....555
61930-18.....530/1	65132-20.....538	65261-15.....544	67205-08.....554	67211-22.....555
61930-21.....530/1	65140-15.....538	65262-12.....544	67205-10.....554	67211-24.....555
63101-23.....530/2	65140-19.....538	65263-15.....544	67205-12.....554	67213-06.....555
63103-23.....530/2	65145-15.....538	65263-20.....544	67205-14.....554	67213-08.....555
63106-20.....530/2	65150-20.....538	65265-26.....545	67205-16.....554	67213-10.....555
63107-20.....530/2	65154-18.....538	65265-28.....545	67205-18.....554	67213-12.....555
63110-20.....530/2	65155-18.....538	65270-15.....545	67205-20.....554	67213-14.....555
63111-20.....530/2	65155-20.....538	65272-07.....545	67205-22.....554	67213-16.....555
63117-22.....530/2	65160-14.....539	65272-10.....545	67205-24.....554	67213-18.....555
63125-28.....531	65160-16.....539	65274-00.....545	67205-26.....554	67213-20.....555
63130-13.....531	65160-18.....539	65280-05.....546	67205-28.....554	67213-22.....555
63130-18.....531	65160-20.....539	65280-07.....546	67205-30.....554	67213-24.....555
63130-21.....531	65160-24.....539	65280-10.....546	67205-32.....554	67219-08.....555
63142-34.....531	65164-16.....539	65282-26.....546	67205-34.....554	67219-10.....555
63150-00.....532	65164-20.....539	65284-08.....546	67205-36.....554	67219-12.....555
63150-01.....532	65168-16.....539	65284-23.....546	67205-38.....554	67219-14.....555
63150-02.....532	65168-20.....539	65290-30.....547	67205-40.....554	67219-16.....555
63150-03.....532	65170-18.....539	65291-30.....547	67206-08.....554	67219-18.....555
63150-04.....532	65170-20.....539	65310-15.....548	67206-09.....554	67219-20.....555
63150-05.....532	65172-20.....539	65310-21.....548	67206-10.....554	67219-22.....555
63150-06.....532	65172-23.....539	65310-29.....548	67206-11.....554	67219-24.....555
63150-07.....532	65174-20.....539	65310-35.....548	67206-12.....554	67220-00.....555
63150-08.....532	65178-19.....539	65320-00.....549	67206-13.....554	67220-12.....555
63150-09.....532	65178-23.....539	67101-21.....550	67206-14.....554	67220-14.....555
63150-10.....532	65180-16.....539	67103-22.....550	67206-15.....554	67220-16.....555
63150-11.....532	65210-18.....540	67105-21.....550	67206-16.....554	67220-18.....555
63150-12.....532	65210-21.....540	67105-22.....550	67206-17.....554	67220-20.....555
63150-13.....532	65210-23.....540	67106-20.....550	67206-18.....554	67220-22.....555
63170-21.....533	65211-18.....540	67110-23.....550	67206-19.....554	67220-24.....555
63170-22.....533	65211-21.....540	67111-23.....550	67206-20.....554	67220-26.....555

67220-28.....555	69302-42.....566	71241-02.....572	71362-24.....577	71424-08.....579
67220-30.....555	69303-28.....566	71241-03.....572	71363-24.....577	71424-13.....579
67220-32.....555	69303-35.....566	71241-10.....572	71364-24.....577	71425-08.....579
67220-34.....555	69303-42.....566	71242-00.....572	71365-24.....577	71426-08.....579
67220-36.....555	69304-28.....566	71242-01.....572	71404-14.....578	71426-13.....579
67220-38.....555	69304-35.....566	71242-02.....572	71404-26.....578	71430-10.....580
67240-08.....556	69304-42.....566	71242-03.....572	71405-14.....578	71430-12.....580
67240-11.....556	69311-23.....567	71242-10.....572	71406-14.....578	71430-14.....580
67240-13.....556	69311-33.....567	71260-01.....573	71406-26.....578	71430-16.....580
67240-16.....556	69311-40.....567	71260-02.....573	71410-01.....578	71430-18.....580
67240-21.....556	69321-23.....567	71261-01.....573	71410-02.....578	71430-20.....580
67240-26.....556	69321-33.....567	71261-02.....573	71410-03.....578	71436-06.....580
67240-32.....556	69321-40.....567	71262-01.....573	71410-04.....578	71438-00.....580
67250-07.....556	69402-21.....567	71262-02.....573	71410-05.....578	71438-13.....580
67251-07.....556	69402-25.....567	71271-01.....573	71410-06.....578	71438-17.....580
69105-22.....559	69450-18.....568	71271-02.....573	71410-07.....578	71438-21.....580
69110-15.....559	69455-00.....568	71271-03.....573	71410-08.....578	71438-25.....580
69115-15.....559	69456-00.....568	71281-01.....573	71410-09.....578	71438-29.....580
69121-00.....559	69457-12.....568	71281-02.....573	71410-10.....578	71438-33.....580
69125-17.....559	69457-31.....568	71281-03.....573	71410-11.....578	71438-37.....580
69126-01.....560	69458-00.....568	71291-00.....573	71410-12.....578	71438-41.....580
69126-02.....560	69458-10.....568	71291-01.....573	71410-13.....578	71441-34.....581
69126-03.....560	69458-11.....568	71291-02.....573	71410-14.....578	71443-29.....581
69127-01.....560	69458-16.....568	71291-03.....573	71410-15.....578	71445-29.....581
69127-02.....560	69460-00.....568	71300-01.....574	71410-16.....578	71500-18.....582
69127-03.....560	71100-00.....569	71301-01.....574	71410-17.....578	71502-25.....582
69130-19.....560	71110-01.....570	71301-02.....574	71410-18.....578	71503-25.....582
69142-06.....560	71110-02.....570	71301-03.....574	71410-19.....578	71504-25.....582
69142-08.....560	71110-03.....570	71303-01.....574	71410-20.....578	71505-24.....582
69142-12.....560	71115-02.....569	71303-02.....574	71410-21.....578	71507-28.....582
69147-00.....561	71115-03.....569	71303-03.....574	71410-22.....578	71508-17.....582
69147-01.....561	71116-02.....570	71303-04.....574	71410-23.....578	71510-18.....582
69147-02.....561	71120-00.....570	71303-05.....574	71410-24.....578	71512-20.....583
69147-03.....561	71120-01.....570	71305-01.....574	71410-25.....578	71512-28.....583
69147-04.....561	71120-02.....570	71305-02.....574	71410-26.....578	71514-24.....583
69148-00.....561	71120-03.....570	71305-03.....574	71410-27.....578	71515-24.....583
69150-15.....561	71130-01.....570	71305-04.....574	71410-28.....578	71524-06.....583
69210-22.....562	71130-02.....570	71305-05.....574	71410-29.....578	71524-08.....583
69212-16.....562	71130-03.....570	71306-00.....575	71410-30.....578	71524-10.....583
69212-19.....562	71132-00.....570	71306-01.....575	71415-01.....578	71525-06.....583
69212-22.....562	71140-01.....570	71306-02.....575	71415-02.....578	71525-08.....583
69220-05.....562	71140-02.....570	71306-03.....575	71415-03.....578	71525-10.....583
69220-10.....562	71140-03.....570	71306-04.....575	71415-04.....578	71531-23.....583
69220-14.....562	71142-04.....570	71306-05.....575	71415-05.....578	71532-21.....583
69220-20.....562	71150-01.....571	71306-06.....575	71415-06.....578	71533-21.....583
69224-21.....563	71150-02.....571	71306-07.....575	71415-07.....578	71536-21.....584
69224-27.....563	71150-03.....571	71306-08.....575	71415-08.....578	71536-28.....584
69225-22.....563	71160-01.....571	71307-00.....576	71415-09.....578	71537-27.....584
69225-30.....563	71160-02.....571	71308-00.....576	71415-10.....578	71539-26.....584
69226-25.....564	71160-03.....571	71308-01.....576	71415-11.....578	71540-27.....585
69226-29.....564	71161-17.....571	71308-02.....576	71415-12.....578	71542-20.....585
69226-38.....564	71161-25.....571	71308-03.....576	71415-13.....578	71543-32.....585
69227-01.....565	71170-01.....571	71308-04.....576	71415-14.....578	71545-27.....585
69227-02.....565	71170-02.....571	71309-00.....576	71415-15.....578	71547-23.....585
69227-03.....565	71170-03.....571	71310-20.....577	71415-16.....578	71549-25.....585
69227-04.....565	71210-01.....572	71310-25.....577	71415-17.....578	71559-26.....586
69227-05.....565	71210-02.....572	71310-30.....577	71415-18.....578	71565-28.....586
69227-06.....565	71210-03.....572	71310-35.....577	71415-19.....578	71567-26.....586
69228-01.....565	71211-01.....572	71310-40.....577	71420-01.....579	71580-32.....586
69229-01.....565	71211-02.....572	71313-20.....577	71420-03.....579	71581-32.....586
69229-02.....565	71211-03.....572	71313-25.....577	71420-05.....579	71582-32.....586
69251-01.....563	71212-01.....572	71313-30.....577	71420-07.....579	71583-32.....586
69251-02.....563	71212-02.....572	71313-35.....577	71420-09.....579	71584-28.....586
69251-03.....563	71212-03.....572	71313-40.....577	71420-11.....579	71585-25.....586
69261-41.....566	71240-00.....572	71315-40.....577	71420-13.....579	71590-04.....587
69263-30.....566	71240-01.....572	71319-28.....577	71420-15.....579	71592-01.....587
69301-28.....566	71240-02.....572	71319-38.....577	71420-17.....579	71592-02.....587
69301-35.....566	71240-03.....572	71351-10.....477/577	71420-19.....579	71592-03.....587
69301-42.....566	71240-10.....572	71351-15.....477/577	71420-21.....579	71592-04.....587
69302-28.....566	71241-00.....572	71360-24.....577	71420-23.....579	71593-00.....587
69302-35.....566	71241-01.....572	71361-24.....577	71420-25.....579	71594-40.....587

71596-40.....587	71703-02.....595	71725-16.....597	73147-36.....603/2	75379-10.....610
71598-27.....587	71703-03.....595	71725-19.....597	73148-17.....603/2	75382-16.....610
71604-01.....588	71703-04.....595	71725-20.....597	73151-29.....604	75396-01.....611
71604-02.....588	71703-05.....595	71727-05.....597	73155-44.....604	75396-02.....611
71604-21.....588	71703-06.....595	71727-06.....597	73157-40.....604	75397-00.....611
71604-28.....588	71704-27.....595	71727-07.....597	73162-40.....604	75400-01.....612
71605-26.....588	71710-05.....597	71727-08.....597	73170-00.....604	75400-02.....612
71606-24.....588	71710-06.....597	71727-09.....597	73171-21.....604	75400-03.....612
71611-25.....588	71710-07.....597	71727-11.....597	73181-33.....605	75400-04.....612
71612-21.....588	71710-08.....597	71727-12.....597	73183-27.....605	75410-01.....612
71613-28.....589	71710-09.....597	71727-14.....597	73184-21.....605	75410-02.....612
71615-01.....589	71710-11.....597	71727-15.....597	73187-09.....605	75410-03.....612
71615-02.....589	71710-12.....597	71727-16.....597	73189-09.....605	75410-04.....612
71617-04.....589	71710-14.....597	71727-19.....597	73191-34.....605	75410-15.....612/1
71618-23.....589	71712-05.....597	71727-20.....597	73193-30.....605	75420-15.....612/1
71619-23.....589	71712-06.....597	71730-30.....597	73195-35.....605	75430-01.....612/1
71621-01.....590	71712-07.....597	71730-35.....597	73242-27.....606	75430-12.....612
71621-01-25.....590	71712-08.....597	71730-40.....597	73243-27.....606	75430-13.....612
71622-00.....590	71712-09.....597	71732-30.....597	73244-01.....606	75440-00.....612
71622-00-25.....590	71712-11.....597	71732-35.....597	73244-02.....606	75440-11.....612/1
71623-00.....590	71712-12.....597	71732-40.....597	73244-03.....606	75445-12.....612/1
71623-00-25.....590	71712-14.....597	71735-30.....597	73245-01.....606	75450-00.....612
71624-01.....591	71715-05.....597	71735-35.....597	73245-02.....606	75450-13.....612/2
71624-03.....591	71715-06.....597	71735-40.....597	73245-03.....606	75460-13.....612/2
71624-04.....591	71715-07.....597	71736-00.....599	73252-30.....606	75470-11.....612/2
71624-05.....591	71715-08.....597	71736-07.....599	73254-14.....606	75475-11.....612/2
71624-06.....591	71715-09.....597	71736-08.....599	73254-18.....606	75480-13.....612/2
71624-07.....591	71715-11.....597	71736-09.....599	73254-21.....606	75485-13.....612/2
71624-08.....591	71715-12.....597	71736-10.....599	73256-42.....607	75490-15.....612/2
71624-09.....591	71715-14.....597	71736-11.....599	73259-28.....607	75500-15.....612/2
71624-10.....591	71717-05.....597	71736-12.....599	73302-42.....607	75550-13.....613
71624-11.....591	71717-06.....597	71737-06.....599	73304-46.....607	75600-10.....613
71624-13.....591	71717-07.....597	71737-08.....599	73306-25.....607	75618-15.....613
71624-14.....591	71717-08.....597	71737-10.....599	73309-30.....607	75620-15.....613
71624-15.....591	71717-09.....597	71737-12.....599	75103-15.....608	75630-12.....614
71624-16.....591	71717-11.....597	71737-14.....599	75111-10.....608	75640-15.....614
71624-17.....591	71717-12.....597	71737-30.....597	75113-14.....608	89111-25.....615
71624-18.....591	71717-14.....597	71737-35.....597	75115-14.....608	89111-32.....615
71624-19.....591	71720-05.....597	71737-40.....597	75118-14.....608	89112-65.....615
71626-00.....592	71720-06.....597	71803-03.....600	75121-10.....608	89113-65.....615
71626-00-25.....592	71720-07.....597	71803-04.....600	75128-01.....608	89114-00.....615
71627-00.....592	71720-08.....597	71803-06.....600	75128-02.....608	89115-50.....615
71628-00.....592	71720-09.....597	71803-08.....600	75128-03.....608	89115-65.....615
71628-00-25.....592	71720-11.....597	71803-10.....600	75128-04.....608	89115-75.....615
71630-00.....590	71720-12.....597	71803-12.....600	75128-05.....608	89116-50.....615
71632-00.....593	71720-14.....597	71803-14.....600	75128-06.....608	89116-65.....615
71634-00.....593	71720-15.....597	71803-15.....600	75129-01.....608	89116-75.....615
71635-26.....593	71720-16.....597	71810-12.....601	75129-02.....608	89121-40.....617
71641-17.....594	71720-19.....597	71810-16.....601	75129-03.....608	89121-50.....617
71643-27.....594	71720-20.....597	71810-20.....601	75129-04.....608	89122-16.....617
71645-01.....594	71722-05.....597	71810-50.....601	75129-05.....608	89122-21.....617
71645-02.....594	71722-06.....597	73101-23.....602	75129-06.....608	89122-26.....617
71645-03.....594	71722-07.....597	73102-30.....602	75130-01.....608	89122-30.....617
71646-01.....594	71722-08.....597	73105-33.....602	75130-02.....608	89124-23.....618
71646-02.....594	71722-09.....597	73105-36.....602	75130-03.....608	89124-26.....618
71650-00.....596	71722-11.....597	73107-30.....602	75138-00.....608	89124-27.....618
71650-01.....596	71722-12.....597	73108-36.....602	75140-02.....608	89124-30.....618
71650-02.....596	71722-14.....597	73108-39.....602	75140-03.....608	89124-32.....618
71650-03.....596	71722-15.....597	73110-41.....602	75140-04.....608	89124-42.....618
71650-04.....596	71722-16.....597	73115-32.....603	75140-05.....608	89125-23.....618
71650-05.....596	71722-19.....597	73115-38.....603	75140-06.....608	89125-26.....618
71650-06.....596	71722-20.....597	73119-36.....603	75140-07.....608	89125-30.....618
71650-07.....596	71725-05.....597	73119-40.....603	75140-08.....608	89125-32.....618
71660-00.....596	71725-06.....597	73123-39.....603	75301-10.....609	89125-42.....618
71702-01.....594	71725-07.....597	73125-40.....603	75304-10.....609	89126-23.....618
71702-02.....594	71725-08.....597	73127-40.....603	75305-10.....609	89126-26.....618
71702-03.....594	71725-09.....597	73135-36.....603	75331-14.....609	89126-27.....618
71702-04.....594	71725-11.....597	73139-40.....603/1	75341-11.....609	89126-30.....618
71702-05.....594	71725-12.....597	73141-39.....603/1	75341-13.....609	89126-32.....618
71702-06.....594	71725-14.....597	73143-39.....603/1	75373-10.....610	89126-42.....618
71703-01.....595	71725-15.....597	73145-36.....603/1	75378-10.....610	89127-04.....619

89127-06.....619	89155-13.....622	91010-03.....628	91801-21.....634
89127-08.....619	89155-15.....622	91010-11.....628	91801-25.....634
89127-11.....619	89155-19.....622	91010-12.....628	98000-01.....635
89127-12.....619	89159-14.....622	91010-13.....628	98000-02.....635
89127-14.....619	89159-16.....622	91010-14.....628	R190.03.....622
89127-16.....619	89159-19.....622	91010-15.....628	R190.05.....622
89127-18.....619	89159-24.....622	91010-16.....628	R190.07.....622
89127-23.....618	89164-14.....622	91010-17.....628	R190.10.....622
89127-26.....618	89164-16.....622	91010-18.....628	R191.03.....622
89127-30.....618	89164-19.....622	91010-21.....628	R191.05.....622
89127-32.....618	89164-24.....622	91010-31.....628	R191.07.....622
89127-42.....618	89164-29.....622	91010-33.....628	R191.10.....622
89129-11.....619	89164-34.....622	91010-34.....628	R390.03.....622
89133-16.....619	89164-39.....622	91010-35.....628	R390.05.....622
89133-17.....619	89169-14.....622	91010-36.....628	R390.07.....622
89133-22.....619	89169-16.....622	91011-51.....629	R390.10.....622
89133-24.....619	89169-19.....622	91011-52.....629	
89133-31.....619	89169-24.....622	91011-53.....629	
89133-34.....619	89169-29.....622	91011-54.....629	
89133-38.....619	89169-34.....622	91011-55.....629	
89139-17.....619	89169-39.....622	91011-56.....629	
89139-25.....619	89174-14.....622	91011-61.....629	
89139-27.....619	89174-16.....622	91011-62.....629	
89140-02.....620	89174-19.....622	91020-01.....629	
89140-05.....620	89174-24.....622	91020-02.....629	
89140-10.....620	89174-29.....622	91020-03.....629	
89140-20.....620	89174-34.....622	91020-04.....629	
89141-10.....620	89174-39.....622	91022-05.....629	
89142-01.....620	89179-14.....622	91022-10.....629	
89142-02.....620	89179-16.....622	91022-20.....629	
89142-03.....620	89179-19.....622	91024-10.....629	
89142-04.....620	89179-24.....622	91024-15.....629	
89142-05.....620	89179-29.....622	91024-20.....629	
89142-06.....620	89179-34.....622	91030-02.....629	
89142-07.....620	89179-39.....622	91030-04.....629	
89143-00.....621	89179-49.....622	91030-06.....629	
89143-01.....621	89179-59.....622	91102-11.....630	
89143-02.....621	89250-10.....623	91104-11.....630	
89143-03.....621	89250-20.....623	91109-11.....630	
89143-04.....621	89250-30.....623	91113-11.....630	
89143-05.....621	89250-40.....623	91115-11.....630	
89143-06.....621	89250-50.....623	91122-16.....630	
89143-07.....621	89250-60.....623	91123-16.....630	
89143-08.....621	89256-29.....623	91124-16.....630	
89143-09.....621	89256-46.....623	91125-16.....630	
89143-10.....621	89256-67.....623	91127-16.....630	
89145-23.....620	89257-46.....623	91142-16.....631	
89145-30.....620	89260-13.....624	91144-16.....631	
89145-31.....620	89260-17.....624	91146-16.....631	
89145-35.....620	89260-20.....624	91152-19.....631	
89146-20.....268/621	89260-25.....624	91154-19.....631	
89147-10.....621	89260-30.....624	91157-19.....631	
89147-21.....620	89260-40.....624	91159-19.....631	
89147-24.....620	89265-12.....624	91162-19.....632	
89147-25.....621	89270-15.....624	91164-19.....632	
89147-30.....620	89500-00.....626	91166-19.....632	
89147-31.....620	89500-01.....626	91167-19.....632	
89147-35.....620	89500-02.....626	91169-19.....632	
89147-40.....620	89500-03.....626	91172-03.....632	
89147-42.....620	89500-04.....626	91172-07.....632	
89148-25.....621	89500-05.....626	91172-12.....632	
89148-31.....621/1	89500-06.....626	91190-30.....633	
89148-32.....621/1	89500-07.....626	91190-50.....633	
89148-35.....621/1	89500-08.....626	91192-30.....633	
89148-50.....621	89500-09.....626	91192-50.....633	
89150-30.....621/1	89500-10.....626	91193-30.....633	
89152-08.....622	89500-11.....626	91193-50.....633	
89152-10.....622	89500-12.....626	91800-18.....634	
89152-12.....622	89501-03.....626	91800-21.....634	
89155-08.....622	91010-01.....628	91800-25.....634	
89155-10.....622	91010-02.....628	91801-18.....634	

Abfallzange, SAUERBRUCH	227	anatomische Pinzette, CUSHING-TAYLOR	87	Arterienklemme, KELLY-RANKIN	106
Abortuskürette, PESTALOZZA	606	anatomische Pinzette, DUEHRSEN	84	Arterienklemme, KOCHER	108
Abortuslöffel, CUZZI	606	anatomische Pinzette, GERALD	86, 87	Arterienklemme, LAHEY	119/2
Abortuslöffel, WALLICH	607	anatomische Pinzette, McINDOE	85	Arterienklemme, LAWRENCE	119
Abortuszange, SAENGER	606	anatomische Pinzette, OCHSNER	88	Arterienklemme, LERICHE	111
Abortuszange, WINTER	606	anatomische Pinzette, POTTS-SMITH	81	Arterienklemme, LOVEFACE	109
ABRAHAM, Tonsillenfasszange	468	anatomische Pinzette, SEMKEN	86	Arterienklemme, LOWER	120
ABRAHAM, Tonsillennmesser	466	anatomische Pinzette, STILLE	81	Arterienklemme, MAYO-GUYON	122
Absauganlage f. Gipssäge	231	anatomische Pinzette, TAYLOR	87	Arterienklemme, MEEKER	119
Absaugküretten	600	anatomische Pinzette, TC	81	Arterienklemme, Micro-HARTMANN	104
Absaugrohr, BUIE	566	anatomische Pinzette, USA	81	Arterienklemme, MIXTER	116, 119/1
Absaugrohr, KLEINSASSER	36	anatomische Pinzette, WANGENSTEEN	89	Arterienklemme, MIXTER-BABY	119/1
ADAIR, Hakenzange	582	ANDERSON, Wundhaken	198	Arterienklemme, MOYNIHAN	120
ADLERKREUTZ, Gefäßspinzette	84	ANDREW, Zungendrucker	452	Arterienklemme, O'SHAUGNESSY	119/2
ADSON, anatomische Pinzette	81/2	ANDREW-PYNCHON, Saugrohr	28	Arterienklemme, OVERHOLT	114
ADSON, Arterienklemme	112	Anestrophon	23	Arterienklemme, OVERHOLT-BABY	114
ADSON, chirurgische Pinzette	81/2	Aneurysmaklemme, DeBAKEY-BAHNSON	506	Arterienklemme, OVERHOLT-GEISSENDOERFER	114
ADSON, Durahaken	329	Anlegepinzette, MEHDORN	362	Arterienklemme, OVERHOLT-MIXTER	115
ADSON, Halteklammer	298	Anlegezange	357 - 360	Arterienklemme, PEAN	108, 110
ADSON, Hohlmeißelzange	236	Anlegezange, JOHNS-HOPKINS	104	Arterienklemme, PENNINGTON	109
ADSON, Hypophysepinzette	334	Anlegezange, McKENZIE	326	Arterienklemme, PROVIDENCE-HOSPITAL	106
ADSON, Nadelhalter	211	Anlegezange, OLIVECRONA-TOENNIS	326	Arterienklemme, ROBERTS	117
ADSON, Raspator	282	Anlegezange, RANEY	327	Arterienklemme, ROCHESTER-CARMALT	109
ADSON, Saugrohr	337	Anlegezange, SMITHWICK	326	Arterienklemme, ROCHESTER-OCHSNER	108
ADSON, Wundspreizer	172 - 174	Anlegezange, SWEET	326	Arterienklemme, ROCHESTER-PEAN	108
ADSON-BABY, Arterienklemme	113	ANTRUM, Kürette	435	Arterienklemme, RUMEL	117
ADSON-BABY, Wundspreizer	173	Antrumkürette, COAKLEY	449	Arterienklemme, SAROT	118
ADSON-BROWN, chirurgische Pinzette	82	Antrumraspel, GALLAHER	446	Arterienklemme, SPENCER-WELLS	109
ADSON-Micro, anatomische Pinzette	81/2	Antrumraspel, WIENER	443	Arterienklemme, STILLE	122
ADSON-Micro, chirurgische Pinzette	82	Anuskop, HIRSCHMANN	562	Arterienklemme, TOENNIS	117
AEBLI, Ophthalmologie-Schere	58	Anuskop, IVES-FANSLER	562	Arterienklemme, WIKSTROEM	117
Ahle, OBWEGESER	463, 463/3	Anuskop, KELLY	562, 563	Arterienklemme, ZENKER	118
AIR-INJECTION, Augenkantüle	394	ANVIL, Nagelspaltzange	613	ASCH, Septumrichtungzange	449
ALAN-PARKS, Mastdarm-Spekula	561	Aorta-Aneurysmaklemme, DeBAKEY	496 - 498	Atrauma-Arterienklemme	492 - 527
ALDERDYCE, Elevator	282	Aortahaken, ROSS	148/1	Atrauma-Arterienklemme, DeBAKEY-MOSQUITO	509
ALEXANDER, Biopsiezange	589	Aortaklemme, DeBAKEY	499, 500	Atrauma-Arterienklemme, DeBAKEY-PEAN	513
ALEXANDER, Flachmeißel	259	Aortaklemme, DIETRICH	510	Atrauma-Arterienklemme, DeBAKEY-RANKIN	512
ALEXANDER, Hohlmeißel	259	Aortaklemme, MORRIS-DeBAKEY	506	Atrauma-Bulldogklemme, DeBAKEY	103
ALEXANDER, Raspator	276	Aortaklemme, WEBER	501	Atrauma-Bulldogklemme, GLOVER	103
ALEXANDER, Uterus-Biopsiezange	589	Aortaklemme, WYLIE	501/1	Atrauma-Darmfaßzange	539
ALLEN, Blinddarmklemme	544	Aortastanze	528	Atrauma-Neonataklammer	523
ALLIS, Darmfasszange	537	Approximator, BIEMER	366	Atrauma-Pinzette, DeBAKEY	98
ALLIS-ADAIR, Darmfasszange	537	Approximator, BIEMER-MÜLLER	363	Atrauma-Pinzette, DeBAKEY TC	99
ALLIS-BABY, Darmfasszange	537	Approximator, MÜLLER	364	Atrauma-Gefäßklemme, BECK	516
ALLISON, Lungenspatel	489/2	ARCHER, Splitterzange	92	AUFFRANC-COBRA, Knochenhebel	289
ALM, Wundhaken	168	ARLT, Starschlinge	378	AUFFRANC-COBRA, Wundhaken	289
ALU, Stimmgabeln	403	Armsystem	188, 189	Aufreiber, KUENTSCHER	321
ALVIS, Fremdkörperkürette	374	ARRUGA, Extraktionshaken	375	AUFRICHT, Nasenhaken	447
Amnioskop	601	ARRUGA, Kapselpinzette	391	AUFRICHT, Nasenraspel	443
Amniotom, BEACHAM	586	ARRUGA, Lidsperrer	370	Aufsatz, BARACANI	472
Amputationsmesser, CATLIN	44	ARRUGA, Nadelhalter	214	Aufsatz, BRUENINGS	472
Amputationsmesser, LANGENBECK	44	ARRUGA, Wundlöffel	378	Aufsatz, CORDES	472
Amputationsmesser, LISTON	44	Arterienklemme, ADSON	112	Aufsatz, FRAENKEL	472
Amputationsmesser, HADEO	44	Arterienklemme, ADSON-BABY	113	Aufsatz, KRAUSE	472
Amputationssäge, BIER	296	Arterienklemme, BAINBRIDGE	119/2	Aufsatz, LANGE	472
Amputationssäge, CHARRIERE	296	Arterienklemme, BENGOLEA	112	Aufsatz, Reinigungspistole	626
Amputationssäge, SATTERLEE	296	Arterienklemme, BIRKETT	116	Aufsatz, SCHEINMANN	472
Anal spreizer, SMITH-BUIE	561	Arterienklemme, CRAFOORD-SELLORS	119	Aufsatz, SCHUMACHER	472
Anastomosenklemme, BECK	516, 520	Arterienklemme, CRILE	107	Aufsatz, SEIFERT	472
Anastomosenklemme, COOLEY	520/1, 520/4	Arterienklemme, CRILE-RANKIN	107	Aufsatz, SLUDER-BALLENGER	470
Anastomosenklemme, COOLEY-DERRA	519	Arterienklemme, DANDY	109	Aufsatz, Uterus-Biopsiezangen	591
Anastomosenklemme, DeBAKEY	505	Arterienklemme, DESJARDINS	121	Augenkantüle	394
Anastomosenklemme, DeMARTEL-WOLFSON	546	Arterienklemme, FUCHSIG	113	Augenkantüle, AIR-INJECTION	394
Anastomosenklemme, DERRA	515	Arterienklemme, GEMINI	115	Augenkantüle, JENSEN	394
Anastomosenklemme, LAMBERT-KAY	505	Arterienklemme, GRAY	121	Augenkantüle, LACRIMAL	394
Anastomosenklemme, POTTS	493	Arterienklemme, GUYON	122	Augenkantüle, McINTYRE	394
anatomische Pinzette	81, 86	Arterienklemme, HALSTED-MOSQUITO	105	Augenkantüle, SHEETS	394/2
anatomische Pinzette, ADSON	81/2	Arterienklemme, HARTMANN	104	Augenmagnet, HADEO	395
anatomische Pinzette, ADSON-DeBAKEY	81/2	Arterienklemme, HEISS	112	Augenpinzetten	382 - 393
anatomische Pinzette, ADSON-Micro	81/2	Arterienklemme, JACOBSON	105	Augenschere, BARRAQUER	75
anatomische Pinzette, BONNEY	88	Arterienklemme, JOHNS-HOPKINS	120	Augenschere, NOYES	75
anatomische Pinzette, BROPHY	84	Arterienklemme, KANTROWITZ	119/1	Augenschere, VANNAS	79
anatomische Pinzette, CUSHING	83	Arterienklemme, KELLY	106	Augenschere, WECKER	75

Augenschere, WESTCOTT	75	Bauchdeckenhalter, DENIS-BROWNE	185	Biopsiezange, KEVORKIAN	589, 591
Aurikelklemme, HARKEN	503	Bauchdeckenhalter, DOYEN	189/1	Biopsiezange, KEVORKIAN-PACIFIC	592
Autopsiesäge	230, 230/2	Bauchdeckenhalter, FRAZIER	181	Biopsiezange, MAXI GRASPER	593
AUVARD, Scheidenspekula	576	Bauchdeckenhalter, GELPI	189/1, 189/2	Biopsiezange, MINI-TOWNSEND-DOWN	591
AXENFELD, Chazalionskürlette	377	Bauchdeckenhalter, GOSSET	181	Biopsiezange, MINI-TOWNSEND-UP	591
AYER, Chazalionspinzette	393	Bauchdeckenhalter, HORGAN	183	Biopsiezange, SCHUBERT	588
B		Bauchdeckenhalter, JACKSON-BURROWS	189/2	Biopsiezange, SCHUMACHER	588, 589
BABCOCK, Darmfasszange	539	Bauchdeckenhalter, KIRSCHNER	185 - 187/1	Biopsiezange, THOMAS-GAYLOR	588
BABINSKI, Perkussionshammer	24	Bauchdeckenhalter, O'SULLIVAN-O'CONNOR	181	Biopsiezange, TISCHLER-BABY	592
BABY-BURKE, Uterus-Biopsiezange	590	Bauchdeckenhalter, RICARD	191	Biopsiezange, TISCHLER-DOWN	591
BABY-GOSSET, Bauchdeckenhalter	181	Bauchdeckenhalter, RIGBY	189/2	Biopsiezange, TISCHLER-KEVORKIAN	592
BABY-KOCHER, Darmklemme	540	Bauchdeckenhalter, ROCHARD	186	Biopsiezange, TISCHLER-MORGAN	590, 591
BABY-METZENBAUM, Supercuttschere	71	Bauch- u. Darmspatel	143/2	Biopsiezange, TISCHLER-UP	591
BABY-OLSEN-HEGAR, Nadelhalter	212	Bauch- u. Darmspatel, KADER	143/1	Biopsiezange, TOWNSEND	591
BABYPHON, Blutdruckmessgerät	10	Bauch- u. Darmspatel, KÖRTE	143/1	Biopsiezange, VAN DOREN	588
BABY-TISCHLER, Uterus-Biopsiezange	592	Bauch- u. Darmspatel, KÜMMEL	143/4, 144	Biopsiezange, WITNER	589
BABY-WEBSTER, Nadelhalter	208	Bauch- u. Darmspatel, LERICHE	143/4	Bipolare Koagulation	630 - 633
BABY-YANKAUER, Saugrohr	27	BAUMGÄRTNER, Nadelhalter	208	Bipolarkabel	633
BACKHAUS, Tuchklemme	132	BEACHAM, Amniotom	586	Bipolare Pinzette	630 - 632
BACKHAUS-CLIP, Tuchklemme	132	BECHERT, Linsenmanipulator	379	BIRCHER-GANSKE, Knochenhaltezange	246
BALILEY-BABY, Rippenkontraktor	489/1	BECK, Anastomosenklemme	516, 520	BIRKETT, Arterienklemme	116
BALILEY-GIBBON, Rippenkontraktor	489/1	BECKENKIRK, COLLIER	605	BLAKE, Gallensteinzange	386
BAILEY, Rippenkontraktor	489/1	BECKENKIRK, COLLIN	605	BISHOP-HARMON, Spül- und Saugkanüle	394/1
BAINBRIDGE, Arterienklemme	119/2	Beckenkirkel, MARTIN	605	Blätter-Wechselpinzette	179
BAINBRIDGE, Mehrzweck-Gefäßsklemme	495/1, 495/2	BECKER, Cystotom	375	BLAKE, Gallensteinzange	530/2
BAKES, Gallengangdilator	532	BECKMANN, Ringmesser	450	BLAKE, Uteruskürlette	595
BALFOUR-BABY, Bauchdeckenhalter	182	BECKMANN, Wundspreizer	176	Blasenhalssperrer, MILLIN	553
BALFOUR, Bauchdeckenhalter	182	BECKMANN-ADSON, Wundspreizer	175	Blasenspatel, KOCHER	552
BALFOUR, Haken	193	BECKMANN-EATON, Wundspreizer	176	Blasenspatel, LEGUEU	552
BALFOUR-US, Bauchdeckenhalter	184	BEEBEE, Kronenschere	68	Blasenwundspreizer, JUDD-MASSON	552
BALFOUR, Valve f. Bauchdeckenhalter	183	BEER, Cilienpinzette	395	Blasenwundspreizer, LEGUEU	553
BALL AND SOCKET, Tuchklemme	133	BEESON, Gipsspreizer	232	Blasenwundspreizer, MILLIN	552
BALLENGER, Schwingmesser	436	Begrenzungsscheibe	230/17	Blasenwundspreizer, THOMSON-WALKER	552
BALLENGER, Septumlevator	439	Beinhautmesser	47	Blattosteotom, OBWEGESER	464/1
BALLENGER, Tonsillenzange	467	Beleuchtungsstab f. MORGAN	565	Bleiband	250
Bandmass	25	BELLUCCI, Mikro-Ohrscheren	413, 417	Blinddarmklemme, ALLEN	544
Bandscheibenstanze, COLCLOUGH	344/1	BENSAUDE, Proktoskoper	322/1	Blinddarmklemme, KLEINSCHMIDT	544
Bandscheibenstanze, FERRIS-SMITH-KERRISON	344, 344/2	BENGOLEA, Arterienklemme	112	BLOHMKE, Tonsillenzange	467
BANE-HARTMANN, Hohlmeisselzange	237	BENNETT, Knochenheber	283	BLOUNT, Knochenheber	288
BANGERTER, Zykliodials spatel	379	BENSAUDE, Proktoskoper	565	BLOUNT, Meniskushaken	289
BARACANI, Aufsatz	472	BENSON, Pylorusspreizer	544	BLUMENTHAL, Hohlmeisselzange	236
BARANY, Lärmtrommel	405	BERENS, Diszisionsmesser	372	Blutdruckmessgerät, BABYPHON	10
BARBARA, Hähchen	419	BERGMANN, Hammer	272	Blutdruckmessgerät, DIPLOMAT	5
BARBARA, Nadel	419	BERGMANN, Verbandschere	69/1	Blutdruckmessgerät, EXACTA	8
BARKAN, Goniotomiemesser	373	BERKE, Muskelpinzette	389	Blutdruckmessgerät, PRECISA	9
BARNHILL, Ringmesser	450	BERLINER, Perkussionshammer	24	Blutschöpföfifel	268
BARON, Saugrohr	336	BERNHARD, Tuchklemme	133	Blutstillungsmeißel, PASSOW	260
BARR, Mastdarmspekula	559	BERRY, Drahtzange	319	BÖHLER, Hohlmeisselzange	238
BARRAQUER, Augenschere	75	Beschheidungsgerät, MOGEN	556	BÖHLER, Knochen splitterzange	241
BARRAQUER, Cilienpinzette	395	Beschheidungsinstrument	556	BODENHAMMER, Mastdarmspekula	559
BARRAQUER, Fixationspinzette	390	BETHUNE, Rippenschere	481	BOEHLER, Extensionsbügel	312
BARRAQUER, Irispinzette	384	BETHUNE, Hohlmeisselzange	237	BOERMA, Geburtszange	604
BARRAQUER, Keratoplastik-Messer	373	Biegeeisen, BENDER	322	BOETTCHER, Tonsillenschere	59
BARRAQUER, Lidsperrer	370	Biegehebel, LANE	325	Bohrapparat, STILLE-SHERMAN	298
BARRAQUER, Nadelhalter	216, 217	BIEMER, Approximator	366	Bohrdraht, KIRSCHNER	306, 307
BARRAQUER-KATZIN, Irispinzette	384	BIEMER, Gefäßclip	361	Bohrdrahtspender	305, 310
BARRAQUER-TROUTMAN, Nadelhalter	216	BIEMER-MÜLLER, Approximator	363	Bohrdrahtstütze	299
BARRET, Hakenzange	582	BIER, Amputationssäge	296	Bohrer	298, 302
BARTON, Geburtszange	603/2	BILL, Zughebel	604	Bohrer, CRUTCHFIELD	327
BARTON, Zughebel	603/2	BILLEAU, Ohrschlinge	409	Bohrer, ERRICO	299
Batteriegriff, Kaltlicht	33	Biopsie- und Absaugkürlette	600	Bohrer, MCKENZIE	299
Batteriegriff, Warmlicht	32	Biopsiekanüle, MENGHINI	206	BOIES, Elevator	277
Bauch- u. Darmspatel	143/1 - 143/4	Biopsiekürlette	600	Bolzenschneider	320
Bauch- u. Darmspatel, KÜMMEL	143/4	Biopsiekürlette, HEANY	587	BONACCOLTO, Strabismuspinzette	385
Bauchdeckenhalter, BABY-GOSSET	181	Biopsiekürlette, KEVORKIAN	587	BONN, Irispinzette	387
Bauchdeckenhalter, BALFOUR	182	Biopsiekürlette, MOD. MÜNCHEN	587	BONNEY, Pinzette	88
Bauchdeckenhalter, BALFOUR-BABY	182	Biopsiekürlette, NOVAK	587	BOSE, Trachealhaken	477
Bauchdeckenhalter, BALFOUR-US	184	Biopsiekürlette, RANDALL	587	BOSE, Trachelspreizer	476
Bauchdeckenhalter, CHARNELY	289	Biopsiezange, ALEXANDER	589	BOUCHERON, Ohrspekula	399
Bauchdeckenhalter, COLLIN	190	Biopsiezange, BABY-TISCHLER	592	BOWMAN, Diszisionsnadel	374
Bauchdeckenhalter, COLLIN-LOKTITE	191	Biopsiezange, BURKE	590	BOWMAN, Lidsperrer	370
Bauchdeckenhalter, DeBAKEY	189/1	Biopsiezange, EPPENDORFER	590	BOWMAN, Tränenkanalsonde	381
		Biopsiezange, FAURE	588	BOYNTON, Nadelhalter	214

BOYS-ALLIS, Darmfaßzange	538	Carotis-Shuntklemme, JAVID	511	Cilienpinzette, BEER	395
BOZEMANN, Nadelhalter	211	CARPENTER, Tonsillenelevator	465	Cilienpinzette, DOUGLAS	395
BOZEMANN, Tamponzange	138	CARPENTER, Tonsillennmesser	465	Cilienpinzette, GRADLE	395
BOZEMANN-DOUGLAS, Tamponzange	138	Cartilageschere, MARTIN	65/1	Cilienpinzette, LITTAUER	395
BRAND, Sehnenfassinstrument	293	CASPAR, Laminektomiespreizer	179, 180	Cilienpinzette, HADEO	395
BRAND, Sehnenschäler	294	CASPAR, Spreizer	197	CINELLI, Septummeißel	441
BRAUN, Dekapitationshaken	607	CASPAR, Stößel	258	Circumcisionsgerät	556
BRAUN, Hakenzange	582	CASPAR, Wundspreizer	179, 180	CITELLI, Knochenstanze	430
BRAUN, Kranioklast	607	CASTANEDA, Neonatal-Gefäßklemme	527	CLAR, Stirnlampe	22
BRAUN, Uterusdepressor	586	CASTROVIEJO, Disziionsmesser	372	CLARK, Lidsperre	370
BRAUN-STADLER, Episotomie-Schere	64	CASTROVIEJO, Fixierpinzette	390	CLAUS, Tonsillennadel	466
BREAST, Wundhaken	198	CASTROVIEJO, Hornhautschere	79	CLAUS-EICKEN, Tonsillennadel	466
BREISKY, Scheidenspekula	577	CASTROVIEJO, Kapselpinzette	391	CLAYMAN, Häkchen	376
Breiten-Messinstrument	594	CASTROVIEJO, Klingenbrecher	45	CLEVELAND, Hohlmeißelzange	235
BRISTOW, Knochenhebel	290	CASTROVIEJO, Lidsperre	371	Cliplanlegezange, ETHICON	524, 525
BRODIE, Hohlonde	199	CASTROVIEJO, Messzirkel	380	Cliplanlegezange, HORIZON	524, 525
Bronchoskopiezeange, CHEVALIER-JACKSON	473	CASTROVIEJO, Nadelhalter	215, 216	Cliplanlegezange, PILLING	524, 525
Bronchusklemme	126	CASTROVIEJO, Nahtpinzette	392	Cliplanlegezange, SLS Clips	524, 525
Bronchusklemme, FINOCCHIETTO	490	CASTROVIEJO, Tränenkanal dilatator	381	CLOWARD, Laminektomiezeange	342
Bronchusklemme, HARRINGTON	490	CASTROVIEJO, Zyklodialysespatel	379	CLOWARD, Wirbelkörperspreizer	339
Bronchusklemme, LEES	504	CASTROVIEJO-Micro, Nadelhalter	215	CLOWARD, Wundsperrerr	178/1 - 178/4
Bronchusklemme, PRICE-THOMAS	490	CASTROVIEJO-STANDARD, Nadelhalter	216	COAKLEY, Antrumkürette	449
Bronchusklemme, SEMB	491	CATLIN, Amputationsmesser	44	COAKLEY, Kieferhöhlentraker	204
BROPHY, Pinzette	84	Cauter, WADSWORTH-TODD	378	Coarctationsklemme, DeBAKEY	507
BROWN, Gewebepinzette	83	CAWOOD-MINNESOTA, Wangenhalter	451	Coarctationsklemme, POTTS	492
BROWN, Nadelhalter	209	Cervicalspreizer, CLOWARD	178/1 - 179	COBB, Hohlmeißel	262
BRUENINGS, Aufsatz	472	Chalazionskürette, AXENFELD	377	COBB, Kürette	252
BRUENINGS, Ohrspekula	401	Chalazionskürette, HEBRA	377	COBB, Raspator	280
BRUENINGS, Septumzange	425	Chalazionskürette, MEYHOEFFER	377	COBB, scharfer Löffel	252
BRUENINGS, Tonsillennmesser	466	Chalazionspinzette, AYER	393	COLCLOUGH, Bandscheibenstanze	344/1
BRUENINGS, Tonsillenschneider	468	Chalazionspinzette, DESMARRS	393	COLLER-CRILE, Arterienklemme	106
BRUENINGS, Verlängerungsrohr	472	Chalazionspinzette, LAMBERT	393	COLLIER, Beckenzirkel	605
BRUENINGS, Zungenspatel	451	CHANDLER, Elevator	282	COLLIER, Nadelhalter	208
BRÜNINGS-LUCAS, Flachmeißel	260	CHAPUT, Gewebefasszange	110	COLLIN, Bauchdeckenhalter	190
BRUNETTI, Meißel	268	CHARNLEY, Bauchdeckenhalter	289	COLLIN, Beckenzirkel	605
BRUNNER, Darmklemme	543	CHARRIERE, Amputationssäge	296	COLLIN, Darmfasszange	539
BRUNNER, Führungshohlsonde	221/1	CHEATLE, Sterilisierzange	227	COLLIN, Dynamometer	25
BRUNNER, Rippenschere	481	CHELSEA-EATON, Proktoskop	563	COLLIN, Gewebefasszange	110
BRUNNER, Wundhaken	167	CHERON, Tupferzange	137	COLLIN, Hammer	270
BRUNS, scharfer Löffel	251	CHERRY, Laminektomiesperre	488	COLLIN, Nabelschnurklemme	605
BRUNS, Verbandschere	70	CHEVALIER-JACKSON, Bronchoskopiezeange	473	COLLIN, Scheidenspekula	570
Bruststütze, KLEINSASSER	36	CHEVALIER-JACKSON, Trachealkanüle	479	COLLIN, Sonde	586
Bruststütze, NEGUS	459	CHILDE, Wundklammerzange	224	COLLIN, Tupferzange	137
BRYANT, Tupferzange	137	chirurgische Nadel	222	COLLIN, Uterus-Fasszange	585
BUCHWALD, Zungenspatel	451	chirurgische Nadel, KEITH	223	COLLIN, Uterussonde	586
BUCK, Fremdkörperhebel	412	chirurgische Nadel, KOENIG	223	COLLIN, Wundhaken	139
BUCK, Ohrkürette	407	chirurgische Pinzette	81/1	COLLIN, Wundklammerzange	224
BUCK, Perkussionshammer	24	chirurgische Pinzette, ADLERKREUZ	84	COLLIN, Zungenzange	453
BUCK-GRAMCKO, Knochenhebel	285	chirurgische Pinzette, ADSON	81/2, 82	COLLIN-DUVAL, Fasspinzette	85
BUIE, Rektal-Absaugrohr	566	chirurgische Pinzette, ADSON-BROWN	82	COLLIN-HARTMANN, Wundhaken	141
Bulldogklemme, atrauma	100	chirurgische Pinzette, ADSON-Micro	82	COLLIN-LOKITE, Bauchdeckenhalter	191
Bulldogklemme, DeBAKEY	103	chirurgische Pinzette, BONNEY	88	Columella-Pinzette, COTTLE	448
Bulldogklemme, GLOVER	103	chirurgische Pinzette, BROPHY	84	COLVER, Tonsillenfasszange	467
Bulldogklemme, JOHNS-HOPKINS	104	chirurgische Pinzette, BROWN	83	CONE, Schädelstanze	331
BÜLOW-GUNAR-HEY, Rollenklemme	130	chirurgische Pinzette, CUSHING	83	CONNIN-AMSLER, Markierungsinstrument	380
BUMM, Uteruskürette	597, 598	chirurgische Pinzette, FERRIS-SMITH	85	CONVERSE, Nasenhaken	448
BUNELL, Handbohrapparat	299	chirurgische Pinzette, GERALD	87	CONVERSE, Nasenmesser	435
BUNELL, Sehnenführer	294	chirurgische Pinzette, GILLIES	86	COOLEY, Anastomosenklemme	520/1
BUNELL, Sehnenschäler	292	chirurgische Pinzette, LANE	84	COOLEY, Aortaklemme	520/3
BUNGE, Exenterationsöffel	378	chirurgische Pinzette, LERCHE	83	COOLEY, Gefäßklemme	520/1 - 520/4
BUNT, Sterilisierklammer	227, 624	chirurgische Pinzette, McINDOE	85	COOLEY, Katheterklemme	510
BURCH, Fixiergabel	373	chirurgische Pinzette, OEHLER	81/1	COOLEY, Kinder-Gefäßsklammern	522
BURKE, Uterus-Biopsiezeange	590	chirurgische Pinzette, POTTS-SMITH	81	COOLEY, Mehrzweck-Gefäßklemme	518 - 520
Bürstenspender	611	chirurgische Pinzette, SEMKEN	86	COOLEY, Rippensperre	485, 487
BUSCH, Nabelschnurschere	64	chirurgische Pinzette, Standard	81/1	COOLEY, Saugrohr	28
BUSHE, scharfer Löffel	256	chirurgische Pinzette, STILLE	81/1	COOLEY, Wundhaken	148
C		chirurgische Pinzette, STILLE-BARRAYA	88	COOLEY-DERRA, Anastomosenklemme	519
CANFIELD, Tonsillennmesser	466	chirurgische Pinzette, STRASSBURGER MODELL	89	COOLEY-NEONATAL, Rippensperre	485
CAPLAN, Nasenzange	428	chirurgische Pinzette, TAYLOR	87	COOPER, Unterbindungsadel	219
Cardiovascular-Klemme	526	chirurgische Pinzette, WAUGH	83	CORDES, Aufsatz	472
CARMALT, Splitterpinzette	91	chirurgische Schere, DEEVER	52	CORONAL-BROW, Wundhaken	198
CAROLL, Sehnenfaßinstrument	293	chirurgische Schere, STANDARD	51	CORWIN-HEGAR, Drahtzange	319
		Cilienpinzette, BARRAQUER	395	CORYLLOS, Rippenschere	480

CORYLLOS, Wundhaken	166	Darmklemme, FEHLAND	542	DEMELE, Drahtspanninstrument	315
COS, Mikro-Ohrzängchen	414	Darmklemme, HAYES	545	DEMELE, Drahtumführungsnaedel	315
COTTLE, Bulldoggschere	56	Darmklemme, KOCHER	540	DENHART, Mundsperrer	454
COTTLE, Columella-Pinzette	448	Darmklemme, LANE	547	DENIS-BROWNE, Bauchdeckenhalter	185
COTTLE, Fixierpinzette	410	Darmklemme, MAYO-ROBSON	541	DERF, Nadelhalter	208
COTTLE, Hammer	273	Darmklemme, MIKULICZ	543	Dermatom, HUMBY	50
COTTLE, Hauthäkchen	447/1, 448	Darmklemme, PAYR	548	Dermatom, SCHINK	49
COTTLE, Knorpelquetscher	440	Darmklemme, RESANO	542	Dermatom, SILVER	50
COTTLE, Nasenhaken	447, 447/1	Darmklemme, SCUDDER	541	Dermatom, WATSON	50
COTTLE, Nasenmesser	435	Darmklemme, STONE-WATT	545	DERRA, Anastomosenklemme	515
COTTLE, Nasenschere	59	Darmschere	66	D'ERRICO, Nervwurzelhaken	329/2
COTTLE, Nasenspekula	423	Darmspatel	143/1 - 143/4	DESCHAMPS, Unterbindungsnaedel	218
COTTLE, Osteotom	440	Darmspatel, HABERER	143/3	DESJARDINS, Arterienklemme	121
COTTLE, Schere	56	Darmspatel, KADER	143/3	DESJARDINS, Gallensteinlöffel	534
COTTLE, Septumelevator	439	Darmspatel, KÖRTE	143/3	DESJARDINS, Gallensteinsonde	531
COTTLE, Septummeißel	440	Darmspatel, KÜMMEL	143/4	DESJARDINS, Gallensteinzange	530/2
COTTLE-JOSEPH, Septumelevator	439	Darmspatel, LERICHE	143/4	DESMARRES, Chalazionspinzette	393
COTTLE-KAZANJIAN, Knochen splitterzange	241	Darmspatel, REVERDIN	143/3	DESMARRES, Wundhaken	151
COTTLE-NEIVERT, Hauthäkchen	448	Darmspatel, RIBBON	143/1	DEUTSCHMANN, Starmesser	371
COXETER, Metallkatheter	555	Darm- u. Gewebefasszange, GREGOIRE	538	DeVILBISS, Schädelzange	332
CRAFOORD, Arterienklemme	118	DARTIGUES, Uterusfasszange	585	Diagnostik-Besteck ECO "C"	16
CRAFOORD, Lungenschere	65/2	DASTOOR, Strabismuspinzette	386	Diagnostik-Besteck ECO "T"	16
CRAFOOD-SELLORS, Arterienklemme	119	DAUBENSPECK, scharfer Löffel	255	Diagnostik-Besteck, RI-MINI	17
CREGO, Elevator	282	DAVIDSON (SCAPULA), Wundhaken	166	Diagnostik-Besteck, UNI III	15
CRILE, Arterienklemme	107	DAVIEL, Starlöffel	377	DIFFENBACH, Gefäßklemme	104
CRILE, Nadelhalter	213	DAVIS, Duradisektor	332	DIETER, Mikro-Ohrzängchen	414
CRILE, Nervhaken	328	DAVIS, Fremdkörpernaedel	374	DIETRICH, Aortaklemme	510
CRILE, Wundhaken	140	DAVIS, Hirnspatel	337	DIETRICH, Gefäßschere	60
CRILE-MURRAY, Nadelhalter	209	DAVIS, Sterilisierpinzette	227	DIETRICH, Mini-Bulldogklemme	101
CRILE-RANKIN, Arterienklemme	107	DAVIS-BOYLE, Mundsperrer	455	Dilatationsbougie, DITTEL	554
CRILE-WOOD, Nadelhalter	209	DAVIS-BOYLE, Sperrer	455	Dilatationsbougie, GUYON	554
CRITCHETT, Lidsperrer	370	DAVIS-BOYLE, Zugendrucker	455	Dilatationsbougie, VAN BUREN	554
CRUTCHFIELD, Bohrer	327	DAVIS-MEYER, Mundsperrer	457	Dilatator, BAKES	532
CRUTCHFIELD, Schädelhalter	327	DAY, Häkchen	409	Dilatator, CASTROVIEJO	381
CUSCO, Scheidenspekula	570, 571	DEAN, Irismesser	372	Dilatator, DeBAKEY	529
CUSHING, Bohrer	299	DEAN, Tonsillenschere	59	Dilatator, GOODELL	581
CUSHING, Hirnspatel	336, 369	DEAVER, Präparierschere	52	Dilatator, HANK	580
CUSHING, Laminektomie zange	340	DEAVER, Wundhaken	145, 146	Dilatator, HEGAR	578, 579
CUSHING, Nerven haken	328	DEAVER-GRIP, Wundhaken	146	Dilatator, PRATT	580
CUSHING, Pinzette	83, 87	DeBAKEY, Anastomosenklemme	505	Dilatator, RITTER-HALLE	433
CUSHING, Wundhaken	151, 152	DeBAKEY, Aorta-Aneurysmaklemme	496 - 498	Dilatator, SIMS	581
CUSHING (TAYLOR), Pinzette	87	DeBAKEY, Aortaklemme	499, 500	Dilatator, WALTHER	555
CUZZI, Abortuslöffel	606	DeBAKEY, Atrauma-Bulldogklemme	103	Dilatator, WILDER	381
Cystotom, BECKER	375	DeBAKEY, Atrauma-Pinzette	98, 99	Dilatator, WYLIE	581
Cystotom, GRAEFE	375	DeBAKEY, Bauchdeckenhalter	189/1	Dilatator, ZIEGLER	381
CZERNY, Hakenzange	584	DeBAKEY, Coarctationsklemme	507	DINGMANN, Elevator	463/3
CZERNY, Mastdarm-Spekula	559	DeBAKEY, Gefäßdilator	529	DINGMANN, Knochenhalte zange	246
CZERNY, Wundhaken	141	DeBAKEY, Gefäßklemme	493 - 499	DINGMANN, Mundsperrer	456
		DeBAKEY, Gefäßschere	61	DINGMANN, Raspator	463, 463/3
D		DeBAKEY, Ligaturklemme	499 - 500	DINGMANN, Sperrer	456
DALE, Gefäßklemme	494, 495	DeBAKEY, Mehrzweck-Gefäßklemme	495, 508, 514 - 517	DIPLOMAT, Blutdruckmeßgerät	5
DANDY, Arterienklemme	109	DeBAKEY, Nadelhalter	210	Dissektor, FISCH	420
DANDY, Nerven haken	328	DeBAKEY, Nadelhalter	28	Dissektor, GORNEY	277
DARDIK, Gefäßklemme	509/1	DeBAKEY, Saugrohr	502	Dissektor, ROBB	530
DARLING, Wundspreizer	178	DeBAKEY, Tangentialklemme	502	Dissektor, PENFIELD	333
Darmfasszange, ALLIS	537	DeBAKEY-BAHNSON, Aneurysmaklemme	506	Disziionsmesser, BERENS	372
Darmfasszange, ALLIS-ADAIR	537	DeBAKEY-DIETHRICH, Mini-Bulldogklemme	101	Disziionsmesser, CASTROVIEJO	372
Darmfasszange, ALLIS-BABY	537	DeBAKEY-MIXTER, Präparier- u. Ligaturklemme	499/2	Disziionsmesser, GRAEFE	372
Darmfasszange, atrauma	539	DeBAKEY-MOSQUITO, Atrauma-Arterienklemme	509	Disziionsmesser, WHEELER	373
Darmfasszange, BABCOCK	539	DeBAKEY-PEAN, Atrauma-Arterienklemme	513	Disziionsmesser, ZIEGLER	373
Darmfasszange, BOYS-ALLIS	538	DeBAKEY-RANKIN, Atrauma-Arterienklemme	512	Disziionsnaedel	374
Darmfasszange, COLLIN	539	DeBAKEY-RUMEL, Gefäßklemme	499	Disziionsnaedel, BOWMAN	374
Darmfasszange, DOYEN-BABY	540	DeBAKEY-SATINSKY, Tangentialklemme	502	DITTEL, Dilatationsbougie	554
Darmfasszange, DUVAL	539	DeBOER, Rippensperrer	486	DIX, Fremdkörper flachmeißel	374
Darmfasszange, JUDD-ALLIS	538	DECKER, Rongeur	341	DIX, Fremdkörperinstrument	380
Darmfasszange, LITTLEWOOD	538	DEJERINE, Perkussionshammer	24	Doppelkürlette	612
Darmfasszange, LOCKWOOD-ALLIS	538	DeLEE, Geburtszange	602	Doppelöffel, VOLKMANN	257
Darmfasszange, THOMS-ALLIS	538	DeLEE, Scheidenspekula	574	DOUGHTY, Zungenspatel	458
Darmfasszange, WILLIAMS	539	DeMARTEL, Führungsinstrument	330	DOUGLAS, Cilienpinzette	395
Darmklemme, BABY-KOCHER	540	DeMARTEL-WOLFSON, Anastomosenklemme	546	DOUGLAS, Kieferhöhlentrommel	204
Darmklemme, BRUNNER	543	DeMARTEL-WOLFSON, Darmklemme	546	DOUGLAS, Tonsillensmesser	466
Darmklemme, DeMARTEL-WOLFSON	546	DeMARTEL-WOLFSON, Klemmenhalterung	546	DOYEN, Bauchdeckenhalter	189/1
Darmklemme, DOYEN	540	DeMARTEL-WOLFSON, Klemmenschiesszange	546	DOYEN, Darmklemme	540

DOYEN, Hohlsonde.....	199	Elevator, DINGMAN.....	463, 463/3	Fadenpinzette, Mod. TUEBINGEN.....	392
DOYEN, Myomheber.....	594	Elevator, DINGMANN.....	463/3	Fadenpinzette, PAUFIQUE.....	392
DOYEN, Raspator.....	278	Elevator, FREER.....	434, 437, 439	Fadenschere, HEATH.....	66
DOYEN, Scheidenspekula.....	574	Elevator, HAJEK-BALLENGER.....	439	Fadenschere, LITTAUER.....	66
DOYEN, Schere.....	63	Elevator, HALLE.....	437	Fadenschere, NORTHBENT.....	66
DOYEN, Tuckklemme.....	133	Elevator, HOWARTH.....	438	Fadenschere, SPENCER.....	66
DOYEN, Uterus-Polypenzange.....	585	Elevator, JOSEPH.....	437	FANSLER, Proktoskop.....	564
DOYEN, Wundhaken.....	163	Elevator, KEY.....	282	FARABEUF, Knochenhaltezange.....	243
DOYEN-BABY, Darmklemme.....	540	Elevator, KILLIAN.....	438, 439	FARABEUF, Raspator.....	274
DOYEN-JANSEN (MOLT), Mundsperrer.....	454	Elevator, LEMPERT.....	420	FARABEUF, Wundhaken.....	139
DOYEN-STILLE, Wundhaken.....	167	Elevator, MASING.....	437	FARABEUF-COLLIN, Raspator.....	274
Drahtbogen, ERICH.....	461/2	Elevator, McDONALD.....	283	FARABEUF-LAMBOTTE, Knochenhaltezange.....	243
Drahtfasszange.....	316, 318	Elevator, McKENTY.....	437	FARRELL, Watteträger.....	203
Drahtgeflecht.....	311	Elevator, MURPHY-LANE.....	283	Fasspinzette.....	305
Drahtkneifzange.....	317 - 320/3	Elevator, OBWEGESER.....	461/1	Fasspinzette, COLLIN-DUVAL.....	85
Drahtsäge, OLIVECRONA.....	332	Elevator, PENNINGTON.....	438	Fasspinzette, DURANTE.....	88
Drahtschere, UNIVERSAL.....	67	Elevator, PIERCE.....	438	Fasspinzette, DUVAL.....	85
Drahtspanninstrument, DEMEL.....	315	Elevator, ROGER.....	437	Fasspinzette, LEROCHE.....	83
Drahtspanninstrument, LOUTE.....	315	Elevator, SAYRE.....	281	Fasspinzette, RUSS. MODELL.....	85
Drahtumföhrungsnadel, DEMEL.....	315	Elevator, SINUS.....	438	Fasszange.....	316
Drahtvalven, Bauchdeckenhalter.....	184	Elevator, WATSON-CHEYNE.....	283	Fasszange, ALLIS.....	537
Drahtzange TC, BERRY.....	319	Elevator, YANKAUER.....	465	Fasszange, ALLIS-ADAIR.....	537
Drahtzange TC, CORWIN-HEGAR.....	319	ELLIOT, Geburtszange.....	603	Fasszange, ALLIS-BABY.....	537
Drahtzange TC, MAYO-HABERISSER.....	319	ELLIS, Fremdkörperhohlmeißel.....	374	Fasszange, BABCOCK.....	539
Dreibackenspannfutter Handgriff.....	300	ELSCHING, Fixationspinzette.....	389	Fasszange, BOYS-ALLIS.....	538
DUBOIS, Schere.....	63	ELSCHING, Hornhautmesser.....	373	Fasszange, COLLIN.....	539, 585
Duftstick.....	231/1	ELSCHING, Kapselpinzette.....	391	Fasszange, DARTIGUES.....	585
DUPLAY, Hakenzange.....	582	ELSCHING, Zykliodialysespatel.....	379	Fasszange, DOYEN.....	585
DUPLAY, Kornzange.....	134	EMMETT, Fistelhäkchen.....	594	Fasszange, DUVAL.....	539
DUPLEX, Stethoskop.....	23	Endarterektomie-Stripper.....	202	Fasszange, GREGOIRE.....	538
DUPUY-WEISS, Tonsillennadel.....	466	Endernagel, STEINMANN.....	307, 308	Fasszange, JUDD-ALLIS.....	538
Dura-Dissektor, DAVIS.....	332	Endoskopiekorb.....	623	Fasszange, KELLY.....	585
Dura-Dissektor, FRAZIER.....	333	Endospekula, KOGAN.....	577	Fasszange, LAHEY.....	479
Dura-Dissektor, HOEN.....	333	ENGEL, Gipszäge.....	229	Fasszange, LANDOLT.....	341/2
Dura-Dissektor, HORSLEY.....	333	Enukleations-Löffel, WELLS.....	378	Fasszange, LITTLEWOOD.....	538
Dura-Dissektor, MILLIGAN.....	332	Episotomie-Schere, BRAUN-STADLER.....	64	Fasszange, LOCKWOOD-ALLIS.....	538
Dura-Dissektor, OLIVECRONA.....	332	Episotomie-Schere, WALDMANN.....	64	Fasszange, LOVELACE.....	490
Dura-Dissektor, PENFIELD.....	333	EPKER, Osteotome.....	464/2	Fasszange, MARTEL.....	110
Dura-Dissektor, SACHS.....	332	EPPENDORFER, Uterus-Biopsiezange.....	590	Fasszange, McGIVNEY.....	568
Dura-Dissektor, TOENNIS.....	332	ERBE, Verbindungskabel.....	633	Fasszange, MILLIN.....	550, 551
Dura-Dissektor, WOODSON.....	333	ERBE/SELECT, Verbindungskabel.....	633	Fasszange, NOTO.....	585
Dura-Haken.....	335	ERICH, Drahtbogen.....	461/2	Fasszange, PRATT.....	110
Dura-Haken, ADSON.....	329	ERRICO, Bohrer.....	299	Fasszange, YOUNG.....	550
Dura-Haken, JACOBSON.....	335	Ersatzklinge.....	49, 50	Fasszange, SERPENTINE-GRASPER.....	593
Dura-Messer, KOOS.....	335	Ersatzlämpchen.....	29, 30	Fasszange, SOMER.....	585
DURANTE, Fasspinzette.....	88	Ersatzsägeblätter.....	230	Fasszange, WILLET-MARTEL.....	110
Dura-Schere, SCHMIEDEN-TAYLOR.....	65/1	Ersatzteilset, HERCULES.....	320/1 - 320/3	Fasszange, WILLIAMS.....	539
DUVAL, Darmfasszange.....	539	ESMARCH, Gipsmesser.....	233	FAULKNER, Kürette.....	449
DUVAL, Fasspinzette.....	85	ESMARCH, Staubinde.....	296	FAURE, Biopsiezange.....	588
Dynamometer, COLLIN.....	25	ESMARCH, Verbandschere.....	69/2	FAURE, Peritoneumklemme.....	123
E		ETHICON, Ciipanlegezange.....	524, 525	FAVALORO, Gefäßschere.....	61
ECHLIN, Hohlmeißelzange.....	240	EVES, Tonsillenschneider.....	468	FEHLAND, Darmklemme.....	542
ECO "C" Diagnostik-Besteck.....	16	EXACTA, Blutdruckmessgerät.....	8	FELCHENFELD, Splitterpinzette.....	91
ECO "T" Diagnostik-Besteck.....	16	Exenterationslöffel, BUNGE.....	378	FELDHEIM, Knochenhalteklammer.....	249
EICKEN (KILLIAN), Spülkanüle.....	433	Extensionsbügel, BOEHLER.....	312	FERGUSSON, Gallensteinlöffel.....	533
Ein- u. Ausschlaginstrumente.....	321	Extensionsbügel, KIRSCHNER.....	312	FERGUSSON, Hämorrhoidalklemme.....	109
Einschläger, BENDER.....	322/1	Extensionsbügel, KIRSCHNER US.....	312	FERGUSSON, Knochenhaltezange.....	243
Elektrode, monopolar.....	629	Extirpationsmeißel, ROLLET.....	374	FERGUSSON, Saugrohr.....	337
Elektrodenball-Koagulation.....	629	Extraktor.....	322/1	FERGUSSON, Schere.....	66
Elektroden-Drahtschlinge.....	629	Extraktionsshaken.....	322	FERGUSSON-FRAZIER, Saugrohr.....	337
Elektroden-Koagulation.....	629	Extraktionsshaken, ARRUGA.....	375	FERRIERA, Wundhaken.....	197
Elektroden-Lanzette.....	629	Extraktionsshaken, I. U. D.....	593	FERRIS-SMITH, Laminektomiezege.....	343
Elektroden-Nadel.....	629	Extraktor, KUENTSCHER.....	322	FERRIS-SMITH, Pinzette.....	85
Elektroden-Schlinge.....	628, 629	Exzentrische Begrenzungsscheibe.....	230/17	FERRIS-SMITH-KERRISON, Bandscheibenstanze.....	344, 344/2
Elevator.....	280	F		Fertigschläger, KUENTSCHER.....	321
Elevator, ALDERDYCE.....	282	Face-Lift-Schere, FREEMAN.....	74	Fiberglas-Lichtträger, KLEINSASSER.....	36
Elevator, BALLENGER.....	439	Face-Lift-Schere, GORNEY.....	73	Filtervlies f. Gipszäge.....	230/18
Elevator, BOIES.....	277	Face-Lift-Schere, KAYE.....	73	Finger-Goniometer.....	25
Elevator, CHANDLER.....	282	Face-Lift-Schere, REES.....	73	Fingerringzäge, HADEO.....	297
Elevator, COTTLE.....	439	Fadengabel, HADEO.....	221	Fingerringzäge, WALTON.....	297
Elevator, COTTLE-JOSEPH.....	439	Fadengabel, Tracheotomie.....	475	Fingersäge, LANGENBECK.....	296
Elevator, CREGO.....	282	Fadenpinzette, McPHERSON.....	392	Fingerschützer, LANGENBECK.....	311
				FINOCHIETTO, Bronchusklemme.....	490

FINOCHIETTO, Nadelhalter.....	211	Fremdkörperkürette, ALVIS	374	Gefässclip, MÜLLER.....	365
FINOCHIETTO, Rippensperrerr.....	482, 484	Fremdkörpernadel.....	374	Gefässclip, YASARGIL.....	345 - 356
FINOCHIETTO-BABY, Rippensperrerr.....	482	Fremdkörpernadel, DAVIS.....	374	Gefässdilator, DeBAKEY.....	529
FINOCHIETTO-BURFORD, Rippensperrerr.....	483	Fremdkörpernadel, FRANCIS.....	374	Gefässdissektor, ROBB.....	530
FINSEN, Wundhaken.....	168	Fremdkörpernadel, LA FORCE.....	374	Gefässklemme, atrauma.....	492, 495/1, 495/2, 523 - 527
FISCH, Dissektor.....	420	Fremdkörpernadel, LEVINSON.....	374	Gefässklemme, BAINBRIDGE.....	495/1, 495/2
FISCH, feines Häkchen.....	335	Fremdkörperzängchen, HARTMANN.....	412	Gefässklemme, BECK.....	520
FISCHER, Irispinzette.....	384	Fremdkörperzängchen, HARTMANN-HOFFMANN.....	412	Gefässklemme, COOLEY.....	510, 518 - 522
FISH, Sonde.....	199	Fremdkörperzängchen, HARTMANN-WULLSTEIN.....	412	Gefässklemme, COOLEY-DERRA.....	519
FISHER, Tonsillennmesser.....	466	Fremdkörperzängchen, STRUEMPEL.....	412	Gefässklemme, DALE.....	494, 495
Fistelhäkchen, EMMETT.....	594	Fremdkörperzange, MATHIEU.....	553/1	Gefässklemme, DARDIK.....	509/1
Fistelsonde, LOCKHART-MUMMERY.....	200	FRENZEL, Nystagmusbrille.....	20	Gefässklemme, DeBAKEY.....	493 - 517
Fistelsonde, PRATT.....	563	FRENZEL, Zungenspatel.....	451	Gefässklemme, DeBAKEY-BAHNSON.....	506
Fixationspinzette, BARRAQUER.....	390	FRIEDMAN, Hohlmeisselzange.....	234	Gefässklemme, DeBAKEY-BECK.....	516
Fixationspinzette, ELSCHNIG.....	389	FRIEDMANN, Speküla.....	577	Gefässklemme, DeBAKEY-MIXTER.....	499/2
Fixationspinzette, GRAEFE.....	389	FRITSCH, Wundhaken.....	163	Gefässklemme, DeBAKEY-MOSQUITO.....	509
Fixationspinzette, GREEN.....	390	FRYKHOLM, Hohlmeisselzange.....	240	Gefässklemme, DeBAKEY-PEAN.....	513
Fixationspinzette, LESTER.....	389	FUCHS, Kapselpinzette.....	391	Gefässklemme, DeBAKEY-RANKIN.....	512
Fixiergabel, BURCH.....	373	FUCHSIG, Arterienklemme.....	113	Gefässklemme, DeBAKEY-RUMEL.....	499
Fixierpinzette, CASTROVIEJO.....	390	Führungshohlsonde, BRUNNER.....	221/1	Gefässklemme, DeBAKEY-SATINSKY.....	502
Fixierpinzette, COTTLE.....	410	Führungshohlsonde, KIRSCHNER.....	221	Gefässklemme, DERRA.....	515
Fixierpinzette, GRAEFE.....	83	Führungshohlsonde, KOENIG.....	221/1	Gefässklemme, DIEFFENBACH.....	104
Fixierpinzette, KIRBY-ARTHUR.....	385	Führungshohlsonde, PAYR.....	221/1	Gefässklemme, DIETRICH.....	510
Fixiervorrichtung, LEYLA.....	368/1	Führungshohlsonde, HADEO.....	221/1	Gefässklemme, GLOVER.....	515
Fixiervorrichtung, ROCHARD.....	186	Führungshohlsonde, SCHMIEDEN.....	221	Gefässklemme, GREGORY.....	517
Flachbohrer, CUSHING.....	299	Führungshohlsonde, SCHMIEDEN-PAYR.....	221	Gefässklemme, HARKEN.....	503
Flachmeissel.....	259, 264, 267	Führungshohlsonde, VIENNA.....	221/1	Gefässklemme, JAVID.....	511
Flachmeissel, ALEXANDER.....	259	Führungsinstrument, DeMARTEL.....	330	Gefässklemme, LAMBERT-KAY.....	505
Flachmeissel, BRÜNNING-LUCAS.....	260	Führungsnadel, REDON.....	207	Gefässklemme, LEES.....	504
Flachmeissel, Ferrozellgriff.....	264	Führungsspiess.....	321	Gefässklemme, LELAND-JONES.....	495
Flachmeissel, HIBBS.....	265			Gefässklemme, MORRIS-DeBAKEY.....	506
Flachmeissel, HOKE.....	265	G		Gefässklemme, POTTS.....	492, 493
Flachmeissel, LEXER.....	263	Galeahaken, YASARGIL.....	330	Gefässklemme, SATINSKY.....	491
Flachmeissel, NOVOTEX-Griff.....	264	GALLAHER, Antrumraspel.....	446	Gefässklemme, SUBRAMANIAN.....	521
Flachmeissel, PARTSCH.....	259	Gallenblasenschere, THOREK.....	65/2	Gefässklemme, WEBER.....	501
Flachmeissel, STILLE.....	260	Gallengangdilator, BAKES.....	532	Gefässklemme, WYLIE.....	501/1, 501/2
Flachzange.....	316, 317	Gallensteinoeffel, DESJARDINS.....	534	Gefässmesser, KOOS.....	335
flexible Fasszange, SERPENTINE-GRASPER.....	593	Gallensteinoeffel, FERGUSON.....	533	Gefässpinzette, ADLERKREUTZ.....	84
flexibler Hirnsattelhalter, LEYLA.....	368/2	Gallensteinoeffel, LUER-KOERTE.....	533	Gefässpinzette, NELSON.....	89
flexibler Spannarm, LEYLA.....	368/3	Gallensteinoeffel, MAYO.....	534	Gefässpinzette, STILLE-BARRAYA.....	88
FOERSTER, Irispinzette.....	383	Gallensteinoeffel, MOOR.....	531	Gefässpinzette, WANGENSTEEN.....	89
FOERSTER, Tupferzange.....	136	Gallensteinsonde, DESJARDINS.....	531	Gefässschere, DeBAKEY.....	61
FOMON, Hauthäkchen.....	447/1	Gallensteinsonde, MAYO.....	534	Gefässschere, DIETRICH.....	60
FOMON, Nasenhaken.....	447/1	Gallensteinsonde, MOYNIHAN.....	531	Gefässschere, FAVALORO.....	61
FOMON, Nasenraspel.....	444, 445	Gallensteinzange, BLAKE.....	530/2	Gefässschere, KELLY.....	61
FOMON, Nasenschere.....	58	Gallensteinzange, DESJARDINS.....	530/2	Gefässschere, KLINKENBERG-LOTH.....	65/2
FOMON, Raspator.....	277	Gallensteinzange, MAYO-BLAKE.....	530/2	Gefässschere, POTTS-DeMARTEL.....	59
FOMON, Rhinoplastschere.....	65/1	Gallensteinzange, MIXTER.....	530/2	Gefässschere, POTTS-SMITH.....	61
FOMON, Septummeissel.....	441	GASS, Häkchen.....	376	Gefässschere, SATINSKY.....	65/2
FOX, Lupuskürette.....	608	GAUSS, Kopfschwarte.....	605	Gefäss-Spülkanüle, SCHMID.....	338
FRAENKEL, Aufsatz.....	472	Geburtsloeffel, SELLHEIM.....	607	GELPI, Bauchdeckenhalter.....	189/1, 189/2
FRAENKEL, Kehlkopfpolypenzange.....	471	Geburtszange.....	602 - 604	GELPI, Haken.....	193
FRANCIS, Fremdkörpernadel.....	374	Geburtszange, BARTON.....	603	GEMINI, Arterienklemme.....	115
FRAZIER, Bauchdeckenhalter.....	181	Geburtszange, BOERMA.....	604	GERALD, Pinzette.....	86, 87
FRAZIER, Dura-Dissektor.....	333	Geburtszange, DeLEE.....	602	GERSTER, Knochenhalteklammer.....	250
FRAZIER, Hauthäkchen.....	148/2	Geburtszange, ELLIOT.....	602	GERZOG, Hammer.....	270
FRAZIER/FERGUSON, Punktionskanüle.....	337	Geburtszange, KIELLAND.....	602	Gewebefasspinzette, BROWN.....	83
FRAZIER/FERGUSON, Saugrohr.....	337	Geburtszange, KIELLAND-LUIKART.....	603	Gewebefasspinzette, SINGLEY.....	88
FREEMAN, Face-Lift-Schere.....	74	Geburtszange, LUIKART.....	603	Gewebefasszange, CHAPUT.....	110
FREEMAN, Wundhaken.....	198	Geburtszange, McLEAN.....	603/1	Gewebefasszange, COLLIN.....	110
FREER, Elevatorium.....	437	Geburtszange, McLEAN-LUIKART.....	603/1	Gewebefasszange, GREGOIRE.....	538
FREER, Hauthäkchen.....	448	Geburtszange, McLEAN-TUCKER.....	603/1	Gewebefasszange, TUFFIER.....	110
FREER, Nasenmesser.....	434	Geburtszange, McLEAN-TUCKER-LUIKART.....	603/1	Gewicht, AUVARD.....	576
FREER, Septumellevator.....	437, 439	Geburtszange, NAEGELE.....	602	Gewicht, SCHERBAK.....	575
FREER, Septumhohlmeissel.....	442/1	Geburtszange, PIPER.....	604	GERTZ-STILLE, Rippenschere.....	481
FREER, Septummeissel.....	439	Geburtszange, SIMPSON.....	602	GIGLI, Säge.....	332
FREER, Septummesser.....	434	Geburtszange, SIMPSON-BRAUN.....	602	GILL, Hornhautmesser.....	373
Fremdkörperfachmeissel, DIX.....	374	Geburtszange, SIMPSON-LUIKART.....	603	GILL, Irispinzette.....	384
Fremdkörperhebel, BUCK.....	412	Geburtszange, TARNIER.....	604	GILL-ARRUGA, Kapselpinzette.....	390
Fremdkörperhebel, QUIRE.....	412	Geburtszange, THIERRY.....	603	GILL-HESS, Irispinzette.....	384
Fremdkörperhohlmeissel, ELLIS.....	374	Geburtszange, WRIGLEY.....	602	GILLIES, Hauthäkchen.....	448
Fremdkörperhohlmeissel, WALTON.....	374	Gefässclip, BIEMER.....	361	GILLIES, Nadelhalter.....	212
Fremdkörperinstrument, DIX.....	380	Gefässclip, MEHDORN.....	362	GILLIES, Pinzette.....	86

GIL-VERNET, Wundhaken	152	GUYON, Nierenklemme	122	Haken, TAYLOR	196
Gipsabreisszange, WOLFF	233	GUYTON-LUNGSGAARD, Sklerotom	373	Haken, TESSIER	463/3
Gipsmesser, ESMARCH	233	Gynäkologie-Schere, DOYEN	63	Hakenzange, ADAIR	582
Gipsmesser, HOPKINS	233	Gynäkologie-Schere, DUBOIS	63	Hakenzange, BARRET	582
Gipsmesser, REINER	233	Gynäkologie-Schere, SIEBOLD	62	Hakenzange, BRAUN	582
Gipsmesser, WIGMORE	229	Gynäkologie-Schere, SIMS	62	Hakenzange, CZERNY	584
Gipssäge, elektrisch	230			Hakenzange, DUPLAY	582
Gipssäge, ENGEL	229	H		Hakenzange, HULKA	583
Gipssäge, oszillierend	230/10, 230/12	HABERER, Darmspatel	143/3	Hakenzange, IOWA	584
Gipsschere, STILLE	229	Hämorrhoidal-Klemme, FERGUSSON	109	Hakenzange, JACOBS	583
Gipsspreizer, BEESON	232	Hämorrhoidal-Ligatur, McGIVNEY	568	Hakenzange, JARCHO	583
Gipsspreizer, HAGLUND-STILLE	232	HAGLUND-STILLE, Gipsspreizer	232	Hakenzange, MUSEUX	583
Gipsspreizer, HENNIG	232	HAIGHT, Rippenspreizer	487	Hakenzange, POZZI-PALMER	582
Gipsspreizer, HADEO	232	HAJEK, Hammer	273	Hakenzange, PRATT	584
GLOVER, Bulldogklemme	103	HAJEK, Septummeißel	442/1	Hakenzange, SCHRÖDER	583, 584
GLOVER, Mehrzweckklemme	515	HAJEK-BALLENGER, Elevator	439	Hakenzange, SCHRÖDER (POZZI)	582
GLUCK, Rippenschere	480	HAJEK-KOFLER, Stanze	429, 431	Hakenzange, SKENE	582
GOELET, Wundhaken	141	Häkchen, ARRUGA	375	Hakenzange, STAUDE-MOORE	582
GOLDMANN-FOX, Zahnfleischschere	96	Häkchen, BARBARA	419	Hakenzange, TEALE	583
GOMMEL, Pinzette	96	Häkchen, BECKER	375	HALLE, scharfer Löffel	253
GOMMEL, Schere	80	Häkchen, BOSE	477	HALLE, Septumelevator	437
Goniometer f. Finger	25	Häkchen, CLAYMAN	376	Halogenlampe	29
Goniotomiemesser, BARKAN	373	Häkchen, CONVERSE	448	HALSEY, Nadelhalter	208
Goniotomiemesser, SCHEIE	373	Häkchen, COTTLE	447/1	HALSTED-MOSQUITO, Arterienklemme	105
GOOD, Tonsillenschere	59	Häkchen, COTTLE-NEIVERT	448	Haltearm, LEYLA	368/1
GOODELL, Uterus-Dilatator	581	Häkchen, DAY	409	Halteklemme, ADSON	298
GORNEY, Dissektor	277	Häkchen, FISCH	335	Halter, Hirnspatel, LEYLA	368/4
GORNEY, Face-Lift-Schere	73	Häkchen, FOMON	447/1	Halter, KALLMORGEN	573
GOSSET, Bauchdeckenhalter	181	Häkchen, FREER	448	Halter, KRISTELLER	572
GOURDET, Uteruslöffel	599	Häkchen, GASS	376	Halterahmen	187
GRADLE, Pinzette	395	Häkchen, GILLIES	448	Haltezange, LANE	325
GRADLE, Schere	57	Häkchen, GRAEFE	375	Hammer	270 - 273
GRAEFE, Cystotom	375	Häkchen, GREEN	375	Hammer, BERGMANN	272
GRAEFE, Disziionsmesser	372	Häkchen, JAMESON	375	Hammer, COLLIN	270
GRAEFE, Fixationspinzette	389	Häkchen, KILNER	447/1, 608	Hammer, COTTLE	273
GRAEFE, Fixierpinzette	83	Häkchen, KNAPP	375	Hammer, Ferrozellgriff	272
GRAEFE, Hauthäkchen	148/2	Häkchen, KRAYENBÜHL	336	Hammer, GERZOG	270
GRAEFE, Irispinzette	382	Häkchen, KUGLEN	376	Hammer, HAJEK	273
GRAEFE, Lidsperrerr	370	Häkchen, LANGE	448	Hammer, HEATH	273
GRAEFE, Schere	56	Häkchen, LUCAE	409	Hammer, KIRK	270
GRAEFE, Schielhaken	375	Häkchen, McGEE	419	Hammer, LUCAE	271
GRAEFE, Startlöffel	377	Häkchen, O'CONNOR	375	Hammer, MEAD	271
GRAEFE, Starmesser	371	Häkchen, ROLLET	375	Hammer, OMBREDANNE	273
GRAHAM, Nervhaken	329	Häkchen, SHAMBAUGH	419	Hammer, PARTSCH	271
GRAIG, Septumzange	426	Häkchen, SINSKEY	376	Hammer, QUISLING	271
GRAVE, Scheidenspekula	570	Häkchen, STEVENS	375	Hammer, WILLIGER	271
GRAY, Arterienklemme	121	Häkchen, Tracheotomie	475	Hämorrhoidal-Ligatur	568
GREEN, Fixationspinzette	390	Häkchen, WAGENER	409	Hämorrhoidal-Ligatur, RUDD	568
GREEN, Hornhautdissektor	374	Häkchen, WIENER	375	Hämorrhoidal-Zange, HEYWOOD-SMITH	567
GREEN, Muskelhäkchen	375	Haken, AUFRICHT	447	Hämorrhoidal-Zange, McGIVNEY	568
GREEN, Wundhaken	160	Haken, BALFOUR	193	Handbohrapparat, BUNELL	299
GREEN-ARMYTAG, Uteruszange	605	Haken, BRAUN	607	Handbohrapparat, HUDSON	299
GREGOIRE, Darm- u. Gewebefasszange	538	Haken, COTTLE	447, 447/1	Handbohrapparat, KIRSCHNER	299
GREGORY, Profundaklemme	517	Haken, GELPI	193	Handbohrapparat, MOORE	298
GREVEN, Ohrzängchen	414	Haken, HARGIS	463/6	Handbohrapparat, RALK	300
Griff, Kehlkopfspiegel	473	Haken, HARRINGTON	193	Handbohrapparat, HADEO	300
Griff, Meißel	266	Haken, HOFER	465	Handbohrapparat, STILLE	298
Griff, Osteotome	266	Haken, ITERSÖN	477	Handgriff	300
Griff, SCHERBAK	575	Haken, JACKSON	476	Handgriff Dreibackenspannfutter	300
Griff, Skalpell	38 - 41	Haken, KELLY	193	Handgriff, NABATOFF	201
Griff, Skalpell Mini	41	Haken, KIRSCHNER	185, 187	Handgriff, Stabinstrumente f. Tracheotomie	475
Griff, Stabinstrumente, Tracheotomie	475	Haken, LOVE	465	Handwaschbürste	611
Griff, Uterus-Biopsiezangen	591	Haken, MASING	447	HANK, Uterus-Dilatator	580
GROSS, Ohrlöffel	409	Haken, MASING-NEIVERT	447	HARGIS, Raspatör	463/2
GROSS-MAIER, Kornzange	134	Haken, NAGER	465	HARGIS, Unterkieferhaken	463, 463/6
GRUBER, Ohrspekula	399	Haken, NEWS	477	HARGIS, Wundhaken	463
GUILLEN, Saugraspatorium	433/1	Haken, OBWEGESER	460, 461/1	HARKEN, Aurikllemme	503
Gummibirne, POLITZER	406	Haken, YOUNG	550	HARMS, Sonde	381
Gummiringe-Ligatur, McGIVNEY	568	Haken, RAMUS	461	HARRINGTON, Bronchusklemme	490
GUTHRIE, Hauthäkchen	148/2	Haken, SCHOENBORN	479	HARRINGTON, Haken	193
GUYON, Arterienklemme	122	Haken, SCOVILLE	196	HARRINGTON, Wundhaken	147
GUYON, Dilatationsbougie	554	Haken, SMELLIE	605	HARRINGTON-PEMBERTON, Wundhaken	147
GUYON, Katheter-Einführungsinstrument	554	Haken, SPINA-NASALIS	461	HARTMANN, Arterienklemme	104

HARTMANN, Fremdkörperzängchen	412	Hochfrequenz-Chirurgie	628, 629	HOUSE, Kürette	420
HARTMANN, Nasenspekula	422	HOEN, Dura-Dissektor	333	HOUSE, Mikro-Messsonde	420
HARTMANN, Nasenzange	427	HOESEL, Nadelhalter	213	HOUSE, Saugrohr	337/2
HARTMANN, Ohrkatheter	408	HOFFER, Wundhaken	465	HOWARTH, Septumelektor	438
HARTMANN, Ohrspekula	399	HOFFMANN, Schlauchklemme	624	HUBER, Universalgriff	472
HARTMANN, Ohrzängchen	411	Hohlmeißel	259, 264	HUDSON, Handbohrapparat	299
HARTMANN, Polypenzange	424	Hohlmeißel, ALEXANDER	259	HUDSON, T-Handgriff	300
HARTMANN, Stimmgabel	403	Hohlmeißel, COBB	262	HULKA, Hakenzange	583
HARTMANN, Zungendrücke	452	Hohlmeißel, HIBBS	265	HUMBLY, Dermatoma	50
HARTMANN-HALLE, Nasenspekula	421	Hohlmeißel, KILLIAN	442/1	HUNTER, Splitterpinzette	91
HARTMANN-HOFFMANN, Fremdkörperzängchen	412	Hohlmeißel, LEXER	263	HURD, Tonsillen-Dissektor	465
HARTMANN-WULLSTEIN, Fremdkörperzängchen	412	Hohlmeißel, LEXER-Mini	263	Hypophysenkürette, RAY	334
HASSON, Wundhaken	143	Hohlmeißel, NOVOTEX	264	Hypophysenpinzette, ADSON	334
HAUGH, Mikro-Ohrzängchen	414	Hohlmeißel, PARTSCH	259	Hypophysenzange	341
Hauthäkchen, COTTLE	447/1	Hohlmeißel, SMITH-PETERSEN	261	Hysterektomieklammer, HEANEY	126
Hauthäkchen, COTTLE-NEIVERT	448	Hohlmeißel, STILLE	260	Hysterektomieklammer, HEANY-BALLENTINE	127
Hauthäkchen, FOMON	447/1	Hohlmeißel, WEST	442/1	Hysterektomieklammer, HOLZBACH	126
Hauthäkchen, FRAZIER	148/2	Hohlmeißel, ZIELKE	264	Hysterektomieklammer, MAINGOT	123/1, 123/2
Hauthäkchen, FREER	448	Hohlmeißelzange, ADSON	236	Hysterektomieklammer, ROGERS	127
Hauthäkchen, GILLIES	448	Hohlmeißelzange, BANE-HARTMANN	237	Hysterektomieklammer, SEGOND	125
Hauthäkchen, GRAEFE	148/2	Hohlmeißelzange, BEYER	237	Hysterektomieklammer, SEGOND-LANDAU	125
Hauthäkchen, GUTHRIE	148/2	Hohlmeißelzange, BLUMENTHAL	236	Hysterektomieklammer, WERTHEIM	124, 128
Hauthäkchen, JOSEPH	149	Hohlmeißelzange, BÖHLER	238	Hysterektomieschere, WERTHEIM	63
Hauthäkchen, KILNER	608	Hohlmeißelzange, CLEVELAND	235		
Hauthäkchen, KLAPP	150	Hohlmeißelzange, ECHLIN	240	I	
Hauthäkchen, KLEINERT-KUTZ	149	Hohlmeißelzange, FRIEDMAN	234	I.U.D., Extraktionshaken	593
Hauthäkchen, LAHEY	149	Hohlmeißelzange, FRIEDMAN-Micro	234	Impaktor	322/1
Hauthäkchen, HADEO	150	Hohlmeißelzange, FRIEDMAN-Mini	234	Insbusschlüssel	230/18
Haut-Trephinen, KEYE	608	Hohlmeißelzange, FRYKHOLM	240	INGE, Wirbelkörperspreizer	339
HAYES, Darmklemme	545	Hohlmeißelzange, JANSEN	237	INGROWN, Nagelinstrument	612/1
HAYES, Rektum-Anastosenklemme	545	Hohlmeißelzange, KLEINERT-KUTZ	237	Injektionskanüle	36
HEANEY, Hysterektomieklammer	126	Hohlmeißelzange, LEKSELL (STILLE)	240	INSTRU-CARE, Instrumentenöl	635
HEANEY, Nadelhalter	210	Hohlmeißelzange, LEMPERT	237	Instrumente f. Tracheotomie	475
HEANY, Biopsiekürette	587	Hohlmeißelzange, LUER	236	Instrumentenkasten	617
HEANY, Wundhaken	164	Hohlmeißelzange, MARQUARDT	239	Instrumentenöl, INSTRU-CARE	635
HEANY-BALLENTINE, Hysterektomieklammer	127	Hohlmeißelzange, MAYFIELD	238	Insufflationskanüle, VERESS	206
HEATH, Fadenschere	66	Hohlmeißelzange, MEAD	235	Intraorale Retraktoren	463/1, 463/4
HEATH, Hammer	273	Hohlmeißelzange, OLIVECRONA	237	Inzisionschere	52
HEBRA, Chalzazionskürette	377	Hohlmeißelzange, RUSKIN	239	IOWA, Hakenzange	584
HEGAR, Uterus-Dilatator	578, 579	Hohlmeißelzange, SAUERBRUCH	240	IOWA, Nadelführer	206
HEGENBARTH, Wundklammerpinzette	224	Hohlmeißelzange, SCAGLIETTI	240	IRIS, Schere	54/2
HEIFETZ, Hirnspatel	369	Hohlmeißelzange, SEMB	240	Irisschere, KNAPP	55
HEIMING, Nierensteinzange	536	Hohlmeißelzange, SMITH-PETERSEN	238	Irisschere, LITTLER	55
HEISS, Arterienklemme	112	Hohlmeißelzange, STELLBRINK	234	IRIS, Supercutschere	72
HEISTER, Mundsperrer	454	Hohlmeißelzange, STILLE-LUER	239	Irishäkchen, O'CONNOR	375
Hemilaminektomiespreizer, DARLING	178	Hohlmeißelzange, STILLE-RUSKIN	239	Irishäkchen, WIENER	375
HENKE, Tonsillenelevator	465	Hohlmeißelzange, ZAUFAL-JANSEN	238	Irismesser, DEAN	372
HENLEY, Wundspreizer	170	Hohlsonde	199	Irismesser, KNAPP	372
HENNIG, Gipsspreizer	232	Hohlsonde, BRODIE	199	Irismesser, ZIEGLER	372
HEPA-Filter	231/1	Hohlsonde, DOYEN	199	Irispinzette, BARRAQUER	384
HEPP-SCHUIDEL, Schere	78	Hohlsonde, NELATON	199	Irispinzette, BARRAQUER-KATZIN	384
HERCULES, Drahtkniefzange	320/1 - 320/3	HOHMANN, Knochenheber	284, 285	Irispinzette, BISHOP-HARMAN	386
HERRICK, Nierenstielklemme	123	HOHMANN-Mini, Knochenheber	286	Irispinzette, BONN	387
HESS, Irispinzette	384	HOKE, Flachmeißel	265	Irispinzette, FISCHER	384
HESS, Kapselpinzette	391	HOKE, Osteotome	265	Irispinzette, FOERSTER	383
HESS, Nervwurzelhaken	329/1	HOLINGER, OP-Laryngoskop	37	Irispinzette, GILL	384
HEYMANN, Nasenschere	58	HOLLINGER, Lichtträger	37	Irispinzette, GILL-HESS	384
HEYMANN, Septumzange	425	HOLSHER, Nervwurzelhaken	329/1	Irispinzette, GRAEFE	382
HEYMANN-KNIGHT, Polypenzange	425	HOLTH, Kapselstanze	380	Irispinzette, HESS	384
HEYWOOD-SMITH, Hämorrhoidalzange	567	HOLZBACH, Hysterektomieklammer	126	Irispinzette, STEVENS	383
HIBBS, Flachmeißel	265	HOLZHEIMER, Wundhaken	168	Irispinzette, TROUTMAN	384
HIBBS, Hohlmeißel	265	HOPKINS, Gipsmesser	233	Irispsattel, WECKER	378
HIBBS, Osteotome	265	HORGAN, Valve Bauchdeckenhalter	183	ISRAEL, Wundhaken	162
HIBBS, Wundhaken	164	HORIZON, Clipanlagezange	524, 525	ITERSON, Trachealhaken	477
HILL-FERGUSON, Rektal-Spekulum	560	Hornhautdissektor, GREEN	374, 375	IVES-FANSLER, Anuskop	562
Hirnmesser	48	Hornhautdissektor, PATON	373	IWANSON, Messgerät	624
Hirnspatel, CUSHING	336, 369	Hornhautmesser, ELSCHNIG	373		
Hirnspatel, DAVIS	337	Hornhautmesser, GILL	373	J	
Hirnspatel, HEIFETZ	369	Hornhautmesser, SATO	373	JACKSON-BURROWS, Bauchdeckenhalter	189/2
Hirnspatel, OLIVECRONA	336	Hornhautmesser, TOOK	373	JACKSON, Kehlkopfpinzette	471
Hirnspatelhalter, LEYLA	368/2	Hornhautschere, CASTROVIEJO	79	JACKSON, Laryngoskop	37
HIRSCHMANN, Anuskop	562	HORSLEY, Dura-Dissektor	333	JACKSON, Pinzette	471
HIRSCHMANN, Zykliodialsympatel	379	HÖSEL, Wundhaken	167	JACKSON, Scheidenspekula	573

JACKSON, Sehnenfasszange	292	Kapselpinzette, CASTROVIEJO	391	KIRK, Hammer	270
JACKSON, Trachelhaken	476	Kapselpinzette, ELSCHNIG	391	KIRSCHNER, Bauchdeckenhalter	185, 187, 187/1
JACOBS, Hakenzange	583	Kapselpinzette, FUCHS	391	KIRSCHNER, Bohrdraht	306, 307
JACOBSON, Arterienklemme	105	Kapselpinzette, GILL-ARRUGA	390	KIRSCHNER, Extensionsbügel	312
JACOBSON, Dura-Haken	335	Kapselpinzette, HESS	391	KIRSCHNER, Führungshohlsonde	221
JACOBSON, Knopfsonde	335	Kapselpinzette, KALT	391	KIRSCHNER, Haken	185, 187
JACOBSON, Nadelhalter	215	Kapselpinzette, SCHWEIGGER	391	KIRSCHNER, Handbohrapparat	299
JACOBSON, scharfer Löffel	257	Kapselpinzette, TERSON	391	KIRSCHNER, Zughaken	313
JAEGER, Lanzenmesser	372	Kapselschere, RESANO	53/2	KIRSCHNER US, Extensionsbügel	312
JAEGER, Lidplatte	371	Kapselstanze, HOLTH	380	Klammeranlegezange, RANEY	327
JAMESON, Schielhaken	375	Katheter, COXETER	555	Klammerhalter	326
JAMESON, Strabismuspinzette	385	Katheter, Metall	555	KLAPP, Wundhaken	150
JANSEN, Hohlmeisselzange	237	Katheter, WALTHER	555	KLEINERT-KUTZ, Hauthäkchen	149
JANSEN, Nasenpinzette	424	Kathetereinführungsinstrument, GUYON	554	KLEINERT-KUTZ, Hohlmeissel	237
JANSEN, scharfer Löffel	257	Kathetereinführungzange, MAGILL	28	KLEINERT-KUTZ, Sehnerfassinstrument	294
JANSEN, Wundhaken	168	Katheterklemme, COOLEY	510	KLEINSASSER, Bruststütze	36
JANSEN-GRUENWALD, Nasenpinzette	424	KAYE, Face-Lift-Schere	73	KLEINSASSER, Fiberglas-Lichtträger	36
JARCHO, Hakenzange	583	Kegel, SCHULTZE Salpingograph	596	KLEINSASSER, Injektionskanüle	36
JAVID, Carotis-Shuntklemme	511	Kehldeckelhalter, REICHERT	471	KLEINSASSER, Rauchabsaugrohr	36
JENNINGS, Mundsperrer	454	Kehlkopfkanüle	470	KLEINSCHMIDT, Blinddarmklemme	544
JENSEN, Augenkanüle	394	Kehlkopfpinzette, JACKSON	471	Klemme, ALLEN	544
JOBSON-HORNE, Watteträger	203	Kehlkopfpolypenzange, FRAENKEL	471	Klemme, HAYES	545
JOHNS-HOPKINS, Anlegezange	104	Kehlkopfpolypenzange, JURASZ	471	Klemme, HOFFMANN	624
JOHNS-HOPKINS, Arterienklemme	120	Kehlkopfschere, KILLIAN	471	Klemme, KLEINSCHMIDT	544
JOHNS-HOPKINS, Bulldogklemme	104	Kehlkopfspiegel	473	Klemme, LANE	547
JOHNSON, Nadelhalter	211	Kehlkopfspiegel-Griff	473	Klemme, PAYR	548
JONES, Tuchklemme	132	Kehlkopfspiegel, MICHEL	423	Klemme, STOCKMANN	553/1
JONES-CLIP, Tuchklemme	132	Kehlkopfspritze	470	Klemme, STONE-WATT	545
JORGENSEN, Präparierschere	53	KEINSASSER, OP-Laryngoskop	35	Klemme, STRAUSS	553/1
JOSEF, Nasenmesser	434, 435	KEITH, Nadel	223	Klemme, Vasektomie	553/2
JOSEPH (LEWIS), Nasenraspel	443	KELLY, Anuskop	562, 563	Klemmenhalterung, DeMARTEL-WOLFSON	546
JOSEPH, Hauthäkchen	149	KELLY, Arterienklemme	106	Klemmenschießzange, DeMARTEL-WOLFSON	546
JOSEPH, Nasenmesser	434	KELLY, Gefäßschere	61	Klemmschloss, STONE-WATT	545
JOSEPH, Nasenraspel	443	KELLY, Proktoskop	563, 564	Klemmsockel	189
JOSEPH, Nasensäge	446	KELLY, Uterus-Polypenzange	585	Klinge	49
JOSEPH, Raspator	277	KELLY, Wundhaken	164, 193	Klinge-Skalpell	42
JOSEPH, Schere	54/1	KELLY-GRIP, Wundhaken	142	Klingenbrecher, CASTROVIEJO	45
JOSEPH, Septumelelevator	437	KELLY-RANKIN, Arterienklemme	106	Klingenbrecher, HADEO	45
JUDD-ALLIS, Darmfasszange	538	Keratoplastik-Messer, BARRAQUER	373	Klingenbrecher, TROUTMAN-CHRIS	45
JUDD-MASSON, Blasenwundspreizer	552	Keratoplastik-Messer PAUFIQUE	373	Klingenentferner	42
JUERS, Mikro-Ohrzängchen	414	KERN, Knochenhalte zange	244	KLINIKUM BERLIN, Schlauchklemme	129
JURASZ, Kehlkopfpolypenzange	471	KERRISON, Stanze	428	KLINIKENBERG-LOTH, Gefäßschere	65/2
K		KEVORKIAN, Biopsiekürette	587	KNAPP, Irismesser	372
Kabel, bipolar	633	KEVORKIAN, Uterus-Biopsiezange	589, 591	KNAPP, Irisschere	55
KABIERESKE, Pulverbläser	405	KEVORKIAN-PACIFIC, Uterus-Biopsiezange	592	KNAPP, Starlöffel	378
KADER, Bauch- u. Darmspatel	143/3	KEY, Elevator	282	KNAPP, Tränensackhäkchen	375
KALLMORGEN, Halter	573	KEYES, Trephe	608	KNAPP-LUER, Trachompinzette	393
KALLMORGEN, Scheidenspekula	573	Kieferhöhlenstanze, HAJEK-KOFLER	429, 431	KNIGHT, Septumzange	425
KALT, Kapselpinzette	391	Kieferhöhlenstanze, KERRISON	428	Knochendraht	314
KALT, Nadelhalter	214	Kieferhöhlentroker, COAKLEY	204	Knochenfeile	294, 612/1
KALT-ARRUGA, Nadelhalter	214	Kieferhöhlentroker, DOUGLAS	204	Knochenhaken, VOLKMANN	156
Kaltlichtklammer	601	Kieferhöhlentroker, LICHTWITZ	204	Knochenhakenklammer, GERSTER	250
Kaltlichtträger, HOLLINGER	37	Kieferhöhlentroker, PIERCE	204	Knochenhakenklammer, LAMBERT-LOWMAN	249
Kaltlichtträger, JACKSON	37	KIELLAND, Geburtszange	602	Knochenhakenklammer, LOWMAN	249
KANE, Nabelschnurklemme	605	KIELLAND-LUIKART, Geburtszange	603	Knochenhakenklammer, LOWMAN-HOGLUND	249
KANTROWITZ, Arterienklemme	119/1	KILLIAN, Hohlmeissel	442/1	Knochenhalte zange	245, 247, 249
Kanüle, Air Injection	394	KILLIAN, Nasenspekula	423	Knochenhalte zange, BIRCHER-GANSKE	246
Kanüle, BISHOP-HARMON	394/1	KILLIAN, Septumelelevator	438, 439	Knochenhalte zange, DINGMANN	246
Kanüle, EICKEN (KILLIAN)	433	KILLIAN, Septumschere	471	Knochenhalte zange, FARABEUF	243
Kanüle, JENSEN	394	KILLIAN, Spülkanüle	433, 433/1	Knochenhalte zange, FARABEUF-LAMBOTTE	243
Kanüle, KILLIAN	433/1	KILLIAN-CLAUS, Septumhohlmeissel	442/1	Knochenhalte zange, FERGUSSON	243
Kanüle, LACRIMAL	394	KILNER, Hauthäkchen	608	Knochenhalte zange, KERF	244
Kanüle, McIntyre	394	KILNER, Nadelhalter	212	Knochenhalte zange, LAMBOTTE	244
Kanüle, ROSEN	338	KILNER, Nasenhaken	447/1	Knochenhalte zange, LANE	244
Kanüle, Saugriff, ZÖLLNER u. WULLSTEIN	337/1	KILNER, Schere	54/1	Knochenhalte zange, LANGENBECK	243
Kanüle, SCHMID	338	KILNER, Supercuttschere	72	Knochenhalte zange, LEWIN	246
Kanüle, SIMCOE	394/2	KILNER-DOUGHTY, Mundsperrer	456	Knochenhalte zange, MARTIN	246
Kanüle, VERRÉS	206	Kinder-Aortaklemme, SUBRAMANIAN	521	Knochenhalte zange, MEYER	248
Kanüle, WAGENER-MOSHER	477	Kinder-Aortaklemme, SUBRAMANIAN-MINATURE	521	Knochenhalte zange, PATELLA	248
Kappenzange, HADEO	615	Kinder-Atrauma-Gefäßklemme	526, 527	Knochenhalte zange, HADEO	246, 247
Kapsel fasszange, MILLIN	550, 551	Kinder-Gefäßklemme	527	Knochenhalte zange, REILL	248
Kapselpinzette, ARRUGA	391	Kinder-Gefäßklemme, COOLEY	522	Knochenhalte zange, SEMB	243
		KIRBY-ARTHUR, Fixierpinzette	385	Knochenhalte zange, ULRICH	248

Knochenhaltezange, VAN BUREN	249	Kornzange, ULRICH	135	Laminektomie-Zange, DECKER	341
Knochenhaltezange, VERBRUGGE	245	KÖRTE, Bauch- u. Darmspatel	143/3	Laminektomie-Zange, FERRIS-SMITH	343
Knochenhebel	282 - 286/2, 288	Krampfaderbesteck, NABATOFF	201	Laminektomie-Zange, LANDOLT	341/2
Knochenhebel, AUFRANC-COBRA	289	Kranioclast, BRAUN	607	Laminektomie-Zange, LOVE-GRUENWALD	340
Knochenhebel, BENNETT	283	Kranioclast, TARNIER	607	Laminektomie-Zange, OLDBERG	341/1
Knochenhebel, BLOUNT	288	KRAUSE, Aufsatz	472	Laminektomie-Zange, PEAPOD	341/1
Knochenhebel, BRISTOW	290	KRAUSE, Polypenschnürer	411, 433/2	Laminektomie-Zange, SCHLESINGER	342
Knochenhebel, BUCK-GRAMCKO	285	KRAUSE-VOSS, Polypenschnürer	433/2	Laminektomie-Zange, SPURLING	340
Knochenhebel, HOHMANN	284, 285	KRAYENBÜHL, Nervhäkchen	336	Laminektomie-Zange, WAGNER	343
Knochenhebel, HOHMANN Mini	286	Kreuzschlitzschraubenzieher, LANE	324	Laminektomie-Zange, WIDMANN	371
Knochenhebel, KÖNIG	284	KRISTELLER, Halter	572	LANDAU, Scheidenspekula	577
Knochenhebel, LANE	290	KRISTELLER, Scheidenspekula	572	LANDOLT, Enukleationsschere	58
Knochenhebel, LANGE-HOHMANN	286	KROENIG, Zungenspatel	451	LANDOLT, Laminektomiezange	341/2
Knochenhebel, LANE-TRETHOWAN	290	KRONECKER, Unterbindungsnadel	219	LANDOLT, Tumorfasszange	341
Knochenhebel, MURPHY-LANE	283	Kronenschere, BEEBEE	68	LANE, Biegehebel	325
Knochenhebel, SMILLIE	291	Kropffasszange, LAHEY	479	LANE, Knochenhaltezange	244
Knochenhebel, TAYLOR	291	Kropfsonde, KOCHER	479	LANE, Knochenhebel	290
Knochenhebel, VERBRUGGE-MÜLLER	287	Kugelenkklöben, LEYLA	368/1	LANE, Knochenplatten-Haltezange	325
Knochnagel	309	KÜGLEN, Häkchen	376	LANE, Kreuzschlitz-Schraubenzieher	324
Knochnagel, STEINMANN	307, 308	KÜMMEL, Bauch- u. Darmspatel	143/2	LANE, Magenquetschklemme	547
Knochenplattenhalte-zange, LANE	325	KÜNTSCHER, Aufreiber	321	LANE, Pinzette	84
Knochenraspel	294	KÜNTSCHER, Extraktor	322	LANE, Schraubenhalte-zange	325
Knochenraspel, PUTTI	294	KÜNTSCHER, Fertigschläger	321	LANE, Schraubenzieher	323
Knochen-splitterzange, BÖHLER	241	KÜNTSCHER, Vorböhrer	321	LANE, Tuchklemme	133
Knochen-splitterzange, COTTLE-KAZANJIAN	241	Kupplungskopf, LEYLA	368/1	LANE-TRETHOWAN, Knochenhebel	290
Knochen-splitterzange, LISTON	241	Kürette	600, 612	LANG, Tränensack-Dissektor	378
Knochen-splitterzange, McINDOE	241	Kürette, ANTRUM	435	LANGE, Aufsatz	472
Knochen-splitterzange, RUSKIN-LISTON	241	Kürette, BLAKE	595	LANGE, Nasenflügelhäkchen	448
Knochen-splitterzange, SEMB	242	Kürette, BUMM	597	LANGE-HOHMANN, Knochenhebel	286
Knochen-splitterzange, STAMM	241	Kürette, COAKLEY	449	LANGENBECK, Amputationsmesser	44
Knochen-splitterzange, STILLE-HORSLEY	242	Kürette, COBB	252	LANGENBECK, Fingersäge	296
Knochen-splitterzange, STILLE-LISTON	242	Kürette, FAULKNER	449	LANGENBECK, Fingerschützer	311
Knochenstanze, CITELLI	430	Kürette, FOX	608	LANGENBECK, Knochenhalte-zange	243
Knochenstanze, OSTROEM	430	Kürette, GOURDET	599	LANGENBECK, Knorpelmesser	47
Knopfsonde	199	Kürette, HEANY	584	LANGENBECK, Nadelhalter	213
Knopfsonde, JACOBSON	335	Kürette, HEBRA	377	LANGENBECK, Ohrschlinge	409
Knorpelmesser, LANGENBECK	47	Kürette, HOUSE	420	LANGENBECK, Raspator	275
Knorpelquetscher, COTTLE	440	Kürette, KEVORKIAN	587	LANGENBECK, Wundhaken	158, 159
Knorpelschere, McINDOE	65/1	Kürette, MEYHOEFER	377	LANGENBECK-GREEN, Wundhaken	153
KNOWLES, Verbandschere	70	Kürette, MOD. MUENCHEN	587	Langenmesser, JAEGER	372
Koagulationselektrode	629	Kürette, NOVAK	587	Lärmtrommel, BARANY	405
KOCHER, Arterienklemme	108	Kürette, PIFFARD	608	LARSEN, Sehnenfasspinzette	292
KOCHER, Blasenspatel	552	Kürette, RANDALL	587	Laryngoskop, HOLINGER	37
KOCHER, Darmklemme	540	Kürette, RAY	334	Laryngoskop, JACKSON	37
KOCHER, Kropfsonde	479	Kürette, RECAMIER	597	Laryngoskop, MILLER	30
KOCHER, Wundhaken	155, 159, 160, 163	Kürette, SCHRÖDER	595	Laryngoskop-Kaltlichtgriff, Batteriegriff	33
KOCHER-LANGENBECK, Wundhaken	159	Kürette, SIMS	597	Laryngoskop-Warmlicht, Batteriegriff	32
KOENIG, Führungshohlsonde	221/1	Kürette, THOMAS	599	Laryngoskop-Warmlichtgriff, Trafo-Anschluss	34
KOENIG, Nadel	223			Lateralspreizer	569
KOERTE, Wundhaken	162	L		LAWRENCE, Arterienklemme	119
Koffer, Gipssäge	230/18	LA FORCE, Fremdkörperradel	374	LEBSCHKE, Sternummeißel	267
KOGAN, Endoskopkula	577	LA FORCE, Ringmesser	450	LEES, Bronchusklemme	504
Komedonenquetscher, SAALFELD	608	LA GRANGE, Zahnfleissschere	69	LEGUE, Blasenwundspreizer	553
Komedonenquetscher, SCHAMBERG	608	LA GRANGE, Supercutschere	72	LEGUEU, Blasenspatel	552
Komedonenquetscher, UNNA	608	LABORDE, Trachealdilatator	476	LEKSELL (STILLE), Hohlmeißelzange	240
Komedonenquetscher, WALTON	608	LACHRIMAL, Augenkantüle	394	LELAND-JONES, Gefäßklemme	495
Kompressorium, FELDHEIM	249	Ladekonus, RUDD	568	LEMPERT, Elevator	420
Komprimeter	295	LAHEY, Arterienklemme	120	LEMPERT, Hohlmeißelzange	237
KÖNIG, Knochenhebel	284	LAHEY, Kropffasszange	479	LEMPERT, scharfer Löffel	256
KÖNIG, Raspator	276	LAHEY, Wundhaken	157	LERICHE, Fasspinzette	83
KÖNIG, Wundhaken	153	LAMBERT, Chalazionspinzette	393	LERICHE, Arterienklemme	111
KOOS, Duramesser	335	LAMBERT-KAY, Anastomosenklemme	505	LERICHE, Bauchspatel	143/2
Kopfnautklammer, RANEY	327	LAMBERT-LOWMAN, Knochenhalteklammer	249	LERICHE, Darmspatel	143/2
Kopfschwartzange, GAUSS	605	LAMBOTTE, Knochenhalte-zange	244	LERICHE, Fixationspinzette	389
Kornzange	135	LAMBOTTE, Osteotom	261	LEVINSON, Fremdkörperradel	374
Kornzange, BRYANT	137	LAMBOTTE, Raspator	274	LEWIN, Knochenhalte-zange	246
Kornzange, CHERON	137	Laminektomie-Spreizer, CHERRY	488	LEWIS, Nasenraspel	443
Kornzange, COLLIN	137	Laminektomie-Spreizer, CASPAR	179, 180	LEXER-BABY, Präparierschere	53
Kornzange, DUPLAY	134	Laminektomie-Spreizer, MEYERDING	180	LEXER, Flachmeißel	263
Kornzange, GROSS-MAIER	134	Laminektomie-Spreizer, SCOVILLE	196	LEXER, Hohlmeißel	263
Kornzange, MAIER	134	Laminektomie-Spreizer, SCOVILLE-HAVERFIELD	196	LEXER-Mini, Hohlmeißel	263
Kornzange, PELKMANN	137	Laminektomie-Zange, CLOWARD	342	LEXER, Präparierschere	53
Kornzange, SIMS-MAIER	134	Laminektomie-Zange, CUSHING	340	LEYLA, Fixiervorrichtung	368/1

LEYLA, Haltearm	368/4	LUCAE, Hähchen	409	MAXI-GRASPER, Uterus-Biopsiezange	593
LEYLA, Himpfhalter	368	LUCAE, Hammer	271	MAY, Ophthalmoskop UNI II	14
LEYLA, Kugelgelenkkloben	368/4	LUCAE, Ohrpinzette	410	MAYFIELD, Hohlmeißelzange	238
LEYLA, Kupplungskopf	368/4	LUCAE, Parazentese-Nadel	408	MAYO, Gallensteinlöffel	534
LEYLA, Retraktor-System	368 - 368/4	LUCAE, Stimmgabel	404	MAYO, Gallensteinsonde	534
LICHTENBERG, Nadelhalter	213	LUER, Hohlmeißelzange	236	MAYO, Pinzette	89
Lichtleiterkabel-Siebkorb	623	LUER, Trachealkanüle	479	MAYO, Präparierschere	52/1
Lichtträger	37	LUER, Wundhaken	140	MAYO, Sterilsierklammer	227, 624
Lichtträger, JACKSON	37	LUER-KOERTE, Gallensteinlöffel	533	MAYO, Supercutschere	71
Lichtträger, HOLLINGER	37	Luftdusche, POLITZER	406	MAYO, Zungenspatel	451
LICHTWITZ, Kieferhöhlentroker	204	Luftpumpe	295	MAYO-ADAMS, Wundspreizer	171
Lidplatte, JAEGER	371	LUKART, Geburtszange	603	MAYO-BLAKE, Gallensteinzange	530/2
Lidsperre, ARRUGA	370	LUKART-BILL, Zughebel	604	MAYO-COLLINS, Wundhaken	141
Lidsperre, BARRAQUER	370	Lungenfasszange, LOVELACE	490	MAYO-GUYON, Arterienklemme	122
Lidsperre, BOWMAN	370	Lungenschere, CRAFOORD	65/2	MAYO-HABERISSER, Drahtzange	319
Lidsperre, CASTROVIEJO	371	Lungenspatel	489/2	MAYO-HEGAR, Nadelhalter	209
Lidsperre, CLARK	370	Lungenspatel, ALLISON	489/2	MAYO-NOBLE, Präparierschere	52/1
Lidsperre, CRITCHETT	370	LUNGSGAARD, Sklierotom	373	MAYO-ROBSON, Darmklemme	541
Lidsperre, GRAEFE	370	LUINIATSCHEK, Tamponstopfer	465	MAYO-STILLE, Präparierschere	52/1
Lidsperre, LANCASTER	371	Lupuskürlette, FOX	608	MAYO-STILLE, Supercutschere	71
Lidsperre, LIEBERMAN	371	Lupuskürlette, PIFFARD	608	McDONALD, Elevator	283
Lidsperre, LISTER-BURCH	370	M		McCULLOUGH, Strabismuspinzette	385
Lidsperre, MELLINGER	370	Magen-Darmnähapparat, PETZ	549	McGEE, Hähchen	419
Lidsperre, MELLINGER-AXENFELD	370	Magen-Darmklemme, LANE	547	McGEE, Mikro-Ohrzangchen	414
Lidsperre, MUELLER	371	Magen-Darmklemme, MIKULICZ	547	McGIVNEY, Hämorrhoidal-Ligator	568
Lidsperre, MURDOCK	370	Magen-Darmklemme, PAYR	548	McGIVNEY, Hämorrhoidal-Zange	568
Lidsperre, PARK	371	MAGEN-Darmklemme, SMITH	370	McINDOE, Knochensplitterzange	241
Lidsperre, SMITH	370	MAGILL, Kathetereinführzange	134	McINDOE, Knorpelschere	65/1
Lidsperre, STEVENSON	371	MAIER, Kornzange	134	McINDOE, Pinzette	85
Lidsperre, WEEK	370	MAINGOT, Hysterektomieklammer	123/1, 123/2	McINTYRE, Augenkanüle	394
Lidsperre, WILLIAMS	370	MALTZ (COTTLE), Nasenraspel	444	McIVOR, Mundsperrerr	457
Lidsperre, ZIEGLER	371	MALTZ, Nasenraspel	443	McKENY, Septumlevator	437, 338
LIEBERMAN, Lidsperre	371	Mammaria, Sternum-Sperrerr	487/1	McKENZIE, Anlegezange	426
Ligatur-Gummiringe, McGIVNEY	568	Mandrin, RUMEL-BELMONT	528	McKENZIE, Bohrer	299
Ligaturklemme, DeBAKEY	499, 500	Manometer	295	McLEAN, Geburtszange	603/1
Ligaturklemme, DeBAKEY-RUMEL	499	Manometer, SCHULTZE	596	McLEAN-LUIKART, Geburtszange	603/1
Ligaturschere	54	Markierungsinstrument, CONNIN-AMSLER	380	McLEAN-TUCKER, Geburtszange	603/1
Linsenhaken, STEVENS	375	Markraumböhrer	322	McLEAN-TUCKER-LUIKART, Geburtszange	603/1
Linsenmanipulator, BECHERT	379	MARQUARD, Hohlmeißelzange	239	McPHERSON, Fadenpinzette	392
Lippenhalter	453, 451	MARSCHIK, Tonsillenfasspinzette	468	MEAD, Hammer	271
Lippenhalter, CAWOOD-MINNESOTA	451	MARTEL, Fasszange	110	MEAD, Hohlmeißelzange	235
LISTER (SINUS) Tupferzange	137	MARTIN, Beckenzirkel	605	Medizinbecher	621
LISTER, Supercutschere	72	MARTIN, Cartilageschere	65/1	Medizinlöffel	268, 621
LISTER, Verbandschere	69/1	MARTIN, Knochenhaltezange	246	MEEKER, Arterienklemme	119
LISTER-BURCH, Lidsperre	370	MARTIN, Uterussonde	586	MEHDORN, Anlegepinzette	362
LISTON, Amputationsmesser	44	MARTIN, Verbindungskabel	633	MEHDORN, Gefäßsclipp	362
LISTON, Knochensplitterzange	241	MARTIN, Wundspreizer	175/1	Mehrzweck-Gefäßklemme	520
LITTAUER, Cilienpinzette	395	MARTINI, scharfer Löffel	257	Mehrzweck-Gefäßklemme, BAINBRIDGE	495/1, 495/2
LITTAUER, Fadenschere	66	MASING, Elevator	437	Mehrzweck-Gefäßklemme, COOLEY	518 - 520
LITTAUER, Ohrzangchen	411	MASING, Nasenhaken	447	Mehrzweck-Gefäßklemme, GLOVER	515
LITTAUER, Polypenzange	425	MASSING-NEIVERT, Nasenhaken	447	Mehrzweck-Gefäßklemme, DeBAKEY	495, 508, 514 - 517
LITTLE, Wundhaken	157	MASSON, Nadelhalter	210	Mehrzweckschale	620
LITTLE, Irisschere	55	Maßband	25	Meissel, BRUNETTI	268
LITTLEWOOD, Darmfasszange	538	Maßstab, Metall	25	Meissel, CINELLI	441
LOCKHART-MUMMERY, Fistelzange	200	Mastdarm-Biopsiezange, TURREL	567	Meissel, FREER	442/1
LOCKLIN, Zahnfleischschere	69	Mastdarm-Biopsiezange, YEOMAN	566, 567	Meissel, HAJEK	442/1
LOCKWOOD-ALLIS, Darmfasszange	538	Mastdarm-Spekula, ALAN-PARKS	561	Meissel, KILLIAN	442/1
Löffelzangchen	416	Mastdarm-Spekula, BARR	559	Meissel, KILLIAN-CLAUS	442/1
LONDON-COLLEGE, Zahnpinzette	93	Mastdarm-Spekula, BODENHAMMER	559	Meissel, SILVER	442
LOPEZ-REINKE, Tonsillen-Dissektor	465	Mastdarm-Spekula, CZERNY	559	Meissel, WEST	442/1
LORENZ, Verbandschere	70	Mastdarm-Spekula, MATHIEU	560	Meisselklinge	266
LORNA, Tuchklemme	133	Mastdarm-Spekula, PRATT	559	MELLINGER, Lidsperre	370
LOUTE, Drahtspanninstrument	315	Mastdarm-Spekula, SIMS	559	MELLINGER-AXENFELD, Lidsperre	370
LOVE, Nervwurzelhaken	329/2, 330	Mastdarm-Spekula, SCHULZE-BERGMANN	560	MENGHINI, Biopsiekannüle	206
LOVE, Wundhaken	465	MASTIN, Muskelklemme	479	Meniskusshaken, BLOUNT	289
LOVE-GRUENWALD, Laminektomiezange	340	MATHIEU, Fremdkörperzange	553/1	Meniskusmesser, NEFF	292
LOVELACE, Arterienklemme	109	MATHIEU, Mastdarmspekula	560	Meniskusmesser, SMILLIE	292
LOVELACE, Lungenfasszange	490	MATHIEU, Nadelhalter	213	MERCEDES, Thoraxsperrerr	489
LOWER, Arterienklemme	120	MATHIEU, Wundhaken	141	MERIAM, Zahnpinzette	93
LOWMAN, Knochenhalteklammer	249	MATHIEU-OLSEN, Nadelhalter	212	Messbecher	620
LOWMAN-HOGLUND, Knochenhalteklammer	249	MATSON, Raspator	279	Messer, Amputation	44
LUBET-BARBON, Nasentamponzange	424	MATSON-ALEXANDER, Raspator	279	Messer, BARKAN	373
LUC, Septumzange	426	MAUNDER, Mundkeil	459	Messer, BARRAQUER	373

Messer, BERENS.....	372	MILLIN, Blasenperrerr.....	552, 553	N	
Messer, CASTROVIEJO.....	372	MILLIN, Kapselasspinnzette.....	550, 551	NABATOFF, Krampfaderbesteck.....	201
Messer, CONVERSE.....	435	MILLIN, Prostatafasszange.....	550, 551	Nabelschnurklemme, COLLIN.....	605
Messer, COTTLE.....	435	Mini-Bulldogklemme, DeBAKEY-DIETRICH.....	101	Nabelschnurklemme, KANE.....	605
Messer, DEAN.....	372	Mini-Bulldogklemme, DIETRICH.....	101	Nabelschnurschere, BUSCH.....	64
Messer, FREER.....	434	Mini-Schnellkupplungshandgriff.....	301	Nabelschnurschere, MOD. USA.....	64
Messer, GRAFE.....	372	Mini-Skalpell.....	41	Nabelschnurschere, SCHUMACHER.....	64
Messer, JAEGER.....	372	Mini-Skalpellgriffe.....	41	Nadel, BARBARA.....	419
Messer, JOSEPH.....	434, 435	MINI-LAMBOTTE, Flachmeissel.....	262	Nadel, chirurgisch.....	222
Messer, KNAPP.....	372	MINI-TOWNSEND-DOWN, Biopsiezange.....	591	Nadel, REVERDIN.....	220
Messer, PAUFIQUE.....	373	MINI-TOWNSEND-UP, Biopsiezange.....	591	Nadel, ROSEN.....	419
Messer, PLESTER.....	418	MIXTER, Arterienklemme.....	116	Nadel, YOUNG-BOOMERANG.....	220
Messer, POLITZER.....	408	MIXTER, Gallensteinzange.....	530/2	Nadeldose.....	615
Messer, HADEO.....	435	MIXTER-BABY, Arterienklemme.....	119/1	Nadelelektrode, monopolar.....	628, 629
Messer, ROSEN.....	418	MIXTER-DeBAKEY, Gefäßklemme.....	499/2	Nadelführer, IOWA.....	206
Messer, SCHEIE.....	373	MIXTER-O-SHAUGNESSY, Arterienklemme.....	119/2	Nadelhalter, ADSON.....	211
Messer, SCHUKNECHT.....	418	Mobilisierhaken, TESSIER.....	463/3	Nadelhalter, ARRUGA.....	214
Messer, SEXTON.....	408	MOD. BONN, Nahtpinzette.....	387	Nadelhalter, BABY-OLSEN-HEGAR.....	212
Messer, TABB.....	418	MOD. TÜBINGEN, Fadenpinzette.....	392	Nadelhalter, BABY-WEBSTER.....	208
Messer, WHEELER.....	373	MOD. TÜBINGEN, Nahtpinzette.....	387	Nadelhalter, BARRAQUER.....	216, 217
Messer, WULLSTEIN.....	418	MOD. MÜNCHEN, Biopsiekürette.....	587	Nadelhalter, BARRAQUER -TROUTMAN.....	216
Messer, ZIEGLER.....	372, 373	MOD. VIENNA, Nasenspekula.....	421	Nadelhalter, BAUMGARTNER.....	208
Messer, Zwischenknochen.....	44	MOELTGEN, Winkelmesser.....	25	Nadelhalter, BOYNTON.....	214
Messgerät, IWANSON.....	624	MOGEN, Beschneidungsgerät.....	556	Nadelhalter, BOZEMANN.....	211
Messinstrumente.....	594	MOLLISON, Wundspreizer.....	171	Nadelhalter, BROWN.....	209
Messschieber.....	26	MOLT, Raspatorium.....	276	Nadelhalter, CASTROVIEJO.....	215, 216
Messsonde, HOUSE.....	420	Monopolare Elektrode.....	629	Nadelhalter, COLLIER.....	208
Messzirkel, CASTROVIEJO.....	380	Monopolare Pinzette.....	634	Nadelhalter, CRILE.....	213
Metallkatheter.....	555	MOOR, Gallensteininöföel.....	531	Nadelhalter, CRILE-MURRAY.....	209
Metallkatheter, COXETER.....	555	MOORE, Handbohrapparat.....	298	Nadelhalter, CRILE-WOOD.....	209
METZENBAUM, Nadelhalter.....	211	MOORFIELD, Nahtpinzette.....	392	Nadelhalter, DeBAKEY.....	210
METZENBAUM, Präparierschere.....	53 - 54	MORGAN, Proktoskop.....	565	Nadelhalter, DERF.....	208
METZENBAUM, Supercutschere.....	71	MORITZ-SCHMIDT, Zungenspatel.....	452	Nadelhalter, FINOCHIETTO.....	211
MEYER, Knochenhaltezange.....	248	MORRIS, Wundhaken.....	164	Nadelhalter, GILLIES.....	212
MEYERDING, Laminektomiespreizer.....	180	MORRIS-DeBAKEY, Aortaklemme.....	506	Nadelhalter, HALSEY.....	208
MEYERDING, Wundhaken.....	157, 177	MORSE, Rippensperrerr.....	484	Nadelhalter, HEANEY.....	210
MEYERDING, Wundspreizer.....	180	MORSE-FAVALORO, Rippensperrerr.....	484	Nadelhalter, HOESEL.....	213
MEYHOEFER, Chalzazionskürette.....	377	Motorfilifer.....	231/1	Nadelhalter, JACOBSEN.....	215
MICHEL, Kehlkopfspiegel.....	423	MOYNIHAN, Arterienklemme.....	120	Nadelhalter, JOHNSON.....	211
MICHEL, Wundklammern.....	224	MOYNIHAN, Gallensteinsonde.....	531	Nadelhalter, KALT.....	214
MICHEL, Wundklammerpinzette.....	224	MOYNIHAN, Tuchklemme.....	133	Nadelhalter, KALT-ARRUGA.....	214
MICHEL, Wundklammerzange.....	224	Mukosamesser, FREER.....	434	Nadelhalter, KILNER.....	212
Micro-FRIEDMANN, Hohlmeisselzange.....	234	MÜLLER, Approximator.....	364	Nadelhalter, LANGENBECK.....	213
Micro-HARTMANN, Arterienklemme.....	104	MÜLLER, Gefäßclip.....	365	Nadelhalter, LICHTENBERG.....	213
MICROVASCULAR, Nadelhalter.....	210	MUELLER, Lidsperrerr.....	371	Nadelhalter, MASSON.....	210
MIDDELDORPF, Wundhaken.....	160	Mundkeil, MAUNDER.....	459	Nadelhalter, MATHIEU.....	213
MIDDLETON-JANSEN, Septumzange.....	430	Mundsperrerr, DAVIS-BOYLE.....	455	Nadelhalter, MATHIEU-OLSEN.....	212
Mikro-chirurgische Pinzette.....	94	Mundsperrerr, DAVIS-MEYER.....	457	Nadelhalter, MAYO-HEGAR.....	209
Mikro-chirurgische Pinzette, GOMEL.....	96	Mundsperrerr, DENHART.....	454	Nadelhalter, METZENBAUM.....	211
Mikro-Fasszängchen, Rohrschaft.....	415	Mundsperrerr, DINGMANN.....	456	Nadelhalter, MICROVASCULAR.....	210
Mikro-Kanüle, ZÖLLNER u. WULLSTEIN Sauggriff.....	337/1	Mundsperrerr, DOYEN-JANSEN (MOLT).....	454	Nadelhalter, NEIVERT.....	208
Mikro-Löffelzängchen, Rohrschaft.....	416	Mundsperrerr, HEISTER.....	454	Nadelhalter, OLSEN-HEGAR.....	212
Mikro-Löffelzängchen, WULLSTEIN.....	416	Mundsperrerr, JENNINGS.....	454	Nadelhalter, RYDER.....	210
Mikro-Messsonde, HOUSE.....	420	Mundsperrerr, KILNER-DOUGHTY.....	456	Nadelhalter, SAROT.....	211
Mikro-Ohrscherchen, BELLUCCI.....	413, 417	Mundsperrerr, McIVOR.....	457	Nadelhalter, STEVENS.....	214
Mikro-Ohrscherchen, SHEA.....	413	Mundsperrerr, ROSER-KOENIG.....	454	Nadelhalter, STRATTE.....	212
Mikro-Ohrzängchen.....	413 - 416	MURDOCK, Lidsperrerr.....	370	Nadelhalter, WANGENSTEEN.....	210
Mikro-Ohrzängchen, COS.....	414	MURPHY, Wundhaken.....	156	Nadelhalter, WEBSTER.....	208
Mikro-Ohrzängchen, DIETER.....	414	MURPHY-LANE, Elevator.....	283	Nadelkasten.....	615
Mikro-Ohrzängchen, GREVEN.....	414	MUSEUX, Hakenzange.....	583	NAEGELE, Geburtszange.....	603
Mikro-Ohrzängchen, HAUGH.....	414	Muskelhaken.....	267	Nagelaussrisszange, RADOLF.....	297
Mikro-Ohrzängchen, JUERS.....	414	Muskelklemme, MASTIN.....	479	Nageldoppelfeile.....	612/1
Mikro-Ohrzängchen, McGEE.....	414	Muskelpinzette, BERKE.....	389	Nagelfeile.....	610
Mikro-Rohrschaftzange HADEO.....	474	Muskelpinzette, PRINCE.....	387	Nagelhaltzange.....	610, 613
Mikro-Schere, GOMEL.....	80	Muskelpinzette, SNELLEN.....	393	Nagelinstrument, INGROWN.....	612/1
Mikro-Schere, HEPP-SCHUIDEL.....	78	Muskelpinzette, TROUTMAN.....	389	Nagelschere.....	609, 610, 614
MIKULICZ, Darmklemme.....	543	Mutterschlüssel.....	313	Nagel-Set.....	609
MIKULICZ, Peritoneumklemme.....	123	MYLES, Nasenzange.....	427	Nagelsplitterinstrument.....	612/1
MIKULICZ, Wundhaken.....	163	Myomheber, DOYEN.....	594	Nagelzange.....	609, 612/2, 613, 614
MIKULICZ-BABY, Peritoneumklemme.....	123	Myommesser, SEGOND.....	594	Nagelzange, ANVIL.....	613
MILLER, Laryngoskop.....	30	Myrtenblattsönde.....	199	Nagelzange, TURNBULL.....	609
MILLER, Nasenraspel.....	444			NAGER, Tonsillennadel.....	466
MILLIGAN, Dura-Dissektor.....	332			NAGER, Wundhaken.....	465

Nahtbesteck.....	226	Nervhaken, ADSON.....	329	Ohrspekula, HARTMANN.....	399
Nahtpinzette, CASTROVIEJO.....	392	Nervhaken, CRILE.....	328	Ohrspekula, POLITZER.....	399
Nahtpinzette, MOD. BONN.....	387	Nervhaken, CUSHING.....	328	Ohrspekula, RICHNAU-HOLMGREN.....	400
Nahtpinzette, MOD. TUEBINGEN.....	387	Nervhaken, DANDY.....	328	Ohrspekula, SIEGLE.....	402
Nahtpinzette, MOORFIELD.....	392	Nervhaken, D'ERRICO.....	329/2	Ohrspekula, TOYNBEE.....	399
Nahtpinzette, St. MARTIN.....	392	Nervhaken, DeMARTEL.....	330	Ohrspekulahalter, LEYLA.....	368/3
Nasenflügelhäkchen, LANGE.....	448	Nervhaken, GRAHAM.....	329	Ohrspitze, REINER.....	406
Nasenhaken, AUFRICHT.....	447	Nervhaken, HESS.....	329/1	Ohrzängchen.....	413 - 416
Nasenhaken, CONVERSE.....	448	Nervhaken, HOLSHER.....	329/1	Ohrzängchen, COS.....	414
Nasenhaken, COTTLE.....	447, 447/1	Nervhaken, LOVE.....	329/2, 330	Ohrzängchen, GREVEN.....	414
Nasenhaken, FOMON.....	447/1	Nervhaken, SACHS.....	329	Ohrzängchen, HARTMANN.....	411, 412, 424
Nasenhaken, KILNER.....	447/1	Nervhaken, SCOVILLE.....	329/1, 330	Ohrzängchen, HARTMANN-HOFFMANN.....	412
Nasenhaken, MASING.....	447	Nervhaken, SMITHWICK.....	329	Ohrzängchen, HARTMANN-WULLSTEIN.....	412
Nasenhaken, MASING-NEVERT.....	447	Nervhaken, YASARGIL.....	330	Ohrzängchen, HAUGH.....	414
Nasenmeißel, WEST.....	442/1	Nervrädchen, WARTENBERG.....	25	Ohrzängchen, HEYMANN-KNIGHT.....	425
Nasennmesser, CONVERSE.....	435	Nervwurzelhaken, D'ERRICO.....	329/2	Ohrzängchen, JUERS.....	414
Nasennmesser, COTTLE.....	435	Nervwurzelhaken, HESS.....	329/1	Ohrzängchen, LITTAUER.....	411, 425
Nasennmesser, FREER.....	434	Nervwurzelhaken, LOVE.....	329/2, 330	Ohrzängchen, LUBET-BARBON.....	424
Nasennmesser, JOSEPH.....	434, 435	Nervwurzelhaken, SCOVILLE.....	329/1, 330	Ohrzängchen, McGEE.....	414
Nasenolive, POLITZER.....	406	Neuro-chirurgische Schere.....	65	Ohrzängchen, NOYES.....	425
Nasenpinzette, JANSEN.....	424	Neuro-chirurgische Schere, STRULLY.....	65	Ohrzängchen, STRUEMPEL.....	412
Nasenpinzette, JANSEN-GRUENWALD.....	424	NEWS, Trachealhaken.....	477	Ohrzängchen, TILLEY.....	411
Nasenpinzette, TROELTSCH.....	424	Nierenklemme, GUYON.....	122	Ohrzängchen, WESTMACOTT.....	424
Nasenaspel, AUFRICHT.....	443	Nierenerschale.....	619	Ohrzängchen, WULLSTEIN.....	416
Nasenaspel, FOMON.....	444	Nierensteinklemme, HERRICK.....	123	OLDBERG, Laminektomie-Zange.....	341/1
Nasenaspel, JOSEPH.....	443	Nierensteinzange, HEIMING.....	536	OLIVECRONA, Drahtsäge.....	332
Nasenaspel, JOSEPH (LEWIS).....	443	Nierensteinzange, RANDALL.....	535	OLIVECRONA, Dura-Dissektor.....	332
Nasenaspel, LEWIS.....	443	Nierenstielklemme, WERTHEIM-CULLEN.....	125	OLIVECRONA, Hirnspatel.....	336
Nasenaspel, MALTZ.....	443	NISSEN, Arterienklemme.....	113	OLIVECRONA, Hohlmeißelzange.....	237
Nasenaspel, MALTZ (COTTLE).....	444	NORFOLK/NORWICH, Wundspreizer.....	172	OLIVECRONA-TOENNIS, Anlegezange.....	326
Nasenaspel, MILLER.....	444	NORTHBENT, Fadenschere.....	66	OLLIER, Wundhaken.....	162
Nasenaspel, PEET.....	446	NOTO, Uterus-Polypenzange.....	585	OLSEN-HEGAR, Nadelhalter.....	212
Nasenaspel, WIENER.....	443	NOVAK, Biopsiekürlette.....	587	OMBREDANNE, Hammer.....	273
Nasensäge, JOSEPH.....	446	NOVOTEX, Hohlmeißel.....	264	Ophthalmologie-Schere, AEBLI.....	58
Nasenschere.....	429	NOYES, Augenschere.....	75	Ophthalmologie-Schere, GRADLE.....	57
Nasenschere, COTTLE.....	59	NOYES, Polypenzange.....	425	Ophthalmologie-Schere, STEVENS.....	58
Nasenschere, FOMON.....	58	Nystagmusbrille, FRENZEL.....	20	Ophthalmoskop, MAY UNI II.....	14
Nasenschere, HEYMANN.....	58	O.....		OP-Laryngoskop, HOLLINGER.....	37
Nasenspekula, COTTLE.....	423	Obduktions-Besteck.....	269	OP-Laryngoskop, JACKSON.....	37
Nasenspekula, HARTMANN.....	422	Oberarmmanschette.....	295	OP-Laryngoskop, KLEINSASSER.....	35
Nasenspekula, HARTMANN-HALLE.....	421	Oberschenkelmanschette.....	295	Organmesser.....	48
Nasenspekula, KILLIAN.....	423	OBWEGESER, Ahle.....	463, 463/3	Organ- und Gewebefäßzange, atrauma.....	111
Nasenspekula, MOD. VIENNA.....	421	OBWEGESER, Blattosteotom.....	464/1	oscillierende Gipssäge.....	230/10, 230/12
Nasenspekula, HADEO.....	423	OBWEGESER, Elevator.....	461/1	oscillierende Gipssäge m. Stababsauger.....	231
Nasenspekula, THUDICHUM.....	421	OBWEGESER, Osteotom.....	463, 464/1	Osteotom.....	259, 464
Nasenspekula, TIECK-HALLE.....	423	OBWEGESER, Raspator.....	462	Osteotom, COTTLE.....	440
Nasenspekula, VOLTOLINI.....	421	OBWEGESER, Wundhaken.....	460, 461/1	Osteotom, EPKER.....	464/2
Nasentamponzange, LUBET-BARBON.....	424	OCHSNER, Trokar.....	205	Osteotom, FOMON.....	441
Nasentamponzange, WESTMACOTT.....	424	O'CONNOR, Iriskäbchen.....	375	Osteotom, HIBBS.....	265
Nasenzange.....	431	OEHLER, chirurgische Pinzette.....	81/1	Osteotom, HOKE.....	265
Nasenzange, CAPLAN.....	428	Ohrhebel, ZAUFAL.....	409	Osteotom, HOKE.....	265
Nasenzange, GRAIG.....	426	Ohrhebel, ZAUFAL-JANSEN.....	409	Osteotom, LAMBOTTE.....	261
Nasenzange, HARTMANN.....	427	Ohrkatheter, HARTMANN.....	408	Osteotom, LEXER.....	263
Nasenzange, MIDDLETON-JANSEN.....	430	Ohrkürette, BUCK.....	407	Osteotom, MINI-LAMBOTTE.....	262
Nasenzange, MYLES.....	427	Ohrküffel, GROSS.....	409	Osteotom, NEVERT-ANDERSON.....	442
Nasenzange, RÜBIN.....	428	Ohrmesser, POLITZER.....	408	Osteotom, OBWEGESER.....	463, 464/1
Nasenzange, SCHMEDEN.....	427	Ohrmesser, SEXTON.....	408	Osteotom, RUBIN.....	440
Nasenzange, STRUYCKEN.....	427	Ohrpinzette JANSEN.....	424	Osteotom, SMITH-PETERSEN.....	261
Nasenzange, TAKAHASHI.....	427	Ohrpinzette JANSEN-GRUENWALD.....	424	Osteotom, STILLE.....	260
Nasenzange, WATSON-WILLIAMS.....	428	Ohrpinzette, LUCAE.....	410	Osteotom, WEST.....	442/1
Nasenzange, WEIL-BLAKESLEY.....	426	Ohrpinzette, TROELTSCH.....	410, 424	Osteotomklinge.....	266
NEFF, Meniskusmesser.....	292	Ohrpinzette, WILDE (TROELTSCH).....	410	OSTROEM, Knochenstanze.....	430
NEGUS, Bruststütze.....	459	Ohrschlinge, BILLEAU.....	409	O'SULLIVAN-O'CONNOR, Bauchdeckenhalter.....	181
NEGUS, Tonsillenzange.....	467	Ohrscherchen, BELLUCCI.....	413	O'SULLIVAN-O'CONNOR, Scheidenspekula.....	576
NEVERT, Nadelhalter.....	208	Ohrscherchen, SHEA.....	413	Oszillierende Gipssäge.....	230/10, 230/12
NEVERT-ANDERSON, Septummeißel.....	442	Ohrscherchen, WULLSTEIN.....	417	OTIS, Urethrotom.....	553
NELATON, Hohlsonde.....	199	Ohrschlinge, LANGENBECK.....	409	Otoskop Diagnostik-Besteck, UNI I.....	13
NELSON, Gefäßspinzette.....	89	Ohrschlinge, SHAPLEIGH.....	410	OVERHOLT, Arterienklemme.....	114
NELSON, Trokar.....	205	Ohrsonde, STACKE.....	199	OVERHOLT-BABY, Arterienklemme.....	114
NELSON, Unterbindungsnadel.....	219	Ohrspekula, BOUCHERON.....	399	OVERHOLT-GEISENDOERFER, Arterienklemme.....	114
NEONATAL, Atramaklemme.....	523	Ohrspekula, BRUEHINGES.....	401	OVERHOLT-MIXTER, Arterienklemme.....	115
Neonatal-Gefäßklemme, CASTANEDA.....	527	Ohrspekula, GRUBER.....	399		
Nervhäkchen, KRAYENBUEHL.....	336				

P	Pinzette, BISHOP-HARMAN	88	Pinzette, STILLE-BARRAYA	88	
PALMER-POZZI, Hakenzange.....	582	Pinzette, BONACCOLTO	385	Pinzette, St. MARTIN.....	392
Parametriummklemme, HADEO.....	128/1	Pinzette, BONNEY	88	Pinzette, STRASSBURGER MODELL	89
Parametriumschere TC.....	63	Pinzette, BROPHY	84	Pinzette, TAYLOR	87
Parazentesenadel, LUCAE	408	Pinzette, BROWN	83	Pinzette, TERSON	391
Parazentesenadel, POLITZER	408	Pinzette, CARMALT	91	Pinzette, TROELTSCH	424
PARK, Lidsperrerr	371	Pinzette, CASTROVIEJO	390 - 392	Pinzette, TROUTMAN	389
PARKER, Wundhaken	139	Pinzette, COLLIN-DUVAL	85	Pinzette, Tumor.....	97
PARKER-LANGENBECK, Wundhaken.....	141	Pinzette, COTTLE	410	Pinzette, Uhrmacher.....	90
PARTSCH, Flachmeissel	259	Pinzette, CUSHING	83	Pinzette, Ultra-light	95
PARTSCH, Hammer	271	Pinzette, CUSHING-TAYLOR	87	Pinzette, USA	81/1
PARTSCH, Hohlimeissel.....	259	Pinzette, DASTOOR	386	Pinzette, WAGENSTEEN	89
PASSOW, Blutstillungsmeissel	260	Pinzette, DAVIS	227	Pinzette, WAUGH	83
PATELLA, Knochenhaltezange	248	Pinzette, DeBAKEY	98, 99	Pinzette, WILDE (TROELTSCH).....	410
PAFON, Hornhautdissektor	373	Pinzette, DESMARRES.....	393	Pinzette, YASARGIL	97
PAUFIQUE, Fadenpinzette	392	Pinzette, DOUGLAS	395	PIPEP, Geburtszange	604
PAUFIQUE, Keratoplastik-Messer	373	Pinzette, DUEHRSEN	84	Pistole f. Reinigung	626
PAYR, Darmquetschklemme	548	Pinzette, DURANTE	88	Plastik-Hammer	271
PAYR, Führungshohlsonde	221/1	Pinzette, DUVAL	85	Plazentabecken	621/1
PAYR-BABY, Darmquetschklemme.....	548	Pinzette, ELSCHNIG	389, 391	PLESTER, Messer	418
PEAN, Arterienklemme	108, 110	Pinzette, FEILCHENFELD	91	PLESTER, Saugrohr	338
PEAPOD, Rongeur	341/1	Pinzette, FERRIS-SMITH	85	PLESTER, Wundspreizer	171
PECK-JOSEPH Präparierschere	74	Pinzette, FISCHER	384	POLITZER, Gummibirne	406
PEDERSON, Scheidenspekula	570	Pinzette, FOERSTER	383	POLITZER, Luftdusche	406
PENFIELD, Dissektor.....	333	Pinzette, FUCHS	391	POLITZER, Nasenolive	406
PEERS, Tuchklemme.....	132	Pinzette, GERALD	85, 86	POLITZER, Ohrmesser	408
PEET, Nasenraspel	446	Pinzette, GILL	384	POLITZER, Ohrspekula	399
PEET, Splitterzange	92	Pinzette, GILL-ARRUGA	390	POLITZER, Parazentesse-Nadel	408
PELKMANN, Tupferzange	137	Pinzette, GILL-HESS	384	Polster f. Oberarm- u. Oberschenkelmanschette	295
Pelvis-Haken, St. MARKS	165	Pinzette, GILLIES	86	Polypenschlinge	411
Penisklemme, STOCKMANN	553/1	Pinzette, GOMEL	96	Polypenschnürer, KRAUSE	411, 433/2
Penisklemme, STRAUSS	553/1	Pinzette, GRADLE	395	Polypenschnürer, KRAUSE-VOSS	433/2
PENNINGTON, Arterienklemme	109	Pinzette, GRAEFE	83, 382, 389	Polypenschnürer, WILDE	411, 433/2
PENNINGTON, Septumelevator	438	Pinzette, GREEN	390	Polypenzange, BRUENINGS	425
PERCY, Retraktor	296	Pinzette, HESS	384, 391	Polypenzange, HARTMANN	424
Perforatorie, SMELLIE	607	Pinzette, HUNT	97	Polypenzange, HEYMANN	425
Peripheral-Gefässklemme, DeBAKEY	494	Pinzette, HUNTER	91	Polypenzange, HEYMANN-KNIGHT	425
Peripheral-Gefässklemme, LELAND-JONES	494	Pinzette, JACKSON	471	Polypenzange, JURASZ	471
Peritoneumklemme, FAURE	123	Pinzette, JAMESON	385	Polypenzange, KNIGHT	425
Peritoneumklemme, MIKULICZ	123	Pinzette, JANSEN	424	Polypenzange, LITTAUER	425
Peritoneumklemme, PHANEUF	123	Pinzette, JANSEN-GRUENWALD	424	Polypenzange, LUBET-BARBON	424
PERKINS, Wundspreizer	168	Pinzette, KALT	391	Polypenzange, NOYES	425
Perkussionshammer, BABINSKY	24	Pinzette, KIRBY-ARTHUR	385	Polypenzange, WESTMACOTT	424
Perkussionshammer, BERLINER	24	Pinzette, KNAPP-LUER	393	POOLE, Saugrohr	27
Perkussionshammer, BUCK	24	Pinzette, LANE	84	POST MORTEM	269
Perkussionshammer, TAYLOR	24	Pinzette, LERCHE	83	POTTS, Anastomosen-Klemme	493
Perkussionshammer, TROEMNER	24	Pinzette, LESTER	389	POTTS, Coarctations-Klemme	492
PERTHES, Pfiem	304	Pinzette, LITTAUER	395	POTTS, Gefässklemme	492, 493
PESTALOZZA, Abortuskürette	606	Pinzette, LONDON-COLLEGE	93	POTTS-DeMARTEL, Gefässschere	59
PETRI, Schale.....	620	Pinzette, LUCAE	410	POTTS-SMITH, anatomische Pinzette.....	81
PETZ, Magen- und Darmnähapparat	549	Pinzette, MAYO	89	POTTS-SMITH, chirurgische Pinzette	81
Pfiem	304	Pinzette, McCULLOUGH	385	POTTS-SMITH, Gefässschere	61
Pfiem, PERTHES	304	Pinzette, McINDOE	85	POZZI-PALMER, Hakenzange	582
Phalagenmesser	44	Pinzette, MCPHERSON	392	Präparierschere	52
PHANEUF, Peritoneumklemme	123	Pinzette, MERIAM	93	Präparierschere, DEAUER	52
PIERCE, Kieferhöhlentroktr	204	Pinzette, Mikrochirurgie	94, 96	Präparierschere, JORGENSEN	53
PIERCE, Septumelevator	438	Pinzette, MOD. BONN	387	Präparierschere, LEXER	53
PIFFARD, Lupuskürette	608	Pinzette, MOD. TÜBINGEN	387, 392	Präparierschere, LEXER-BABY	53
PILLING, Ciljanlegezange	524, 525	Pinzette, Monopolar	634	Präparierschere, MAYO	52/1
PINARD, Stethoskop	23	Pinzette, MOORFIELD	392	Präparierschere, MAYO-NOBLE	52/1
Pinzette, ADLERKREUTZ	84	Pinzette, NELSON	89	Präparierschere, MAYO-STILLE	52/1
Pinzette, ADSON	81/2, 82, 334	Pinzette, OCHSNER	88	Präparierschere, METZENBAUM	53/1
Pinzette, ADSON-BROWN	82	Pinzette, OEHLER	81/1	Präparierschere, METZENBAUM FINO	53/1
Pinzette, ADSON-DeBAKEY	81/2	Pinzette, PAUFIQUE	392	Präparierschere, PECK-JOSEPH	74
Pinzette, anatomisch.....	81	Pinzette, POTTS-SMITH	81	Präparierschere, TOENNIS-ADSON	65
Pinzette, ARRUGA	391	Pinzette, PRINCE	387	Präparierschere, WELLER	53/2
Pinzette, atrauma	98, 99	Pinzette, HADEO	395	PRATT, Dilator	580
Pinzette, AYER	393	Pinzette, SCHWEIGGER	391	PRATT, Fasszange	110
Pinzette, BARRAQUER	384, 390, 395	Pinzette, SEMKEN	86	PRATT, Fistelsonde	563
Pinzette, BARRAQUER-KATZIN	384	Pinzette, SINGLEY	88	PRATT, Hakenzange	584
Pinzette, BEER	395	Pinzette, SNELLEN	393	PRATT, Mastdarm-Spekula	559
Pinzette, BERKE	389	Pinzette, STEVENS	383	PRATT, Uterus-Dilatator	580
Pinzette, bipolar	630 - 632	Pinzette, STILLE	81	PRECISA, Blutdruckmessgerät	9

PRESBYTERIAN, Schlauchklemme	129	Raspel, GALLAHER	446	Ringmesser, LAFORCE	450
PRICE-THOMAS, Bronchusklemme	490	Raspel, JOSEPH	443, 446	Ringmesser, St. CLAIR-THOMSON	450
PRINCE, Muskelpinzette	387	Raspel, JOSEPH (LEWIS)	443	Rippenkontraktor, BAILEY	489/1
PRINCE, Tonsillenscherer	59	Raspel, MALTZ	443	Rippenkontraktor, BAILEY-BABY	489/1
PROBE AND PACKER	612	Raspel, MALTZ (COTTLE)	444	Rippenkontraktor, BAILEY-GIBBON	489/1
Profundaklemme, GREGORY	517	Raspel, MILLER	444	Rippenkontraktor, SELLORS	489/1
Proktoskop, BENSAUDE	565	Raspel, PEET	446	Rippenscherer	480
Proktoskop, CHELSEA-EATON	563	Raspel, WIENER	443	Rippenscherer, BETHUNE	481
Proktoskop, FANSLER	564	Rauchabsaugrohr, KLEINSASSER	36	Rippenscherer, BRUNNER	481
Proktoskop, HIRSCHMANN	563	RAY, Hypophysenkürette	334	Rippenscherer, COLLIN	480
Proktoskop, IVES-FANSLER	563	RECAMIER, Uteruskürette	597, 598	Rippenscherer, CORYLLOS	480
Proktoskop, KELLY	563, 564	Recordspritze	596	Rippenscherer, GIERTZ-STILLE	481
Proktoskop, MORGAN	565	HADEO, Amputationsmesser	44	Rippenscherer, GLUCK	480
Prostatafasszange, MILLIN	550, 551	HADEO, Augenmagnet	395	Rippenscherer, SAUERBRUCH	481
Prostatahaken, YOUNG	550	HADEO, Cilienpinzette	395	Rippenscherer, SAUERBRUCH-FREY	481
PROVIDENCE-HOSPITAL, Arterienklemme	106	HADEO, EXCENTER, Verbandschere	69/2	Rippenscherer, STILLE	480
Pulverbläser, KABERSKE	405	HADEO, Fadengabel	221	Rippensperrer, CHERRY	488
Pulverbläser, UNIVERSAL	405	HADEO, Fingerringssäge	297	Rippensperrer, COOLEY	485, 487
Pumpe f. Komprimierer	295	HADEO, Führungshohlsonde	221/1	Rippensperrer, COOLEY-NEONATAL	485
Punktionskanüle, FRAZIER	337	HADEO, Gipsspreizer	232	Rippensperrer, DeBOER	486
PUTTI, Knochenraspel	294	HADEO, Handbohrapparat	300	Rippensperrer, FINOCHIETTO	482, 484
Pylorusspreizer, BENSON	544	HADEO, Hauthäkchen	150	Rippensperrer, FINOCHIETTO-BABY	482
		HADEO, Kappenzange	615	Rippensperrer, FINOCHIETTO-BURFORD	483
Q		HADEO, Klingenbrecher	45	Rippensperrer, HAIGHT	487
QUERVAIN, Elevator	275	HADEO, Knochenhaltezange	246, 247	Rippensperrer, MORSE	484
QUINBY, Zahnfleischschere	67	HADEO, Mikro-Rohrschaftzange	474	Rippensperrer, MORSE-FAVALORO	484
QUIRE, Fremdkörperhebel	412	HADEO, Nasenspekulum	423	Rippensperrer, RIENHOFF-FINOCHIETTO	486
QUISLING, Hammer	271	HADEO, Organ- u. Gewebefäßzange	111	Rippensperrer, TUFFIER	487
		HADEO, Parametriummklemme	128/1	RITTER-HALLE, Stirnhöhliendilatator	433
		HADEO, Parametriumschere	63	ROBB, Spatel	530/1
R		HADEO, scharfer Löffel	256	ROBERTS, Arterienklemme	117
Rachiotom	267	HADEO, Sichelmesser	435	ROCHARD, Bauchdeckenhalter	186
RADOLF, Nagelausschneidzange	297	HADEO, Watteträger	203	ROCHARD, Fixiervorrichtung	186
RAGNELL, Wundhaken	140	REDON, Führungsnaht	207	ROCHESTER-CARMALT, Arterienklemme	109
Rahmen, DENIS-BROWNE, Bauchdeckenhalter	185	REES, Face-Lift-Schere	73	ROCHESTER-OCHSNER, Arterienklemme	108
Rahmen, KIRSCHNER, Bauchdeckenhalter	185 - 187/1	Reibzähle	304	ROCHESTER-PEAN, Arterienklemme	108
Rahmen, O'SULLIVAN-O'CONNOR	576	REICHERT, Kehledeckelhalter	471	ROEDER, Tuckklemme	132
RALK, Handbohrapparat	300	REILL, Knochenhaltezange	248	ROGER, Septumelevator	437
RAMPLEY, Tupferzange	136	REINER, Gipsmesser	233	ROGERS, Hysterektomieklammer	127
RAMUS, Wundhaken	461	REINER, Ohrspritze	406	ROGGE, Sterilisierzange	227
RANDALL, Biopsiekürette	587	Reinigungsaufsatz	626	Rohrschaftszange, HADEO	474
RANDALL, Nierensteinzange	535	Reinigungspistole	626	Rollenklemme	131
RANEY, Klammeranlagezange	327	Rektal-Absaugrohr, BUJE	566	Rollenklemme, BÜLOW-GUNAR-HEY	130
RANEY, Kopfhautklammern	327	Rektal-Schnürer, WESTON	566	ROLLET, Exstipationsmeißel	374
Rasierklängen	45	Rektal-Spekulum, SAWYER	560	ROLLET, Tränensackhäkchen	375
Rasiermesser	49	Rektal-Spekulum, HILL-FERGUSON	560	Rongeur, CLOWARD	342
Raspatorium	279	Rektum-Anastosenklemme, HAYES	545	Rongeur, CUSHING	340
Raspatorium, ADSON	282	Repositionszange, ROWE	459	Rongeur, DECKER	341
Raspatorium, ALEXANDER	276	RESANO, Darmklemme	542	Rongeur, FERRIS-SMITH	343
Raspatorium, COBB	280	RESANO, Kapselschere	53/2	Rongeur, LANDOLT	341/2
Raspatorium, DINGMANN	463, 463/3	Resektionsmesser	47	Rongeur, LOVE-GRUENWALD	340
Raspatorium, DOYEN	278	Retraktor	463/4	Rongeur, OLDBERG	341/1
Raspatorium, FARABEUF	274	Retraktor, PERCY	296	Rongeur, PEAPOD	341/1
Raspatorium, FARABEUF-COLLIN	274	Retraktoren, Intraoral	463/1, 463/4	Rongeur, SCHLESINGER	342
Raspatorium, FOMON	277	Retraktor-System, LEYLA	368 - 368/4	Rongeur, SPURLING	340
Raspatorium, GUILLEN	433/1	REVERDIN, Darmspatel	143/3	Rongeur, WAGNER	343
Raspatorium, HARGIS	463/2	REVERDIN, Nadel	220	ROSE, Wundhaken	140
Raspatorium, JOSEPH	277	REYNOLDS, chirurgische Schere	54/1	ROSEN, Messer	418
Raspatorium, KÖNIG	276	REYNOLDS, Supercuttschere	72	ROSEN, Nadel	419
Raspatorium, LAMBOTTE	274	Rhinoplastikschere, FOMON	65/1	ROSEN, Saugkanüle	338
Raspatorium, LANGENBECK	275	RIBBON, Bauch- u. Darmspatel	143/1	ROSER-KOENIG, Mundsperrerr	454
Raspatorium, QUERVAIN	279	RICARD, Bauchdeckenhalter	191	ROSS, Aortahaken	148/1
Raspatorium, MATSON-ALEXANDER	279	RICHARDSON, Wundhaken	142	ROUX-BABY, Wundhaken	140
Raspatorium, MOLT	276	RICHARDSON-EASTMAN, Wundhaken	142	ROUX MINI, Wundhaken	140
Raspatorium, OBWEGESER	462	RICHARDSON-GRIP, Wundhaken	142	ROUX, Wundhaken	139
Raspatorium, QUERVAIN	275	RICHNAU-HOLMGREN, Ohrspekula	400	ROWE, Repositionszange	459
Raspatorium, SEBILAU	275	RICHTER-HEATH, Wundklammerzange	224	RUBIN, Septummeißel	440
Raspatorium, SEDILLOT	274, 275	RIENHOFF-FINOCHIETTO, Rippensperrer	486	RUBIN, Septumzange	428
Raspatorium, SELDIN	277	RIGBY, Bauchdeckenhalter	189/2	RUMEL, Hämorrhoidal-Ligatur	568
Raspatorium, SEMB	278	RI-MINI, Diagnostik-Besteck	17	RUMEL, Arterienklemme	117
Raspatorium, WILLIGER	276	RING, Zungenspatel	455	RUMEL-BELMONT, Tourniquet	528
Raspatorium, MOLT	276	Ringmesser, BARNHILL	450	RUMEL-DeBAKEY, Gefäßklemme	499
Raspel, AUFRICHT	443	Ringmesser, BECKMANN	450	RUSKIN, Hohlmeißelzange	239
Raspel, FOMON	444, 445				

RUSKIN-LISTON, Knochensplitterzange	241	Scharfer Löffel, BUSHE	256	Schere, HEPP-SCHEIDEL	78
RUSSEL-DAVIS, Zungenspatel	458	Scharfer Löffel, COBB	252	Schere, HEYMANN	58
RUSSISCHES MODELL, Fasspinzette	85	Scharfer Löffel, DAUBENSPECK	255	Schere, IRIS	54/2, 72
RYDEL-SEIFFERT, Stimmgabel	404	Scharfer Löffel, HALLE	253	Schere, JORGENSEN	53
RYDER, Nadelhalter	210	Scharfer Löffel, JACOBSON	257	Schere, JOSEPH	54/1
S		Scharfer Löffel, JANSEN	257	Schere, KAYE	73
Säge, GIGLI	332	Scharfer Löffel, LEMPERS	256	Schere, KELLY	61
Sägeblatt	230/14 - 230/17	Scharfer Löffel, MARTINI	257	Schere, KILLIAN	471
Sägeblatt, Fingerringssäge	297	Scharfer Löffel, HADEO	256	Schere, KILNER	54/1
SAALFELD, Komedonenquetscher	608	Scharfer Löffel, SCHEDE	251	Schere, KILNER/RAGNELL	72
SACHS, Dura-Dissektor	332	Scharfer Löffel, SCOVILLE	253	Schere, KLINKENBERGH-LOTH	65/2
SACHS, Nervhaken	329	Scharfer Löffel, SPINAL	253	Schere, KNAPP	55
SAENGER, Abortuszange	606	Scharfer Löffel, SPRATT	251	Schere, KNOWLES	70
Sagittalspreizer, SMITH	463/5	Scharfer Löffel, VOLKMANN	257	Schere, LA GRANGE	69, 72
Salpingograph, SCHULTZE	596	Scharfer Löffel, WILLIGER	255, 257	Schere, LANDOLT	58
SANVENERO, chirurgische Schere	54/1	SCHEDE, scharfer Löffel	251	Schere, LEXER	53
SAROT, Arterienklemme	118	Scheidenspekula	569 - 577	Schere, LEXER-BABY	53
SAROT, Nadelhalter	211	Scheidenspekula, AUVARD	576	Schere, Ligatur, TC	54
SATINSKY, Gefäßklemme	491	Scheidenspekula, BREISKY	577	Schere, LISTER	69/1, 72
SATINSKY, Gefäßschere	65/2	Scheidenspekula, COLLIN	570	Schere, LITTAUER	66
SATINSKY, Tangentialklemme	502	Scheidenspekula, CUSCO	570, 571	Schere, LITTLER	55
SATO, Hornhautmesser	373	Scheidenspekula, DELEE	574	Schere, LOCKLIN	69
Sattelhäkchen	151, 152	Scheidenspekula, DOYEN	574	Schere, LORENZ	70
Sattelhäkchen, CUSHING	151, 152	Scheidenspekula, GRAVE	570	Schere, MARTIN	65/1
Sattelhäkchen, DESMARRÉS	151	Scheidenspekula, JACKSON	573	Schere, MAYO	52/1, 71
Sattelhäkchen, GIL-VERNET	152	Scheidenspekula, KALLMORGEN	573	Schere, MAYO-NOBLE	52/1
SATTERLEE, Amputationssäge	296	Scheidenspekula, KRISTELLER	572	Schere, MAYO-STILLE	52/1, 71
SAUERBRUCH, Abfallzange	227	Scheidenspekula, LANDAU	577	Schere, MCINDOE	65/1
SAUERBRUCH, Hohlmeisselzange	240	Scheidenspekula, O'SULLIVAN-O'CONNOR	576	Schere, METZENBAUM	53/1, 54, 71
SAUERBRUCH, Rippenschere	481	Scheidenspekula, PEDERSON	570	Schere, MIKRO	76
SAUERBRUCH, Wundhaken	164, 166	Scheidenspekula, SCHERBAK	575	Schere, Nagel	609, 610
SAUERBRUCH-FREY, Rippenschere	481	Scheidenspekula, SEMM	571	Schere, Neurochirurgie	65
Sauggriff, WULLSTEIN	338	Scheidenspekula, SIMS	573	Schere, NORTHBENT	66
Saugkanüle, ROSEN	338	Scheidenspekula, TRELAT	571	Schere, NOYES	75
Saugkanüle, SCHMID	338	Scheidenspekula, VU-MORE	569	Schere, Parametrium	63
Saugkurette, NOVAK	587	SCHIEIE, Goniotomiemesser	373	Schere, PECK-JOSEPH	74
Saugkurette, RANDALL	587	SCHIEINMANN, Aufsatz	472	Schere, POTTS-DeMARTEL	59
Saugraspatorium, GUILÉN	433/1	SCHERBAK, Scheidenspekula	575	Schere, POTTS-SMITH	60, 61
Saugrohr	337/1	Schere, AEBLI	58	Schere, PRINCE	59
Saugrohr, ADSON	337	Schere, BABY-METZENBAUM	71	Schere, QUINBY	67
Saugrohr, ANDREW-PYNCHON	28	Schere, BARRAQUER	75	Schere, HADEO	77, 80
Saugrohr, BABY-YANKAUER	27	Schere, BEEBEE	68	Schere, HADEO EXCENTER	69/2
Saugrohr, BARON	336	Schere, BERGMANN	69/1	Schere, REES	73
Saugrohr, COOLEY	28	Schere, BETHUNE	481	Schere, RESANO	53/2
Saugrohr, DeBAKEY	28	Schere, BOETTCHER	59	Schere, REYNOLDS	54/1, 72
Saugrohr, FERGUSSON	337	Schere, BRAUN-STADLER	64	Schere, SANVENERO	54/1
Saugrohr, FRAZIER/FERGUSSON	337	Schere, BRUNNER	481	Schere, SATINSKY	65/2
Saugrohr, HOUSE	337/2	Schere, BRUNS	70	Schere, SAUERBRUCH	481
Saugrohr, PLESTER	338	Schere, BUSCH	64	Schere, SAUERBRUCH-FREY	481
Saugrohr, POOLE	27	Schere, CASTROVIEJO	79	Schere, SCHMIEDEN-TAYLOR	65/1
Saugrohr, ROSEN	338	Schere, COLLIN	480	Schere, SCHUMACHER	64, 481
Saugrohr, SCHMID	338	Schere, COTTLE	56, 59	Schere, SEUTIN	69/2
Saugrohr, YANKAUER	27	Schere, CORYLLOS	480	Schere, SIEBOLD	62
Saugrohr, YASARGIL	337/1	Schere, CRAFT	65/2	Schere, SIMS	62
Saugrohr, ZÖLLNER	337/1	Schere, DEAN	59	Schere, SMITH-US-ARMY	69/1
Saugschlauch	231	Schere, DeBAKEY	60, 61	Schere, Standard	51
SAWTELL, Tonsillenzange	467	Schere, DIETRICH	60	Schere, STILLE	480
SAWYER, Rektal-Spekulum	560	Schere, DOYEN	63	Schere, STEVENS	58, 72
SAYRE, Elevator	281	Schere, DUBOIS	63	Schere, STRULLY	65
SCAGLIETTI, Hohlmeisselzange	240	Schere, ESMARCH	69/2	Schere, SYSTRUNK	66
SCALP-CONTOUR, Wundspreizer	169	Schere, FAVALORO	61	Schere, THOREK	65/2
Schädelhalter, CRUTCHFIELD	327	Schere, FERGUSSON	66	Schere, TOENNIS-ADSON	65
Schädelspalter	267	Schere, FOMON	58, 65/1	Schere, UNIVERSAL	67, 70
Schädelstanze, CONE	331	Schere, FREEMAN	74	Schere, USA Mod.	64
Schädelzange, DeVILBISS	332	Schere, GLUCK	480	Schere, VANNAS	79
SCHAEDEL, Tuchklemme	132	Schere, GOLDMAN-FOX	67	Schere, WAGNER	67, 72
Schaft	230/4, 230/7	Schere, GOMEL	80	Schere, WALDMANN	64
Schale, PETRI	620	Schere, GOOD	59	Schere, WECKER	75
Schälmesser, Tracheotomie	475	Schere, GORNEY	73	Schere, WELLER	53/2
SCHAMBERG, Komedonenquetscher	608	Schere, GRADLE	57	Schere, WERTHEIM	63
Scharfer Löffel	255	Schere, GRAEFE	56	Schere, WESTCOTT	75
Scharfer Löffel, BRUNS	251, 254	Schere, Haut	610	Schieblehre, TOWNLEY	26
		Schere, HEATH	66	Schielhaken, GRAEFE	375

Schielhaken, JAMESON.....	375	Sehenschäler, BUNNELL.....	292	Siebschale.....	623
Schildrüsenhaken, SCHOENBORN.....	479	SEIFERT, Aufsatz.....	472	SIEGLE, Ohrspekula.....	402
SCHIMMELBUSCH, Verbandstofftrommel.....	622	SEKTIONSADDEL.....	268	Silberklammern.....	326
SCHINK, Dermatome.....	49	SELDIN, Rasporator.....	277	Silikoneinlage, DAVIS-BOYLE.....	455
SCHIOETZ, Tonometer.....	394/2	SELECT, Verbindungskabel.....	633	Silikonschlauch, McIVOR.....	457
Schlauchhalterung.....	188	SELLHEIM, Geburtsöffel.....	607	SILVER, Dermatome.....	50
Schlauchklemme.....	129	SELLORS, Rippenkontraktor.....	489/1	SILVER, Septummeißel.....	442
Schlauchklemme, BÜLOW-GUNAR-HEY.....	130	SEMB, Bronchusklemme.....	491	SIMCOE, Spülkanüle.....	394/2
Schlauchklemme, HOFFMANN.....	624	SEMB, Hohlmeißelzange.....	240	SIMON, Uterusöffel.....	594
Schlauchklemme, KLINIKUM BERLIN.....	129	SEMB, Knochenhalte-zange.....	243	SIMON, Wundhaken.....	164
Schlauchklemme, PRESBYTERIAN.....	129	SEMB, Knochensplitterzange.....	242	SIMPLEX, Schlauchklemme.....	624
Schlauchklemme, SIMPLEX.....	624	SEMB, Rasporator.....	278	SIMPSON, Geburtszange.....	602
Schlauchverbindungsstück.....	600	SEMB, anatomische Pinzette.....	86	SIMPSON-BRAUN, Geburtszange.....	602
SCHLESINGER, Laminektomie-zange.....	342	SEMKEN, chirurgische Pinzette.....	86	SIMPSON-LUIKART, Geburtszange.....	603
Schliessklemme, STONE.....	545	SEMM, Scheidenspekula.....	571	SIMS, gynäkologische Schere.....	62
Schlinge, Polypenschürer.....	433/2	SENN-GREEN, Wundhaken.....	153	SIMS, Mastdarm-Spekula.....	559
Schlüssel, Meißel.....	266	SENN-MILLER, Wundhaken.....	143	SIMS, Scheidenspekula.....	573
Schlüssel, Osteotome.....	266	Septemzange, KNIGHT.....	425	SIMS, Sonde.....	586
Schlüsselpaar, Gips-säge u. Autopsiesäge.....	230/18	Septemzange, HEYMANN.....	425	SIMS, Uterusdepressor.....	586
SCHMEDEN, Nasenzange.....	427	Septumhohlmeißel, FREER.....	442/1	SIMS, Uterusdilatorator.....	581
SCHMID, Gefäß- u. Spülkanüle.....	338	Septumhohlmeißel, HAJEK.....	442/1	SIMS, Uteruskürre.....	597, 598
SCHMIEDEN, Führungshohlsonde.....	221	Septumhohlmeißel, KILLIAN-CLAUS.....	442/1	SIMS, Uterussonde.....	586
SCHMIEDEN-DICK, Unterbindungsnadel.....	219	Septumelevator, BALLENGER.....	439	SIMS-MAIER, Kornzange.....	134
SCHMIEDEN-TAYLOR, Duraschere.....	65/1	Septumelevator, COTTLE.....	439	SINGLEY, Gewebefasspinzette.....	88
Schnellkupplungs-Handgriff.....	301	Septumelevator, COTTLE-JOSEPH.....	439	SINOSKOPIE-TROKAR.....	205
Schnellkupplungs-T-Handgriff.....	300, 301	Septumelevator, FREER.....	437, 439	SINSKEY, Häkchen.....	376
SCHNIDT, Tonsillenzange.....	467	Septumelevator, HAJEK-BALLENGER.....	439	SINUS, Septumelevator.....	438
SCHOENBORN, Schildrüsenhaken.....	479	Septumelevator, HALLE.....	437	Sinuskopie-Zange.....	531
Schraubenhalte-hülse.....	324	Septumelevator, HOWARTH.....	438	Skalpelle Mini.....	41
Schraubenhalte-zange, LANE.....	325	Septumelevator, JOSEPH.....	437	Skalpelle, steril.....	43
Schraubenzieher, Ferrozellgriff.....	323	Septumelevator, KILLIAN.....	438, 439	Skalpellgriff.....	38 - 42
Schraubenzieher, LANE.....	323, 324	Septumelevator, McKENTY.....	437, 438	Skalpellgriff Mini.....	41
Schraubenzieher, WILLIAMS.....	323	Septumelevator, PENNINGTON.....	438	Skalpellklingen.....	42
SCHRÖDER, Hakenzange.....	584	Septumelevator, PIERCE.....	438	Skalpellklingen-Entferner.....	42
SCHRÖDER, Uterusöffel.....	595	Septumelevator, ROGER.....	437	SKENE, Hakenzange.....	582
SCHROEDER, Hakenzange.....	583	Septumelevator, SINUS.....	438	Sklerotom, GUYTON-LUNDSSGAARD.....	373
SCHROEDER (POZZI), Hakenzange.....	582	Septumelevator, CINELLI.....	441	Sklerotom, LUNDSSGAARD.....	373
SCHUBERT, Biopsiezange.....	588	Septummeißel, COTTLE.....	440	SLS, Clipanlegezange.....	524, 525
SCHUKNECHT, Messer.....	418	Septummeißel, FOMON.....	441	SLUDER-BALLENGER, Tonsillotom.....	470
SCHULTZE, Salpingograph.....	596	Septummeißel, FREER.....	439	SMELLIE, Haken.....	605
SCHULZE-BERGMANN, Mastdarm-Spekula.....	560	Septummeißel, NEIVERT-ANDERSON.....	442	SMELLIE, Perforatorie.....	607
SCHUMACHER, Aufsatz.....	472	Septummeißel, RUBIN.....	440	SMILLIE, Knochenhebel.....	291
SCHUMACHER, Biopsiezange.....	588	Septummeißel, SHEEHAN.....	441	SMILLIE, Meniskusmesser.....	292
SCHUMACHER, Nabelschnurschere.....	64	Septummeißel, SILVER.....	442	SMITH, Lidsperrerr.....	370
SCHUMACHER, Sternschnurschere.....	481	Septumostetom, CINELLI.....	441	SMITH, Sagittalspreizer.....	463/5
SCHUMACHER, Uterus-Biopsiezange.....	589	Septumostetom, FOMON.....	441	SMITH, Spreizer.....	463/5
Schlüssel.....	619	Septumostetom, SHEEHAN.....	441	SMITH, Spreizzange.....	463
Schwammzange.....	136	Septumrichtzange, ASCH.....	449	SMITH US ARMY, Verbandschere.....	69/1
Schwammzange, FOERSTER.....	136	Septumrichtzange, WALSHAM.....	449	SMITH-BUIE, Analspreizer.....	561
Schwammzange, RAMPLEY.....	136	Septumschere, KILLIAN.....	471	SMITH-PETERSEN, Hohlmeißel.....	261
SCHWEIGGER, Kapselpinzette.....	391	Septumzange, BRUENINGS.....	425	SMITH-PETERSEN, Hohlmeißelzange.....	238
Schwingmesser, BALLENGER.....	436	Septumzange, GRAIG.....	426	SMITH-PETERSEN, Osteotom.....	261
SCOVILLE, Haken.....	196	Septumzange, LUC.....	426	SMITHWICK, Anlegezange.....	326
SCOVILLE, Laminektomiespreizer.....	196	Septumzange, MIDDLETON-JANSEN.....	430	SMITHWICK, Nervhaken.....	329
SCOVILLE, Nervwurzelhaken.....	329/1, 330	Septumzange, RUBIN.....	428	SNELLEN, Muskelpinzette.....	393
SCOVILLE, scharfer Löffel.....	253	Sequesterzange.....	249	SNELLEN, Starschlinge.....	378
SCOVILLE-HAVERFIELD, Laminektomiespreizer.....	196	SERPENTINE-GRASPER, Fasszange.....	593	SOMER, Uterus-Fasszange.....	585
SCUDDER, Darmklemme.....	541	Set Doppel-Sägeblatt.....	230/7	Sonde.....	199, 335
SEBILLEAU, Rasporator.....	275	Set Filtertüten.....	231/1	Sonde, BRODIE.....	199
SEDLLOT, Rasporator.....	274, 275	Set Sägeblatt.....	230/5, 230/6	Sonde, COLLIN.....	586
Segment-sägeblatt.....	230/5, 230/15	SEUTIN, Verbandschere.....	69/2	Sonde, DOYEN.....	199
SEGOND, Hysterektomie-klemme.....	125	SEXTON, Ohrmesser.....	408	Sonde, FISH.....	199
SEGOND, Myomesser.....	594	Seziermesser, VIRCHOW.....	48	Sonde, HARMS.....	381
SEGOND-LANDAU, Hysterektomie-klemme.....	125	SHAMBAUGH, Häkchen.....	419	Sonde, JACOBSON.....	335
Sehnenfassinstrument, BRAND.....	293	SHAPLEIGH, Ohrschlinge.....	410	Sonde, LOCKHART-MUMMERY.....	200
Sehnenfassinstrument, CAROLL.....	293	SHEA, Mikro-Ohrschere.....	413	Sonde, MARTIN.....	586
Sehnenfassinstrument, KLEINERT-KUTZ.....	294	SHEEHAN, Osteotom.....	441	Sonde, NELATON.....	199
Sehnenfasspinzette, LARSEN.....	292	SHEEHAN, Septummeißel.....	441	Sonde, PRATT.....	563
Sehnenfasszange.....	293	SHEETS, Augenkanüle.....	394/2	Sonde, SIMS.....	586
Sehnenfasszange, JACKSON.....	292	Sichelmesser, HADEO.....	435	Sonde, STACKE.....	199
Sehnenführer, BUNELL.....	294	Sichelmesser, Tracheotomie.....	475	Sonde, VALLEIX.....	586
Sehnenhalte-zange, STEINMANN.....	292	Siebkorb, Endoskope u. Lichtleiterkabel.....	623	Sonde, WATSON-CHEYNE.....	199
Sehenschäler, BRAND.....	294	SIEBOLD, gynäkologische Schere.....	62	Sonde, WORST.....	381

Sondenspitzen, NABATOFF	201	SPURLING, Laminektomiezange	340	STILLE-LUER, Hohlmeisselzange	239
Spannarm, flexibel, LEYLA	368/3	Sputumbecher	621/1	STILLE-RUSKIN, Hohlmeisselzange	239
Spannplatte	49	St. CLAIR-THOMSON, Ringmesser	450	STILLE-SHERMAN, Handbohrapparat	298
Spannschlüssel	313	St. MARKS, Wundhaken	165	Stimmgabel	403, 404
Spatel	203, 530/1, 612/1	St. MARKS-PELVIS, Haken	165	Stimmgabel, HARTMANN	403
Spatel, KOCHER	552	St. MARTIN, Nahtpinzette	392	Stimmgabel, LUCAE	404
Spatel, LEGUEU	552	STACKE, Ohrsonde	199	Stimmgabel, RYDEL-SEIFFERT	404
Spatel, ROBB	530/1	STAMM, Knochensplitterzange	241	Stirnhöhlerdilator, RITTER-HALLE	433
SPATULA AND PACKER	612	Standard, chirurgische Schere	51	Stirnlampe, CLAR	22
Spekula, BARR	559	STANDARD (NELSON) Trokar	204	Stirnspiegel, ZIEGLER	21
Spekula, BODENHAMMER	559	Standgefäß	620	STOCKMANN, Penisklamme	553/1
Spekula, BREISKY	577	Stanze, Aorta	528	STONE, Schließklamme	545
Spekula, COLLIN	570	Stanze, CITELLI	430	STONE-WATT, Darmklamme	545
Spekula, CUSCO	570, 571	Stanze, COLCLOUGH	344/1	STONE-WATT, Klemmschloss	545
Spekula, CZERNY	559	Stanze, FERRIS-SMITH-KERRISON	344, 344/2	Stössel	258, 259
Spekula, DELEE	574	Stanze, HAJEK-KOFLER	429, 431	Stössel, CASPAR	258
Spekula, DOYEN	574	Stanze, KERRISON	428	STRABISMUS, Schere	58
Spekula, FRIEDMANN	577	Stanze, OSTROEM	430	Strabismuspinzette, BONACCOLTO	385
Spekula, GRAVE	570	Stanze, Zirkular	432	Strabismuspinzette, DASTOOR	386
Spekula, HILL-FERGUSON	560	Stariöffel, DAVIEL	377	Strabismuspinzette, JAMESON	385
Spekula, JACKSON	573	Stariöffel, GRAEFE	377	Strabismuspinzette, McCULLOUGH	385
Spekula, JOLL (FRIEDMANN)	577	Stariöffel, KNAPP	378	STRANDELL-STILLE, Wundhaken	157
Spekula, KALLMORGEN	573	Starmesser, DEUTSCHMANN	371	STRASSBURGER, Pinzette	89
Spekula, KOGAN	577	Starmesser, GRAEFE	371	STRATTE, Nadelhalter	212
Spekula, KRISTELLER	572	starrer Haltearm, LEYLA	368/1	STRAUSS, Penisklamme	553/1
Spekula, LANDAU	577	Starschlinge, ARLT	378	STRUEMPEL, Fremdkörperzangchen	412
Spekula, MATHIEU	560	Starschlinge, SNELLEN	378	STRULLY, neuro-chirurgische Schere	65
Spekula, O'SULLIVAN-O'CONNOR	576	Starschlinge, WEBER	378	STRUYCKEN, Nasenzange	427
Spekula, PEDERSON	570	Starschlinge, WILDER	378	SUBRAMANIAN, Kinder-Gefäßsklamme	521
Spekula, PRATT	559	Stativ	188	SUBRAMANIAN-MINIATURE, Kinder-Gefäßsklamme	521
Spekula, SAWYER	560	Staubbeutel	231/1	Supercutschere	71
Spekula, SCHERBAK	575	Staubbinde, ESMARCH	296	Supercutschere, BABY-METZENBAUM	71
Spekula, SCHULZE-BERGMANN	560	Staubsauger	231	Supercutschere, FREEMAN	74
Spekula, SEMM	571	STAUDE-MOORE, Hakenzange	582	Supercutschere, GORNEY	73
Spekula, SIMS	559, 573	Stechbecken	621/1	Supercutschere, IRIS	72
Spekula, TRÉLAT	571	STEINMANN, Knochenzange	307, 308	Supercutschere, KAYE	73
Spekula, VU-MORE	569, 570	STEINMANN, Sehenhaltezange	292	Supercutschere, KILNER	72
SPENCER, Fadenschere	66	STELLBRINK, Hohlmeisselzange	234	Supercutschere, LISTER	72
SPENCER-WELLS, Arterienklamme	109	sterile Ersatzlinge	50	Supercutschere, MAYO	71
Sperrer, ALAN-PARKES	561	sterile Skalpell-Klingen	42	Supercutschere, MAYO-STILLE	71
Sperrer, DAVIS-BOYLE	455	Sterilisierkästen	616, 618	Supercutschere, METZENBAUM	71
Sperrer, DINGMANN	456	Sterilisierklammer, BUNT	227, 624	Supercutschere, REES	73
Sperrer, KILNER-DOUGHTY	456	Sterilisierklammer, MAYO	227, 624	Supercutschere, REYNOLDS	72
Sperrer, Mammaria	487/1	Sterilisiersiebtschale	622	Supercutschere, STEVENS	72
SPINAL, scharfer Löffel	253	Sterilisierzange	227	Supercutschere, WAGNER	72
Spinalhaken, TAYLOR	291	Sterilisierzange, CHEATLE	227	SWEET, Anlegezange	326
SPINA-NASALIS, Wundhaken	461	Sterilisierzange, ROGGE	227	SYSTRUNK, chirurgische Schere	66
Spiralbohrer	302	Sterilisierzange, UNIVERSAL	227		
Spitze, YANKAUER Saugrohr	27	STERNBERG, Wangenhalter	453	T	
Splitterpinzette	91	Sternummeissel, LEBSCHKE	267, 480	TABB, Messer	418
Splitterpinzette, CARMALT	91	Sternunschere, SCHUMACHER	481	Tablett	620
Splitterpinzette, FEILCHENFELD	91	Sternusperrer, Mammaria	487/1	TAKAHASHI, Nasenzange	427
Splitterpinzette, HUNTER	91	Stethoskop, ANESTOPHON	23	Tamponstopfer, LUNIATSCHEK	465
Splitterzange, ARCHER	92	Stethoskop, DUPLEX	23	Tamponzange, BOZEMANN	138
Splitterzange, PEET	92	Stethoskop, PINARD	23	Tamponzange, BOZEMANN-DOUGLAS	138
Splitterzange, STIEGLITZ	92	STEVENS, Irispinzette	383	Tangentialklamme, DeBAKEY	502
Splitterzange, VIRTUS (RALK)	92	STEVENS, Linsenhalter	375	Tangentialklamme, DeBAKEY-SATINSKY	502
SPRATT, scharfer Löffel	251	STEVENS, Nadelhalter	214	Tangentialklamme, SATINSKY	502
Spreizer, ALAN-PARKS	561	STEVENS, Sehnenschere	58	TARNIER, Geburtszange	604
Spreizer, BENSON	544	STEVENS, Supercutschere	72	TARNIER, Kranioclast	607
Spreizer, Lateral	569	STEVENSON, Lidsperrer	371	Taschenbesteck	226
Spreizer, LEGUEU	553	STIEGLITZ, Splitterzange	92	TAYLOR, chirurgische Pinzette	87
Spreizer, MILLIN	552	STILLE, Arterienklamme	122	TAYLOR, Haken	196
Spreizer, SMITH	463/5	STILLE, Flachmeissel	260	TAYLOR, Perkussionshammer	24
Spreizer, SMITH-BUIE	561	STILLE, Gipschere	229	TAYLOR, Spinalhaken	291
Spreizer, THOMSON-WALKER	552	STILLE, Handbohrapparat	298	TC chirurgische Schere fein, REYNOLDS	54
Spreizzange, SMITH	463	STILLE, Hohlmeissel	260	TC chirurgische Schere, STANDARD	51
Spritze	407	STILLE, Osteotom	260	TC Nasenraspel, FOMON	445
Spritze gefüllt mit Fett	230/18	STILLE, Pinzette	81, 81/1	TC Pinzette, anatomisch	81
Spülkanüle, BISHOP-HARMON	394/1	STILLE, Rippenschere	480	TC Pinzette, chirurgisch	81/1
Spülkanüle, EICKEN (KILLIAN)	433	STILLE-BARRAYA, Gefäßpinzette	88	TC Pinzette, CUSHING	83
Spülkanüle, KILLIAN	433, 433/1	STILLE-HORSLEY, Knochensplitterzange	242	TC Pinzette, GILLIES	86
Spülkanüle, SIMCOE	394/2	STILLE-LISTON, Knochensplitterzange	242	TC Pinzette, SEMKEN	86

TC Pinzette, WAGENSTEIN	89	Tonsillenscherer, PRINCE	59	TUFFIER, Gewebefasszange	110
TC Schere, FREEMAN	74	Tonsillenschnürer, BRUENINGS	468	TUFFIER, Rippensperrer	487
TC Schere, GORNEY	73	Tonsillenschnürer, EVES	468	TUFFIER, Wundhaken	147
TC Schere, KAYE	73	Tonsillenschnürer, TYDING	469	Tumorfasszange, LANDOLT	341
TC Schere, PECK-JOSEPH	74	Tonsillenspritze	470	Tumorpinzette, YASARGIL	97
TC Schere, REES	73	Tonsillenzange, BALLENGER	467	Tupferzange, BRYANT	137
TEALE, Hakenzange	583	Tonsillenzange, BLOHMKE	467	Tupferzange, CHERON	137
TEBBETS, Wundhaken	197	Tonsillenzange, NEGUS	467	Tupferzange, COLLIN	137
Teleskop-Bohrdrahtstütze	299	Tonsillenzange, SAWTELL	467	Tupferzange, FOERSTER	136
TERSON, Kapselpinzette	391	Tonsillenzange, SCHNIDT	467	Tupferzange, LISTER (SINUS)	137
TESSIER, Haken	463/3	Tonsillenzange, TYDING	468	Tupferzange, PELKMANN	137
TESSIER, Mobilisierhaken	463/3	Tonsillenzange, WHITE	467	Tupferzange, RAMPLEY	136
T-Handgriff, HUDSON	300	Tonsillotom, SLUDER-BALLENGER	470	TURNBULL, Nagelzange	609
T-Handgriff, Schnellkupplung	300, 301	Tonsillotom, TYDING	469	TURREL, Mastdarmbiopsiezange	567
THIERRY, Geburtszange	603	TOOK, Hornhautmesser	373	TYDING, Tonsillenschnürer	469
THOMAS, Uteruskürlette	599	Tourniquet, RUMEL-BELMONT	528	TYDING, Tonsillenzange	468
THOMAS-GAYLOR, Biopsiezange	588	TOWNLEY, Schieblehre	26	TYDING, Tonsillotom	469
THOMS-ALLIS, Darmfasszange	538	TOWNSEND, Uterus-Biopsiezange	591		
THOMSON-WALKER, Blasenwundspitzer	552	TOYNBEE, Ohrspekula	399	U	
Thoraxsperrer, MERCEDES	489	Trachealhaken, BOSE	477	USA MOD., Nabelschnur-Schere	64
THOREK, Gallenblasenschere	65/2	Trachealdilatator, LABORDE	476	UCKERMANN, Watterträger	203
THUDICHUM, Nasenspekula	421	Trachealdilatator, TROUSSEAU	476	Uhmacher Pinzette	90
TIECK-HALLE, Nasenspekula	423	Trachealdilatator, TROUSSEAU-BABY	476	ULRICH, Knochenhaltezange	248
Tiefen-Messinstrument	594	Trachealhaken, ITERSON	477	ULRICH, Kornzange	135
Tiefensägeblatt	230/6, 230/16	Trachealhaken, JACKSON	476	ULTA-LIGHT, Pinzette, atrauma	95
TILLEY, Ohrzangchen	411	Trachealhaken, NEWS	477	UNI I, Diagnostik-Besteck	13
TISCHLER-DOWN, Uterus-Biopsiezange	591	Trachealkanüle, CHEVALIER-JACKSON	479	UNI III, Diagnostik-Besteck	15
TISCHLER-KEVORKIAN, Uterus-Biopsiezange	592	Trachealkanüle, LUER	479	UNIVERSAL, Drahtschere	67
TISCHLER-MORGAN, Uterus-Biopsiezange	590, 591	Trachealkanüle, WAGENER-MOSHER	477	UNIVERSAL, Endoskophalterung	188
TISCHLER-UP, Uterus-Biopsiezange	591	Trachealwundspitzer, BOSE	476	UNIVERSAL, Pulverbläser	405
Titan-Arterienklemme, CRILE	107	Trachompinzette, KNAPP-LUER	393	UNIVERSAL, Sterilisationszange	227
Titan-Arterienklemme, KELLY	106	Tränenkanaldilatator, CASTROVIEJO	381	UNIVERSAL, Trokar	204
Titan-Bulldogklemme	102	Tränenkanaldilatator, WILDER	381	UNIVERSAL, Verbandsschere	70
Titan-Pinzette, DeBAKEY	99	Tränenkanaldilatator, ZIEGLER	381	Universalgriff, HUBER	472
TOBOLD, Watterträger	203	Tränenkanalsonde, BOWMAN	381	Universelle Wundhakenhalterung f. Armsystem	188
TOBOLD, Zungendrucker	453	Tränensackdissektor, LANG	378	UNNA, Komedonenquetscher	608
TOENNIS, Arterienklemme	117	Tränensackhäkchen, KNAPP	375	Unterbindungsnadel	218
TOENNIS, Dura-Dissektor	332	Tränensackhäkchen, ROLLET	375	Unterbindungsnadel, COOPER	219
TOENNIS-ADSON, Schere	65	TRAUERS, Wundspitzer	172	Unterbindungsnadel, DESCHAMPS	218
TOHUKU, Tuchklemme	132	TRELAT, Scheidenspekula	571	Unterbindungsnadel, KRONECKER	219
Tonometer, SCHIOETZ	394/2	Trepine, KEYES	608	Unterbindungsnadel, NELSON	219
Tonsillennadel, CLAUUS	466	TROELTSCH, Nasenpinzette	424	Unterbindungsnadel, SCHMIEDEN-DICK	219
Tonsillennadel, CLAUUS-EICKEN	466	TROELTSCH, Ohrpinzette	410, 424	Unterkieferhaken, HARGIS	463, 463/6
Tonsillennadel, DUPUY-WEISS	466	TROEMNER, Perkussionshammer	24	Urethrotom, OTIS	553
Tonsillennadel, NAGER	466	Trokar, COAKLEY	204	USA-ARMY, Wundhaken	141
Tonsillendissektor, HURD	465	Trokar, DOUGLAS	204	USA, anatomische Pinzette	81
Tonsillendissektor, LOPEZ-REINKE	465	Trokar, LICHTWITZ	204	USA Mod. Nabelschnurschere	64
Tonsillendissektor, YANKAUER	465	Trokar, NELSON	205	USA Modell, Verbindungskabel	633
Tonsillendraht	468	Trokar, OCHSNER	205	Uterusdilatator, GOODELL	581
Tonsillenelevator, CARPENTER	465	Trokar, SINOSKOPIE	205	Uterusdilatator, HANK	580
Tonsillenelevator, HENKE	465	Trokar, STANDARD (NELSON)	204	Uterusdilatator, PRATT	580
Tonsillenfasszange, MARSCHIK	468	Trokar, UNIVERSAL	204	Uterusdilatator, SIMS	581
Tonsillenfasszange, ABRAHAM	468	TROUSSEAU, Trachealdilatator	476	Uterusdilatator, WYLIE	581
Tonsillenfasszange, BALLENGER	467	TROUSSEAU-BABY, Trachealdilatator	476	Uteruspolyenzange, DOYEN	585
Tonsillenfasszange, BLOHMKE	467	TROUTMAN, Irispinzette	384	Uteruspolyenzange, KELLY	585
Tonsillenfasszange, COLVER	467	TROUTMAN, Muskelpinzette	389	Uteruspolyenzange, NOTO	585
Tonsillenfasszange, MARSCHIK	468	TROUTMAN-CHRIS, Klängenbrecher	45	Uterus-Biopsiezange, ALEXANDER	589
Tonsillenfasszange, NEGUS	467	Tubenkatheter, SCHULTZE	596	Uterus-Biopsiezange, BABY-TISCHLER	592
Tonsillenfasszange, SAWELL	467	Tuchklemme	133	Uterus-Biopsiezange, BURKE	590
Tonsillenfasszange, SCHNIDT	467	Tuchklemme, BACKHAUS	132	Uterus-Biopsiezange, BURKE-BABY	590
Tonsillenfasszange, TYDING	468	Tuchklemme, BACKHAUS-CLIP	132	Uterus-Biopsiezange, EPPENDORFER	590
Tonsillenfasszange, WHITE	467	Tuchklemme, BALL AND SOCKET	133	Uterus-Biopsiezange, KEVORKIAN	589, 591
Tonsillennmesser, ABRAHAM	466	Tuchklemme, BERNHARD	133	Uterus-Biopsiezange, KEVORKIAN-PACIFIC	592
Tonsillennmesser, BRUENINGS	466	Tuchklemme, DOYEN	133	Uterus-Biopsiezange, MAXI GRASPER	593
Tonsillennmesser, CANFIELD	466	Tuchklemme, JONES	132	Uterus-Biopsiezange, MINI-TOWNSEND-DOWN	591
Tonsillennmesser, CARPENTER	465	Tuchklemme, JONES-CLIP	132	Uterus-Biopsiezange, MINI-TOWNSEND-UP	591
Tonsillennmesser, DOUGLAS	466	Tuchklemme, LANE	133	Uterus-Biopsiezange, SCHUMACHER	589
Tonsillennmesser, FISHER	466	Tuchklemme, LORNA	133	Uterus-Biopsiezange, TISCHLER-DOWN	591
Tonsillennadel	470	Tuchklemme, MOYNIHAN	133	Uterus-Biopsiezange, TISCHLER-KEVORKIAN	592
Tonsillenscherer	59	Tuchklemme, PEERS	132	Uterus-Biopsiezange, TISCHLER-MORGEN	590, 591
Tonsillenscherer, BOETTCHER	59	Tuchklemme, ROEDER	132	Uterus-Biopsiezange, TISCHLER-UP	591
Tonsillenscherer, DEAN	59	Tuchklemme, SCHAEDEL	132	Uterus-Biopsiezange, TOWNSEND	591
Tonsillenscherer, GOOD	59	Tuchklemme, TOHOKU	132	Uterus-Biopsiezange, WITTNER	589

Uterus-Depressor, BRAUN.....	586	WAGENER-MOSHER, Trachealkanüle.....	477	WOLFF, Gipsabreisszange.....	233
Uterus-Depressor, SIMS.....	586	WAGENSTEEN, Gefäßspinzette.....	89	WOODSON, Dura-Dissektor.....	333
Uterus-Dilatator, GOODELL.....	581	WAGNER, Laminektomiezange.....	343	WORST, Sonde.....	381
Uterus-Dilatator, HANK.....	580	WAGNER, SCHERE.....	67	WRIGLEY, Geburtszange.....	602
Uterus-Dilatator, HEGAR.....	578, 579	WAGNER, Supercutschere.....	72	WULLSTEIN, Messer.....	418
Uterus-Dilatator, PRATT.....	580	WALDMANN, Episotomie-Schere.....	64	WULLSTEIN, Mikro-Löffelzangchen.....	416
Uterus-Dilatator, SIMS.....	581	WALSHAM, Septumrichtzange.....	449	WULLSTEIN, Mikro-Ohrzangchen.....	416
Uterus-Dilatator, WYLIE.....	581	WALTHER, Dilator-Katheter.....	555	WULLSTEIN, Sauggriff.....	338
Uterus-Fasszange, COLLIN.....	585	WALTON, Fingerringssäge.....	297	WULLSTEIN, Wundspreizer.....	171
Uterus-Fasszange, DARTIGUES.....	585	WALTON, Fremdkörperhohlmeißel.....	374	Wundhaken.....	463/3
Uterus-Fasszange, SOMER.....	585	WALTON, Komedonenquetscher.....	608	Wundhaken, ALM.....	168
Uterus-Kürette, BLAKE.....	595	Wangenhalter.....	453, 451	Wundhaken, ANDERSON.....	198
Uterus-Kürette, BUMM.....	597, 598	Wangenhalter, CAWOOD-MINNESOTA.....	451	Wundhaken, AUFRANC-COBRA.....	289
Uterus-Kürette, RECAMIER.....	597, 598	Wangenhalter, STERNBERG.....	453	Wundhaken, BREAST.....	198
Uterus-Kürette, SIMS.....	597, 598	WANGENSTEEN, Nadelhalter.....	210	Wundhaken, BRUNNER.....	167
Uterus-Kürette, THOMAS.....	599	WARTENBERG, Nervrädchen.....	25	Wundhaken, COLLIN.....	139
Uterus-Löffel, GOURDET.....	599	WATSON, Dermatoma.....	50	Wundhaken, COLLIN-HARTMANN.....	141
Uterus-Löffel, SCHRÖDER.....	595	WATSON-CHEYNE, Elevator.....	283	Wundhaken, COOLEY.....	148
Uterus-Löffel, SIMON.....	594	WATSON-CHEYNE, Sonde.....	199	Wundhaken, CORONAL.....	198
Uterus-Sonde, COLLIN.....	586	WATSON-WILLIAMS, Nasenzange.....	428	Wundhaken, CORYLLOS.....	166
Uterus-Sonde, MARTIN.....	586	Wattedose.....	621	Wundhaken, CRILE.....	140
Uterus-Sonde, SIMS.....	586	Watteträger, FARRELL.....	203	Wundhaken, CUSHING.....	151-153
Uterus-Sonde, VALLEIX.....	586	Watteträger, JOBSON-HORNE.....	203	Wundhaken, CZERNY.....	141
Uterus-Zange, GREEN-ARMYTAGE.....	605	Watteträger, HADEO.....	203	Wundhaken, DAVIDSON.....	166
		Watteträger, TOBOLD.....	203	Wundhaken, DEEVER.....	145, 146
V		Watteträger, UCKERMANN.....	203	Wundhaken, DEEVER-GRIP.....	146
VALLEIX, Uterus-Sonde.....	586	WALLICH, Abortuslöffel.....	607	Wundhaken, DESMARRÉS.....	151
Valve, CASPAR, Cervicalspreizer.....	179, 180	WAUGH, chirurgische Pinzette.....	83	Wundhaken, DOYEN.....	163
Valve, CLOWARD, Cervicalspreizer.....	178/1 - 178/4	WEBER, Aortaklemme.....	501	Wundhaken, DOYEN-STILLE.....	167
Valve, Bauchdeckenhalter, BALFOUR.....	183	WEBER, Starschlinge.....	378	Wundhaken, FARABEUF.....	139
Valve, Bauchdeckenhalter, HORGAN.....	183	WEBSTER, Nadelhalter.....	208	Wundhaken, FERRIERA.....	197
Valve, Scheidenspekula, O'SULLIVA-O'CONNOR.....	576	Wechselpinzette, Blätter.....	179	Wundhaken, FINSEN.....	168
VAN BUREN, Dilatationsbougie.....	554	WECKER, Augenschere.....	75	Wundhaken, FREEMAN.....	198
VAN BUREN, Knochenhaltezange.....	249	WECKER, Irisspatel.....	378	Wundhaken, FRITSCH.....	163
VAN DOREN, Biopsiezange.....	588	WEEK, Lidsperrer.....	370	Wundhaken, GIL-VERNET.....	152
VANNAS, Augenschere.....	79	WEIL-BLAKESLEY, Nasenzange.....	426	Wundhaken, GOELET.....	141
VARADY, Varizeninstrument.....	202	WEITLANER, Wundspreizer.....	169	Wundhaken, GREEN.....	160
Varizeninstrument, VARADY.....	202	WEITLANER-WULLSTEIN, Wundspreizer.....	169	Wundhaken, HARGIS.....	463
Vaskotomieklammer.....	553/1	WELLER, Präparierschere.....	53/2	Wundhaken, HARRINGTON.....	147
Verbandschere.....	70	WELLS, Enukeationslöffel.....	378	Wundhaken, HARRINGTON-PEMBERTON.....	147
Verbandschere, BERGMANN.....	69/1	WERTHEIM, gynäkologische Schere.....	62	Wundhaken, HASSON.....	143
Verbandschere, BRUNS.....	70	WERTHEIM, Hysterektomieklammer.....	124, 128	Wundhaken, HEANEY.....	164
Verbandschere, ESMARCH.....	69/2	WERTHEIM, Hysterektomieschere.....	63	Wundhaken, HIBBS.....	164
Verbandschere, KNOWLES.....	70	WERTHEIM-CULLEN, Nierenstielklammer.....	125	Wundhaken, HÖSEL.....	167
Verbandschere, LISTER.....	69/1	WEST, Hohlmeißel.....	442/1	Wundhaken, HOFER.....	465
Verbandschere, LORENZ.....	70	WEST, Nasenmeißel.....	442/1	Wundhaken, HOLZHEIMER.....	168
Verbandschere, HADEO EXCENTER.....	69/2	WESTCOTT, Augenschere.....	75	Wundhaken, ISRAEL.....	162
Verbandschere, SEUTIN.....	69/2	WESTMACOTT, Nasentamponzange.....	424	Wundhaken, JANSEN.....	168
Verbandschere, SMITH US ARMY.....	69/1	WESTON, Rektalschnürer.....	566	Wundhaken, KELLY.....	164
Verbandschere, UNIVERSAL.....	70	WHEELER, Disziionsmesser.....	373	Wundhaken, KELLY-GRIP.....	142
Verbandstofftrommel, SCHIMMELBUSCH.....	622	WHEELER, Zyklodialysespatel.....	379	Wundhaken, KLAPP.....	150
Verbindungskabel.....	633	WHITE, Tonsillenzange.....	467	Wundhaken, KÖNIG.....	153
VERBRUGGE, Knochenhaltezange.....	245	WIEDER, Zungendrucker.....	452	Wundhaken, KOCHER.....	155, 159, 160, 163
VERBRUGGE-MÜLLER, Knochenhebel.....	287	WIENER, Antrumraspel.....	443	Wundhaken, KOCHER-LANGENBECK.....	159
VERESS, Insufflationskanüle.....	206	WIENER, Irishäcken.....	375	Wundhaken, KOERTE.....	162
Verlängerungsrohr, BRUENINGS.....	472	WIGMORE, Gipsmesser.....	229	Wundhaken, LAHEY.....	157
Verlängerungsstück.....	299	WILKSTROEM, Arterienklammer.....	117	Wundhaken, LANGENBECK.....	158, 159
Verstellbares Sägeblatt.....	230/7	WILDE, Polypenschnürer.....	411, 433/2	Wundhaken, LANGENBECK-GREEN.....	153
VIENNA, Führungshohlsonde.....	221/1	WILDE (TROELTSCH), Ohrpinzette.....	410	Wundhaken, LITTLE.....	157
VIRCHOW, Seziermesser.....	48	WILDER, Starschlinge.....	378	Wundhaken, LOVE.....	465
VIRTUS (RALZ), Splitterzange.....	92	WILDER, Tränenkanal-Dilatator.....	381	Wundhaken, LUER.....	140
VOLKMANN, Doppellöffel.....	257	WILLET-MARTEL, Fasszange.....	110	Wundhaken, MATHIEU.....	141
VOLKMANN, Knochenhaken.....	156	WILLIAMS, Darmfasszange.....	539	Wundhaken, MITTELDRORF.....	160
VOLKMANN, scharfer Löffel.....	251, 257	WILLIAMS, Lidsperrer.....	370	Wundhaken, MIKULICZ.....	163
VOLKMANN, Wundhaken.....	153, 154, 156	WILLIAMS, Schraubenzieher.....	323	Wundhaken, MEYERDING.....	177
VOLTOLINI, Nasenspekula.....	421	WILLIGER, Hammer.....	271	Wundhaken, MORRIS.....	164
Vorböhrer, KUENTSCHER.....	321	WILLIGER, Raspator.....	276	Wundhaken, MURPHY.....	156
VU-MORE, Scheidenspekula.....	569	WILLIGER, scharfer Löffel.....	255, 257	Wundhaken, NAGER.....	465
		Winkelmesser, MOELTGEN.....	25	Wundhaken, OBWEGESER.....	460, 461/1
W		WINTER, Abortuszange.....	606	Wundhaken, OLLIER.....	162
WACHENFELDT, Wundklammerpinzette.....	224	Wirbelkörperspreizer, CLOWARD.....	339	Wundhaken, PARKER.....	139
WADSWORTH-TODD, Cauter.....	378	Wirbelkörperspreizer, INGE.....	339	Wundhaken, RAGNELL.....	140
WAGENER, Häkchen.....	409	WITTNER, Uterus-Biopsiezange.....	589	Wundhaken, RAMUS.....	461

Wundhaken, RICHARDSON	142	YASARGIL, SAUGROHR	337/1	Zange, WITTNER	589
Wundhaken, RICHARDSON-GRIP	142	YASARGIL, Spannarmling	368/2	Zange, YEOMANN	567
Wundhaken, RICHARDSON-EASTMAN	142	YASARGIL, Tumorzange	97	ZAUFAL, Ohrhebel	409
Wundhaken, ROSE	140	YEOMAN, Mastdarm-Biopsiezange	566, 567	ZAUFAL-JANSEN, Hohlmeisselzange	238
Wundhaken, ROSS	148/1	YOUNG, Prostatahaken	550	ZAUFAL-JANSEN, Ohrhebel	409
Wundhaken, ROUX	139	YOUNG, Zungenzange	453	ZEIGLER, Lidsperrer	371
Wundhaken, ROUX-BABY	140	YOUNG-BOOMERANG, Nadel	220	ZENKER, Arterienklemme	118
Wundhaken, ROUX-Mini	140			ZENKER, Wundhaken	161
Wundhaken, SAUERBRUCH	164, 166	Z		Zerlegbare Stanze, FERRIS-SMITH-KERRISON	344/2
Wundhaken, SENN-GREEN	153	Zahnfleischschere, GOLDMAN-FOX	67	ZEIGLER, Disziionsmesser	373
Wundhaken, SENN-MILLER	143	Zahnfleischschere, LA GRANGE	69, 72	ZEIGLER, Irismesser	372
Wundhaken, SIMON	164	Zahnfleischschere, LOCKLIN	69	ZEIGLER, Stirnspiegel	21
Wundhaken, SPINA-NASALIS	461	Zahnfleischschere, QUINBY	67	ZEIGLER, Tränenkanal-Dilatator	381
Wundhaken, St. MARKS	165	Zahnpinzette, LONDON-COLLEGE	93	ZIELKE, Hohlmeissel	264
Wundhaken, STRANDELL-STILLE	157	Zahnpinzette, MERIAM	93	Zirkular-Stanze	432
Wundhaken, TEBBETTS	197	Zange, ADAIR	582	ZÖLLNER, Saugrohr	337/1
Wundhaken, TUFFIER	147	Zange, ALEXANDER	589	Zubehör f. Autopsiesäge	230/1 - 230/9
Wundhaken, US-ARMY/PARKER-LANGENBECK	141	Zange, ASCH	449	Zubehör f. oszillierende Gipszange	230/11, 230/13
Wundhaken, VOLKMANN	153, 154, 156	Zange, BABY-TISCHLER	592	Zubehör f. Staubsauger u. Anlage	231/1
Wundhaken, YANCOSKIE	198	Zange, BARRETT	582	Zughaken, KIRSCHNER	313
Wundhaken, ZENKER	161	Zange, BLAKE	530/2	Zughebel, BARTON	603/2
Wundhakenhalterung	188	Zange, BRAUN	582	Zughebel, BILL	604
Wundklammern, MICHEL	224	Zange, BURKE	590	Zughebel, LUIKART-BILL	604
Wundklammerpinzette, HEGENBARTH	224	Zange, CHEVALIER-JACKSON	473	Zugseil, NABATOFF	201
Wundklammerpinzette, MICHEL	224	Zange, COLLIN	585	Zungendrucker, ANDREW	452
Wundklammerpinzette, WACHENFELDT	224	Zange, CZERNY	584	Zungendrucker, DAVIS-BOYLE	455
Wundklammerzange, CHILDE	224	Zange, DARTIGUES	585	Zungendrucker, DINGMANN	456
Wundklammerzange, COLLIN	224	Zange, DESJARDINS	530/2	Zungendrucker, HARTMANN	452
Wundklammerzange, MICHEL	224	Zange, DOYEN	585	Zungendrucker, KILNER-DOUGHTY	456
Wundklammerzange, RICHTER-HEATH	224	Zange, DUPLAY	582	Zungendrucker, MORITZ-SCHMIDT	452
Wundlöffel, ARRUGA	378	Zange, EPPENDORFER	590	Zungendrucker, TOBOLD	453
Wundnahtbesteck	225, 226	Zange, FAURE	588	Zungendrucker, WIEDER	452
Wundsperrer, ALM	168	Zange, GAUSS	605	Zungenspatel	451
Wundsperrer, CLOWARD	178/1 - 178/4	Zange, GREEN-ARMYTAGE	605	Zungenspatel, BRUENINGS	451
Wundsperrer, FINSEN	168	Zange, HEIMING	536	Zungenspatel, BUCHWALD	451
Wundsperrer, GELPI	189/2	Zange, HEYWOOD-SMITH	567	Zungenspatel, DOUGHTY	458
Wundsperrer, HOLZHEIMER	168	Zange, HULKA	583	Zungenspatel, FRENZEL	451
Wundsperrer, JACKSON-BURROWS	189/2	Zange, IOWA	584	Zungenspatel, KROENIG	451
Wundsperrer, JANSEN	168	Zange, JACOBS	583	Zungenspatel, MAYO	451
Wundsperrer, RIGBY	189/2	Zange, JARCHO	583	Zungenspatel, MORITZ-SCHMIDT	452
Wundspreizer, ADSON	172 - 174	Zange, JURASZ	471	Zungenspatel, RING	455
Wundspreizer, ADSON-BABY	173	Zange, KELLY	585	Zungenspatel, RUSSEL-DAVIS	458
Wundspreizer, ANDERSON-ADSON	172	Zange, KEVORKIAN	589, 592	Zungenzange, COLLIN	453
Wundspreizer, BECKMANN	176	Zange, KEVORKIAN-PACIFIC	592	Zungenzange, YOUNG	453
Wundspreizer, BECKMANN-ADSON	175	Zange, MATHIEU	553/1	Zwischenknochen-Messer	44
Wundspreizer, BECKMANN-EATON	176	Zange, MAYO-BLAKE	530/2	Zwischenstück, SCHULTZE Salpingograph	596
Wundspreizer, BOSE	476	Zange, MAXI GRASPER	593	Zyklodialysespatel, BANGERTER	379
Wundspreizer, CASPAR	180	Zange, MIXTER	530/2	Zyklodialysespatel, CASTROVIEJO	379
Wundspreizer, DARLING	178	Zange, MUSEUX	583	Zyklodialysespatel, ELSCHNIG	379
Wundspreizer, HENLEY	170	Zange, NOTO	585	Zyklodialysespatel, HIRSCHMANN	379
Wundspreizer, MARTIN	175/1	Zange, POZZI-PALMER	582	Zyklodialysespatel, WHEELER	379
Wundspreizer, MAYO-ADAMS	171	Zange, PRATT	584		
Wundspreizer, MEYERDING	180	Zange, RANDALL	535		
Wundspreizer, MOLLISON	171	Zange, HADEO	474		
Wundspreizer, NORFOLK/NORWICH	172	Zange, ROWE	459		
Wundspreizer, PERKINS	168	Zange, SAENGER	606		
Wundspreizer, PLESTER	171	Zange, SCHRÖDER	584		
Wundspreizer, SCALP-CONTOUR	169	Zange, SCHRÖDER (POZZI)	582		
Wundspreizer, TRAVERS	172	Zange, SCHUBERT	588		
Wundspreizer, WEITLANER	169	Zange, SCHUMACHER	588, 589		
Wundspreizer, WEITLANER-WULLSTEIN	169	Zange, SERPENTINE GRASPER	593		
Wundspreizer, WULLSTEIN	169, 171	Zange, SKENE	582		
WYLIE, Aortaklemme	501/1	Zange, SMITH	463		
WYLIE, Uterus-Dilatator	581	Zange, SOMER	585		
		Zange, TEALE	583		
Y		Zange, THOMAS-GAYLOR	588		
YANCOSKIE, Wundhaken	198	Zange, TISCHLER-KEVORKIAN	592		
YANKAUER, Saugrohr	27	Zange, TISCHLER-MORGAN	590		
YANKAUER, Tonsillen-Dissektor	465	Zange, TOWNSEND	591		
YASARGIL, Gefäßclip	349 - 356	Zange, TURREL	567		
YASARGIL, Galeahaken	330	Zange, Van DOREN	588		
YASARGIL, Hirnspatelhalter	368	Zange, WALSHAM	449		
YASARGIL, Ohrspekulahalter	368/2	Zange, WINTER	606		

abdominal- a. intestinal spatula KÜMMEL	143/4, 144	amputation saw SATTERLEE	296	atraumatic forceps COOLEY	99
abdominal retractor KIRSCHNER	187, 187/1	Anal retractor SMITH-BUIE	561	atraumatic tissue forceps DEBAKEY	99
abdominal retractors BABY GOSSET	181	anastomosis clamp BECK	516	AUFFRANC retractor	289
abdominal retractors BALFOUR	182	anastomosis clamp BECK	520	AUFRIEHT nose hook	447
abdominal retractors BALFOUR Baby	182	anastomosis clamp COOLEY	519, 520 - 520/4	AUFRIEHT nose rasp	443
abdominal retractors BALFOUR-US	184	anastomosis clamp COOLEY-DERRA	519	Auricle clamp HARKEN	503
abdominal retractors CHARNLEY	289	anastomosis clamp DE MARTEL-WOLFSON	546	autopsy knife	48
abdominal retractors COLLIN	190	anastomosis clamp DEBAKEY	505	autopsy saw and accessories	230 - 230/9
abdominal retractors COLLIN-LOKTTITE	191	anastomosis clamp LAMBERT-KAY	505	AUVARD vaginal specula	576
abdominal retractors DENIS-BROWNE	185	anatomic tissue forceps BROPHY	84	awl	304
abdominal retractors DOYEN	189/1	anatomic tissue forceps	81	awl HARGIS	463
abdominal retractors FRAZIER	181	anatomic tissue forceps ADSON	81/2	Awl OBWEGESER	463
abdominal retractors KIRSCHNER	185, 187	anatomic tissue forceps ADSON Micro	81/2	awl PERTHES	304
abdominal retractors RICARD	191	anatomic tissue forceps BONNEY	88	AXENFELD chalazio curette	377
abdominal retractors RIGBY	189/2	anatomic tissue forceps CUSHING	83	AYER chalazio tissue forceps	393
abdominal retractors ROCHARD	186	anatomic tissue forceps CUSHING-TAYLOR	87		
abdominal retractors KADER	143/3	anatomic tissue forceps DUEHRSEN	84	B	
abdominal spatula KOERTE	143/3	anatomic tissue forceps GERALD	86	BABCOCK intestinal grasping forceps	539
abdominal spatula Leriche	143/4	anatomic tissue forceps McINDOE	85	BABINSKI percussion mallet	24
ABLI ophthalmologic scissors	58	anatomic tissue forceps POTTS-SMITH	81	BABY BURKE biopsy forceps	590
ABRAHAM tonsil forceps	468	anatomic tissue forceps SEMKEN	86	BABY GOSSET abdominal retractor	181
ABRAHAM tonsil knives	466	anatomic tissue forceps TAYLOR	87	BABY METZENBAUM supercut scissors	71
accessories for autopsy saw	231/3	anatomic tissue forceps TC	81	BABY TISCHLER rongeur	592
ADAIR tenaculum forceps	582	anatomic tissue forceps type USA	81	BABY WEBSTER needle holder	208
adenoid curette BARNHILL	450	anatomic tissue forceps STILLIE	81	BABY YANKAUER suction tube	27
adenoid curette BECKMANN	450	ANDERSON ADSON retractors	172	BABY-KOCHER intestinal clamp	540
adenoid curette St. CLAIR-THOMSON	450	ANDERSON retractor	198	BABY-OLSEN-HEGAR needle holder	212
Adenotom LA FORCE	450	ANDREW tongue depressor	452	BABYPHON Sphygmomanometer	10
ADLERKREUTZ vascular tissue forceps	84	ANDREW-PYNCHON suction tube	28	Back holder Abdominal retractor system	192, 193, 194, 195
ADSON retractors	173	ANESTOPHON	23	BACKHAUS towel clamp	132
ADSON anatomic tissue forceps	81/2	aneurysm clamp DEBAKEY-BAHNSON	506	BACKHAUS-clip	132
ADSON anatomic tissue forceps	81/2	aneurysm clip applicator forceps	357 - 360	BAILEY rib spreader	489/1
ADSON BABY hemostatic clamp	113	aneurysm vascular clip YASARGIL	349 - 356	BAILEY-BABY rib spreader	489/1
ADSON bone rongeur	236	anoscope HIRSCHMANN	562	BAILEY-GIBBON rib spreader	489/1
ADSON dura hook	328	anoscope IVES-FANSLER	562	BAINBRIDGE hemostatic clamp	120
ADSON hemostatic clamp	112	Antrum curette COAKLEY	449	BAINBRIDGE vascular clamp	495/1, 495/2
ADSON holding clamp	298	Antrum rasp LEWIS	443	BAKES gall duct dilator	532
ADSON hypophyseal forceps	334	ANTRUM-curette	435	BALFOUR abdominal retractors	182
ADSON MICRO anatomic tissue forceps	81/2	ANVIL nail forceps	613	BALFOUR BABY abdominal retractors	182
ADSON MICRO surgical tissue forceps	81/2	aorta clamp WEBER	501	BALFOUR hook	193
ADSON needle holder	211	aorta punch	528	BALFOUR-US abdominal retractors	184
ADSON raspatories	282	antrum clamp WYLIE	501/1, 501/2	BALL AND SOCKET towel clamp	133
ADSON retractors	172, 173, 174	appendix clamp ALLEN	544	ball electrode MONOPOLAR	628, 629
ADSON suction tube	337	appendix clamp KLEINSCHMIDT	544	BALLENGER knives	436
ADSON surgical tissue forceps	81/2	applier forceps aneurysm clip	357 - 360	BALLENGER septum elevator	439
ADSON-BROWN tissue forceps	82	applier forceps BIEMER	361, 366	BALLENGER tonsil forceps	467
ADSON-DEBAKEY atraumatic forceps	81/2	applier forceps JOHNS-HOPKINS	104	bandage scissors	70
air blower	405	applier forceps MC KENZIE	326	bandage scissors BERGMANN	69/1
air blower POLITZER	406	applier forceps MEHDORN	362	bandage scissors BRUNS	70
AIR INJECTION eye cannula	394	applier forceps SMITHWICK	326	bandage scissors ESMARCH	69/2
air pump	295	applier forceps SWEET	326	bandage scissors KNOWLES	70
ALAN-PARKS rectal specula	561	applying forceps RANEY	327	bandage scissors LISTER	69/1
ALDERDYCE elevator	282	Approximator BIEMER	366	bandage scissors LORENZ	70
ALEXANDER biopsy forceps	589	Approximator BIEMER-MÜLLER	363	bandage scissors HADEO EXCENTER	69/2
ALEXANDER chisels	259	Approximator MÜLLER	364	bandage scissors SEUTIN	69/2
ALEXANDER raspatories	276	ARCHER splinterforceps	92	bandage scissors SMITH US army	69/1
ALLEN appendix intestinal clamp	544	ARLT cataract loop	378	bandage scissors UNIVERSAL	70
ALLIS intestinal grasping forceps	537	armsystem	188	BANE-HARTMANN bone rongeur	237
ALLIS-ADAIR intestinal grasping forceps	537	ARRUGA capsular forceps	391	BANGERTER cyclodialysis spatula	379
ALLIS-BABY intestinal grasping forceps	537	ARRUGA extraction hook	375	BARACANI interchangeable tips	472
ALLISON lung spatula	489/2	ARRUGA eye specula	370	BARANY air blower	405
ALM retractor	168	ARRUGA needle holder	214	BARBARA hook	419
ALVIS foreign body curette	374	ARRUGA wound curette	378	BARBARA needle	419
amnioscope	601	ASCH septum straightening forceps	449	BARKAN goniotomy knives	373
amniotome BEACHAM	586	atrauma bulldog clamp	100	BARNHILL adenoid curette	450
amputation knives CATLIN	44	Atrauma bulldog clamp	100, 102	BARON scution tube	336
amputation knives LANGENBECK	44	atrauma clamp DEBAKEY	100	BARR rectal-specula	559
amputation knives LISTON	44	atrauma clamp DEBAKEY	103	BARRAQUER cilia forceps	395
amputation knives HADEO	44	atrauma clamp GLOVER	100	BARRAQUER eye scissors	75
amputation saw BIER	296	atrauma neonatal clamp	523	BARRAQUER eye specula	370
amputation saw CHARRIERE	296	atrauma-bulldog clamp GLOVER	103	BARRAQUER fixation forceps	390
		atraumatic forceps ADSON-DEBAKEY	81/2	BARRAQUER knives	373

BARRAQUER needle holder.....	217	Bipolar-tissue forceps bajonett	632	bone holding forceps FARABEUF	243
BARRAQUER needle holder	216, 217	BIRCHER-GANSKE bone holding forceps.....	246	bone holding forceps FARABEUF-LAMBOTTE.....	243
BARRAQUER-KATZIN iris tissue forceps.....	384	BIRKETT hemostatic clamp	116	bone holding forceps FERGUSSON	243
BARRET hook forceps	582	BISHOP-HarmAN iris tissue forceps	386	bone holding forceps KERN	244
BARTON obstetrical forceps.....	603/2	BISHOP-HarmAN irrigation cannula	394/1	bone holding forceps LAMBOTTE	244
battery handle for cold light	33	bladder retractors LEGUE	553	bone holding forceps LANE	244
battery handle for warm light	32	bladder retractors MILLIN	552	bone holding forceps LANGENBECK	243
BAUMGARTNER needle holder	208	bladder retractors THOMSON-WALKER	552	bone holding forceps LEWIN	246
BEACHAM amniotome.....	586	bladder retractorsJUDD-MASSON	552	bone holding forceps MEYER	248
BECHERT Nucleus Rotator	379	bladder spatula KOCHER	552	bone holding forceps HADEO.....	246, 247
BECK anastomosis clamp.....	520	bladder spatula LEGUEU	552	bone holding forceps REILL	248
BECK vascular clamp.....	516	bladder spreader MILLIN	553	bone holding forceps SEMB	243
BECKER cystotome	375	blade breaker CASTROVIEJO.....	45	bone holding forceps ULRICH	248
BECKMANN adenoid curette.....	450	blade breaker HADEO	45	bone holding forceps VAN BUREN	249
BECKMANN retractors.....	176	blade breaker TROUTMAN-CHRIS	45	bone holding forceps VERBRUGGE	245
BECKMANN-ADSON retractors.....	175	blade ejecting forceps	179	bone hook VOLKMANN	156
BECKMANN-EATON retractors.....	176	blade remover	42	bone levers.....	284, 288
bed pan	621/1	blade scalpel	42	bone levers BENNETT	283
BEEBEE crown scissors.....	68	blades razor.....	45	bone levers BLOUNT	288
BEER cilia forceps.....	395	BLAKE gall stone forceps	530/2	bone levers HOHMANN	284
BEESON plaster retractor	232	BLAKE uterine curette	595	bone levers HOHMANN	285
BELLUCCI micro ear scissors.....	413	BLOHMKE tonsil forceps	467	bone levers HOHMANN Mini	286
BELLUCCI micro scissors.....	417	blood vessel clamp DIETRICH	510	bone levers KOENIG	284
bender LANE	322/1	blood vessel clamp MORRIS-DEBAKEY	506	bone levers LANGE-HOHMANN	286
bender LANE	325	BLOUNT bone levers	288, 289	bone levers SMILLIE	291
BENGOLEA hemostatic clamp	112	blower KABIERSKE.....	405	bone levers VERBRUGGE-MÜLLER	287
BENNETT bone levers	283	BLUMENTHAL bone rongeur	236	bone plate holding forceps LANE	325
BENSAUDE proctoscope.....	565	BODENmallet rectal specula	559	bone rasp	294
BENSON pylorus retractor	544	BOEHLER extension bow	312	bone rasp PUTTI	294
BERENS dissection knives	372	BOERMA obstetrical forceps	604	bone rongeur rLEKSELL-STILLE	240
BERGMANN bandage scissors	69/1	BOETTCHEr tonsil scissors	205	bone rongeur ADSON	236
BERGMANN mallet	272	BÖHLER bone cutting forceps	241	bone rongeur BANE-HARTMANN	237
BERKE muscle forceps.....	389	BÖHLER bone rongeur	238	bone rongeur BEYER	237, 238
BERLINER percussion mallet.....	24	BOIES elevator	277	bone rongeur BLUMENTHAL	236
BERNHARD towel clamp	133	BONACCOLTO strabismus forceps	385	bone rongeur BOEHLER	238
BERRY wire forceps.....	319	bone curettes	255, 256	bone rongeur CLEVELAND	235
BETHUNE rib scissors	481	bone curettes BRUNS	251, 254	bone rongeur ECHLIN	240
BEYER bone rongeur	237, 238	bone curettes BUSHE	256	bone rongeur FRIEDMAN-MICRO	234
BIEMER applier forceps.....	361, 366	bone curettes DAUBENSPECK	255	bone rongeur FRIEDMAN-MINI	234
BIEMER approximator	366	bone curettes HALLE	253	bone rongeur FRYKHOLM	240
BIEMER vascular clip	361	bone curettes JACOBSON.....	257	bone rongeur JANSEN	237
BIEMER-MÜLLER approximator	363	bone curettes JANSEN	257	bone rongeur KLEINERT-KUTZ	237
BIER amputation saw	296	bone curettes LEMPERT	256	bone rongeur LEMPERT	237
BILLEAU ear loop	409	bone curettes MARTINI	257	bone rongeur LUER.....	236
biopsy curette HEANY	587	bone curettes SCHEDE	251	bone rongeur MARQUARD	239
biopsy curette KEVORKIAN	587	bone curettes SCOVILLE	253	bone rongeur MAYFIELD	238
biopsy curette NOVAK	587	bone curettes SPINAL	253	bone rongeur MEAD	235
biopsy curette RANDALL	587	bone curettes SPRATT	251	bone rongeur OLIVECRONA	237
biopsy curette type MÜNCHEN	587	bone curettes VOLKMANN	251, 257	bone rongeur RUskin	239
biopsy forceps ALEXANDER.....	589	bone curettes WILLIGER	255, 257	bone rongeur SAUERBRUCH	240
biopsy forceps BABY BURKE	590	bone cutting forceps BOEHLER	241	bone rongeur SCAGLIETTI	240
biopsy forceps BURKE	590	bone cutting forceps COTTLE-KAZANJIAN	241	bone rongeur SEMB	240
biopsy forceps EPPENDORFER.....	590	bone cutting forceps LISTON	241	bone rongeur SMITH-PETERSEN	238
biopsy forceps FAURE	588	bone cutting forceps McINDOE	241	bone rongeur STELLBRINK	234
biopsy forceps KEVORKIAN	589	bone cutting forceps RUskin.....	241	bone rongeur STILLE-LUER	239
biopsy forceps KEVORKIAN	591	bone cutting forceps SEMB	242	bone rongeur STILLE-RUskin	239
biopsy forceps KEVORKIAN-PACIFIC	592	bone cutting forceps STILLE-HORSLEY	242	bone rongeur ZAUFAL-JANSEN	238
biopsy forceps MAXI GRASPER	593	bone cutting forceps STILLE-LISTON.....	242	bone wire soft	314
biopsy forceps SCHUBERT	588	bone hand drills BUNELL	299	BONNI iris tissue forceps	387
biopsy forceps SCHUMACHER	588, 589	bone hand drills HUDSON	299	BONNEY anatomic tissue forceps	88
biopsy forceps THOMAS-GAYLOR.....	588	bone hand drills KIRSCHNER.....	299	BONNEY surgical tissue forceps	88
biopsy forceps TISCHLER-DOWN	591	bone hand drills MOORE	298	BOSE trachea hook	476, 477
biopsy forceps TISCHLER-KEVORKIAN	592	bone hand drills RALK	300	BOUCHERON ear specula.....	399
biopsy forceps TISCHLER-MORGAN	591	bone hand drillsSTILLE	298	BOWMAN dissection needle gerade.....	374
biopsy forceps TOWNSEND MINI	591	bone hand drillsSTILLE-SHERMAN	298	BOWMAN eye specula.....	370
biopsy forceps TOWNSEND TISCHLER MINI	591	bone holding clamp FELDHEIM	249	BOWMAN lachrymal probes	381
biopsy forceps VAN DOREN	588	bone holding clamp GERSTER	250	Box PETRI	620
biopsy forceps WITTNER	589	bone holding clamp LAMBERT-LOWMAN	249	BOYNTON needle holder	214
biopsy forcepsTISCHLER-MORGAN	590	bone holding clamp LOWMAN	249	BOZEMANN dressing forceps	138
biopsy needle MENGHINI	206	bone holding clamp LOWMAN-HOGLUND	249	BOZEMANN needle holder	211
biopsy-/suction curette	600	bone holding forceps	249	BOZEMANN-DOUGLAS dressing forceps.....	138
bipolar cable.....	633	bone holding forceps BIRCHER-GANSKE	246	brain knives	48
bipolar tissue forceps.....	630, 631	bone holding forceps DINGMANN	246	brain spatula CUSHING	336

brain spatula CUSHING	369	capsular forceps CASTROVIEJO	391	chisels COTLE	440
brain spatula DAVIS	337	capsular forceps ELSCHNIG	391	chisels HIBBS	265
brain spatula HEIFETZ	369	capsular forceps FUCHS	391	chisels HOKE	265
brain spatula OLIVECRONA	336	capsular forceps GILL-ARRUGA	390	chisels Killian	442/1
BRAND tendon grasping instrument	293	capsular forceps HESS	391	chisels LAMBOTTE	261
BRAND tendon passing instrument	294	capsular forceps KALT	391	chisels LEXER	263
BRAUN cranoplast	607	capsular forceps SCHWEIGGER	391	chisels MINI-LAMBOTTE	262
BRAUN decapitating hook	607	capsular forceps TERSON	391	chisels NOVOTEX	264
BRAUN hook forceps	582	capsular grasping forceps MILLIN	551	chisels OBWEGESER	463
BRAUN uterine-Depressor	586	cardiovascular clamps	526	chisels SMITH-PETERSEN	261
BRAUN-STADLER episotomy scissors	64	CarmALT splinter tissue forceps	91	chisels STILLE	260
BREAST retractor	198	CAROLL tendon grasping instrument	293	cilia forceps BARRAQUER	395
BREISKY vaginal specula	577	Carotid shunt clamp JAVID	511	cilia forceps BEER	395
BRIDGE hemostatic clamp	116	CARPENTER tonsil knives	465	cilia forceps DOUGLAS	395
BRISTOW bone levers	290	CARTILAGE knives	47	cilia forceps GRADLE	395
BRODIE probes	199	CASPAR hemostats	258	cilia forceps LITTAUER	395
Broncho forceps CHEVALIER-JACK	473	CASPAR retractors	179, 180	cilia forceps HADEO	395
bronchus clamp	126	CASTANEDA Neonatal vascular clamp	527	CINELLI septum chisels	441
bronchus clamp FINOCCHIETTO	490	CASTROVIEJO	79, 381	circular rongeur	432
bronchus clamp HARRINGTON	490	CASTROVIEJO bladeBREAKER	45	CIRCUMCISIONS instrument	556
bronchus clamp LEES	504	CASTROVIEJO capsular forceps	391	CITELLI rongeur	430
bronchus clamp PRICE-THOMAS	490	CASTROVIEJO cyclodialysis spatula	379	clamp socket	189
bronchus clamp SEMB	491	CASTROVIEJO discision knives	372	clamp Vasektomie	553/2
BROPHY anatomic tissue forceps	84	CASTROVIEJO eye specula	371	CLAR HEAD LIGHTS	22
BROPHY surgical tissue forceps	84	CASTROVIEJO fixation forceps	390	CLARK eye specula	370
BROWN needle holder	209	CASTROVIEJO hornyskincissors	79	CLAUS tonsil needle	466
BROWN tissue forceps	83	CASTROVIEJO Measurance circle	380	CLAYMAN	376
BRUENINGS ear specula	401	CASTROVIEJO needle holder	215	Clayman hook	376
BRUENINGS interchangeable tips	472	CASTROVIEJO tissue forceps	392	cleaning pistol	626
BRUENINGS septum forceps	425	CASTROVIEJO-MICRO needle holder	215	CLEVELAND bone rongeur	235
BRUENINGS tongue depressors	451	CASTROVIEJO-STANDARD needle holder	216	clip forceps CHILDE	224
BRUENINGS tonsil knives	466	cataract curette DAVIEL	377	clip forceps COLLIN	224
BRUENINGS tonsil snare	468	cataract curette GRAEFE	377	clip forceps MICHEL	224
BRUNETTI chisels	268	cataract curette KNAPP	378	clip forcepsRICHTER-Heath	224
BRÜNING-S-LUCAS chisels	260	cataract knives DEUTSCHMANN	371	clip MICHEL	224
BRUNNER guideprobes	221/1	cataract knives GRAEFE	371	clip tissue forceps HEGENBARTH	224
BRUNNER intestinal clamp	543	cataract loop ARLT	378	clip tissue forceps MICHEL	224
BRUNNER retractor	167	cataract loop SNELLEN	378	clip tissue forceps WACHENFELDT	224
BRUNNER rib scissors	481	cataract loop WEBER	378	clip-applier forceps	523, 524
BRUNS bandage scissors	70	cataract loop WILDER	378	CLOWARD lamina spreader	339
BRUNS bone curettes	251, 254	CATHER INTRODUCING FORCEPS MAGILL	28	CLOWARD laminectomy retractor forceps	342
brush dispenser	611	catheter forceps COOLEY	510	CLOWARD retractors	178/1, 178/2, 178/3, 178/4
BRYANT dressing forceps	137	catheter guide GUYON	554	COAKLEY ANTRUM curette	449
BUCHWALD tongue depressors	451	catheter WALTHER	555	COAKLEY trocar	204
BUCK ear curette	407	CATLIN amputation knives	44	COBB curette	252
BUCK foreign body lever	412	cauter WADSWORTH-TODD	378	COBB gouges	262
BUCK percussion mallet	24	cervica retractor CLOWARD	178/1, 178/2, 178/3, 178/4	COBB raspatories	280
BUCK-GRAMCKO bone levers	285	cervical traction tong CRUTCHFIELD	327	COLCLOUGH intervertebral disc rongeur	344/1
BUIE rectal suction tube	566	chalazio curette AXENFELD	377	COLD LIGHT GUIDE HOLLINGER	37
BULLDOG clamp atrauma	100	chalazio curette HEBRA	377	COLD LIGHT GUIDE JACKSON	37
BULLDOG clamp DEBAKEY	100, 103	chalazio curette MEYHOEFER	377	COLD LIGHTClamp for Amnioskope	601
bulldog clamp DIETRICH	101	chalazio tissue forceps AYER	393	COLLER-CRILE hemostatic clamp	106
bulldog clamp GLOVER	103	chalazio tissue forceps DESMARRÉS	393	COLLIER needle holder	208
bulldog clamp JOHNS-HOPKINS	104	chalazio tissue forceps LAMBERT	393	COLLIER pelvimeter	605
BULOW-GUNAR-HEY tubing clamp	130	CHAPUT tissue grasping forceps	110	COLLIN abdominal retractor	190
BUMM uterine curette	597	CHARNLEY abdominal retractor	289	COLLIN clip forceps	224
BUNELL bone hand drills	299	CHARRIERE amputation saw	296	COLLIN dressing forceps	137
BUNELL tendon guide	294	CHEATLE sterilization forceps	227	COLLIN DYNAMOMETER	25
BUNELL tendon passing instr.	292	cheek retractorSTERNBERG	453	COLLIN intestinal grasping forceps	539
BUNGE scoop	378	cheekSTEIN needle holder	210	COLLIN LOKTITE abdominalDE	191
BUNT sterilization clamp	227	CHELSEA-EATON proctoscope	563	COLLIN mallet	270
BURCH fixation forceps	373	CHERON dressing forceps	137	COLLIN navelstringclamp	605
BURKE biopsy forceps	590	CHERRY laminectomy retractor	488	COLLIN pelvimeter	605
BUSCH episotomy scissors	64	CHEST SUPPORT KLEINSASSER	36	COLLIN retractor	139
BUSHE bone curette	256	CHEVALIER-JACKSON	473	COLLIN scalpel-handle	40
		CHEVALIER-JACKSON trachea cannula	479	COLLIN tissue grasping forceps	110
		CHILDE clip forceps	224	COLLIN tongue forceps	453
		children atrauma vascular clamp	526	COLLIN uterine-grasping forceps	585
		chisel NEIVERT-ANDERSON	442	COLLIN uterine-probes	586
		chisels	259, 264	COLLIN vaginal specula	570
		chisels ALEXANDER	259	COLLIN-DUVAL grasping PINZE	85
		chisels blade	266	COLLIN-HARTMANN retractor	141
		chisels BRUNETTI	268	Columella tissue forceps COTLE	448
C					
cable bipolar	633				
caliper TOWNLEY	26				
CANFIELD tonsil knives	466				
CAPLAN nose forceps	428				
capsula scissors RESANO	53/2				
capsular forceps ARRUGA	391				

COLVER tonsil forceps.....	467	cup medicine.....	621	DEBAKEY vascular scissors.....	61
comedone extractor SAALFELD.....	608	cup sputum.....	621/1	DEBAKEY vascular scissors TC.....	60
comedone extractor SCHAMBERG.....	608	curette Antrum.....	435	DEBAKEY-BAHNSON aneurysm clamp.....	506
comedone extractor UNNA.....	608	curette Cobb.....	252	DEBAKEY-DIETHRICH MINI BULLDOG clamp.....	101
comedone extractor WALTON.....	608	curette FAULKNER.....	449	DEBAKEY-MIXTER vascular clamp.....	499/2
compression bandage.....	296	curette forceps.....	416	DEBAKEY-MOSQUITO hemostatic clamp.....	509
CONE curette.....	280	curette HOUSE.....	420	DEBAKEY-PEAN atrauma clamp.....	513
CONE head punch.....	331	CUSCO vaginal specula.....	570	DEBAKEY-RANKIN atrauma clamp.....	512
CONE raspatories.....	280	Cushing (Taylor) tissue forceps TC.....	87	DEBAKEY-RUMEL vascular clamp.....	499
CONNIN-AMSLER marker.....	380	CUSHING anatomic tissue forceps.....	83	Decapitating hook BRAUN.....	607
CONVERSE nose hook.....	448	CUSHING brain spatula.....	336, 369	DECKER rongeur.....	341
CONVERSE septum knives.....	435	CUSHING drill.....	299	DEJERINE percussion mallet.....	24
COOPER ligaturee clamp.....	519, 520 - 520/4	CUSHING laminectomy retractor forceps.....	340	Delee retractor.....	574
COOLEY atraumatic tissue forceps.....	99	CUSHING nerve ENhook.....	328	DEMEL wire guide needle.....	315
COOLEY catheter forceps.....	510	CUSHING retractor.....	152	DEMEL wire instrument.....	315
COOLEY retractor.....	148	CUSHING retractor.....	153	DENHART mouth gags.....	454
COOLEY rib spreader.....	487	CUSHING retractor.....	151, 152, 153	DENIS-BROWNE abdominal retractors.....	185
COOLEY vascular clamp.....	518, 522	CUSHING surgical tissue forceps.....	83	derf ruler.....	594
COOLEY-DERRA anastomosis clamp.....	519	CUSHING tissue forceps.....	87	DERF needle holder.....	208
COOLEY-NEONATAL rib spreader.....	485	CUSHING-TAYLOR anatomic tissue forceps.....	87	Dermatom HUMBY.....	50
COOLY suction tube.....	28	CUZZI ovum curette.....	606	Dermatom SILVER.....	50
COOPER ligaturee needle.....	219	cyclodialysis spatula BANGERTER.....	379	Dermatome SCHINK.....	49
CORDES interchangeable tips.....	472	cyclodialysis spatula CASTROVIEJO.....	379	dermatome blade.....	49
corneal dissector GREEN.....	374	cyclodialysis spatula ELSCHNIG.....	379	DESCHAMPS ligaturee needle.....	218
corneal dissector PATON.....	373	cyclodialysis spatula WHEELER.....	379	DESJARDINS gall stone curette.....	534
corneal scarifier ELSCHNIG.....	373	Cystotom BECKER.....	375	DESJARDINS gall stone forceps.....	530/2
corneal scarifier GILL.....	373	Cystotom GRAEFE.....	375	DESJARDINS gall stone probe.....	531
corneal scarifier TOOK.....	373	CZERNY hook forceps.....	584	DESJARDINS hemostatic clamp.....	121
CORONAL BROW retractor.....	198	CZERNY rectal-specula.....	559	DESMARRES chalazoid tissue forceps.....	393
CORWIN-HEGAR wire forceps.....	319	CZERNY retractor.....	141	DESMARRES retractor.....	151
CORYLLOS retractor.....	166	D		DEUTSCHMANN cataract knives.....	371
CORYLLOS rib scissors.....	480	DALE vascular clamp.....	494, 495	DEVILBISS head forceps.....	332
COS micro ear forceps.....	414	DANDY hemostatic clamp.....	109	Diagnostic set ECO "C".....	16
COTTLE columella tissue forceps.....	448	DANDY nerve hook.....	328	Diagnostic set ECO "T".....	16
COTTLE fixation forceps.....	410	DARDIK multi purpose clamp.....	509/1	Diagnostic set RI-MINI.....	17
COTTLE mallet.....	273	DARLING retractors.....	178	Diagnostic set UNI III.....	15
COTTLE nose hook.....	447, 447/1	DARTIGUES uterine grasping forceps.....	585	DIFFENBACH vascular clamp.....	104
COTTLE nose scissors.....	59	DASTOOR strabismus forceps.....	386	DIETER micro ear forceps.....	414
COTTLE nose specula.....	423	DASTOOR suction tube.....	380	DIETRICH blood vessel clamp.....	510
COTTLE scissors.....	56	DAUBENSPECK bone currettes.....	255	DIETRICH MINI-bulldog clamp.....	101
COTTLE septum chisels.....	440	DAVIDSON(SCAPULA) retractor.....	166	DIETRICH vascular scissors.....	60
COTTLE septum elevator.....	439	DAVIEL cataract curette.....	377	dilation bougie DITTEL.....	554
COTTLE septum knives.....	435	DAVIS brain spatula.....	337	dilation bougie GUYON.....	554
COTTLE skin hook.....	447, 448	DAVIS dura dissector.....	379	dilation bougie VAN BUREN.....	554
COTTLE-JOSEPH septum.....	439	DAVIS foreign body needle.....	374	DINGMANN bone holding forceps.....	246
COTTLE-KAZANJIAN bone cutting forceps.....	241	DAVIS sterilization tissue forceps.....	227	DINGMANN mouth gag.....	456
COTTLE-NEIVERT.....	448	DAVIS-BOYLE.....	455	DINGMANN raspatories.....	463
cotton-applicator.....	203	DAVIS-BOYLE SPERRE.....	455	DINGMANN retractor.....	463
cotton-applicator FARRELL.....	203	DAVIS-MEYER mouth gag.....	457	DINGMANN spreader.....	456
cotton-applicator JOBSON-HORNE.....	203	DAY hook.....	409	DIPLOMAT Sphygmomanometer.....	5
cotton-applicator HADEO.....	203	DE BAKEY needle holder.....	210	discision knives BERENS.....	372
cotton-applicator TOBOLD.....	203	DE BAKEY vascular clamp.....	493-500, 502, 505-508, 512-517	discision knives CASTROVIEJO.....	372
cotton-applicator UCKERMANN.....	203	DE BAKEY vascular scissors.....	60, 61	discision knives JAEGER.....	372
COXETER METAL catheter.....	555	DE BAKEY vascular dilator.....	529	discision knives WHEELER.....	373
CRAFOOD-SELLORS hemostatic clamp.....	118	DE BOER rib spreader.....	486	discision knives ZIEGLER.....	373
CRAFOOD hemostatic clamp.....	118	DE LEE obstetrical forceps.....	602	discision needle.....	374
CRAFOOD lung scissors.....	65/2	DE MARTEL guide sleeve.....	330	discision needle BOWMAN.....	374
cranoplast BRAUN.....	607	DE MARTEL-WOLFSON.....	546	disimpaction forceps ROWE.....	459
cranoplast TARNIER.....	607	DEAN iris knives.....	372	dissecting scissors.....	52, 52/1, 53
CREGO elevator.....	282	DEAN tonsil scissors.....	59	dissecting scissors.....	53/2
CRILE hemostatic clamp.....	107	DEAVER dissecting scissors.....	52	dissecting scissors DEAVER.....	52
CRILE needle holder.....	213	DEAVER retractor.....	145	dissecting scissors JORGENSEN.....	53
CRILE nerve hook.....	328	DEAVER-GRIP retractor.....	146	dissecting scissors LEXER.....	53
CRILE retractor.....	140	DEBAKEY aortic clamp.....	505	dissecting scissors LEXER-BABY.....	53
CRILE-MURRAY needle holder.....	209	DeBakey atrauma bulldog clamp.....	100, 103	dissecting scissors LEXER-BABY TC.....	53
CRILE-RANKIN hemostatic clamp.....	107	DEBAKEY atrauma clamp.....	100	dissecting scissors MAYO.....	52/1
CRILE-WOOD needle holder.....	209	DEBAKEY atrauma clamp.....	103	dissecting scissors MAYO-NOBLE.....	52/1
CRITCHETT eye specula.....	370	DEBAKEY atraumatic tissue forceps.....	99	dissecting scissors MAYO-STILLE.....	52/1
crown scissors BEEBEE.....	68	DEBAKEY retractor.....	189/1	dissecting scissors METZENBAUM.....	53/1
CRUTCHFIELD head holder.....	327	DEBAKEY suction tube.....	28	dissecting scissors METZENBAUM FINO.....	53/1
CRUTCHFIELD cervical traction tong.....	327	DEBAKEY vascular clamp.....	493-500, 502, 505-508, 512-517	dissecting scissors METZENBAUM FINO TC.....	53/1
cuff for leg.....	295				
cuff for upper arm.....	295				

dissecting scissors METZENBAUM TC	53/1	dura scissors SCHMIEDEN-TAYLOR	65/1	ESMARCH bandage scissors	69/2
dissecting scissors PECK-JOSEPH	74	duraNTE grasping tissue forceps	88	ESMARCH plaster knives	233
dissecting scissors TOENNIS-ADSON	65	DUVAL grasping tissue forceps	85	ETHICON clip forceps	524
dissector FISCH	420	DUVAL intestinal grasping forceps	539	EVES tonsil snare	468
dissector GORNEY	277	Dynamometer COLLIN	25	EXACTA Sphygmomanometer	8
dissector PENFIELD	333			Exenteration curette BUNGE	378
DITTEL dilation bougie	554	E		extensions bows BOEHLER	312
DIX foreign body chisels	374	ear catheter HARTMANN	408	extensions bows KIRSCHNER	312
DIX foreign body instrument	380	ear curette BUCK	407	extensions bows KIRSCHNER US	312
double curette VOLKMANN	257	ear curette GROSS	409	extirpation chisels ROLLET	374
DOUGHTY tongue blade	458	ear forceps HARTMANN	411	extraction dissector LANG	378
DOUGLAS cilia forceps	395	ear forceps HEYMANN-KNIGHT	425	extraction hook ARRUGA	375
DOUGLAS tonsil knives	466	ear forceps JANSEN	424	extraction hook KNAPP	375
DOUGLAS trocar	204	ear forceps LITTAUER	411	extraction hook ROLLET	375
DOYEN abdominal retractor	189/1	ear forceps LUCAE	410	extractor KUENTSCHER	322
DOYEN gynecological scissors	63	ear forceps TILLEY	411	eye cannula MCINTYRE	394
DOYEN intestinal clamp	540	ear forceps TROELTSCH	424	eye cannula type AIR INJECTION	394
DOYEN myoma a screw	594	ear forceps WILDE (TROELTSCH)	410	eye cannula type SHEETS	394/2
DOYEN probes	199	ear knives POLITZER	408	eye magnet HADEO	395
DOYEN raspatories	278	ear knives SEXTON	408	eye scissors BARRAQUER	75
DOYEN retractor	163	ear lever ZAUFAL	409	eye scissors NOYES	75
DOYEN scissors	63	ear lever ZAUFAL-JANSEN	409	eye scissors VANNAS	79
DOYEN towel clamp	133	ear loop BILLEAU	409	eye scissors WECKER	75
DOYEN uterine polyp forceps	585	ear loop SHAPLEIGH	410	eye scissors WESTCOTT	75
DOYEN vaginal specula	574	ear probes STACKE	199	eye specula ARRUGA	370
DOYEN-BABY intestinal clamp	540	ear specula BOUCHERON	399	eye specula BARRAQUER	370
DOYEN-JANSEN(MOLT)	454	ear specula BRUENINGS	401	eye specula BOWMAN	370
DOYEN-JANSEN(MOLT) mouth gags	454	ear specula GRUBER	399	eye specula CASTROVIEJO	371
DOYEN-STILLE	167	ear specula HARTMANN	399	eye specula CLARK	370
dressing forceps BOZEMANN	138	ear specula POLITZER	399	eye specula CRITCHETT	370
dressing forceps BOZEMANN-DOUGLAS	138	ear specula RICHNAU-HOLMGREN	400	eye specula GRAEFE	370
dressing forceps BRYANT	137	ear specula SIEGLE	402	eye specula LANCASTER	371
dressing forceps CHERON	137	ear specula TOYNBEE	399	eye specula LISTER-BURCH	370
dressing forceps COLLIN	137	ear syringe REINER	406	eye specula MELLINGER	370
dressing forceps FOERSTER	136	ECHLIN bone rongeur	240	eye specula MELLINGER-AXENFELD	370
dressing forceps GROSS-MAIER	134	ECO "C" Diagnostic set	16	eye specula MUELLER	371
dressing forceps BOZEMANN-DOUGLAS	138	ECO "T" Diagnostic set	16	eye specula MURDOCK	370
dressing forceps MAIER	134	EICKEN (KILLIAN) irrigation cannula	433	eye specula PARK	371
dressing forceps PELKMANN	137	elevator ALDERDYCE	282	eye specula SMITH	370
dressing forceps RAMPLEY	136	elevator BOIES	277	eye specula WEEK	370
dressing forceps SIMS-MAIER	134	elevator CREGO	282	eye specula WILLIAMS	370
dressing forceps ULRICH	135	elevator DINGMANN	463, 463/3	eye specula ZIEGLER	371
dressing tissue forceps JACKSON	471	elevator FREER	434	eye specula STEVENSON	371
drill bits	302	elevator KEY	282	eye suction -/irrigation cannula	394
drill CUSHING	299	elevator LEMPERT	420		
drill ERRICO	299	elevator LUNIATSCHKEK	465	F	
drill MC KENZIE	299	elevator McDONALD	283	Face Lift scissors FREEMAN	74
drill wire	299	elevator MURPHY-LANE	283	Face Lift scissors GORNEY	73
drills	299	elevator SAYRE	281	Face Lift scissors KAYE	73
drillwire KIRSCHNER	306, 307	elevator WATSON-CHEYNE	283	Face Lift scissors REES	73
driver KUENTSCHER	321	ELLIOT obstetrical forceps	603	FANSLER proctoscope	564
drivers	321	ELLIS foreign body gouges	374	FARABEUF bone holding forceps	243
drums SCHIMMELBUSCH	622	ELSCHING capsular forceps	391	FARABEUF raspatoriesies	274
DUBOIS gynecological scissors	63	ELSCHING corneal scarifier	373	FARABEUF retractor	139
DUEHRSEN anatomic tissue forceps	84	ELSCHING cyclodialysis spatula	379	FARABEUF-COLLIN raspatoriesies	274
DUPLAY dressing forceps	134	ELSCHING fixation forceps	389	FARABEUF-LAMBOTTE bone holding forceps	243
DUPLAY hook forceps	582	EMMETT fistula hook	594	FARRELL cotton-applicator	203
DUPLEX stethoscope	23	ENDER nail STEINMANN	307	FARRIOR ear specula	400
DUPUY-WEISS tonsil knives	466	endoscop eassembly	188	FARRIOR ear specula	400
dura dissector	332	endoscope wire basket	623	FAULKNER curette	449
dura dissector DAVIS	332	Endospecula KOGAN	577	FAURE biopsy forceps	588
dura dissector FRAZIER	333	ENGEL plaster cast saw	229	FAURE peritoneum clamp	123
dura dissector HOEN	333	enterotomy scissors	66	FAVALORO vascular scissors	61
dura dissector HORSLEY	333	Entropium forceps SNELLEN	393	FEHLAND intestinal clamp	542
dura dissector MILLIGAN	332	enuclation curette WELLS	378	FEILCHENFELD tissue forceps	91
dura dissector OLIVECRONA	332	ENUCLEATION scissors	58	FELDHEIM bone holding clamp	249
dura dissector SACHS	332	epiglottis retractor FRAENKEL	471	FERGUSSON bone holding forceps	243
dura dissector TOENNIS	332	epiglottis retractor JACKSON	471	FERGUSSON clamp	109
dura dissector WOODSON	333	epiglottis retractor REICHERT	471	FERGUSSON FRAZIER suction tube	337
dura hook	335	episotomy scissors WALDMANN	64	FERGUSSON gall stone curette	533
dura hook ADSON	328	EPKER osteotome	464/2	FERGUSSON surgical scissors	66
dura hook JACOBSON	335	EPPENDORFER biopsy forceps	590	FERRIERA retractor	197
dura knives KOOS	335	ERICH wire pusher	461/2	FERRIS-SMITH laminectomy retractor forceps	343

FERRIS-SMITH surgical tissue forceps	85	FREER skin hook.....	448	graduated measure	620
FERRIS-SMITH-KERRISON rongeur	344, 344/2	FRENZEL nystagmus spectacles.....	20	GRAEFFE cataract curette	377
FICHOCHIETTO-BABY rib spreader	482	FRENZEL tongue depressors.....	451	GRAEFFE cataract knives	371
files nail	612/1	FRIEDMANN MINI bone rongeur	234	GRAEFFE cystotome.....	375
FINGER nail drill	297	FRIEDMANN specula	577	GRAEFFE discision knives	372
finger protector LANGENBECK.....	311	FRITSCH retractor	163	GRAEFFE discision knives	372
Finger ring saw HADEO.....	297	FRYKHOLM bone rongeur	240	GRAEFFE fixation forceps.....	389
Finger ring saw WALTON	297	FUCHS capsular forceps	391	GRAEFFE hook	148/2
Finger-Goniometer	25	FUCHSIG hemostatic clamp	113	GRAEFFE IRIS tissue forceps	382
Fingersaw LANGENBECK.....	296			Graefe scissors.....	56
FINOCCHIETTO bronchusclamp.....	490	G		GRAEFFE strabismus hook.....	375
FINOCCHIETTO rib spreader.....	482	Galeahook YASARGIL.....	330	GRAEFFE tissue forceps.....	83
FINOCCHIETTO Baby rib spreader	482	gall duct dilator BAKES.....	532	GRAFFFE eye specula	370
FINOCCHIETTO needle holder	211	gall stone curette DESJARDINS.....	534	GRAHAM nerve hook	328
FINOCCHIETTO rib spreader	484	gall stone curette FERGUSSON.....	533	grasping forceps.....	316
FINOCCHIETTO-BURFORD rib spreader	483	gall stone curette LUER-KOERTE.....	533	grasping forceps.....	415
FINSEN retractor	168	gall stone curette MAYO	534	grasping forceps LAHEY	479
FISCH dissector	420	gall stone curette MOOR	531	grasping forceps MARTEL	110
FISCH fine hook	335	gall stone forceps BLAKE	530/2	grasping forceps PRATT	110
FISCHER iris tissue forceps	384	gall stone forceps DESJARDINS	530/2	grasping forceps WILLET MARTEL.....	110
FISH probes	199	gall stone forceps MAYO-BLAKE	530/2	grasping tissue forceps COLLIN-DUVAL	85
FISHER tonsil knives.....	466	gall stone forceps MIXTER	530/2	grasping tissue forceps duraNTE	88
fistula hook EMMETT	594	gall stone probes DESJARDINS	531	grasping tissue forceps DUVAL	85
fistula probes PRATT.....	563	gall stone probes MAYO	534	grasping tissue forceps LERCHE	83
fistulaprobes LOCKHART-MUMMERY.....	200	gall stone probes MOYNIHAN	531	grasping tissue forceps RUSS MODELL	85
fixation forceps BARRAQUER.....	390	GALLAHER ANTRUM rasp.....	446	GRAVE vaginal specula	570
fixation forceps CASTROVIEJO	390	GASS hook	376	GRAY hemostatic clamp	121
fixation forceps Cottle	410	GAUSS scalp forceps	605	GREEN corneal dissector.....	374
fixation forceps ELSCHNIG	389	GELPI abdominal retractor	189/1, 189/2	GREEN fixation forceps.....	390
fixation forceps GRAEFE.....	389	GELPI hook	193	GREEN muscle hook	375
fixation forceps GREEN.....	390	GEMINI hemostatic clamp	115	GREEN retractor	160
fixation forceps LESTER	389	GERALD anatomic tissue forceps	86	GREEN-armYTAGE.....	605
Fixierforc BURCH.....	373	GERALD surgical tissue forceps	87	GREGOIRE intestinal forceps.....	538
Flat forceps	316, 317	GERSTER bone holding clamp	250	GREVEN micro ear forceps.....	414
FOERSTER dressing forceps	136	GERZOG mallet.....	270	GROSS ear curette.....	409
FOERSTER IRIS tissue forceps	383	GIERTZ-STILLE rib scissors	481	GROSS-MAIER dressing forceps.....	134
FOMON nose rasp	444	GIGLI saw	332	GRUBER ear specula	399
FOMON nose scissors	58	GILL corneal scarifier	373	guide driver.....	321
FOMON raspatories	277	GILL iris tissue forceps.....	384	guide needle REDON	207
FOMON Rhinoplastscissors	65/1	GILL-ARRUGA capsular forceps.....	390	GUILEN suction raspatories.....	433/1
FOMON septum chisels	441	GILL-HESS iris tissue forceps.....	384	gum scissors LA GRANGE.....	69
FOMON skin hook	447/1	GILLIES needle holder	212	gumscissors GOLDMAN-FOX	67
FOMON TC nose rasp	445	GILLIES skin hook	448	gumscissors LOCKLIN	69
FOREGGER laryngoscope	29, 31	GILLIES surgical tissue forceps	86	gumscissors QUINBY	67
foreign body chisels DIX	374	GIL-VERNET retractor	152	GUTHRIE skin hook	148/2
foreign body curette ALVIS	374	GLOVER atrauma clamp	100	GUYON catheter einguide.....	554
foreign body forceps HARTMANN	412	GLOVER bulldog clamp	103	GUYON dilation bougie.....	554
foreign body forceps HARTMANN-HOFFMANN	412	GLOVER vascular clamp	515	GUYON hemostatic clamp.....	122
foreign body forceps HARTMANN-WULLSTEIN	412	GLUCK rib scissors	480	GUYON kidney clamp	122
foreign body forceps MATHIEU	553/1	GOELET retractor	141	GUYTON-LUNDSSGAARD sclerotome.....	373
foreign body gouges ELLIS	374	GOLDMANN-FOX gum scissors	67	gynecological scissors DOYEN.....	63
foreign body gouges WALTON	374	GOMEL microsurgical tissue forceps.....	96	gynecological scissors DUBOIS	63
foreign body instr. DIX	380	GOMMEL micro scissors	80	gynecological scissors SIEBOLD	62
foreign body lever BUCK	412	goniometer for finger.....	25	gynecological scissors SIMS	62
foreign body lever QUIRE.....	412	goniometer MOELTGEN.....	25	gynecological scissors SIMS	62
foreign body needle.....	374	goniotomy knives BARKAN	373	gynecological scissors WERTHEIM	63
foreign body needle DAVIS	374	goniotomy knives SCHEIE	373		
foreign body needle FRANCIS	374	GOOD tonsil scissors	59	H	
foreign body needle LA FORCE.....	374	GOODELL uterine Dilatatator	581	HABERER intestinal spatula	143/3
foreign body needle LEVINSON	374	GORNEY dissector	277	haemorrhoid.forceps MCGIVNEY	568
FOX LUPUS curette	608	GORNEY FACE LIFT scissors	73	haemorrhoid.LigaturRUDD.....	568
FRAENKEL interchangeable tips.....	472	GOSSET abdominal retractor	181	haemorrhoidal clamp FERGUSSON	109
FRANCIS foreign body needle	374	gouges	264	haemorrhoidal forceps HEYWOOD-SMITH	567
FRAZIER abdominal retractor	181	gouges PARTSCH	259	Haemorrhoidal Ligatur MC GIVNEY	568
FRAZIER dura dissector.....	333	gouges COBB	262	HAGLUND-STILLE plaster retractor.....	232
FRAZIER punctum cannula	337	gouges HIBBS	265	HAIGHT rib spreader.....	487
FRAZIER skin hook	148/2	gouges LEXER MINI.....	263	HAJEK mallet	273
FREEMAN face lift scissors.....	74	gouges WEST	442/1	HAJEK septum chisels.....	442/1
FREEMAN retractor	198	gouges ZIELKE.....	264	HAJEK-BALLENGER elevator	439
FREER elevatorIUM	434	gougesSTILLE	260	HAJEK-KOFLER rongeur	429, 431
FREER septum chisels	439, 442	GOURDET uterine curette	599	HALLE bone curettes	253
FREER septum elevator	437	GRADLE cilia forceps	395	HALLE septum elevator.....	437
FREER septum knives	434	GRADLE ophthalmologic scissors	57	halogen lamp for laryngoscope.....	29
				HALSEY needle holder.....	208

HALSTED-MOSQUITO hemostatic clamp	105	hemostatic clamp JACOBSON	105	hook BARBARA	419
handle for chisels/chisels	266	hemostatic clamp JOHNS-HOPKINS	120	hook DAY	409
handle For chisels/OSTEO	266	hemostatic clamp KANTROWITZ	119	hook FISCH	335
handle scalpel	38, 39, 39/1, 39/2, 40, 41	hemostatic clamp KELLY	106	hook forceps BARRET	582
handle scalpel MINI	41	hemostatic clamp KELLY-RANKIN	106	hook forceps BRAUN	582
HANK uterine dilator	580	hemostatic clamp KOCHER	108	hook forceps CZERNY	584
HARGIS awl	463	hemostatic clamp LAHEY	120	hook forceps DUPLAY	582
HARGIS mandibular body retractor	463/6	hemostatic clamp LAWRENCE	119	hook forceps HULKA	583
HARGIS raspatory	463/2	hemostatic clamp LERICHE	111	hook forceps IOWA	584
HARKEN auricle clamp	503	hemostatic clamp LOVELACE	109	hook forceps JACOBS	583
HarmS lachrymal probes	381	hemostatic clamp LOWER	120	hook forceps JARCHO	583
HarmS probes	333	hemostatic clamp MAYO-GUYON	122	hook forceps MUSEUX	583
HARRINGTON bronchusclamp	490	hemostatic clamp MEEKER	119	hook forceps PRATT	584
HARRINGTON hook	193	hemostatic clamp Micro-HARTMANN	104	hook forceps Schröder	584
HARRINGTON -PEMBERTON retractor	147	hemostatic clamp MIXTER	119, 121	hook forceps SCHROEDER	583
HARRINGTON retractor	147	hemostatic clamp MIXTER-BABY	119	hook forceps SCHROEDER (POZZI)	582
HARTMANN ear catheter	408	hemostatic clamp MOYNIHAN	121	hook forceps SKENE	582
HARTMANN ear specula	399	hemostatic clamp O'SHAUGNESSY	120	hook forceps TEALE	583
HARTMANN foreign body forceps	412	hemostatic clamp OVERHOLT	114	hook forcepsSTAUDE-MOORE	582
HARTMANN foreign body lever	411	hemostatic clamp PEAN	108	hook GASS	376
HARTMANN hemostatic clamp	104	hemostatic clamp PEAN	110	hook GELPI	193
HARTMANN nose specula	422, 427	hemostatic clamp PENNINGTON	109	hook HARRINGTON	193
HARTMANN polyp forceps	424	hemostatic clamp PROVIDENCE-HOSPITAL	106	hook KELLY	193
HARTMANN tongue depressors	452	hemostatic clamp ROBERTS	117	hook KUGLEN	376
HARTMANN tuning forc	403	hemostatic clamp ROCHESTER-CarmALT	109	hook LUCAE	409
HARTMANN-HALLE nose specula	421	hemostatic clamp ROCHESTER-OCHSNER	108	hook McGEE	419
HARTMANN-HOFFMANN foreign body forceps	412	hemostatic clamp ROCHESTER-PEAN	108	hook SCOVILLE	196
HARTMANN-WULLSTEIN foreign body forceps	412	hemostatic clamp RUMEL	117	hook SINISKEY	376
HASSON retractor	143	hemostatic clamp SAROT	118	hook SMELLIE	605
HAUGH micro ear forceps	414	hemostatic clamp S-cvd MIXTER	116	hook WAGENER	409
HAYES rectum clamp	545	hemostatic clamp SPENCER-WELLS	109	hookSt.EVENS	375
head holder CRUTCHFIELD	327	hemostatic clamp STILLE	122	HOPKINS plaster knives	233
head mirror ZIEGLER	21	hemostatic clamp TOENNIS	117	HORIZON clip forceps	524
head punch CONE	331	hemostatic clamp WIKSTROEM	117	HORSLEY dura dissector	333
HEANEY hysterectomy clamp	126	hemostatic clamp ZENKER	118	HÖSEL retractor	167
HEANEY needle holder	210	hemostatic clampOVERHOLT-BABY	114	HOUSE curette	420
HEANY biopsy curette	587	hemostatic clampOVERHOLT-GEISSENDÖRFER	114	HOUSE suction tubeE	337/2
HEANY retractor	164	hemostatic clampOVERHOLT-MIXTER	115	HOWARTH septum elevator	438
HEANY-BALLENTINE hysterectomy clamp	127	hemostats	259	HUBER UNIVERSALhandle	472
hear light CLAR	22	HENKE tonsil-elevator	465	HUDSON bone hand drills	299
HEATH mallet	273	HENLEY retractors	170	HUDSON T-handle	300
HEATH suture scissors	66	HENNIG plaster retractor	232	HULKA hook forceps	583
HEBRA chalazio curette	377	HEPP-SCHIEDEL micro scissors	78	HUMBY DERMATOM	50
HEGAR uterine dilator	578, 579	HERCULES wire cutter	320/1 - 320/3	HUNTER splinter forceps	91
HEGENBARTH clip tissue forceps	224	HERRICK NIERENSTIELclamp	123	HURD tonsil elevator	465
HEIFETZ brain spatula	369	HESS capsular forceps	391	hypophyse curette	334
HEIMING kidney stone forceps	536	HESS iris tissue forceps	384	hypophyse tissue forceps ADSON	334
HEISS hemostatic clamp	112	HEYMANN septum forceps	425	hysterectomy clamp HEANEY	126
HEISTER mouth gags	454	HEYMANN nose scissors	58	hysterectomy clamp HEANY-BALLENTINE	127
hemostatic clamp ADSON	112	HEYMANN-KNIGHT ear forceps	425	hysterectomy clamp MAINGOT	123/1, 123/2
hemostatic clamp ADSON-BABY	113	HEYWOOD-SMITH haemorrhoidal forceps	567	hysterectomy clamp ROGERS	127
hemostatic clamp BAINBRIDGE	120	HIBBS chisels	265	hysterectomy clamp SEGOND	125
hemostatic clamp BENGOLEA	112	HIBBS gouges	265	hysterectomy clamp SEGON-LANDAU	125
hemostatic clamp BIRKETT	116	HIBBS retractor	164	hysterectomy clamp WERTHEIM	124
hemostatic clamp BRIDGE	116	HILL-FERGUSON rectal-specula	560	hysterectomy clamp WERTHEIM	128
hemostatic clamp COLLER-CRILE	106	HIRSCHMAN spatula	331	hysterectomy forceps WERTHEIM-CULLEN	125
hemostatic clamp CRAFOORD	118	HIRSCHMANN anoscope	562	hysterectomy scissors WERTHEIM	63
hemostatic clamp CRAFOORD-SELLORS	118	HOEN dura dissector	333		
hemostatic clamp CRILE	107	HOESEL needle holder	213	I	
hemostatic clamp CRILE-RANKIN	107	HOFER retractor	465	I.U.D. extractor hook	593
hemostatic clamp DANDY	109	HOFFMANN tubing clamp	624	I.U.D. SERPENTINE GRASPER	593
hemostatic clamp DEBAKEY-MOSQUITO	509	HOHMANN bone levers	284, 285	impactor/extractor	322/1
hemostatic clamp DEBAKEY-PEAN	513	HOHMANN MINI	286	incision scissors	52
hemostatic clamp DEBAKEY-RANKIN	512	HOKE chisels	265	INGE lamina spreader	339
hemostatic clamp DESJARDINS	121	holding arm system LEYLA	368 - 368/4	INGROWN nail instrument	612/1
hemostatic clamp FUCHSIG	113	holding clamp ADSON	298	INSTRU-CARE instrument oil	635
hemostatic clamp GEMINI	115	HOLINGER laryngoscope	37	instrument BOX	617
hemostatic clamp GRAY	121	HOLLINGER LIGHT GUIDE	37	instrument oil INSTRU CARE	635
hemostatic clamp GUYON	122	HOLSHER nerve hook	329	Insufflationcannula VERESS	206
hemostatic clamp HALSTED-MOSQUITO	105	HOLTH rongeur	380	interchangeable tips BARACANI	472
hemostatic clamp HALSTED-MOSQUITO titanium	105	HOLZBACH hysterectomy clamp	126	interchangeable tips BRUENINGS	472
hemostatic clamp HARTMANN	104	HOLZHEIMER retractor	168	interchangeable tips CORDES	472
hemostatic clamp HEISS	112	hook BALFOUR	193	interchangeable tips FRAENKEL	472

interchangeable tips FRAENKEL.....	472	IWANSON Measuring instrument.....	624	KERRISON rongeur.....	428
interchangeable tips KRAUSE.....	472			KEVORKIAN biopsy curette.....	587
interchangeable tips LANGE.....	472	J		KEVORKIAN biopsy forceps.....	589, 591
interchangeable tips SCHEINMANN.....	472	JACKSON laryngoscope.....	37	KEVORKIAN-PACIFIC biopsy forceps.....	592
interchangeable tips SCHUMACHER.....	472	JACKSON tendon grasping forceps.....	292	KEY elevator.....	282
interchangeable tips SEIFERT.....	472	JACKSON trachea hook.....	476	KEYES punch.....	608
intervertebral disc rongeur COLCLOUGH.....	344/1	JACKSON vaginal specula.....	573	kidney clamp GUYON.....	122
intestinal clamp BABY-KOCHER.....	540	JACKSON-BURROWS retractor.....	189/2	kidney forceps HERRICK.....	123
intestinal clamp Brunner.....	543	JACOBS hook forceps.....	583	kidney stone forceps HEIMING.....	536
intestinal clamp DOYEN.....	540	JACOBSON buttonprobes.....	335	kidney stoneforceps RANDALL.....	535
intestinal clamp FEHLAND.....	542	JACOBSON curette.....	257	kidney tray.....	619
intestinal clamp KOCHER.....	540	JACOBSON dura hook.....	335	KIELLAND obstetrical forceps.....	602
intestinal clamp MAYO-ROBSON.....	541	JACOBSON hemostatic clamp.....	105	KIELLAND-LUIKART obstetrical forceps.....	603
intestinal clamp PAYR.....	548	JACOBSON needle holder.....	215	KILLIAN gouges.....	442/1
intestinal clamp RESANO.....	542	JAEGER discision knife.....	372	KILLIAN nose specula.....	423
intestinal clamp SCUDDER.....	541	JAEGER lid plate.....	371	KILLIAN septum elevator.....	438, 439
intestinal clampSt.ONE-WATT.....	545	JAMESON strabismus forceps.....	385	KILLIAN septum scissors.....	471
intestinal forceps GREGOIRE.....	538	JAMESON strabismus hook.....	375	KILLIAN-CLAUS septum gouges.....	442/1
intestinal grasping forceps ALLIS.....	537	JANSEN bone curettes.....	257	KILNER needle holder.....	212
intestinal grasping forceps ALLIS-ADAIR.....	537	JANSEN bone rongeur.....	237	KILNER nose hook.....	447/1
intestinal grasping forceps ALLIS-BABY.....	537	JANSEN ear forceps.....	424	KILNER skin hook.....	608
intestinal grasping forceps ATRAUMA.....	111	JANSEN retractor.....	168	KILNER surgical scissors.....	54/1
intestinal grasping forceps BABCOCK.....	539	Jar.....	620	KILNER/RAGNELL supercut scissors.....	72
intestinal grasping forceps COLLIN.....	539	JARCHO hook forceps.....	583	KILNER-DOUGHTY mouth gag.....	456
intestinal grasping forceps DOYEN-BABY.....	540	JAVID carotid shunt clamp.....	511	KIRBY-ARTHUR IRIS forceps.....	385
intestinal grasping forceps DUVAL.....	539	JENNINGS mouth gags.....	454	KIRK mallet.....	270
intestinal grasping forceps JUDD-ALLIS.....	538	jewelry tissue forceps.....	90	KIRSCHNER.....	312
intestinal grasping forceps LITTLEWOOD.....	538	JOBSON-hornyE cotton-applicator.....	203	KIRSCHNER abdominal retractor.....	187, 187/1
intestinal grasping forceps LOCKWOOD-ALLIS.....	538	JOHNS-HOPKINS applier forceps.....	104	KIRSCHNER abdominal retractor.....	185, 187
intestinal grasping forceps THOMS-ALLIS.....	538	JOHNS-HOPKINS bulldog clamp.....	104	KIRSCHNER bone hand drills.....	299
intestinal grasping forceps WILLIAMS.....	539	JOHNS-HOPKINS hemostatic.....	120	KIRSCHNER drill wire.....	306, 307
intestinal spatula HABERER.....	143/3	JOHNSON needle holder.....	211	KIRSCHNER guideprobes.....	221
intestinal spatula LERICHE.....	143/4	JONES towel clamp.....	132	KIRSCHNER nail.....	308, 309
intestinal spatula REVERDIN.....	143/3	JONES-clip towel clamp.....	132	KIRSCHNER US extension bow.....	312
intestinal spatula RIBBON.....	143/1	JORGENSEN dissecting scissors.....	53	KLAPP retractor.....	150
intima spatula.....	530/1	JOSEPH (LEWIS) nose rasp.....	443	KLEINERT-KUTZ rongeur.....	237
intra oral retractors.....	463/1, 463/4	JOSEPH nose rasp.....	443	KLEINERT-KUTZ skin hook.....	149
intramedullary drills.....	322	JOSEPH nose saw.....	446	KLEINERT-KUTZ tendon grasping instrument.....	294
IOWA hook forceps.....	584	JOSEPH raspatories.....	277	KLEINSASSER chest support.....	36
IOWA needle guide.....	206	JOSEPH septum.....	437	KLEINSASSER injection cannula.....	36
Iris hook O'CONNOR.....	375	JOSEPH septum knives.....	434	KLEINSASSER light guide.....	36
Iris hook WIENER.....	375	JOSEPH septum knives.....	434, 435	KLEINSASSER suction tube tube.....	36
Iris knives DEAN.....	372	JOSEPH skin hook.....	149	KLEINSCHMIDT appendix intestinal clamp.....	544
Iris knives KNAPP.....	372	JOSEPH surgical scissors.....	54/1	KLINKENBERGH-LOTH vascular scissors.....	65/1
Iris knives ZIEGLER.....	372	JUDD-ALLIS intestinal grasping forceps.....	538	KNAPP cataract curette.....	378
IRIS scissors.....	54/2	JUDD-MASSON bladder retractors.....	552	KNAPP extraction hook.....	375
Iris scissors KNAPP.....	55	JUERS micro ear forceps.....	414	KNAPP iris knives.....	372
Iris scissors LITTLER.....	55	JURASZ laryngeal polypus forceps.....	471	KNAPP IRIS scissors.....	55
Iris spatula WECKER.....	378			KNAPP-LUER forceps.....	393
IRIS supercut scissors.....	72	K		KNIGHT septum forceps.....	425
Iris tissue forceps BARRAQUER-KATZIN.....	384	KABIERSKE powder blower.....	405	knives amputation.....	44
Iris tissue forceps BISHOP-HARMAN.....	386	KADER abdominal spatula.....	143/1	knives BALLENGER.....	436
Iris tissue forceps BONN.....	387	KALLMORGEN specula.....	573	knives bone.....	44
Iris tissue forceps FISCHER.....	384	KALT capsular forceps.....	391	knives LANGENBECK.....	47
Iris tissue forceps FOERSTER.....	383	KALT needle holder.....	214	knives MUCK.....	420
Iris tissue forceps GILL.....	384	KALT needle holder.....	214	knives PLESTER.....	418
Iris tissue forceps GILL-HESS.....	384	KALT-ARRUGA needle holder.....	214	knives ROSEN.....	418
Iris tissue forceps GRAEFE.....	382	KANE navelstringclamp.....	605	knives SCHUKNECHT.....	418
Iris tissue forceps HESS.....	384	KANTROWITZ hemostaticL.....	119	knives TABB.....	418
Iris tissue forceps KIRBY-ARTHUR.....	385	KAYE FACE LIFT scissors.....	73	knives WULLSTEIN.....	418
Iris tissue forceps ModELL BONN.....	387	KEINSASSER OP-laryngoscope.....	35	KNOWLES bandage scissors.....	70
Iris tissue forceps TROUTMAN.....	384; 389	KEITH needle.....	223	KOCHER bladder spatula.....	552
Iris tissue forceps type TUEBINGEN.....	387	KELLY GRIP retractor.....	142	KOCHER hemostatic clamp.....	108
Iris tissue forcepsSTEVENS.....	383	KELLY hemostatic clamp.....	106	KOCHER intestinal clamp.....	540
Irrigation cannula EICKEN (KILLIAN).....	433	KELLY hook.....	193	KOCHER probes.....	479
Irrigation cannula KILLIAN.....	433/1	KELLY proctoscope.....	562, 563	KOCHER retractor.....	155, 160, 163
Irrigation cannula KILLIAN.....	433/1	KELLY retractor.....	164	KOCHER-LANGENBECK retractor.....	159
Irrigation cannula RITTER-HALLE.....	433	KELLY uterine polyp forceps.....	585	KOENIG needle.....	223
Irrigation cannula SIMCOE.....	394/2	KELLY vascular scissors.....	61	KOERTE abdominal spatula.....	143/3
Irrigations cannula type LACRIMAL.....	394	KELLY-RANKIN hemostatic clamp.....	106	KOERTE retractor.....	162
ISRAEL retractor.....	162	Keratoplast.-knives BARRAQUER.....	373	KOGAN endo specula.....	577
ITPERSON trachea hook.....	477	Keratoplast.-knives PAUFIQUE.....	373	KÖNIG bone levers.....	284
IVES-FANSLER anoscope.....	562	KERN bone holding forceps.....	244	KÖNIG guideprobes.....	221/1

KÖNIG raspatories.....	276	LANGENBECK amputation knives.....	44	LOCKHART-MUMMERY fistula probes.....	200
KÖNIG retractor.....	153	LANGENBECK bone holding forceps.....	243	LOCKLIN gum scissors.....	69
KOOS dura knives.....	335	Langenbeck ear loop.....	409	LOCKWOOD-ALLIS intestinal grasping forceps.....	538
KRAUSE interchangeable tips.....	472	LANGENBECK FINGER saw.....	296	LONDON-COLLEGE teeth forceps.....	93
KRAUSE polyp snare.....	433/2	LANGENBECK knives.....	47	loop electrode MONOPOLAR.....	628, 629
KRAUSE polyp snare.....	411, 434	LANGENBECK needle holder.....	213	LOPEZ-REINKE tonsil.....	465
KRAUSE-VOSS polyp snare.....	433/2	LANGENBECK raspatories.....	275	LORENZ bandage scissors.....	70
KRAYENBÜHL nerve hook.....	336	LANGENBECK retractor.....	158, 159	LORNA towel clamp.....	133
KRISTELLER specula.....	572	LANGENBECK-GREEN retractor.....	153	LOUTE wire instrument.....	315
KRISTELLER vaginal specula.....	572	LARSEN tendon grasping forceps.....	292	LOVE nerve hook.....	329, 330
KROENIG tongue depressors.....	451	laryngeal cannula.....	470	LOVE retractor.....	465
KRONECKER ligaturee needle.....	219	laryngeal mirror.....	473	LOVE-GRUENWALD.....	340
KUGLEN hook.....	376	laryngeal mirror MICHEL.....	423	LOVELACE hemostatic clamp.....	109
KÜMMEL abdominal spatula.....	143/4, 144	laryngeal polypus forceps FRAENKEL.....	471	LOVELACE lung grasping forceps.....	490
KÜNTSCHER driver.....	321	laryngeal polypus forceps JURASZ.....	471	LOWER hemostatic clamp.....	120
KÜNTSCHER extractor.....	322	laryngoscope FOREGGER.....	29, 31	LOWMAN bone holding clamp.....	249
KÜNTSCHER reamer.....	321	laryngoscope handle cold light.....	33	LOWMAN-HOGLUND bone holding clamp.....	249
K-wire dispenser.....	310	laryngoscope handle warm light.....	32	LUBET-BARBON nose dressing forceps.....	424
L.....		laryngoscope handle with transformer.....	34	LUC septum forceps.....	426
LA FORCE adenoid curette.....	450	laryngoscope HOLLINGER.....	37	LUCAE ear forceps.....	410
LA FORCE foreign body needle.....	374	laryngoscope JACKSON.....	37	LUCAE hook.....	409
LA GRANGE gum scissors.....	69	laryngoscope MCINTOSH.....	29, 31	LUCAE mallet.....	271
LABORDE trachea dilator.....	476	laryngoscope MILLER.....	30	LUCAE paracentesis needle.....	408
lachrymal dilat. WILDER.....	381	Lateral vaginal retractor.....	569	LUCAE tuning forc.....	404
lachrymal dilat.CASTROVIEJO.....	381	LAWRENCE hemostatic clamp.....	119	LUCAS.....	260
lachrymal dilator ZIEGLER.....	381	lead hand.....	250	LUER bone rongeur.....	236
lachrymal dilator BOWMAN.....	381	LEBSCHKE skull breaker.....	267	LUER retractor.....	140
lachrymal probes HarmS.....	381	LEES bronchus clamp.....	504	LUER trachea cannula.....	479
LACRIMAL Irrigationscannula.....	394	LEGUE bladder retractors.....	553	LUER-KOERTE gall stone curette.....	533
LAGRANGE supercut scissors.....	72	LEGUEU bladder spatula.....	552	LUIKART obstetrical forceps.....	603
LAHEY grasping forceps.....	479	LEKSELL(STILLE) bone rongeur.....	240	LUNDSGAARD SKLEROTOM.....	373
LAHEY hemostatic clamp.....	120	LELAND-JONES vascular clamp.....	495	lung grasping forceps LOVELACE.....	490
LAHEY retractor.....	149, 157	LEMPERT bone curettes.....	256	lung scissors CRAFOORD.....	65/2
LAMBERT chalazio tissue forceps.....	393	LEMPERT bone rongeur.....	237	lung spatula ALLISON.....	489/2
LAMBERT-KAY aortic-ANASTOMosis clamp.....	505	LEMPERT elevator.....	420	LUNIATSCHEK.....	465
LAMBERT-LOWMAN bone holding clamp.....	249	LERCHE grasping tissue forceps.....	83	Lupus curette FOX.....	608
LAMBOTTE bone holding forceps.....	244	LERICHE abdominal spatula.....	143/4	Lupus curette PIFFARD.....	608
LAMBOTTE chisels.....	261	LERICHE hemostatic clamp.....	111	M.....	
LAMBOTTE raspatories.....	274, 275	LESTER fixation forceps.....	389	MAGILL CATETHER INTRODUCING FORCEPS.....	28
lamina spreader CLOWARD.....	339	LEVINSON foreign body needle.....	374	MAIER dressing forceps.....	134
lamina spreader INGE.....	339	LEWIN bone holding forceps.....	246	MAINGOT hysterectomy forceps.....	123/1, 123/2
laminectomy retractor CHERRY.....	488	LEXER BABY dissecting scissors.....	53	mallet.....	270, 272
laminectomy retractor forceps CLOWARD.....	342	LEXER chisels.....	263	mallet BERGMANN.....	272
laminectomy retractor forceps OLDBERG.....	341/1	LEXER dissecting scissors.....	53	mallet COLLIN.....	270
laminectomy retractor forceps SCHLESINGER.....	342	LEXER MINI gouges.....	263	mallet COTTLE.....	273
laminectomy retractor forceps SPURLING.....	340	LEYLA holding arm system.....	368, 368/4	mallet GERZOG.....	270
laminectomy retractor forceps WAGNER.....	343	LICHTENBERG needle holder.....	213	mallet HAJEK.....	273
laminectomy retractor forcepsCUSHING.....	340	LICHTWITZ trocar.....	204	mallet HEATH.....	273
laminectomy retractor forcepsFERRIS-SMITH.....	343	LIEBERMAN eye specula.....	324	mallet KIRK.....	270
laminectomy retractor forcepsLOVE-GRUENWALD.....	340	ligature rings.....	568	mallet LUCAE.....	271
laminectomy retractor SCOVILLE.....	196	ligature scissors.....	54	mallet MEAD.....	271
laminectomy retractor SCOVILLE-HAVERFIELD.....	196	ligaturee needle.....	218	mallet OMBREDANNE.....	273
LANCASTER eye specula.....	371	ligaturee needle COOPER.....	219	mallet PARTSCH.....	271
lancet electrode MONOPOLAR.....	628, 629	ligaturee needle DESCHAMPS.....	218	mallet QUISLING.....	271
LANDAU vaginal specula.....	577	ligaturee needle KRONECKER.....	219	mallet WILLIGER.....	271
LANDOLT TUMOR grasping forceps.....	341/2	ligaturee needle NELSON.....	219	MALTZ (COTTLE) nose rasp.....	444
LANE bender.....	325	ligaturee needle SCHMIEDEN-DICK.....	219	MALTZ nose rasp.....	443
LANE bone holding forceps.....	244	light guide HOLLINGER.....	37	mamaria sternum retractor.....	486
LANE bone levers.....	290	light guide JACKSON.....	37	mandibular body retractor HARGIS.....	463/6
LANE bone plate holding forceps.....	325	lip retractor.....	453	MANDRIN for tourniquet.....	528
LANE screw driver.....	323, 324	LISTER bandage scissors.....	69/1	MANOMETER.....	295, 596
LANE srewholdingforceps.....	325	LISTER SUPERCUT scissors.....	72	marker CONNIN-AMSLER.....	380
LANE stomach clamp.....	547	LISTER(SINUS) dressing forceps.....	137	MARQUARD bone rongeur.....	239
LANE surgical tissue forceps.....	84	LISTER-BURCH eye specula.....	370	MARSHIK tonsil forceps.....	468
LANE towel clamp.....	133	LISTON amputation knives.....	44	MARTEL grasping forceps.....	110
LANE TRETOWAN bone levers.....	290	LISTON bone cutting forceps.....	241	MARTIN bone holding forceps.....	246
LANG extraction dissector.....	378	LITTAUER cilia forceps.....	395	MARTIN CARTILAGE scissors.....	65/1
LANGE interchangeable tips.....	472	LITTAUER ear forceps.....	411	MARTIN pelvimeter.....	605
LANGE nose hook.....	448	LITTAUER polyp forceps.....	425	MARTIN retractor.....	175/1
LANGE-HOHMANN.....	286	LITTAUER suture scissors.....	66	MARTIN uterine-probes.....	586
LANGENBECK.....	311, 409	LITTLE retractor.....	157	MARTINI bone curettes.....	257
		LITTLE IRIS scissors.....	55	MASING septum elevator.....	437
		LITTLEWOOD intestinal grasping forceps.....	538		

MASSING-NEIVERT nose hook.....	447/1	METZENBAUM TC dissecting scissors.....	53/1	MORITZ-SCHMIDT tongue depressors.....	452
MASSON needle holder.....	210	MEYER bone holding forceps.....	248	MORRIS retractor.....	164
MASTIN muscle clamp.....	479	MEYERDING retractor.....	157	MORRIS-DEBAKEY aortic clamp.....	506
MATHIEU foreign body forceps.....	553/1	MEYERDING retractors.....	180	MORSE rib spreader.....	484
MATHIEU needle holder.....	213	MEYHOEFER chalazio curette.....	377	MORSE-FAVALORO rib spreader.....	484
MATHIEU rectal-specula.....	560	MICHEL clip.....	224	mouth gags DAVIS-BOYLE.....	455
MATHIEU retractor.....	141	MICHEL clip forceps.....	224	mouth gags DENHART.....	454
MATHIEU-OLSEN needle holder.....	212	MICHEL clip tissue forceps.....	224	mouth gags DINGMANN.....	456
MATSON raspatories.....	279	MICHEL laryngeal mirror.....	423	mouth gags HEISTER.....	454
MATSON-ALEXANDER raspatories.....	279	micro ear forceps.....	413	mouth gags JENNINGS.....	454
MAXI GRASPER biopsy forceps.....	593	micro ear forceps COS.....	414	mouth gags McIVOR.....	457
MAYFIELD bone rongeur.....	238	micro ear forceps DIETER.....	414	mouth gags ROSER-KOENIG.....	454
MAYO dissecting scissors.....	52	micro ear forceps GREVEN.....	414	mouth gagsDOYEN-JANSEN(MOLT).....	454
MAYO gall stone curette.....	534	micro ear forceps HAUGH.....	414	MOYNIHAN gall stone probes.....	531
MAYO gall stone probes.....	534	micro ear forceps JUERS.....	414	MOYNIHAN hemostatic clamp.....	121
MAYO sterilization clamp.....	227	micro ear forceps McGEE.....	414	MOYNIHAN towel clamp.....	133
MAYO supercut scissors.....	71	micro ear scissors BELLUCCI.....	413	MUCK knives.....	420
MAYO tissue forceps.....	89	micro ear scissors SHEA.....	413	MUELLER eye specula.....	371
MAYO tongue depressors.....	451	MICRO FRIEDMANN.....	234	MÜLLER APPROXIMATOR.....	364
MAYO-ADAMS retractors.....	171	MICRO FRIEDMANN bone rongeur.....	234	MÜLLER vascular clip.....	365
MAYO-BLAKE gall stone forceps.....	530/2	micro scissors.....	76,77, 78, 80	MÜNCHEN biopsy curette.....	587
MAYO-COLLINS retractor.....	141	micro scissors BELLUCCI.....	417	MURDOCK eye specula.....	370
MAYO-COLLINS retractor Set.....	141	micro scissors GOMEL.....	80	MURPHY retractor.....	156
MAYO-HABERISSER wire forceps.....	319	micro scissors HEPP-SCHIEDEL.....	78	MURPHY-LANE elevator.....	283
MAYO-HEGAR needle holder.....	209	micro scissors HADEO.....	77, 78, 80	muscle clamp MASTIN.....	479
MAYON-GUYON hemostatic clamp.....	122	micro sickle knives.....	475	muscle forceps PRINCE.....	387
MAYO-NOBLE dissecting scissors.....	52	micro tissue forceps.....	94	musclehook.....	267
MAY-OPHTHALMOSKOP UNI.....	14	micro-curette forceps WULLSTEIN.....	416	musclehook GREEN.....	375
MAYO-ROBSON intestinal clamp.....	541	micro-grasping forceps tube shaft.....	415	muscle forceps BERKE.....	389
MAYO-STILLE dissecting scissors.....	52	MICRO-HARTMANN hemostatic clamp.....	104	MUSEUX hook forceps.....	583
MAYO-STILLE supercut scissors.....	71	microsurgical tissue forceps GOMEL.....	96	MYLES nose forceps.....	427
MC DONALD elevator.....	283	MICROVASCULAR needle holder.....	210	myoma knives SEGOND.....	594
MC GIVNEY haemorrhoidal LIGATOR.....	568	MIDDELDORPF retractor.....	160	myoma screw DOYEN.....	594
MC INDOE bone cutting forceps.....	241	MIDDLETON-JANSEN septum forceps.....	430		
MC KENZIE drill.....	299	MIKULICZ intestinal clamp.....	543	N	
MCCULLOUGH strabismus forceps.....	385	MIKULICZ peritoneum clamp.....	123	NABATOFF varicose vein probes.....	201
MCGEE hook.....	419	MIKULICZ retractor.....	163	NAEGELE obstetrical forceps.....	603
MCGEE micro ear forceps.....	414	MIKULICZ-BABY peritoneum clamp.....	123	NAGER retractor.....	465
MCINDOE scissors.....	65/1	MILLER laryngoscope.....	30	NAGER tonsil needle.....	466
MCINDOE tissue forceps.....	85	MILLER nose rasp.....	444	nail brushes.....	611
MCINTOSH laryngoscope.....	29, 31	MILLIGAN dura dissector.....	332	nail drill.....	297
MCINTYRE eye cannula.....	394	MILLIN bladder retractors.....	552	nail files.....	612/1
MCIVOR mouth gags.....	457	MILLIN bladder spreader.....	553	nail forceps.....	609, 613
MCKENTY septum elevator.....	437, 438	MILLIN capsular grasping forceps.....	551	nail forceps Anvil.....	613
MCKENZIE applier forceps.....	326	MILLIN prostatic grasping forceps.....	551	nail forceps Radolf.....	297
MCLEAN obstetrical forceps.....	603/1	Mini bulldog clamp DEBAKEY-DIETHRICH.....	101	nail forceps TURNBULL.....	609
MCLEAN-LUIKART obstetrical forceps.....	603/1	Mini quick handle.....	301	nail impactor.....	322/1
MCLEAN-TUCKER-LUIKART obstetrical forceps.....	603/1	mini scalpel.....	41	nail nippers.....	612/2, 613, 614
MCPHERSON tissue forceps.....	392	mini scalpel handle.....	41	nail rasp.....	610
MEAD bone rongeur.....	235	Mini-bulldog clamp.....	101	nail scissors.....	609
MEAD mallet.....	271	MINI-LAMBOTTE chisels.....	262	nail SET.....	609
Measurement circle CASTROVIEJO.....	380	MINIMUS Sphygmomanometer.....	11, 12	nail skin forceps.....	613
Measuring instrument IWANSON.....	624	MINI-TOWNSEND-DOWN biopsy forceps.....	591	nail skin forceps.....	610, 613
medicine cup.....	621	MINI-TOWNSEND-UP biopsy forceps.....	591	Nail splitting scissors.....	614
medicine spoon.....	621	MIXTER gall stone forceps.....	530/2	needle BARBARA.....	419
MEEKER hemostatic clamp.....	119	MIXTER hemostatic clamp.....	116, 119, 120, 121	needle electrode MONOPOLAR.....	628, 629
MEHDORN applier forceps.....	362	MIXTER hemostatic clamp S-cvd.....	116	needle guide IOWA.....	206
MEHDORN vascular clip.....	362	MIXTER hemostatic clamp.....	119	needle holder ADSON.....	211
MELLINGER eye specula.....	370	MIXTER-BABY hemostatic clamp.....	119	needle holder ARRUGA.....	214
MELLINGER-AXENFELD eye specula.....	370	MIXTER-O'SHAUGNESSY.....	120	needle holder BABY-OLSEN-HEG.....	212
MENGHINI biopsy needle.....	206	MIXTER-O'SHAUGNESSY hemostatic clamp.....	120	needle holder BABY-WEBSTER.....	208
meniscus hook BLOUNT.....	289	MODELL BONN iris tissue forceps.....	387	needle holder BARRAQUER.....	217
meniscus knives NEFF.....	292	MOELTGEN goniometer.....	25	needle holder BARRAQUER Micro.....	216
meniscus knives SMILLIE.....	292	MOGEN circumcision instrument.....	556	needle holder BAUMGARTNER.....	208
MERCEDES thoracic spreader.....	489	MOLLISON retractors.....	171	needle holder BOYNTON.....	214
MERIAM teeth tissue forceps.....	93	MOLT raspatoriesIUM.....	276	needle holder BOZEMANN.....	211
METAL catheter.....	555	MONOPOLAR electrode ball.....	628, 629	needle holder BROWN.....	209
Metal catheter COXETER.....	555	MONOPOLAR electrode lancet.....	628, 629	needle holder CASTROVIEJO.....	215
METZENBAUM "S" surgical scissors.....	54	MONOPOLAR electrode loop.....	628, 629	needle holder Castroviejo.....	216
METZENBAUM dissecting scissors.....	53/1	MONOPOLAR electrode needle.....	628, 629	needle holder CASTROVIEJO Micro.....	215
METZENBAUM FINO TC dissecting scissors.....	53/1	MOOR gall stone scoop.....	531	needle holder cheekSTEEN.....	210
METZENBAUM needle holder.....	211	MOORE bone hand drills.....	298	needle holder COLLIER.....	208
METZENBAUM supercut scissors.....	71	MOORFIELD tissue forceps.....	392	needle holder CRILE.....	213
		MORGAN proctoscope.....	565		

needle holder CRILE-MURRAY	209
needle holder CRILE-WOOD TC	209
needle holder DE BAKEY	210
needle holder DERF	208
needle holder FINOCCHIETTO	211
needle holder GILLIES	212
needle holder HALSEY	208
needle holder HALSEY	208
needle holder HEANEY	210
needle holder HOESEL	213
needle holder JACOBSON	215
needle holder JOHNSON	211
needle holder KALT-ARRUGA	214
needle holder KILNER	212
needle holder LANGENBECK	213
needle holder LICHTENBERG	213
needle holder MASSON	210
needle holder MATHIEU	213
needle holder MATHIEU-OLSEN	212
needle holder MAYO-HEGAR	209
needle holder METZENBAUM	211
needle holder MICROVASCULAR	210
needle holder NEIVERT	208
needle holder OLSEN-HEGAR	212
needle holder RYDER	210
needle holder SAROT	211
needle holder St.EVENS	214
needle holder STRATTE	212
needle holder WEBSTER	208
needle nose plier	320
needle REVERDIN	220
needle ROSEN	419
needle sterilization case	615
needle YOUNG-BOOMERANG	220
needles	222, 223
NEFF meniscus knives	292
Negus CHEST SUPPORT	459
NEIVERT needle holder	208
NEIVERT-ANDERSON chisel	442
NELATON probes	199
NELSON ligaturee needle	219
NELSON STANDARD trocar	204
NELSON trocar	205
NELSON vasculartissue forceps	89
NEONATAL vascular clamp	523
Neonatal vascular clamp CASTANEDA	527
nerve hook CRILE	328
nerve hook CUSHING	328
nerve hook DANDY	328
nerve hook GRAHAM	328
nerve hook HOLSHER	329
nerve hook KRAYENBUEHL	336
nerve hook LOVE	329
nerve hook LOVE	330
nerve hook SACHS	328
nerve hook SCOVILLE	329, 330
nerve hook SMITHWICK	328
NEUGS tonsil forceps	467
neurosurgical SCISSOR STRULLY	65
neurosurgical scissors	65
NEWS trachea hook	477
nippers nail	612/2, 613, 614
Nissen fine hemostatic clamp	113
NISSEN hemostatic clamp	113
nmonopolar forceps	634
noise appartus POLITZER	405
NORDFOLK-NORWICH retractors	172
NORTHBENT suture scissors	66
nose dressing forceps LUBET-BARBON	424
nose dressing forceps WESTMACOTT	424
nose forceps CAPLAN	428
nose forceps HARTMANN	427
nose forceps MYLES	427
nose forceps SCHMEDEN	427
nose forceps STRUYCKEN	427
nose forceps TAKAHASHI	427
nose forceps WATSON-WILLIAMS	428
nose forceps WEIL-BLAKESLEY	426
nose hook	447
nose hook AUFRICHT	447
nose hook CONVERSE	448
nose hook COTTLE	447, 447/1
nose hook LANGE	448
nose hook MASING-NEIVERT	447
nose rasp FOMON	444, 445
nose rasp JOSEPH	443
nose rasp JOSEPH (LEWIS)	443
nose rasp MALTZ	443
nose rasp MALTZ (COTTLE)	444
nose rasp MILLER	444
nose rasp PEET	446
nose rasp WIENER	443
nose saw JOSEPH	446
nose scissors	429
nose scissors COTTLE	59
nose scissors FOMON	58
nose scissors HEYMANN	58
nose specula COTTLE	423
nose specula HARTMANN	422
nose specula HARTMANN-HALLE	421
nose specula KILLIAN	423
nose specula HADEO	423
nose specula THUDICHUM	421
nose specula TIECK-HALLE	423
nose specula type VIENNA	421
nose specula VOLTOLINI	421
noseolive POLITZER	406
NOTO uterine polyp forceps	585
NOVA Sphymomanometer	6, 7
NOVAK biopsy curette	587
NOYES eye scissors	75
NOYES polyp forceps	425
Nucleus Rotator Bechert	379
nystagmus spectacles FRENZEL	20
O	
obstetrical curette SELLHEIM	607
obstetrical forceps BARTON	603/2
obstetrical forceps BOERMA	604
obstetrical forceps DE LEE	602
obstetrical forceps ELLIOT	603
obstetrical forceps KIELLAND	602
obstetrical forceps KIELLAND-LUIKART	603
obstetrical forceps LUIKART	603
obstetrical forceps McLEAN	603/1
obstetrical forceps McLEAN-LUIKART	603/1
obstetrical forceps McLEAN-TUCKER	603/1
obstetrical forceps McLEAN-TUCKER-LUIKART	603/1
obstetrical forceps NAEGELE	603
obstetrical forceps PIPER	604
obstetrical forceps SIMPSON	602
obstetrical forceps SIMPSON-BRAUN	602
obstetrical forceps SIMPSON-LUIKART	603
obstetrical forceps THIERRY	603
obstetrical forceps WRIGLEY	602
OBWEGESER awl	463
OBWEGESER blade osteotome	464/1
OBWEGESER raspatories	462
OBWEGESER retractor	460, 461/1
OBWEGESER retractors	463
OCHSNER trocar	205
O'CONNOR iris hook	375
OEHLER surgical tissue forceps	81/1
OLDBERG laminectomy retractor forceps	341/1
OLIVECRONA bone rongeur	237
OLIVECRONA brain spatula	336
OLIVECRONA dura dissector	332
OLIVECRONA wire saw	332
OLIVECRONA-TOENNIS applicator forceps	326
OLLIER retractor	162
OLSEN-HEGAR needle holder	212
OMBREDANNE mallet	273
Optalmoskop MAY UNI II	14
OP-laryngoscope HOLINGER	37
OP-laryngoscope JACKSON	37
OP-laryngoscope KLEINSASSER	35
ophthalmologic scissors	57, 58
ophthalmologic scissors AEBLI	58
ophthalmologic scissors GRADLE	57
ophthalmologic scissors STEVENS	58
Oscillation plaster cast saw and accessories	230/10 - 230/18
osteotome blade OBWEGESER	464/1
osteotome EPKER	464/2
OSTROEM Antrum-punch	430
O'Sullivan-O' Connor abdominal retractor	181
O'SULLIVAN-O'CONNOR abdominal retractor	576
O'SULLIVAN-O'CONNOR abdominal retractors	181
OTIS urethrotome	553
Otоскоpe Diagnostic set UNI I	13
OVAL RING	194
OVERHOLT hemostatic clamp	114
OVERHOLT-BABY hemostatic clamp	114
OVERHOLT-GEISENDOERFFER hemostatic clamp	114
OVERHOLT-MIXTER hemostatic clamp	115
ovum curette CUZZI	606
ovum curette PESTALOZZA	606
ovum curette WALLICH	607
ovum forceps SAENGER	606
ovum forceps WINTER	606
P	
pan bed	621/1
pan placenta	621/1
paracentesis needle LUCAE	408
paracentesis needle POLITZER	408
parametrium clamp HADEO	128/1
PARAMETRIUM scissors	63
PARK eye specula	371
PARKER retractor	139
PARTSCH chisels	259
PARTSCH mallet	271
PASSOW	260
Passow chisels	260
PATELLA forceps	248
PATON corneal dissector	373
PAUFIQUE Keratoplast.-knives	373
PAUFIQUE tissue forceps	392
PAYR guide probes	221/1
PAYR intestinal clamp	548
PEAN hemostatic clamp	108
PEAN hemostatic clamp	110
PEAN hemostatic clamp	108, 110
PEAPOD rongeur	341/1
PECK-JOSEPH dissecting scissors	74
PEDERSON vaginal specula	570
PEENFIELD dissector	333
PEERS towel clamp	132
PEET nose rasp	446
PEET splinter forceps	92
PELMANN dressing forceps	137
pelvimeter COLLIER	605
pelvimeter MARTIN	605
Pelvis-hook St.MARKS	165
Penisclamp Stockmann	553/1
Penisclamp STRAUSS	553/1
PENNINGTON hemostatic clamp	109
PENNINGTON septum elevator	438
percussion mallet BABINSKY	24

percussion mallet BERLINER.....	24	PRATT fistula probes.....	563	raspatoriesium WIBERG.....	277
percussion mallet BUCK.....	24	PRATT grasping forceps.....	110	raspatoriesSEDLLOT.....	274, 275
percussion mallet TAYLOR.....	24	PRATT hook forceps.....	584	raspatory HARGIS.....	463/2
percussion mallet TROEMNER.....	24	PRATT rectal-specula.....	559	raspatory SELDING.....	277
PERCY RETRAKTOR.....	296	PRATT uterine Dilatatator.....	580	RAZOR blades.....	45
perforators SMELLIE.....	607	PRECISA Sphygmomanometer.....	9	reamer KUENTSCHER.....	321
Peripheral vascular clamp DE BAKEY.....	494	PRICE-THOMAS bronchus clamp.....	490	reamer KUENTSCHER.....	321
Peripheral vascular clamp LELAND-JONES.....	495	PRINCE muscle forceps.....	387	RECAMIER uterine curette.....	597
peritoneum clamp FAURE.....	123	PRINCE tonsil scissors.....	59	rectal biopsy forceps TURREL.....	567
peritoneum clamp MIKULICZ.....	123	PROBE AND PACKER.....	612	rectal suction tube BUJE.....	566
peritoneum clamp MIKULICZ-BABY.....	123	probe tips.....	201	rectalbiopsy forceps YEOMAN.....	566, 567
peritoneum clamp PHANEUF.....	123	probes.....	199	rectalsnare WESTON.....	566
PERKINS retractors.....	168	probes BRODIE.....	199	rectal-specula ALAN-PARKS.....	561
PERTHES awl.....	304	probes DOYEN.....	199	rectal-specula BARR.....	559
PESTALOZZA ovum curette.....	606	probes FISH.....	199	rectal-specula BODENHAMMER.....	559
petri box.....	620	probes Harms.....	333	rectal-specula CZERNY.....	559
PETZ stomach and intestinal suturing apparatus.....	549	probes JACOBSON.....	335	rectal-specula HILL-FERGUSSON.....	560
PHALANGEN knives.....	44	probes KOCHER.....	479	rectal-specula MATHIEU.....	560
PHANEUF peritoneum clamp.....	123	probes NELATON.....	199	rectal-specula PRATT.....	559
PIERCE septum.....	438	probes Valleix.....	586	rectal-specula SAWYER.....	560
PIERCE trocar.....	204	probes WATSON-CHEYNE.....	199	rectal-specula SCHULZE-BERG.....	560
PIFFARD LUPUS curette.....	608	probes Worst.....	333	rectum clamp HAYES.....	545
PILLING clip forceps.....	524	proctoscope Bensaude.....	565	HADEO tuning forc.....	403
pin cutter.....	320	proctoscope CHELSEA-EATON.....	563	HADEO amputation knife.....	44
PINARD stethoscope.....	23	proctoscope FANSLER.....	564	HADEO blade breaker.....	45
PINWHEEL WARTENBERG.....	25	proctoscope KELLY.....	562, 563	HADEO bone curettes.....	256
PIPER obstetrical forceps.....	604	proctoscope Morgan.....	565	HADEO bone hand drills.....	300
Pistol for cleaning.....	626	proctoscope MILLIN.....	551	HADEO bone holding forceps.....	246, 247
pituitary rongeur.....	341	prostatic grasping forceps.....	550	HADEO bone holding forceps.....	246, 247
placenta pan.....	621/1	prostatic hook YOUNG.....	550	HADEO cilia forceps.....	395
plaster cast saw ENGEL.....	229	PROVIDENCE-HOSPITAL hemostatic clamp.....	106	HADEO cotton-applicator.....	203
plaster cast saw oscillating and accessories.....	230/10 - 230/18	punch KEYES.....	608	HADEO EXCENTER bandage scissors.....	69/2
plaster forceps WOLFF.....	233	punction cannula FRAZIER.....	337	HADEO eye magnet.....	395
plaster knives ESMARCH.....	233	punction cannula QUINKE.....	206	HADEO Finger ring saw.....	297
plaster knives HOPKINS.....	233	PUTTI bone rasp.....	294	HADEO intestinal grasping forceps atrauma.....	111
plaster knives REINER.....	233	Pylorusretractor BENSON.....	544	HADEO nose specula.....	423
plaster knives WIGMORE.....	229	Q		HADEO parametrium clamps.....	128/1
plaster retractor BEESON.....	232	QUERVAIN elevator.....	275	HADEO plaster retractor.....	232
plaster retractor HAGLUND-STILLE.....	232	quick handle.....	301	HADEO sickle knives.....	435
plaster retractor HENNIG.....	232	QUINBY gum scissors.....	67	HADEO skin hook.....	150
plaster retractor HADEO.....	232	QUINKE punction cannula.....	206	HADEO sterilization forceps.....	615
plasterscissorsSTILLE.....	229	QUIRE foreign body lever.....	412	HADEO suture fork.....	221/1
platte JAEGER.....	371	QUISLING mallet.....	271	REDON guide needle.....	207
PLESTER knives.....	418	R		REES FACE LIFT scissors.....	73
PLESTER retractors.....	171	RACHOTOM.....	267	REICHERT DECKEL epiglottis retractor.....	471
PLESTER suction tube.....	338	RADOLF nail forceps.....	297	REILL bone holding forceps.....	248
pneumatic tournique.....	295	RALK bone hand drills.....	300	REINER ear syringe.....	406
POLITZER air blower.....	406	RAMPLEY dressing forceps.....	136	REINER plaster knives.....	233
POLITZER ear knives.....	408	RAMUS retractor.....	461	REKORO syringe.....	596
POLITZER ear specula.....	399	RANDALL biopsy curette.....	587	RESANO capsula scissors.....	53/2
POLITZER noseOLIVE.....	406	RANDALL kidney stone forceps.....	535	RESANO intestinal clamp.....	542
POLITZER paracentesis needle.....	408	RANEY appling forceps.....	327	RESECTION knives.....	47
polyp forceps HARTMANN.....	424	RANGELL retractor.....	140	retractor ALM.....	168
polyp forceps LITTAUER.....	425	raspatories.....	279	retractor ANDERSON.....	198
polyp forceps NOYES.....	425	raspatories ADSON.....	282	retractor assembly.....	188
polyp loop.....	411	raspatories ALEXANDER.....	276	retractor AUFRANC.....	289
polyp snare KRAUSE.....	433/2	raspatories COBB.....	280	retractor breast.....	198
polyp snare KRAUSE.....	411, 434	raspatories DINGMANN.....	463, 463/3	retractor BRUNNER.....	167
polyp snare KRAUSE-VOSS.....	433/2	raspatories DOYEN.....	278	retractor COLLIN.....	139
polyp snare WILDE.....	433/2	raspatories FARABEUF.....	274	retractor COLLIN HARTMANN.....	141
polyp snare WILDE.....	411, 434	raspatories FARABEUF-COLLIN.....	274	retractor COOLEY.....	148
POOLE suction tube.....	27	raspatories FOMON.....	277	retractor CORONAL BLOW LIFT.....	198
POST MORTEM.....	268	raspatories JOSEPH.....	277	retractor CORYLLOS.....	166
POST MORTEM knives.....	48	raspatories KOENIG.....	276	retractor CRILE.....	140
POST MORTEM knives VIRCHOW.....	48	raspatories LAMBOTTE.....	274	retractor CUSHING.....	151
post mortem set.....	269	raspatories LANGENBECK.....	275	retractor CZERNY.....	141
POTTS SMITH tissue forceps.....	81	raspatories LANGENBECK.....	275	retractor DAVIDSON (Scapula).....	166
POTTS-DE MARTEL vascular scissors.....	59	raspatories MATSON.....	279	retractor DEEVER.....	145
POTTS-SMITH tissue forceps.....	81	raspatories MATSON-ALEXANDER.....	279	retractor DEEVER GRIP.....	146
POTTS-SMITH vascular scissors.....	61	raspatories OBWEGESER.....	462	retractor DEBAKEY.....	189/1
POZZI-PALMER tenaculum forceps.....	582	raspatories SEMB.....	278	retractor DELEE.....	574
		raspatories WILLIGER.....	276	retractor DESMARRES.....	151
		raspatoriesium MOLT.....	276	retractor DESMARRES.....	151

retractor DOYEN.....	163	retractors BECKMANN.....	176	rongeur HAJEK-KOFLER.....	429, 431
retractor DOYEN-STILLE.....	167	retractors BECKMANN-ADSON.....	175	rongeur HOLTH.....	380
retractor FARABEUF.....	139	retractors BECKMANN-EATON.....	176	rongeur KERRISON.....	428
retractor FERRIERA.....	197	retractors CASPAR.....	179, 180	rongeur PEAPOD.....	341/1
retractor FINSEN.....	168	retractors DARLING.....	178	ROSE retractor.....	140
retractor Freeman.....	198	retractors HENLEY.....	170	ROSEN knives.....	418
retractor FRITSCH.....	163	retractors MAYO-ADAMS.....	171	ROSEN needle.....	419
retractor GIL-VERNET.....	152	retractors MEYERDING.....	180	ROSEN suction tube.....	338
retractor GOELET.....	141	retractors MOLLISON.....	171	ROSER-KOENIG.....	454
retractor GREEN.....	160	retractors NORFOLK NORWICH.....	172	ROSS retractor.....	148/1
retractor HARRINGTON.....	147	retractors PERKINS.....	168	ROUND RING MEDIUM.....	194
retractor HARRINGTON-PEMBERTON.....	147	retractors PLESTER.....	171	ROUX MINI retractor.....	140
retractor HASSON.....	143	retractors SCALP-CONTOUR.....	169	ROUX retractor.....	139
retractor HEANEY.....	164	retractors TRAVERS.....	172	ROUX-BABY retractor.....	140
retractor HIBBS.....	164	retractors WEITLANER.....	169	ROWE reposition forceps.....	459
retractor HOESEL.....	167	retractors WULLSTEIN.....	171	RUBIN septum forceps.....	428
retractor HOFER.....	465	Retraktor PERCY.....	296	RUDD haemorrhoidal ligator.....	568
retractor HÖLZHEIMER.....	168	REVERDIN intestinal spatula.....	143/3	ruler metal.....	25
retractor ISRAEL.....	162	REVERDIN needle.....	220	RUMEL hemostatic clamp.....	117
retractor JACKSON-BURROWS.....	189/2	REYNOLDS supercut scissors.....	72	RUMEL-BELMONT tourniquet.....	528
retractor JANSEN.....	168	REYNOLDS surgical scissors.....	54	RUskin bone rongeur.....	239
retractor KELLY.....	164	rhinoplastic scissors FOMON.....	65/1	RUskin-LISTON bone cutting forceps.....	241
retractor KELLY GRIP.....	142	rib contractor SELLORS.....	489/1	RUSS MODELL grasping tissue forceps.....	85
retractor KLAPP.....	150	rib scissors.....	480	RUSSEL-DAVIS mouth gag.....	458
retractor KOCHER.....	155	rib scissors BETHUNE.....	481	RYDEL-SEIFFERT tuning forc.....	404
retractor KOCHER.....	160, 163	rib scissors BRUNNER.....	481	RYDER needle holder.....	210
retractor KOCHER-LANGENBECK.....	159	rib scissors CORYLLOS.....	480		
retractor KOERTE.....	162	rib scissors GIERTZ-STILLE.....	481	S	
retractor KÖNIG.....	153	rib scissors GLUCK.....	480	SAALFELD comedone extractor.....	608
retractor LAHEY.....	157	rib scissors SAUERBRUCH.....	481	SACHS dura dissector.....	332
retractor LANGENBECK.....	158, 159	rib scissors SAUERBRUCH-FREY.....	481	SACHS nerve hook.....	328
retractor LANGENBECK-GREEN.....	153	rib scissors STILLE.....	480	SAENGER ovum forceps.....	606
retractor LITTLE.....	157	rib spreader BAILEY.....	489/1	sagittal split retractor SMITH.....	463/5
retractor LOVE.....	465	rib spreader BAILEY-BABY.....	489/1	SalpingographSCHULTZE.....	596
retractor MARTIN.....	175/1	rib spreader BAILEY-GIBBON.....	489/1	SANVENERO surgical scissors.....	54/1
retractor MATHIEU.....	141	rib spreader COOLEY.....	487	SAROT hemostatic clamp.....	118
retractor MEYERDING.....	157, 177	rib spreader COOLEY-NEONATAL.....	485	SAROT needle holder.....	211
retractor MEYERDING.....	177	rib spreader DE BOER.....	486	SATINSKY tangential clamp.....	502
retractor MITTELDOERPF.....	160	rib spreader FINOCCHIETTO.....	482, 484	SATINSKY vascular clamp.....	491
retractor MIKULICZ.....	163	rib spreader FINOCCHIETTO-BURFORD.....	483	SATINSKY vascular scissors.....	65/1
retractor MORRIS.....	164	rib spreader HAIGHT.....	487	SATTERLEE amputation saw.....	296
retractor MURPHY.....	156	rib spreader MORSE.....	484	SAUERBRUCH bone rongeur.....	240
retractor NAGER.....	465	rib spreader MORSE-FAVALORO.....	484	SAUERBRUCH retractor.....	164
retractor OBWEGESER.....	460, 461/1	rib spreader RIENHOFF-FINOCCHIETTO.....	486	SAUERBRUCH retractor.....	164, 166
retractor OLLIER.....	162	rib spreader TUFFIER.....	487	SAUERBRUCH rib scissors.....	481
retractor PARKER.....	139	RIBBON intestinal spatula.....	143/1	SAUERBRUCH waste forceps.....	227
retractor RAGNELL.....	140	RICARD abdominal retractor.....	191	SAUERBRUCH-FREY sternum scissors.....	481
retractor RAMUS.....	461	RICHARDSON retractor.....	142	saw GIGLI.....	332
retractor RICHARDSON.....	142	RICHARDSON-EASTMAN retractor.....	142	SAWTELL tonsil forceps.....	467
retractor RICHARDSON GRIP.....	142	RICHARDSON-GRIP retractor.....	142	SAWYER rectal specula.....	560
retractor RICHARDSON-EASTMAN.....	142	RICHNAU-HOLMGREN ear specula.....	400	SAYRE elevator.....	281
retractor ROSE.....	140	RICHTER-HEATH clip forceps.....	224	SCAGLIETTI bone rongeur.....	240
retractor ROSS.....	148/1	RIENHOFF-FINOCCHIETTO rib spreader.....	486	scalp forceps GAUSS.....	605
retractor ROUX.....	139	RIGBY abdominal retractor.....	189/2	SCALP-CONTOUR retractors.....	169
retractor ROUX-BABY.....	140	RI-MINI Diagnostic set.....	17	scalpel.....	46
retractor ROUX-MINI.....	140	RING tongue depressors.....	455	scalpel blade.....	42
retractor SAUERBRUCH.....	164	rings ligature.....	568	scalpel blade remover.....	42
retractor SAUERBRUCH.....	164, 166	RITTER-HALLE irrigation cannula.....	433	scalpel handle.....	38, 39, 39/1, 39/2, 40, 42
retractor SENN-GREEN.....	153	ROBB spatula.....	530	scalpel handle COLLIN.....	40
retractor SENN-MILLER.....	143	ROBERTS hemostatic clamp.....	117	scalpel handle MINI.....	41
retractor SIMON.....	164	ROCHARD abdominal retractors.....	186	scalpel MINI.....	41
retractor SPINA-NASALIS.....	461	ROCHESTER-CarmALT hemostatic clamp.....	109	SCHAEDEL towel clamp.....	132
retractor TEBBETS.....	197	ROCHESTER-OCHSNER hemostatic clamp.....	108	SCHAMBERG comedone extractor.....	608
retractor TESSIER.....	463/3	ROCHESTER-PEAN hemostatic clamp.....	108	SCHEDI bone curettes.....	251
retractor TUFFIER.....	147	ROEDER towel clamp.....	132	SCHIEI goniotomy knives.....	373
retractor US-armY PARKER-LANGENBECK.....	141	ROGER septum.....	437	SCHENMANN interchangeable tips.....	472
retractor VOLKMANN.....	153	ROGERS hysterectomy clamp.....	127	SCHERBAK vaginal specula.....	575
retractor VOLKMANN.....	156	ROGGE sterilization forceps.....	227	SCHINK dermatome.....	49
retractor YANCOSKIE.....	198	ROLLET EXTIRPATION chisels.....	374	SCHIOETZ tonometer.....	394/2
retractor ZENKER.....	161	ROLLET extraction hook.....	375	SCHLESINGER laminectomy retractor forceps.....	342
retractors ADSON.....	173	rongeur CITELLI.....	430	SCHMEDEN nose forceps.....	427
retractors ADSON.....	172, 173, 174	rongeur DECKER.....	341	Schmid vascular-irrigation cannula.....	338
retractors ANDERSON-ADSON.....	172	rongeur FERRIS-SMITH-KERRISON.....	344, 344/2	SCHMIEDEN guideprobes.....	221

SCHMIEDEN-DICK ligaturee needle.....	219, 221	septum chisels FREER.....	439	skin hook FREER.....	448
SCHMIEDEN-TAYLOR durascissors.....	65/1	septum chisels SHEEHAN.....	441	skin hook GILLIES.....	448
SCHNIDT tonsil forceps.....	467	septum chisels SILVER.....	442	skin hook GRAEFE.....	148/2
SCHOENBORN thyroid gland hook.....	479	septum elevator BALLENGER.....	439	skin hook GUTHRIE.....	148/2
SCHRÖDER hook forceps.....	583, 584	septum elevator COTTLE.....	439	skin hook JOSEPH.....	149
SCHRÖDER uterine curette.....	595	septum elevator COTTLE-JOSEPH.....	439	skin hook KILNER.....	608
SCHROEDER(POZZI) hook forceps.....	582	septum elevator FREER.....	437	skin hook KLEINERT-KUTZ.....	149
SCHUBERT biopsy forceps.....	588	septum elevator HAJEK-BALLENGER.....	439	skin hook HADEO.....	150
SCHUKNECHT knives.....	418	septum elevator HALLE.....	437	skin punch KEYE.....	608
SCHULTZE salpingrograph.....	596	septum elevator HOWARTH.....	438	skin punch KEYE.....	608
SCHULZE-BERGMANN rectal-specula.....	560	septum elevator JOSEPH.....	437	skin scissors.....	610
SCHUMACHER biopsy forceps.....	588, 589	septum elevator KILLIAN.....	438	skin STRAIGHTENING blade FOR DERMATOME.....	49
SCHUMACHER episotomy scissors.....	64	septum elevator MASING.....	437	slip joint plier.....	317
SCHUMACHER interchangeable tips.....	472	septum elevator MCKENTY.....	437, 438	SLS clip forceps.....	524
SCHUMACHER sternum scissors.....	481	septum elevator PENNINGTON.....	438	SLUDER-BALLENGER.....	470
SCHWEIGGER capsular forceps.....	391	septum elevator PIERCE.....	438	SMELLIE hook.....	605
scissors CASTROVIEJO.....	79	septum elevator ROGER.....	437	SMELLIE perforators.....	607
scissors CASTROVIEJO.....	79	septum forceps BRUENINGS.....	425	SMILLIE bone levers.....	291
scissors COTTLE.....	56	septum forceps HEYMANN.....	425	SMILLIE meniscusknives.....	292
scissors DOYEN.....	63	septum forceps KNIGHT.....	425	SMITH eye specula.....	370
scissors enterotomy.....	66	septum forceps LUC.....	426	SMITH ramus seperator.....	463
scissors ENUCLEATION.....	58	septum forceps MIDDLETON-JANSEN.....	430	SMITH sagittal split retractor.....	463/5
scissors GORNEY.....	73	septum forceps RUBIN.....	428	SMITH US army bandage scissors.....	69/1
scissors GRAEFE.....	56	septum gouges FREER.....	442/1	SMITH-BUIE ANAL retractor.....	561
scissors HEPP-SCHUIDEL.....	78	septum gouges HAJEK.....	442/1	SMITH-PETERSEN.....	261
scissors MARTIN CARTILAGE.....	65/1	septum gouges KILLIAN-CLAUS.....	442/1	SMITH-PETERSEN bone rongeur.....	238
scissors McINDOE.....	65/1	septum knives CONVERSE.....	435	SMITHWICK applier forceps.....	326
scissors micro.....	76	septum knives COTTLE.....	435	SMITHWICK nerve hook.....	328
scissors neurosurgical.....	65	septum knives FREER.....	434	SNELLEN cataract loop.....	378
scissors Parametrium.....	63	septum knives JOSEPH.....	434, 435	SNELLEN uteriotrium forceps.....	393
scissors REES.....	73	septum scissors KILLIAN.....	471	SOMER uterine-grasping forceps.....	585
scissors SIEBOLD.....	62	septum straightening forceps ASCH.....	449	spare blade.....	49
scissors SIMS.....	62	septum straightening forceps WALSHAM.....	449	spatula.....	203, 530/1, 612
scissors THOREK.....	65/2	SERPENTINE biopsy forceps.....	593	SPATULA AND PACKER.....	612
scissors WAGNER.....	67	SEUTIN bandage scissors.....	69/2	spatula Hirschman.....	379
scissors WERTHEIM.....	63	SEXTON ear knives.....	408	specula FRIEDMANN.....	577
sclerotome GUYTON-LUNDSGAARD.....	373	SHAPLEIGH ear loop.....	410	specula KALLMORGEN.....	573
sclerotome LUNDSGAARD.....	373	SHAVER knives.....	49	specula KRISTELLER.....	572
SCOVILLE bone curette.....	253	SHEA micro ear scissors.....	413	specula O'SULLIVAN-O'CONNOR.....	576
SCOVILLE hook.....	196	SHEEHAN chisels.....	441	SPENCER suture scissors.....	66
SCOVILLE laminectomy retractor.....	196	SHEETS eye cannula.....	394/2	SPENCER-WELLS hemostatic clamp.....	109
SCOVILLE nerve hook.....	329, 330	sickle knives HADEO.....	435	Sphygmomanometer BABYPHON.....	10
SCOVILLE-HAVERFIELD laminectomy retractor.....	196	SIEBOLD gynecological scissors.....	62	Sphygmomanometer DIPLOMAT.....	5
screw driver.....	232	SIEGLE ear specula.....	402	Sphygmomanometer EXACTA.....	8
screw driver LANE.....	323	Silver clips.....	326	Sphygmomanometer MINIMUS.....	11, 12
screw driver WILLIAMS.....	323	SILVER DERMATOM.....	50	Sphygmomanometer NOVA.....	6, 7
screw holding sleeve.....	324	SILVER septum chisels.....	442	Sphygmomanometer PRECISA.....	9
SCUDDER intestinal clamp.....	541	SIMCOE irrigation cannula.....	394/2	SPINAL bone currettes.....	253
SEBILEAU elevator.....	275	SIMON retractor.....	164	Spinal hook TAYLOR.....	291
Section needle.....	268	SIMON uterine curette.....	594	SPINA-NASALIS retractor.....	461
SEDLLOT raspatories.....	274	SIMPLEX tubing clamp.....	624	splinterforceps ARCHER.....	92
SEGMENTED RING.....	194	SIMPSON obstetrical forceps.....	602	splinterforceps PEET.....	92
SEGOND hysterectomy clamp.....	125	SIMPSON-BRAUN obstetrical forceps.....	602	splinterforceps VIRTUS (RALK).....	92
SEGOND myoma knives.....	594	SIMPSON-LUIKART obstetrical forceps.....	603	splinterforcepsSTIEGLITZ.....	92
SEGOND-LANDAU hysterectomy clamp.....	125	SIMS gynecological scissors.....	62	splintertissue forceps.....	91
SEIFERT interchangeable tips.....	472	SIMS rectal-specula.....	559	splintertissue forceps CARMALT.....	91
SELLDIN raspatory.....	277	SIMS uterine curette.....	597	splintertissue forceps FEILCHENFELD.....	91
SELLHEIM obstetrical curette.....	607	SIMS uterine depressor.....	586	splintertissue forceps HUNTER.....	91
SELLORS rib contractor.....	489/1	SIMS uterine dilator.....	581	spoon medicine.....	621
SEMB bone cutting forceps.....	242	SIMS uterine probes.....	586	SPRATT bone currettes.....	251
SEMB bone holding forceps.....	243	SIMS vaginal specula.....	573	spreader DAVIS-BOYLE.....	455
SEMB bone rongeur.....	240	SIMS-MAIER dressing forceps.....	134	spreader DAVIS-MEYER.....	457
SEMB bronchusclamp.....	491	SINGLEY tissue forceps.....	88	spreader DINGMANN.....	456
SEMB raspatories.....	278	Sinskey hook.....	376	spreader KILNER-DOUGHTY.....	456
SEMKEN anatomic tissue forceps.....	86	Sinus probes.....	438	SPURLING laminectomy retractor forceps.....	340
SEMKEN surgical tissue forceps.....	86	SINUS septum elevator.....	438	sputum cup.....	621/1
SEMM vaginal specula.....	571	sinuscopy forceps.....	431	srewholding forceps LANE.....	325
SENN-GREEN retractor.....	153	sinuscopy-trocar.....	205	ST. CLAIR-THOMSON adenoid curette.....	450
SENN-MILLER retractor.....	143	SKENE hook forceps.....	582	ST.MARKS pelvis hook.....	165
septum cannula.....	406	skin hook COTTLE.....	447, 448	ST.MARTIN tissue forceps.....	392
septum chisels CINELLI.....	441	skin hook COTTLE-NEIVERT.....	448	STACKE earprobes.....	199
septum chisels COTTLE.....	440	skin hook FOMON.....	447/1	STAMMBERGER forceps.....	431
septum chisels FOMON.....	441	skin hook FRAZIER.....	148/2	STAUDE-MOORE hook forceps.....	582

STEINMANN ENDER nail.....	307, 308	suction tube DEBAKEY.....	28	TC scissors PECK-JOSEPH.....	74
STEINMANN tendon holdingforceps.....	292	suction tube FRAZIER/FERGUSSON.....	337	TC scissors REES.....	73
STELLBRINK bone rongeur.....	234	suction tube HOUSE.....	337/2	TC surgical scissors STANDARD.....	51
STERILE scalpel-blade.....	42	suction tube PLESTER.....	338	TC tissue forceps CUSHING.....	83
STERILE spare blade.....	50	suction tube POOLE.....	27	TC tissue forceps GILLIES.....	86
sterilization clamp BUNT.....	227	suction tube ROSEN.....	338	TC tissue forceps SEMKEN.....	86
sterilization clamp MAYO.....	227	suction tube tube KLEINSASSER.....	36	TC tissue forceps surgical.....	81
sterilization forceps.....	227	suction tube YANKAUER.....	27	TC tissue forceps WANGENSTEEN.....	89
sterilization forceps.....	227	suction tube YASARGIL.....	337/1	TC tissue forcepsN ANATOMIC.....	81
sterilization forceps CHEATLE.....	227	suction tube ZOELLNER.....	337/1	TC-scissors Gorney.....	73
sterilization forceps HADEO.....	615	supercut scissors.....	71	TC-scissors KAYE.....	73
sterilization forceps ROGGE.....	227	supercut scissors BABY METZENBAUM.....	71	TEALE hook forceps.....	583
sterilization forceps UNIVERSAL.....	227	supercut scissors FREEMAN.....	74	TEBBETTS retractor.....	197
sterilization tray.....	622, 623	supercut scissors GORNEY.....	73	teeth tissue forceps LONDON-COLLEGE.....	93
sterilization tray.....	618	supercut scissors IRIS.....	72	teeth tissue forceps MERIAM.....	93
STERNBERG cheek retractor.....	453	supercut scissors KAYE.....	73	tenaculum forceps ADAIR.....	582
sternum scissors SCHUMACHER.....	481	supercut scissors KILNER/RAGNELL.....	72	tenaculum forceps POZZI-PALMER.....	582
Sternumchisels LEBSCHKE.....	267	supercut scissors LAGRANGE.....	72	tendon grasping forceps.....	293
stethoscope ANESTOPHON.....	23	supercut scissors LISTER.....	72	tendon grasping forceps JACKSON.....	292
stethoscope DUPLEX.....	23	supercut scissors MAYO.....	71	tendon grasping forceps LARSEN.....	292
stethoscope PINARD.....	23	supercut scissors MAYO-STILLE.....	71	tendon grasping instr KLEINERT-KUTZ.....	294
STEVENS iris tissue forceps.....	383	supercut scissors METZENBAUM.....	71	tendon grasping instrument BRAND.....	293
STEVENS lens hook.....	375	supercut scissors REES.....	73	tendon grasping instrument CAROLL.....	293
STEVENS needle holder.....	214	supercut scissors REYNOLDS.....	72	tendon guide BUNELL.....	294
STEVENS ophthalmologic scissors.....	58	supercut scissors STEVENS.....	72	tendon holding forceps STEINMANN.....	292
STEVENS supercut scissors.....	72	supercut scissors WAGNER.....	72	tendon passing instr. BRAND.....	294
STEVENSON eye specula.....	371	surgical needle KEITH.....	223	tendon passing instr. BUNNELL.....	292
STIEGLITZ splinter forceps.....	92	surgical needle KOENIG.....	223	TERSON capsular forceps.....	391
STILLE anatomic tissue forceps.....	81	surgical scissors FERGUSSON.....	66	TESSIER retractor.....	463/3
STILLE bone hand drills.....	298	surgical scissors fine IRIS.....	54/2	T-handle.....	300, 301
STILLE chisels.....	260	surgical scissors fine JOSEPH.....	54/1	T-handle HUDSON.....	300
STILLE chisels.....	260	surgical scissors fine KILNER.....	54/1	THIERRY obstetrical forceps.....	603
STILLE gouges.....	260	surgical scissors fine REYNOLDS.....	54/1	THOMAS uterine curette.....	599
STILLE-LISTON bone cutting clamp.....	122	surgical scissors fine SANVENERO.....	54/1	THOMAS-GAYLOR biopsy forceps.....	588
STILLE plaster scissors.....	229	surgical scissors METZENBAUM.....	51, 54/1	THOMS-ALLIS intestinal grasping forceps.....	538
STILLE rib scissors.....	480	surgical scissors STANDARD.....	51	THOMSON-WALKER bladder retractors.....	552
STILLE surgical tissue forceps.....	81	surgical scissors SYSTRUNK.....	66	thoracic spreader MERCEDES.....	489
STILLE-BARRAYA vascular tissue forceps.....	88	surgical tissue forceps.....	81	THOREK scissors.....	65/2
STILLE-HORSLEY bone cutting forceps.....	242	surgical tissue forceps ADSON.....	81/2	THUDICHUM nose specula.....	421
STILLE-LISTON bone cutting forceps.....	241	surgical tissue forceps ADSON Micro.....	81/2	thyroid gland hook SCHOENBORN.....	479
STILLE-LUER bone rongeur.....	239	surgical tissue forceps ADSON-BROWN.....	82	TIECK-HALLE nose specula.....	423
STILLE-RUSKIN bone rongeur.....	239	surgical tissue forceps BONNEY.....	88	TILLEY ear forceps.....	411
STILLE-SHERMAN bone hand drills.....	298	surgical tissue forceps BROPHY.....	84	TIP for suction tube.....	27
STOCKMANN penis clamp.....	553/1	surgical tissue forceps CUSHING.....	83	TISCHLER-DOWN biopsy forceps.....	591
stomach clamp LANE.....	547	surgical tissue forceps FERRIS-SMITH.....	85	TISCHLER-KEVORKIAN biopsy forceps.....	592
stomach-/intestinal suturing apparatus V.PETZ.....	549	surgical tissue forceps GERALD.....	87	TISCHLER-MORGAN biopsy forceps.....	591
stomach-intestinal clamp MIKULICZ.....	543	surgical tissue forceps GILLIES.....	86	TISCHLER-MORGAN biopsy forceps.....	590, 591
STONE forceps.....	545	surgical tissue forceps LANE.....	84	TISCHLER-UP biopsy forceps.....	591
Stone holding clamp.....	545	surgical tissue forceps OEHLER TC.....	81/1	tissue forceps.....	90, 94
STONE-WATT.....	545	surgical tissue forceps Potts Smith.....	81	tissue forceps anatomic.....	81
strabismus forceps BONACCOLTO.....	385	surgical tissue forceps SEMKEN.....	86	tissue forceps bipolar.....	630, 631
strabismus forceps DASTOOR.....	386	surgical tissue forceps STILLE.....	81	tissue forceps BONNEY.....	88
strabismus forceps JAMESON.....	385	surgical tissue forceps TAYLOR.....	87	tissue forceps BROWN.....	83
strabismus forceps McCULLOUGH.....	385	surgical tissue forceps type USA.....	81/1	tissue forceps CASTROVIEJO.....	392
strabismus hook GRAEFE.....	375	surgical tissue forceps WAUGH.....	83	tissue forceps DAVIS.....	227
strabismus hook JAMESON.....	375	suture fork HADEO.....	221/1	tissue forceps DeBakey.....	99
STRANDELL-STILLE retractor.....	157	suture scissors HEATH.....	66	tissue forceps Gerald.....	86, 87
STRASSBURGER tissue forceps.....	89	suture scissors LITTAUER.....	66	tissue forceps GOMEL.....	96
STRATTE needle holder.....	212	suture scissors NORTHBENT.....	66	tissue forceps GRAEFE.....	83
STRAUSS penis clamp.....	553/1	suture scissors SPENCER.....	66	tissue forceps jewelry.....	90
Stripper.....	202	SWEET applicator forceps.....	326	tissue forceps MAYO.....	89
STRULLY neuro surgical.....	65	SYSTRUNK surgical scissors.....	66	tissue forceps McPHERSON.....	392
STRUYCKEN nose forceps.....	427	T		tissue forceps MOORFIELD.....	392
SUBRAMANIAN-MINIATURE.....	521	TABB knives.....	418	tissue forceps PAUFIQUE.....	392
suction -/irrigation cannula.....	394	TAKAHASHI nose forceps.....	427	tissue forceps SINGLEY.....	88
suction handle WULLSTEIN.....	338	Tangential clamp DeBAKEY-SATINSKY.....	502	tissue forceps STRASSBURGER MODELL.....	89
suction raspatories GUILLEN.....	433/1	TARNIER cranioplast.....	607	tissue forceps type TUEBINGEN.....	392
suction tube ADSON.....	337	TARNIER obstetrical forceps.....	604	tissue forceps ULTRA LIGHT.....	95
suction tube ANDREW-PYNCHON.....	28	TAYLOR percussion mallet.....	24	tissue forceps WAGENSTEEN.....	89
suction tube BABY-YANKAUER.....	27	TAYLOR SPINAL hook.....	291	tissue forceps YASARGIL.....	97
suction tube BARON.....	336	TAYLOR surgical tissue forceps.....	87	tissue forceps St. MARTIN.....	392
suction tube COOLEY.....	28	TC scissors FREEMAN.....	74	tissue grasping forceps CHAPUT.....	110
suction tube DASTOOR.....	380			tissue grasping forceps COLLIN.....	110

tissue grasping forceps TUFFIER	110	towel clamp BACKHAUS-clip	132	U	
titanium clips	549	towel clamp BALL AND SOCKET	133	UCKERMANN cotton-applicator	203
titanium HALSTED-MOSQUITO hemostatic clamp	105	towel clamp BERNHARD	133	ULRICH bone holding forceps	248
titanium hemostatic clamp CRILE	107	towel clamp DOYEN	133	ULRICH dressing forceps	135
titanium hemostatic clamp KELLY	106	towel clamp JONES	132	Ultra-Light-tissue forceps atrauma	95
titanium tissue forceps DEBAKEY	99	towel clamp JONES-clip	132	umbilical cord COLLIN	605
titanium-ATRAUMA-bulldog clamp	102	towel clamp LANE	133	umbilical cord KANE	605
TOBOLD cotton-applicator	203	towel clamp LORNA	133	umbilical cord scissors BRAUN-STADLER	64
TOBOLD tongue depressors	453	towel clamp MOYNIHAN	133	umbilical cord scissors BUSCH	64
TOENNIS dura dissector	332	towel clamp PEERS	132	umbilical cord scissors SCHUMACHER	64
TOENNIS hemostatic clamp	117	towel clamp ROEDER	132	umbilical cord scissors type USA	64
TOENNIS-ADSON dissecting scissors	65	towel clamp SCHAEDEL	132	UNI I DIAGNOSTIK-BES.	13
TOHUKU towel clamp	132	towel clamp TOHOKU	132	UNI III DIAGNOSTIK-BES.	15
tongue blade DOUGHTY	458	TOWNLEY caliper	26	UNIVERSAL bandage scissors	70
tongue depressors	451	TOWNSEND biopsy forceps	591	UNIVERSAL endoscope assembly	188
tongue depressors ANDREW	452	TOWNSEND MINI biopsy forceps	591	Universal handle HUBER	472
tongue depressors BRUENINGS	451	TOWNSEND TISCHLER MINI biopsy forceps	591	UNIVERSAL sterilization forceps	227
tongue depressors BUCHWALD	451	TOYNBEE ear specula	399	Universal tray	620
tongue depressors DAVIS-BOYLE	455	trachea cannula LUER	479	UNIVERSAL trocar	204
tongue depressors DINGMANN	456	trachea cannula WAGENER-MOSHER	477	UNIVERSAL wire scissors	67
tongue depressors FRENZEL	451	trachea cannula CHEVALIER-JACK	479	UNNA comedone extractor	608
tongue depressors HARTMANN	452	trachea dilator LABORDE	476	Urethrotome OTIS	553
tongue depressors KILNER-DOUGHTY	456	trachea dilator TROUSSEAU	476	US army retractor	141
tongue depressors KROENIG	451	trachea dilator TROUSSEAU-BABY	476	USA anatomic tissue forceps	81
tongue depressors MAYO	451	trachea hook BOSE	476, 477	USA type umbilical cord scissors	64
tongue depressors MORITZ-SCHMIDT	452	trachea hook ITERSON	477	uterine clamp GREEN-ARMYTAGE	605
tongue depressors RING	455	trachea hook JACKSON	476	uterine curette SIMON	594
tongue depressors RUSSEL-DAVIS	458	trachea hook NEWS	477	uterine curette BLAKE	595
tongue depressors TOBOLD	453	Trachoma forceps KNAPP-LUER	393	uterine curette BUMM	597
tongue depressors WIEDER	453	Transformer	22	uterine curette GOURDET	599
tongue forceps COLLIN	452	TRANSFORMER FOR laryngoscope handle	34	uterine curette RECAMIER	597
tongue forceps YOUNG	453	TRAVERS retractors	172	uterine curette SCHRÖDER	595
tonometer SCHIOETZ	394/2	tray	619	uterine curette SIMS	597
tonsil forceps Abraham	468	Tray universal	620	uterine curette THOMAS	599
tonsil elevator HENKE	465	TRELAT tonsil needle	466	uterine depressor BRAUN	586
tonsil elevator HURD	465	TRELAT vaginal specula	571	uterine depressor SIMS	586
tonsil elevator LOPEZ-REINKE	465	trocar COAKLEY	204	uterine Dilatator GOODELL	581
tonsil elevator YANKAUER	465	trocar DOUGLAS	204	uterine Dilatator HANK	580
tonsil forceps BALLENGER	467	trocar LICHTWITZ	204	uterine Dilatator HEGAR	578, 579
tonsil forceps BLOHMKE	467	trocar NELSON	205	uterine Dilatator PRATT	580
tonsil forceps MARSCHIK	468	trocar OCHSNER	205	uterine Dilatator SIMS	581
tonsil forceps NEGUS	467	trocar PIERCE	204	uterine Dilatator WYLIE	581
tonsil forceps SAWTELL	467	trocar UNIVERSAL	204	uterine grasping forceps COLLIN	585
tonsil forceps SCHNIDT	467	trocar Standard (NELSON)	204	uterine grasping forceps DARTIGUES	585
tonsil forceps TYDING	467	TROELTSCH ear forceps	424	uterine grasping forceps SOMER	585
tonsil forceps WHITE	467	TROEMNER percussion mallet	24	uterine polyp forceps DOYEN	585
tonsil grasping forceps COLVER	467	TROUSSEAU trachea dilator	476	uterine polyp forceps KELLY	585
tonsil knives ABRAHAM	466	TROUSSEAU-BABY trachea dilator	476	uterine polyp forceps NOTO	585
tonsil knives BRUENINGS	466	TROUTMAN iris tissue forceps	389	uterine-probes COLLIN	586
tonsil knives CANFIELD	466	TROUTMAN iris tissue forceps	384, 389	uterine-probes MARTIN	586
tonsil knives CARPENTER	465	TROUTMAN-CHRIS bladeBREAKERS	45	uterine-probes SIMS	586
tonsil knives DOUGLAS	466	tubal catheter	596		
tonsil knives FISHER	466	tube milking roller	131	V	
tonsil needle	470	tubing clamp	129	vaginal specula	569
tonsil needle CLAUS	466	tubing clamp HOFFMANN	624	vaginal specula JACKSON	573
tonsil needle DUPUY-WEISS	466	tubing clamp SIMPLEX	624	vaginal specula AUVARD	576
tonsil needle NAGER	466	tubing clamp Bülow-Gunar-Hey	130	vaginal specula BREISKY	577
tonsil needle TRELAT	466	TÜBINGEN IRIS forceps	387	vaginal specula COLLIN	570
tonsil scissors	59	TÜBINGEN tissue forceps	392	vaginal specula CUSCO	570
tonsil scissors BOETTCHER	59	TUFFIER retractor	147	vaginal specula DOYEN	574
tonsil scissors DEAN	59	TUFFIER rib spreader	487	vaginal specula GRAVE	570
tonsil scissors GOOD	59	TUFFIER tissue grasping forceps	110	vaginal specula KRISTELLER	572
tonsil scissors PRINCE	59	Tumor grasping forceps LANDOLT	341/2	vaginal specula LANDAU	577
tonsil snare BRUENINGS	468	Tumortissue forceps YASARGIL	97	vaginal specula PEDERSON	570
tonsil snare EVES	468	tuning forc	404	vaginal specula SCHERBAK	575
tonsil syringe	470	tuning forc HARTMANN	403	vaginal specula SEMM	571
tonsil wire	468	tuning forc LUCAE	404	vaginal specula SIMS	573
tonsilotome SLUDER-BALLENGER	470	tuning forc HADEO	403	vaginal specula TRELAT	571
tonsilotome TYDING	469	tuning forcn RYDEL-SEIFFERT	404	vaginal specula VU-MORE	569
TOOK corneal scarifier	373	TURNBULL nail forceps	609	VALLEIX probes	586
Tourniquet RUMEL-BELMONT	528	TURREL rectal biopsy forceps	567	VAN BUREN bone holding forceps	249
towel clamp	133	TYDING tonsil forceps	467	VAN BUREN dilation bougie	554
towel clamp BACKHAUS	132	TYDING tonsilotome	469	VAN DOREN biopsy forceps	588

VANNAS eye scissors	79	WEBER aorta clamp.....	501	YASARGIL aneurysm	349 - 356
VARADY varix instrument.....	202	WEBER cataract loop	378	YASARGIL GALEAhook.....	330
varicose vein probes NABATOFF	201	WEBSTER needle holder.....	208	YASARGIL suction tube	337/1
varix instrument VARADY	202	WECKER eye scissors	75	YASARGIL tumor tissue forceps.....	97
vascular clamp BAINBRIDGE	495/1, 495/2	WECKER iris spatula.....	378	YEOMAN rectal biopsy forceps	566, 567
vascular clamp COOLEY	518, 522	WEEK eye specula	370	YOUNG BOOMERANG	220
vascular clamp DALE.....	494, 495	WEIL-BLAKESLEY nose forceps	426	YOUNG prostatic hook	550
vascular clamp DARDIK.....	509/1	WEITLANER retractors.....	169	YOUNG tongue forceps	453
vascular clamp DEBAKEY	493-500, 502, 505-508, 512-517	WEITLANER-WULLSTEIN retractors.....	169		
vascular clamp DEBAKEY children	516	WELLER dissecting scissors	53/2	Z	
vascular clamp DEBAKEY-MIXTER.....	499/2	WELLS enucleation curette.....	378	ZAUFAL ear lever	409
vascular clamp DEBAKEY-RUMEL	499	WERTHEIM gynecological scissors	63	ZAUFAL-JANSEN bone rongeur	238
vascular clamp DIEFFENBACH.....	104	WERTHEIM hysterectomy clamp	124, 128	ZAUFAL-JANSEN ear lever	409
vascular clamp GLOVER	515	WERTHEIM hysterectomy scissors.....	63	ZENKER hemostatic clamp.....	118
vascular clamp SATINSKY	491	WERTHEIM-CULLEN hysterectomy clamp.....	125	ZENKER retractor	161
vascular clip BIEMER.....	361	WEST nose chisels.....	442	ZIEGLER discision knives	373
vascular clip MEHDORN	362	WESTCOTT eye scissors	75	ZIEGLER eye specula.....	371
vascular clip MUELLER.....	365	WESTMACOTT nose dressing forceps	424	ZIEGLER head mirror	21
vascular scissors DE BAKKEY.....	61	WESTON rectalsnare.....	566	ZIEGLER iris knives.....	372
vascular scissors DeBaKey TC.....	60	WHEELER cyclodialysis spatula	379	ZIEGLER lachrymal dilator	381
vascular scissors DIETRICH.....	60	WHEELER discision knives	373	ZIELKE gouges.....	264
vascular scissors FAVALORO.....	61	WHITE tonsil forceps.....	467	ZOELLNER suction tube.....	337/1
vascular scissors KELLY.....	61	WIBERG raspatoriesIUM.....	277		
vascular scissors KLINKENBERG-LOTH.....	65/2	width ruler.....	594		
vascular scissors POTTS-DE MARTEL	59	WIEDER tongue depressors.....	452		
vascular scissors POTTS-SMITH.....	61	WIENER antrum rasp	443		
vascular scissors SATINSKY	65/1	WIENER iris hook	375		
vascular tissue forceps ADLERKREUTZ	84	WIGMORE plaster knives.....	229		
vascular tissue forceps NELSON.....	89	WIKSTROEM hemostatic clamp	117		
vascular tissue forcepsSTILLE-BARRAYA	88	WILDE polyp snare	411		
vascular-cannula SCHMID	338	WILDE polyp snare	433/2		
vascular-dilator DEBAKEY	529	WILDE(TROELTSCH) ear forceps	410		
vascular-dissector ROBB	530	WILDER cataract loop	378		
vasectomy clamp.....	553/2	WILDER dilator	381		
VERBRUGGE bone holding forceps	245	WILLET MARTEL grasping forceps.....	110		
VERBRUGGE-MÜLLER bone levers	287	WILLIAMS eye specula	370		
VERESS insufflation cannula.....	206	WILLIAMS intestinal grasping forceps.....	539		
VIENNA guide probes	221/1	WILLIAMS screw driver.....	323		
VIENNA nose specula	421	WILLIGER curette.....	255, 257		
VIRCHOW POST MORTEM knives	48	WILLIGER mallet	271		
VIRTUS(RALK) splinter forceps	92	WILLIGER raspatories	276		
VOLKMANN bone curettes	251	WINTER ovum forceps	606		
VOLKMANN curette	257	wire basket for endoscope	623		
VOLKMANN retractor.....	153	wire cutter HERCULES.....	320/1 - 320/3		
VOLKMANN retractor.....	153, 156	wire dispenser	310		
VOLTOLINI nose specula	421	wire forceps	317 - 320/3		
VU-MORE vaginal specula.....	569	wire forceps BERRY TC.....	319		
		wire forceps CORWIN-HEGAR TC.....	319		
		wire forceps MAYO-HABERISSER TC.....	319		
		wire gauze	311		
		wire grasping forceps.....	318		
		wire guide needle DEMEL	315		
		wire instrument DEMEL	315		
		wire instrument LOUTE	315		
		wiresaw OLIVECRONA.....	332		
		wirescissors UNIVERSAL	67		
		WITTNER biopsy forceps	589		
		WOLFF plaster forceps	233		
		WOODSON dura dissector	333		
		WORST probes	333		
		wound curette ARRUGA	378		
		WRIGLEY obstetrical forceps.....	602		
		WULLSTEIN knives	418		
		WULLSTEIN micro-curette forceps.....	416		
		WULLSTEIN retractors	171		
		WULLSTEIN suction handle.....	338		
		WYLIE aortic clamp	501/1, 501/2		
		WYLIE uterine dilator.....	581		
		Y			
		YANCOSKIE retractor.....	198		
		YANKAUER suction tube.....	27		
		YANKAUER tonsil dissector	465		

Abraham bisturi para amígdalas.....	466
Abraham pinza para coger amígdalas.....	468
abre-boca Davis-Boyle.....	455
abre-boca Davis-Meyer.....	457
abre-boca Denhart.....	454
abre-boca Dingmann.....	456
abre-boca Doughty-Kilner.....	456
abre-boca Doyen-Jansen (Molt).....	454
abre-boca Heister.....	454
abre-boca Jansen-Doyen (Molt).....	454
abre-boca Jennings.....	454
abre-boca Kilner-Doughty.....	456
abre-boca Koenig-Roser.....	454
abre-boca Mclvor.....	457
abre-boca Molt (Doyen-Jansen).....	454
abre-boca Roser-Koenig.....	454
aceite para instrumentos InstruCare.....	635
Adair pinza uterina.....	582
Adams-Mayo separador.....	171
adaptador para iluminación para amnioscopio.....	600
adenotomía LaForce.....	450
Adlerkreutz pinza de disección.....	84
Adson Anderson separador.....	172
Adson Baby pinza hemostática.....	113
Adson elevador.....	282
Adson gancho para dura-madre.....	329
Adson pinza de disección.....	81/2, 82
Adson pinza de protección.....	298
Adson pinza gubia.....	236
Adson pinza hemostática.....	112, 113
Adson pinza para hipofisis.....	334
Adson porta aguja.....	211
Adson separador.....	172-174
Adson tubo de aspiración.....	337
Adson-Beckmann separador.....	175
Adson-Brown pinza de disección.....	82
Adson-DeBakey pinza de disección.....	81/2
Adson-Toennis tijera.....	65
Aebli tijera corneal.....	58
agrafe Michel.....	224
aguja Barbara.....	419
aguja de decisión Bowman.....	374
aguja de guía para anestesia.....	206
aguja de guía Redon.....	207
aguja para amígdalas.....	470
aguja para autopsia.....	268
aguja para biopsia Menghini.....	206
aguja para catarata.....	374
aguja para cuerpos extraños.....	374
aguja para cuerpos extraños Davis.....	374
aguja para cuerpos extraños Francis.....	374
aguja para cuerpos extraños Levinson.....	374
aguja para laringe.....	470
aguja para ligadura.....	218, 219
aguja para ligadura Cooper.....	219
aguja para ligadura Deschamps.....	218
aguja para ligadura Dick-Schmieden.....	219
aguja para ligadura Kronecker.....	219
aguja para ligadura Nelson.....	219
aguja para ligadura Schmieden-Dick.....	219
aguja para neumoperitoneo Verres.....	206
aguja para paracentesis Lucae.....	408
aguja para paracentesis Politzer.....	408
aguja para sutura amígdalas Dupuy-Weiss.....	466
aguja para sutura amígdalas Weiss-Dupuy.....	466
aguja para sutura del paladar Claus.....	466
aguja para sutura del paladar Claus-Eicken.....	466
aguja para sutura del paladar Eicken-Claus.....	466
aguja para sutura del paladar Nager.....	466
aguja pasa-hilo Demel.....	315
aguja Reverdin.....	220
aguja Young Boomerang.....	220
aguas de sutura.....	222, 223
Air Injection canula.....	394
alambre de Kirschner.....	306, 307
alambre de Steinmann.....	307, 308
alambres.....	306-308
Alan-Parks especulo rectal.....	561
Alderdyce elevador.....	282
Alexander cincel.....	259
Alexander gubia.....	259
Alexander periostotomo.....	276
Alexander pinza para biopsia.....	589
Alexander-Matson periostotomo.....	279
alicate corta-uñas.....	609, 612/2-614
alicate corta-uñas Anvil.....	613
alicate cuticular.....	613
alicate Grip.....	316
alicate para cortar uñas Turnbull.....	609
alicates.....	316-318, 320
alicates para alambres.....	317-320/3
alicates para alambres Hercules.....	320/1-320/3
alicates para cortar alambres.....	316-320
Allen pinza para apéndice.....	544
Allis pinza intestinal.....	537
Allis-Adair pinza intestinal.....	537
Allis-Baby pinza intestinal.....	537
Allis-Judd pinza intestinal.....	538
Allis-Lockwood pinza intestinal.....	538
Allis-Thoms pinza intestinal.....	538
Allison espátula pulmonar.....	489/2
Allis-Thoms pinza intestinal.....	538
Alm separador.....	168
Alvis cureta para cuerpos extraños.....	374
amigdalotomía Sluder-Ballenger.....	470
amigdalotomía Tyding.....	469
amniotomo.....	586, 600
amniotomo Beacham.....	586
Ansler-Connin marcador.....	380
Anderson Adson separador.....	172
Anderson separador.....	198
Anderson-Neivert cincel nasal.....	442
Andrew baja-lengua.....	452
Andrew-Pynchon tubo de aspiración.....	28
Anestrophon estetoscopio.....	23
anillo para Kleinsasser.....	36
anoscopio Chelsea-Eaton.....	563
anoscopio Hirschmann.....	562
anoscopio Ives-Fansler.....	562
anteojos para nistagmo Frenzel.....	20
Antrum cureta.....	435
Anvil alicate corta-uñas.....	613
aparato para suturar estómago e intestinos V. Petz.....	549
aproximador de Biemer.....	366
aproximador de Biemer-Müller.....	363
aproximador de Müller.....	364
aproximador de Müller-Biemer.....	363
aproximador para costillas Baby-Bailey.....	489/1
aproximador para costillas Bailey.....	489/1
aproximador para costillas Bailey-Baby.....	489/1
aproximador para costillas Bailey-Gibbon.....	489/1
aproximador para costillas Gibbon-Bailey.....	489/1
aproximador para costillas Sellors.....	489/1
Archer pinza para espaldas.....	92
Arit asa.....	378
Armytage-Green pinza para útero.....	605
Arruga blefarostato.....	370
Arruga gancho para extracción.....	375
Arruga pinza capsular.....	391
Arruga porta aguja.....	214
Arruga protector.....	378
Arruga-Gill pinza capsular.....	390
Arruga-Kalt pora aguja.....	214
Arthur-Kirby pinza para fijación.....	385
articulación para Kleinsasser.....	36
asa Arit.....	378
asa Billeau.....	409
asa Langenbeck.....	409
asa Shapleigh.....	410
asa Snellen.....	378
asa Weber.....	378
asa Wilder.....	378
Asch pinza para enderezar el tabique nasal.....	449
Aufranc-Cobra separador.....	289
Aufricht lima nasal.....	443
Aufricht retractor nasal.....	447
Auvard especulo vaginal.....	576
Axenfeld cucharilla para chalazión.....	377
Axenfeld-Mellinger blefarostato.....	370
Ayer pinza para ligadura.....	393
B	
Babcock pinza intestinal.....	539
Babinsky martillo de percusión.....	24
Baby Balfour separador abdominal.....	182, 183
Baby Burke pinza para biopsia.....	590
Baby Gosset separador abdominal.....	181
Baby Lexer tijera de disección.....	53
Baby Melzenbaum tijera supercut.....	71
Baby Mixter pinza hemostática.....	119/1
Baby Roux separador.....	140
Baby-Bailey aproximador para costillas.....	489/1
Baby-Doyen pinza intestinal.....	540
Baby-Kocher pinza intestinal.....	540
Baby-Olsen-Hegar porta aguja.....	212
Baby-Overholt pinza hemostática.....	114
Baby-Payr pinza intestinal y estomacal.....	548
Babington esfigmomanómetro.....	10
Baby-Tischler pinza para biopsia.....	592
Baby-Trousseau dilatador traqueal.....	476
Baby-Yankauer tubo de aspiración.....	27
Back holder separador abdominal.....	192-195
Backhaus pinza de campo.....	132
Backhaus-Clip pinza de campo.....	132
Bahnsen-DeBakey pinza para aneurisma.....	506
Bailey aproximador para costillas.....	489/1
Bailey-Baby aproximador para costillas.....	489/1
Bailey-Gibbon aproximador para costillas.....	489/1
Bainbridge pinza hemostática.....	119/2
Bainbridge pinza vascular de uso múltiple.....	495/1-495/2
baja-lengua Andrew.....	452
baja-lengua Bruenings.....	451
baja-lengua Buchwald.....	451
baja-lengua Cawood-Minnesota.....	451
baja-lengua Davis-Russel.....	458
baja-lengua Doughty.....	458
baja-lengua Frenzel.....	451
baja-lengua Hartmann.....	452
baja-lengua Koenig.....	451
baja-lengua Mayo.....	451
baja-lengua Minnesota-Cawood.....	451
baja-lengua Moritz-Schmidt.....	452
baja-lengua Ring.....	455
baja-lengua Russel-Davis.....	458
baja-lengua Schmidt-Moritz.....	452
baja-lengua Tobold.....	453
baja-lengua Wieder.....	452
baja-lenguas.....	451-453, 455
Bakes dilatador para conductos biliares.....	532
Balfour Baby separador abdominal.....	182, 183
Balfour separador abdominal.....	182, 183
Balfour-US separador abdominal.....	184
Ball and Socket pinza para campo.....	133
Ballenger cuchillo para tabique nasal.....	436
Ballenger elevador para el tabique nasal.....	439
Ballenger pinza para coger amígdalas.....	467
Ballenger-Hajak elevador para el tabique nasal.....	439
Ballenger-Sluder amigdalotomía.....	470
Ballentine-Heany pinza para histerectomía.....	127
bandejas.....	620

Bane-Hartmann pinza gubia	237	Blake pinza para calculos biliares	530/2	Brown pinza de diseccion	83
Bangerter espátula para ciclodialisís	379	Blake-Mayo pinza para calculos biliares	530/2	Brown porta aguja	209
Baracani punta de pinza	472	Blakesley-Well pinza nasal	426	Browne-Denis separador abdominal	185
Barany ensordecedor	405	blefarostato Arruga	370	Bruenings baja-lengua	451
Barbara aguja	419	blefarostato Axenfeld-Mellinger	370	Bruenings bisturí para amígdalas	466
Barbara gancho	419	blefarostato Barraquer (Colibri)	370	Bruenings cierranudos	468
Barbon-Lubet pinza nasal	424	blefarostato Bowman	370	Bruenings espejuelo auricular	401
Barkan cuchillo para goniotomía	373	blefarostato Burch-Lister	370	Bruenings pinza nasal	425
Barnhill cuchillo para vegetaciones adenoides	450	blefarostato Clark	370	Bruenings punta de pinza	472
Baron canula de succión	336	blefarostato Colibri (Barraquer)	370	Bruenings tubo de extensión	472
Barr espejuelo rectal	559	blefarostato Critchett	370	Brunetti cincel	268
barra de tracción Gerster	250	blefarostato Graefe	370	Brünings-Lucas cincel	260
Barraquer (Colibri) blefarostato	370	blefarostato Lancaster	371	Brünings-Lucas gubia	260
Barraquer (Colibri) pinza para iris	384	blefarostato Lister-Burch	370	Brunner costotomo	481
Barraquer Colibri tijera para oftalmología	75	blefarostato Mellinger	370	Brunner pinza intestinal	543
Barraquer cuchillo para queratoplastica	373	blefarostato Mellinger-Axenfeld	370	Brunner separador	167
Barraquer micro porta aguja	216, 217	blefarostato Murdock	370	Brunner sonda conductora	221, 221/1
Barraquer pinza depilatoria	395	blefarostato Smith	370	Bruns cucharilla cortante	251, 254
Barraquer pinza para fijación	390	blefarostato Week	370	Bruns tijera para vendaje	70
Barraquer-Katzin pinza para iris	384	blefarostato Williams	370	Bryant pinza para medicación	137
Barraquer-Troutmann micro porta aguja	216	blefarostato Ziegler	371	Buchwald baja-lengua	451
Barraquer-Stille pinza de disección	88	blefarostato Castroviejo	371	Buck cureta	407
Barrett pinza uterina	582	blefarostato Liebermann	371	Buck elevador para cuerpos extraños	412
Barton forceps obstétrico	603/2	blefarostato Mueller	371	Buck martillo de percusión	24
Barton tractor	603/2	blefarostato Park	371	Buck-Gramcko elevador	285
Baumgartner porta aguja	208	blefarostato Stevenson	371	Buie canula de aspiración rectal	566
Beacham amiotomo	586	Blohmke pinza para coger amígdalas	467	Buie-Smith separador rectal	561
Bechert rotador	379	Blount elevador	288	bujía dilatadora Dittel	554
Beck pinza para anastomosis	516, 520	Blount separador para rodilla	289	bujía dilatadora Guyon	554
Becker quistotomo	375	Blumenthal pinza gubia	236	bujía dilatadora Van Buren	554
Beckmann-cuchillo para vegetaciones adenoides	450	Bodenhammer espejuelo rectal	559	Bülow-Gunar-Hey pinza tierra-tubo	130
Beckmann separador	176	Boerma forceps obstétrico	604	Bumm cureta uterina	597
Beckmann-Adson separador	175	Boettcher tijera para amígdalas	59	Bunell pasador de tendones	294
Beckmann-Eaton separador	176	Böhler estribo para extensión	312	Bunell perforador de mano	299
Beer pinza depilatoria	395	Böhler pinza cortante para huesos	241	Bunell separador para tendones	292
Beeson separador para yesos	232	Böhler pinza gubia	238	Bunge cucharilla para exenteración	378
Bellucci tijera auricular micro	413, 417	Boies elevador	277	Bunt clip para esterilización	227, 624
Belmont-Rumel tourniquet	528	bomba de aire	29, 30	Burch horquilla fijadora	373
Bengolea pinza hemostática	112	bombilla de repuesto para laringoscopio	29, 30	Burch-Lister blefarostato	370
Bennett elevador	283	bombonas	621	Burford-Finochietto separador costal	483
Bensaude protoscopio	565	Bonaccolto pinza para estrabismo	385	Burke pinza para biopsia	590
Benson separador para piloro	544	Bonn Mod. pinza para sutura	386	Burrows-Jackson separador	189/2
Berens cuchillo de discisión	372	Bonn pinza para sutura	386	Busch tijera para cordón umbilical	64
Bergmann martillo	272	Bonney pinza de disección	88	Bushe cucharilla cortante	256
Bergmann tijera para vendaje	69/1	Boomerang Young aguja	220		
Bergmann-Schulze espejuelo rectal	560	Boomerang Young porta aguja	220		
Berke pinza muscular	389	Bose gancho para traqueotomía	477		
Berlin Klinikum pinza tierra-tubo	129	Bose separador traqueal	476		
Berliner martillo de percusión	24	Boucheron espejuelo auricular	399		
Bernhard pinza de campo	133	Bowman aguja de discisión	374		
Berry pinza para torcer hilo	319	Bowman blefarostato	370		
Bethune costotomo	481	Bowman sonda lacrimal	381		
Beyer pinza gubia	237, 238	Boyle-Davis abre-boca	455		
Biemer aproximador	366	Boynton porta aguja	214		
Biemer pinza para vasos	361	Boys-Allis pinza intestinal	538		
Biemer-Müller aproximador	363	Bozemann pinza porta esponja	138		
Bier sierra para amputación	296	Bozemann porta aguja	211		
Bill tractor	604	Bozemann-Douglas pinza porta esponja	138		
Billeau asa	409	Brand mondador de tendones	294		
Bill-Luikart tractor	604	Brand pinza de agarre para tendones	293		
Bircher-Ganske pinza para hueso	246	Braun cranioclasto	607		
Birkett pinza hemostática	116	Braun depresor uterino	586		
Bishop-Harman pinza para iris	386	Braun gancho de decapitación	607		
Bishop-Harmon canula de irrigación y aspiración	394/1	Braun pinza uterina	582		
bisturí nasal Joseph	434, 435	Braun-Stadler tijera para episiotomía	64		
bisturí para amígdalas Abraham	466	Braun-Stadler tijera para episiotomía	64		
bisturí para amígdalas Bruenings	466	brazalete para brazo	295		
bisturí para amígdalas Canfield	466	brazalete para femur	295		
bisturí para amígdalas Douglas	466	Breast separador mamario	198		
bisturí para amígdalas Fisher	466	Breisky espejuelo vaginal	577		
bisturí para fibroma Segond	594	Bridge pinza hemostática	116		
bisturíes	46	Bristow elevador	290		
Blake cureta uterina	595	Brodie sonda acanalada	199		
		Brophy pinza de disección	84		

C

caja para esterilización	618
caja para instrumentos	617
calibrador decimal Iwanson	624
calibre	26
calibre Townley	26
Canfield bisturí para amígdalas	466
canula Air Injection	394
canula capsular Jensen	394
canula de aspiración para mango de Wullstein	337/1
y Zöllner	566
canula de aspiración rectal Buie	337/1
canula de aspiración para mango de Zöllner	337/1
y Wullstein	36
canula de inyección Kleinsasser	394/1
canula de irrigación y aspiración Bishop-Harmon	394/1
canula de irrigación y aspiración Harmon-Bishop	394/1
canula de succión Baron	336
canula de succión Kleinsasser	36
canula irrigación Eicken (Killian)	433
canula irrigación Killian (Eicken)	433
canula Killian	433/1
canula Lacrimal	394
canula lacrimal McIntyre	394
canula para lavador vascular Schmid	338
canula para traqueotomía Chevalier-Jackson	479
canula para traqueotomía Jackson-Chevalier	479
canula para traqueotomía Luer	479

canula para traqueotomía Mosher-Wagener.....	477	cincel nasal Rubin	440	Collin separador	139
canula para traqueotomía Wagener-Mosher.....	477	cincel nasal Sheehan	441	Collin separador abdominal	190
canula Sheets.....	394/2	cincel nasal Silver.....	442	Collin-Duval pinza de disección.....	85
canula Simcoe.....	394/2	cincel nasal West	442/1	Collin-Farabeuf periostotomo	274
Carmalt pinza para espinas.....	91	cincel para cuerpos extraños Dix	374	Collin-Hartmann separador	141
Carmalt-Rochester pinza hemostática.....	109	cincel para el tabique nasal Freer	439	Collins-Mayo separador	141
Caroli pinza de agarre para tendones.....	293	cincel para extirpación Rollet.....	374	Colver pinza para coger amígdalas	467
Carpenter cuchillo para amígdalas	465	cincel Partsch.....	259	compas marcador Castroviejo	380
Cartilage-Martin tijera.....	65/1	cincel Petersen-Smith	261	Cone pinza sacabocado craneal.....	331
Caspar hemostático	258	cincel rompe-craneo	267	Connin-Amsler marcador	380
Caspar separador.....	179	cincel Smith-Petersen	261	Contour-Scalp separador.....	169
Castaneda pinza vascular para neonatales	527	cincel Stille	260	Converse cuchillo rinoplástico	435
Castroviejo blerarostato	371	cincel tamponador para huesos Passow.....	260	Converse separador.....	448
Castroviejo compas marcador	380	Cinelli cincel nasal	441	Cooley pinza traumática.....	99
Castroviejo cuchillo para disección	372	Circumflex micro tijera	76	Cooley pinza para anastomosis.....	519-520/1, 520/4
Castroviejo dilatador lacrimal.....	381	Citelli pinza sacabocado	430	Cooley pinza para aorta	520/3
Castroviejo espátula para ciclodialisis	379	cizalla para yesos Stille	229	Cooley pinza para cateter	510
Castroviejo pinza capsular	391	clamp trauma bulldog	100	Cooley pinza vascular	520
Castroviejo pinza para fijación	390	clamp trauma bulldog DeBaKey.....	100, 103	Cooley pinza vascular de uso múltiple.....	518-520, 520/2
Castroviejo pinza para sutura	392	clamp trauma bulldog Glover	100, 103	Cooley pinza vascular pediátrica	522
Castroviejo porta aguja	215	clamp bulldog de Titario	102	Cooley separador	148
Castroviejo rompe hojas	45	clamp bulldog DeBaKey-Dietrich	101	Cooley separador costal	485, 487
Castroviejo tijera para corneales.....	79	clamp bulldog Dietrich	101	Cooley-Derra pinza para anastomosis.....	519
Castroviejo tijera para iridectomía.....	79	clamp bulldog Dietrich-DeBaKey	101	Cooper aguja para ligadura.....	219
Castroviejo-Micro porta aguja.....	215	clamp umbilical Collin	605	copas graduadas.....	620
Castroviejo-Standard micro porta aguja	216	clamp umbilical Kane	605	Cordes punta de pinza.....	472
cateter auricular Hartmann.....	408	Clar lámpara frontal.....	22	Coronal Blow Lift separador	198
cateter Coxeter.....	555	Clark blefarostato	370	Corwin-Hegar pinza para torcer hilo	319
cateter metálicos.....	555	Claus aguja para sutura del paladar	466	Coryllos (Thorax) separador	166
cateter Walther	555	Claus-Eicken aguja para sutura del paladar	466	Coryllos costotomo	480
Catlin cuchillo para amputación.....	44	Claus-Killian cincel nasal	442/1	Cos pinza auricular micro.....	414
cauterio Todd-Wadsworth.....	378	Clayman gancho	376	costotomo	480, 481
cauterio Wadsworth-Todd	378	Cleveland pinza gubia	235	costotomo Bethune	481
Cawood-Minnesota baja-lengua.....	451	clip para esterilización Bunt	227, 624	costotomo Brunner	481
cepillo para uñas.....	611	clip para esterilización Mayo	227, 624	costotomo Coryllos	480
cesta de esterilización	622, 623	Clip-Jones pinza de campo	132	costotomo Frey-Sauerbruch	481
Chandler elevador	282	clips para aneurisma Yasargil	345-356	costotomo Giertz-Stille.....	481
Chaput pinza hemostática	110	clips para vasos de Müller	365	costotomo Gluck.....	480
Charnley separador abdominal	289	Cloward pinza cortante para laminectomía	342	costotomo Sauerbruch.....	481
Charniere sierra para amputación	296	Cloward separador	178/1-178/4	costotomo Sauerbruch-Frey	481
Cheatle pinza para esterilización	227	Cloward separador para cuerpo vertebral	339	costotomo Stille	480
Chelsea-Eaton anoscopio.....	563	Cloward separador para tejido cervical	339	costotomo Stille-Giertz.....	481
Cheron pinza porta esponja	137	coagulación bipolar	628-633	Cottle (Maltz) lima nasal	444
Cherry separador para laminectomía.....	488	Coakley cureta para seno	449	Cottle cincel nasal	440
Chevalier-Jackson canula para traqueotomía	479	Coakley trocar para seno maxilar	204	Cottle cuchillo rinoplástico.....	435
Chevalier-Jackson pinza para bronco-esofagoscopia.....	473	Cobb cureta.....	252	Cottle elevador para el tabique nasal	439
Cheyne-Watson disecador.....	199	Cobb gubia.....	262	Cottle especulo nasal	423
Cheyne-Watson elevador	283	Cobb periostotomo	280	Cottle gancho para la piel.....	448
Childe pinza para aplicar agrafes.....	224	Cobra-Aufranc separador	289	Cottle Joseph elevador para el tabique nasal	439
cierra-nudo auricular Krause	411	Colclough pinza sacabocado para discos		Cottle martillo	273
cierra-nudo auricular Wilde	411	intervertebral	344/1	Cottle pinza para columna	448
cierra-nudo rectal Yeoman	566	Colibri (Barraquer) blefarostato	370	Cottle pinza para fijación.....	410
cierranudos Bruenings	468	Colibri (Troutman) pinza para iris.....	384	Cottle retractor nasal	447, 447/1
cierranudos Eves	468	Colibri Barraquer tijera para oftalmología	75	Cottle tijera nasal.....	59
cierra-tubos Hoffmann	624	Colibri pinza para iris.....	384	Cottle tijera para cirugía.....	56
cierra-tubos Simplex.....	624	College-London pinza dental	93	Cottle-Kazanjian pinza cortante para huesos.....	241
cincel	259-261, 264-265	Coller-Crile pinza hemostática	106	Cottle-Neivert gancho para la piel	448
cincel Alexander	259	Collier pelvimetro.....	605	Coxeter cateter.....	555
cincel Brunetti	268	Collier porta aguja	208	Crafoord pinza hemostática	118
cincel Brünings-Lucas.....	260	Collin clamp umbilical	605	Crafoord tijera pulmonar	65/2
cincel de esternon Lebsche.....	267	Collin dinamómetro	25	Crafoord-Sellers pinza hemostática.....	119
cincel Hibbs.....	265	Collin especulo vaginal	570	cranioclasto Braun	607
cincel Lucas-Brünings.....	260	Collin histerometro	586	cranioclasto Tarnier	607
cincel nasal Anderson-Neivert	442	Collin Loktite separador abdominal	191	Crego elevador	282
cincel nasal Cinelli.....	441	Collin mango de bisturí.....	40	Crile gancho para nervio	328
cincel nasal Claus-Killian	442/1	Collin martillo	270	Crile pinza hemostática.....	107
cincel nasal Cottle	440	Collin pelvimetro	605	Crile porta aguja	213
cincel nasal Fomon	441	Collin pinza hemostática	110	Crile separador.....	140
cincel nasal Freer	442/1	Collin pinza para el útero	585	Crile-Coller pinza hemostática	106
cincel nasal Hajek	442/1	Collin pinza para quitar agrafes	224	Crile-Murray porta aguja	209
cincel nasal Killian	442/1	Collin pinza para tejido	539	Crile-Rankin pinza hemostática	107
cincel nasal Killian-Claus	442/1	Collin pinza porta esponja.....	137	Crile-Wood porta aguja	209
cincel nasal Neivert-Anderson	442	Collin pinza tira-lengua.....	453	Critchett blefarostato.....	370

Crutchfield perforador inicial.....	327	cuchillo para reseccion.....	47	Davis-Boyle abre-boca.....	455
Crutchfield pinza de traccion craneal.....	327	cuchillo para reseccion Langenbeck.....	47	Davis-Meyer abre-boca.....	457
cubeta para placenta.....	621/1	cuchillo para tabique nasal Ballenger.....	436	Davis-Russel baja-lengua.....	458
cubeta Petri.....	620	cuchillo para tabique nasal Freer.....	434	Day gancho auricular.....	409
cubetas.....	619-621/1	cuchillo para vegetaciones adenoides Barnhill.....	450	Dean cuchillo para iris.....	372
cuchara medicinal.....	268	cuchillo para vegetaciones adenoides Beckmann.....	450	Dean tijera para amigdalas.....	59
cuchara para calculos biliares Desjardins.....	534	cuchillo para vegetaciones adenoides St.Clair-Thomson.....	450	Deaver separador.....	145, 146
cuchara para calculos biliares Fergusson.....	533	cuchillo para vegetaciones adenoides Thomson-St.Clair.....	450	Deaver tijera de diseccion.....	52
cuchara para calculos biliares Koerte-Luer.....	533	cuchillo para vendaje enyesado Esmarch.....	233	Deaver-Grip separador.....	146
cuchara para calculos biliares Luer-Koerte.....	533	cuchillo para vendaje enyesado Hopkins.....	233	DeBaKey clamp atrauma bulldog.....	100, 103
cuchara para calculos biliares Mayo.....	534	cuchillo para vendaje enyesado Reiner.....	233	DeBaKey dilatador vascular.....	529
cuchara para calculos biliares Moor.....	531	cuchillo para vendaje enyesado Wigmore.....	229	DeBaKey pinza atraumatica.....	98, 99
cuchara y gancho Gross.....	409	cuchillo Plester.....	418	DeBaKey pinza para anastomosis.....	505, 515
cucharilla cortante.....	251-257	cuchillo rinoplastico Converse.....	435	DeBaKey pinza para aneurisma de la aorta.....	496-498
cucharilla cortante Bruns.....	251, 254	cuchillo rinoplastico Cottle.....	435	DeBaKey pinza para ligadura.....	493, 499-500
cucharilla cortante Bushe.....	256	cuchillo Rosen.....	418	DeBaKey pinza para vasos perifericos.....	494
cucharilla cortante Daubenspeck.....	255	cuchillo Schuhknecht.....	418	DeBaKey pinza vascular.....	
cucharilla cortante Halle.....	253	cuchillo Tabb.....	418	de uso multiple.....	495/2, 507, 508, 514, 515
cucharilla cortante Jacobson.....	257	cuchillo Wulstein.....	418	DeBaKey pinza vascular pediatrica.....	516, 517
cucharilla cortante Jansen.....	257	Cullen-Wertheim pinza para histerectomia.....	125	DeBaKey porta aguja.....	210
cucharilla cortante Lempert.....	256	cureta Antrum.....	435	DeBaKey separador.....	189/1
cucharilla cortante Martini.....	257	cureta aspiradora.....	600	DeBaKey tijera.....	60
cucharilla cortante Hadeo.....	256	cureta aspiradora para biopsia uterina Novak.....	587	DeBaKey tijera vascular.....	61
cucharilla cortante Schede.....	251	cureta aspiradora para biopsia uterina Randall.....	587	DeBaKey-Bahnsen pinza para aneurisma.....	506
cucharilla cortante Scoville.....	253	cureta Buck.....	407	DeBaKey-Dietrich clamp bulldog.....	101
cucharilla cortante Spinal.....	253	cureta Cobb.....	252	DeBaKey-Mixer pinza para ligaduras.....	499/2
cucharilla cortante Spratt.....	251	cureta Faulkner.....	449	DeBaKey-Morris pinza para la aorta.....	506
cucharilla cortante Volkmann.....	251, 257	cureta House.....	420	DeBaKey-Mosquito pinza hemostatica.....	509
cucharilla cortante Williger.....	255, 257	cureta para aborto Pestalozza.....	606	DeBaKey-Pean pinza hemostatica atraumatica.....	513
cucharilla para aborto Cuzzi.....	606	cureta para biopsia Heany.....	587	DeBaKey-Rankin pinza hemostatica atraumatica.....	512
cucharilla para aborto Wallich.....	607	cureta para biopsia Kevorkian.....	587	DeBaKey-Rumel pinza para ligaduras.....	499
cucharilla para cataratas Daviel.....	377	cureta para biopsia Mod. Muenchen.....	587	DeBaKey-Satinsky pinza para oclusion tangencial.....	502
cucharilla para cataratas Graefe.....	377	cureta para biopsia Muenchen Mod.....	587	DeBaKey-Semb pinza para ligadura y la aorta.....	499
cucharilla para cataratas Knapp.....	378	cureta para cuerpos extraños Alvis.....	374	DeBoer separador costal.....	486
cucharilla para chalazion Axenfeld.....	377	cureta para hipofisis.....	334	Decker pinza cortante para laminectomia.....	341
cucharilla para chalazion Hebra.....	377	cureta para hipofisis Ray.....	334	dedal.....	311
cucharilla para chalazion Meyhoefer.....	377	cureta para lupus Piffard.....	608	Dejnerne martillo de percusion.....	24
cucharilla para exenteracion Bunge.....	378	cureta para seno Coakley.....	449	Delee especulo vaginal.....	574
cucharilla uterina Simon.....	594	cureta uterina Blake.....	595	DeLee forceps obstetrico.....	602
cucharra para sangre.....	268, 621	cureta uterina Bumm.....	597	DeMartel guia conductora.....	330
cuchillo auricular Politzer.....	408	cureta uterina Gourdet.....	599	DeMartel-Wolfson pinza para anastomosis.....	546
cuchillo auricular Sexton.....	408	cureta uterina Recamier.....	597	DeMartel-Wolfson pinza para cerrar clamps.....	546
cuchillo corneal Elschnig.....	373	cureta uterina Schröder.....	595	DeMartel-Wolfson porta-clamps.....	546
cuchillo corneal Gill.....	373	cureta uterina Sims.....	597	Demel aguja pasa-hilo.....	315
cuchillo corneal Took.....	373	cureta uterina Thomas.....	599	Demel tensor de cierra-hilo.....	315
cuchillo de discision Berens.....	372	Cusco especulo vaginal.....	570, 571	Denhart abre-boca.....	454
cuchillo de discision Jaeger.....	372	Cushing espátula cerebral.....	336, 369	Denis-Browne separador abdominal.....	185
cuchillo de hoz Hadeo.....	435	Cushing gancho para nervio.....	328	depressor para epiglotis Reichert.....	471
cuchillo interoseo.....	44	Cushing pinza cortante para laminectomia.....	340	depressor uterino Braun.....	586
cuchillo para amigdales Carpenter.....	465	Cushing pinza de diseccion.....	83	depressor uterino Sims.....	586
cuchillo para amputacion Catlin.....	44	Cushing separador.....	151- 153	Derf porta aguja.....	208
cuchillo para amputacion Langenbeck.....	44	Cushing-Taylor pinza de diseccion.....	87	dermatomo Humby.....	50
cuchillo para amputacion Liston.....	44	Cuzzi cucharilla para aborto.....	606	dermatomo Schink.....	49
cuchillo para amputacion Hadeo.....	44	Czerny especulo rectal.....	559	dermatomo Silver.....	50
cuchillo para autopsia.....	48	Czerny pinza uterina.....	584	dermatomo Watson.....	50
cuchillo para autopsia Virchow.....	48	Czerny separador.....	141	Derra pinza para anastomosis.....	515
cuchillo para cataratas Deutschmann.....	371	D		Derra-Cooley pinza para anastomosis.....	519
cuchillo para cataratas Graefe.....	371	Dale pinza para vasos perifericos.....	494, 495	D'Errico separador para la raiz de nervios.....	329/2
cuchillo para cerebro Virchow.....	48	Dandy gancho para nervio.....	328	Deschamps aguja para ligadura.....	218
cuchillo para discision Wheeler.....	373	Dandy pinza hemostatica.....	109	Desjardins cuchara para calculos biliares.....	534
cuchillo para discision Castroviejo.....	372	Dardik pinza vascular.....	509/1	Desjardins explorador para calculos biliares.....	531
cuchillo para discision Graefe.....	372	Darling separador.....	178	Desjardins pinza hemostatica.....	121
cuchillo para discision Ziegler.....	373	Dartigues pinza para el utero.....	585	Desjardins pinza para calculos biliares.....	530/2
cuchillo para falanges.....	44	Dastoor pinza para estrabismo.....	386	Desmarres pinza para chalazion.....	393
cuchillo para goniotomia Barkan.....	373	Daubenspeck cucharilla cortante.....	255	Desmarres separador.....	151
cuchillo para goniotomia Scheie.....	373	Davidson (Scapula) separador.....	166	desoblitador de vena.....	202
cuchillo para iris Dean.....	372	Daviel cucharilla para cataratas.....	377	destornillador.....	323, 324
cuchillo para iris Knapp.....	372	Davis aguja para cuerpos extraños.....	374	destornillador Lane.....	323, 324
cuchillo para iris Ziegler.....	372	Davis elevador para duramadre.....	332	destornillador Williams.....	323
cuchillo para organos.....	48	Davis espátula cerebral.....	337	Deutschmann cuchillo para cataratas.....	371
cuchillo para periestio.....	47	Davis pinza para esterilizacion de jeringas.....	227	Devilbiss pinza sacabocado craneal.....	332
cuchillo para queratoplastica Barraquer.....	373			diapason Hartmann.....	403
cuchillo para queratoplastica Paufigue.....	373			diapason Hadeo.....	403

diapason Lucae	404	Dupuy-Weiss aguja para sutura amigdalas	466	elevador para el tabique nasal Joseph Cottle	439
diapason Rydel-Seiffert	404	Durante pinza de diseccion	88	elevador para el tabique nasal Killian	438, 439
diapason Seiffert-Rydel	404	Duval pinza de diseccion	85	elevador para el tabique nasal Masing	437
diaposones	403, 404	Duval pinza para tejido	539	elevador para el tabique nasal McKenty	437, 438
Dick-Schmieden aguja para ligadura	219	Duval-Collin pinza de diseccion	85	elevador para el tabique nasal Pennington	438
Dieffenbach serra-fina	104			elevador para el tabique nasal Pierce	438
Dieter pinza auricular micro	414	E		elevador para el tabique nasal Roger	437
Dietrich clamp bulldog	101	Eastman-Richardson separador	142	elevador Sayre	281
Dietrich pinza para la aorta	510	Eaton-Chelsea anoscopio	563	elevador Threthowan Lane	290
Dietrich tijera vascular	60	Echlin pinza gubia	240	elevador Verbrugge-Müller	286/2
Dietrich-DeBakey clamp bulldog	101	ECO "T" y "C" estuche de diagnostico	16	elevador Watson-Cheyne	283
dilatador lacrimal Castroviejo	381	Eicken (Killian) canula irrigacion	433	Elliot forceps obstetrico	603
dilatador lacrimal Wilder	381	Eicken-Claus aguja para sutura del paladar	466	Ellis gubia para cuerpos extraños	374
dilatador lacrimal Ziegler	381	electrocirugia	628-634	Elschnig cuchillo corneal	373
dilatador para conductos biliares Bakes	532	elevador	281-291	Elschnig espátula para ciclodialis	379
dilatador para el seno Halle-Ritter	433	elevador Adson	282	Elschnig pinza capsular	391
dilatador para el seno Ritter-Halle	433	elevador Alderdyce	282	Elschnig pinza para fijacion	389
dilatador traqueal Baby-Trousseau	476	elevador auricular Jansen-Zaufal	409	Emmet gancho para fistulas	594
dilatador traqueal Laborde	476	elevador auricular Zaufal	409	Empujador de alambres Erich	461/2
dilatador traqueal Trousseau-Baby	476	elevador auricular Zaufal-Jansen	409	Engel sierra para vendajes enyesados	229
dilatador uterino Goodell	581	elevador Bennett	283	ensordecedor Barany	405
dilatador uterino Hank	580	elevador Blount	288	Enucleation tijera	58
dilatador uterino Hegar	578, 579	elevador Boies	277	Epker osteotomo	464/2
dilatador uterino Pratt	580	elevador Bristow	290	Eppendorfer pinza para biopsia	590
dilatador uterino Sims	581	elevador Buck-Gramcko	285	Erich empujador de alambres	461/2
dilatador uterino Wylie	581	elevador Chandler	282	escariador	304
dilatador vascular DeBakey	529	elevador Cheyne-Watson	283	escariador Perthes	304
dinamómetro Collin	25	elevador Crego	282	esclerotomo Guyton-Lundsgaard	373
Dingman elevador	463/3	elevador Dingman	463/3	esclerotomo Lundsgaard	373
Dingman periostotomo	463	elevador Gramcko-Buck	285	esclerotomo Lundsgaard-Guyton	373
Dingmann abre-boca	456	elevador Hohmann	284, 285	escofina nasal Miller	444
Dingmann pinza para hueso	246	elevador Hohmann Mini	286	escofina nasal Peet	446
Diplomat esfigmomanómetro	5	elevador Hohmann-Lange	286	escofina nasal Wiener	443
disecador Cheyne-Watson	199	elevador Key	282	escupidora	621/1
disecador corneal Green	374	elevador König	284	esfigmomanómetro Babyphon	10
disecador corneal Paton	373	elevador Lane	290	esfigmomanómetro Diplomat	5
disecador para el saco lacrimal Lang	378	elevador Lane Threthowan	290	esfigmomanómetro Exacta-Spezial	8
disecador vascular Robb	530	elevador Lane-Murphy	283	esfigmomanómetro Minimus II	11
disecador Watson-Cheyne	199	elevador Lange-Hohmann	286	esfigmomanómetro Minimus III	12
disector Fisch	420	elevador Lempert	420	esfigmomanómetro Nova	7
disector Gorney	277	elevador Masing	437	esfigmomanómetro Nova-Presameter	6
dispensador de cepillos	611	elevador McDonald	283	esfigmomanómetro Precisa	9
dispensador para brocas filiformes	310	elevador Mini Hohmann	286	esfigmomanómetro Presameter-Nova	6
Dittel bujia dilatadora	554	elevador Müller-Verbrugge	286/2	esfigmomanómetro Spezial-Exacta	8
Dix cincel para cuerpos extraños	374	elevador Murphy-Lane	283	Esmarch cuchillo para vendaje enyesado	233
Dix instrumento para cuerpo extraños	380	elevador Obwegeser	461/1	Esmarch tijera para vendaje	69/2
Doren pinza para biopsia	588	elevador para amigdalas Reinke-Lopez	465	Esmarch vendaje de compresion	296
Doughty baja-lengua	458	elevador para amigdales Henke	465	espátula	143/1-144, 203, 336-337,
Doughty-Kliner abre-boca	456	elevador para amigdales Hurd	465369, 378-379, 489/2, 530, 552, 612/1	
Douglas bisturi para amigdalas	466	elevador para amigdales Lopez-Reinke	465	espátula abdominal Haberer	143/3
Douglas pinza depilatoria	395	elevador para amigdales Yankauer	465	espátula abdominal Kader	143/3
Douglas trocar	204	elevador para cuerpos extraños Buck	412	espátula abdominal Kümme	143/4, 144
Douglas-Bozemann pinza porta esponja	138	elevador para cuerpos extraños Quire	412	espátula abdominal Ribbon	143/1
Down-Mini-Townsend pinza para biopsia	591	elevador para duramadre	332, 333	espátula cerebral Cushing	336, 369
Down-Tischler pinza para biopsia	591	elevador para duramadre Davis	332	espátula cerebral Davis	337
Doyen especulo vaginal	574	elevador para duramadre Frazier	333	espátula cerebral Heifetz	369
Doyen estilete acanalado	199	elevador para duramadre Hoen	333	espátula cerebral Olivecrona	336
Doyen periostotomo	278	elevador para duramadre Horsley	333	espátula Locke	612/1
Doyen pinza de campo	133	elevador para duramadre Milligan	332	espátula para ciclodialis Bangerter	379
Doyen pinza intestinal	540	elevador para duramadre Olivecrona	332	espátula para ciclodialis Castroviejo	379
Doyen pinza para polipos uterinos	585	elevador para duramadre Penfield	333	espátula para ciclodialis Elschnig	379
Doyen separador	163	elevador para duramadre Sachs	332	espátula para ciclodialis Hirschman	379
Doyen separador abdominal	189/1	elevador para duramadre Toennis	332	espátula para ciclodialis Wheeler	379
Doyen tijera ginecologica	63	elevador para duramadre Woodson	333	espátula para enucleacion Wells	378
Doyen tirabuzon para fibroma	594	elevador para el tabique nasal Ballenger	439	espátula para iris Wecker	378
Doyen-Baby pinza intestinal	540	elevador para el tabique nasal Ballenger-Hajek	439	espátula para la intima Robb	530
Doyen-Jansen (Molt) abre-boca	454	elevador para el tabique nasal Cottle	439	espátula pulmonar Allison	489/2
Doyen-Stille separador	167	elevador para el tabique nasal Cottle Joseph	439	espátula vesical Kocher	552
Dubois tijera ginecologica	63	elevador para el tabique nasal Freer	437	espátula vesical Legueu	552
Duehrsen pinza de diseccion	84	elevador para el tabique nasal Hajek-Ballenger	439	espátulas abdominales	143-144
Duplay pinza porta-esponja	134	elevador para el tabique nasal Halle	437	espátulas para la intima	530-530/1
Duplay pinza uterina	582	elevador para el tabique nasal Howarth	438	especulo auricular	399-402
Duplex stetoscopio	23	elevador para el tabique nasal Joseph	437	especulo auricular Boucheron	399

especulo auricular Bruenings.....	401	estuche de diagnostico Ri-Mini	17	forceps obstetrico Elliot	603
especulo auricular Gruber	399	estuche de diagnostico Uni I	13	forceps obstetrico Kielland	602
especulo auricular Hartmann	399	estuche de diagnostico Uni II	14	forceps obstetrico Kielland-Luikart	603
especulo auricular Holmgren-Richnau.....	400	estuche de diagnostico Uni III.....	15	forceps obstetrico Luikart	603
especulo auricular Politzer	399	estuche para autopsia	269	forceps obstetrico Luikart-Kielland	603
especulo auricular Richnau-Holmgren.....	400	estuche para esterilizar agujas.....	615	forceps obstetrico Luikart-McLean-Tucker.....	603/1
especulo auricular Siegle	402	estuche para sutura Standard.....	226	forceps obstetrico Luikart-Simpson.....	603
especulo auricular Toynbee	399	Eves cierranudos	468	forceps obstetrico McLean	603/1
especulo endocervical Kogan	577	Exacta-Spezial esfigmomanómetro	8	forceps obstetrico McLean-Tucker.....	603/1
especulo Friedmann.....	477, 577	Excenter Hadeo tijera para vendaje	69/2	forceps obstetrico McLean-Tucker-Luikart	603/1
especulo nasal	421-423	explorador para calculos biliares Desjardins	531	forceps obstetrico Naeggele	603
especulo nasal Cottle	423	explorador para calculos biliares Moynihan	531	forceps obstetrico Piper	604
especulo nasal Halle-Hartmann	421	extractor Künstscher	322	forceps obstetrico Simpson	602
especulo nasal Halle-Tieck	423	extractor/impactor para clavos	321-322/1	forceps obstetrico Simpson-Braun.....	602
especulo nasal Hartmann	422			forceps obstetrico Simpson-Luikart.....	603
especulo nasal Hartmann-Halle	421	F		forceps obstetrico Tamier	604
especulo nasal Killian	423	face lift tijera Freeman	73	forceps obstetrico Tucker-Luikart-McLean	603/1
especulo nasal Mod. Vienna	421	face lift tijera Gorney	73	forceps obstetrico Tucker-McLean	603/1
especulo nasal Hadeo	423	face lift tijera Joseph Peck.....	73	forceps obstetrico Wrigley	602
especulo nasal Thudichum	421	face lift tijera kaye	73	forceps obstetricos Luikart-McLean	603/1
especulo nasal Tieck-Halle	423	face lift tijera Peck Joseph.....	73	forceps obstetricos McLean-Luikart	603/1
especulo nasal Vienna Mod.	421	face lift tijera Rees	73	forceps obstetricos Thiery	603
especulo nasal Voltolini	421	Fansler protoscopio.....	564	Foregger juego de laringoscopia	31
especulo rectal.....	559-561	Fansler-Ives anoscopio	562	Foregger laringoscopia	29
especulo rectal Alan-Parks	561	Farabeuf periostotomo	274	Fox cureta para lupus	608
especulo rectal Barr	559	Farabeuf pinza para hueso.....	243	Fox-Goldmann tijera para encias.....	67
especulo rectal Bergmann-Schulze	560	Farabeuf separador	139	Fraenkel pinza para laringe	471
especulo rectal Bodenhammer	559	Farabeuf-rectal Bodenhammer	274	Fraenkel punta de laringe	472
especulo rectal Czerny.....	559	Farabeuf-Lambotte pinza para hueso.....	243	Francis aguja para cuerpos extraños.....	374
especulo rectal Ferguson-Hill.....	560	Farrell porta-algodon	203	Frazier elevador para duramadre	333
especulo rectal Hill-Ferguson	560	Faulkner cureta.....	449	Frazier gancho	148/2
especulo rectal Mathieu	560	Faure pinza para biopsia.....	588	Frazier separador abdominal	181
especulo rectal Parks-Alan	561	Faure pinza para peritoneo	123	Frazier/Ferguson tubo de aspiracion	337
especulo rectal Pratt	559	Favaloro tijera vascular	61	Freeman separador	198
especulo rectal Sawyer.....	560	Favaloro-Morse separador costal	484	Freeman tijera face lift	73
especulo rectal Schulze-Bergmann	560	Fehland pinza intestinal	542	Freer cincel nasal	442/1
especulo rectal Sims	559	Feilchenfeld pinza para espinas.....	91	Freer cincel para el tabique nasal	439
especulo vaginal	569-577	Feldheim pinza para huesos	249	Freer cuchillo para tabique nasal	434
especulo vaginal Auvard	576	Ferguson-Hill especulo rectal.....	560	Freer elevador para el tabique nasal	437
especulo vaginal Breisky	577	Ferguson cuchara para calculos biliares.....	533	Freer gancho para la piel	448
especulo vaginal Collin	570	Ferguson pinza hemostatica	109	Frenzel anteojos para nistagmo	20
especulo vaginal Cosco	570, 571	Ferguson pinza para hueso	243	Frenzel baja-lengua	451
especulo vaginal Delee	574	Ferguson tijera para intestino	66	Frey-Sauerbruch costotomo	481
especulo vaginal Doyen	574	Ferguson tubo de aspiracion	337	Friedmann especulo	477, 577
especulo vaginal Grave	570	Ferguson/Frazier tubo de aspiracion	337	Friedmann micro pinza gubia	234
especulo vaginal Jackson	573	Ferriera separador para cirugia plastica	197	Friedmann mini pinza gubia	234
especulo vaginal Joll	477, 577	Ferris-Smith pinza cortante para laminectomia.....	343	Friedmann pinza gubia	234
especulo vaginal Kallmorgen	573	Ferris-Smith pinza de diseccion.....	85	Friedmann separador	477, 577
especulo vaginal Kristeller.....	572	Ferris-Smith-Kerrison pinza sacabocado		Fritsch separador	163
especulo vaginal Landau	577	para discos intervertebral	344, 344/2	Frykholm pinza gubia	240
especulo vaginal More-Vu	569	Finochietto pinza bronquial	490	Fuchs pinza capsular	391
especulo vaginal O'Connor-O'Sullivan	576	Finochietto porta aguja	211	Fuchsig pinza hemostatica	113
especulo vaginal O'Sullivan-O'Connor	576	Finochietto separador costal	482, 484		
especulo vaginal Pederson	570	Finochietto-Burford separador costal	483	G	
especulo vaginal Scherbak	575	Finochietto-Rienhoff separador costal.....	486	Gallaher lima para seno	446
especulo vaginal Semm	571	Finsen separador.....	168	gancho Frazier	148/2
especulo vaginal Sims	573	Fisch disector	420	gancho Graefe	148/2
especulo vaginal Trelat	571	Fisch gancho para duramadre	335	gancho Guthrie	148/2
especulo vaginal Vu-More.....	569	Fischer pinza para iris	384	gancho Joseph	149
espejo laringeo	423, 473	Fish sonda	199	gancho Kleinert-Kutz	149
espejo laringeo Michel	423	Fisher bisturi para amígdalas.....	466	gancho Kutz-Kleinert	149
estetoscopio Anestophon	23	Foerster pinza para iris.....	383	gancho Lahey	149
estetoscopio Duplex.....	23	Foerster porta esponjas	136	gancho nasal Fomon	447/1
estetoscopio Pinard	23	Fomon cincel nasal	441	gancho abotonado Lucae	409
estilite abotonado.....	199	Fomon gancho nasal	447/1	gancho abotonado Wagener.....	409
estilite acanalado abotonado	199	Fomon lima nasal	444, 445	gancho auricular Day	409
estilite acanalado Doyen	199	Fomon periostotomo	277	gancho Barbara	419
estilite hoja mirte	199	Fomon tijera nasal.....	58	gancho Clayman	376
estribo para extension Böher	312	Fomon tijera para rinoplastia	65/1	gancho cutaneo Kilner	608
estribo para extension Kirschner	312	forceps obstetrico Barton	603/2	gancho de decapitacion Braun	607
estribo para extension Kirschner U.S.	312	forceps obstetrico Boerma	604	gancho de menton Obwegeser	461/1
estribo para extension U.S. Kirschner	312	forceps obstetrico Braun-Simpson	602	gancho extractor	322
estuche de diagnostico ECO "T" y ECO "C"	16	forceps obstetrico DeLee	602	gancho Gass	376

gancho Kirschner	313	Good tijera para amigdalas	59	H	
gancho Klapp	150	Goodell dilatador uterino	581	Haberer espátula abdominal	143/3
gancho Knapp	375	Gorney disector	277	Haberisser-Mayo pinza para torcer hilo	319
gancho McGee	419	Gorney tijera face lift	73	Haglund-Stille separador para yesos	232
gancho muscular	267, 375	Gosset separador abdominal	181	Haight separador costal	487
gancho muscular Green	375	Gourdet cureta uterina	599	Hajek cincel nasal	442/1
gancho obstétrico Smellie	605	Gradle pinza depiladora	395	Hajek martillo	273
gancho para cristalino Stevens	375	Gradle tijera para oftalmología	57	Hajek-Ballenger elevador para el tabique nasal	439
gancho para duramadre	335	Graefe blefarostato	370	Hajek-Kofler pinza cortante	429
gancho para duramadre Adson	329	Graefe cucharilla para cataratas	377	Hajek-Kofler pinza sacabocado	431
gancho para duramadre Fisch	335	Graefe cuchillo para cataratas	371	Halle cucharilla cortante	253
gancho para estrabismo Graefe	375	Graefe cuchillo para discision	372	Halle elevador para el tabique nasal	437
gancho para estrabismo Jameson	375	Graefe ganchito	148/2	Halle-Hartmann especulo nasal	421
gancho para extraccion Arruga	375	Graefe gancho para estrabismo	375	Halle-Ritter dilatador para el seno	433
gancho para fistulas Emmet	594	Graefe pinza de diseccion	83	Halle-Tieck especulo nasal	423
gancho para galea Yasargil	330	Graefe pinza para fijacion	389	Halsey porta aguja	208
gancho para iris O'Conner	375	Graefe pinza para iris	382	Halsted-Mosquito pinza hemostatica	105
gancho para iris Wiener	375	Graefe quistotomo	375	Hank dilatador uterino	580
gancho para la piel Cottle	448	Graefe tijera para cirugía	56	Hargis separador para el borde anterior	463
gancho para la piel Cottle-Neivert	448	Graham gancho para nervio	329	Hargis separador para el cuerpo mandibular	463/6
gancho para la piel Freer	448	Graig pinza para tabique nasal	426	Harken pinza auricular	503
gancho para la piel Gillies	448	grapa para cuero cabelludo Raney	327	Harms sonda	381
gancho para la piel Neivert-Cottle	448	grapas	326	Harrington pinza bronquial	490
gancho para las alas de la nariz Lange	448	grapas de plata	326	Harrington separador	147
gancho para nervio Crile	328	Grave especulo vaginal	570	Harrington-Pemberton separador	147
gancho para nervio Cushing	328	Gray pinza hemostatica	121	Hartmann baja-lengua	452
gancho para nervio Dandy	328	Green disecador corneal	374	Hartmann cateter auricular	408
gancho para nervio Graham	329	Green gancho muscular	375	Hartmann diapason	403
gancho para nervio Krayenbühl	336	Green pinza para fijacion	390	Hartmann especulo auricular	399
gancho para nervio Sachs	329	Green separador	160	Hartmann especulo nasal	422
gancho para nervio Smithwick	329	Green-Armytage pinza para uterus	605	Hartmann pinza auricular	411
gancho para sacar el inserto I.U.D.	593	Green-Langenbeck separador	153	Hartmann pinza hemostatica	104
gancho para traqueotomia Bose	477	Green-Senn separador	153	Hartmann pinza nasal	424, 427
gancho para traqueotomia Iterson	477	Gregoire pinza intestinal	538	Hartmann pinza para polipos	412
gancho para traqueotomia Jackson	476	Gregory pinza atraumatica	517	Hartmann-Collin separador	141
gancho para traqueotomia News	477	Greven pinza auricular micro	414	Hartmann-Halle especulo nasal	421
gancho Hadeo	150	Grip alicate	316	Hartmann-Hoffmann pinza para polipos	412
gancho Rollet	375	Grip Kelly separador	142	Hartmann-Wullstein pinza para polipos	412
gancho Rosen	419	Grip Richardson separador	142	Hasson separador	143
gancho Shambaugh	419	Grip-Deaver separador	146	Haugh pinza auricular micro	414
gancho Sinsky	376	Gross cuchara y gancho	409	Haverfield-Scoville separador para laminectomia	196
gancho y cuchara Gross	409	Gross-Maier pinza porta-esponja	134	Hayes pinza para anastomosis	545
ganchos	419	Gruber especulo auricular	399	Heaney pinza para histerectomia	126
garrote de madera Maunder	459	Gruenwald-Jansen pinza nasal	424	Heaney porta aguja	210
Gass gancho	376	Gruenwald-Love pinza cortante para laminectomia	340	Heaney separador	164
Gauss pinza para pericraneio	605	gubia	259-265	Heany cureta para biopsia	587
Gaylor-Thomas pinza para biopsia	588	gubia Alexander	259	Heany-Ballentine pinza para histerectomia	127
Geissendoerfer-Overholt pinza hemostatica	114	gubia Brünings-Lucas	260	Heath martillo	273
Gelpi separador perineal	189/1, 189/2	gubia Cobb	262	Heath tijera para ligadura	86
Gemini pinza hemostatica	115	gubia Hibbs	265	Heath-Richter pinza para quitar agrafes	224
Gerald pinza de diseccion	86, 87	gubia Lexer	263	Hebra cucharilla para chalazion	377
Gerster barra de traccion	250	gubia Lexer Mini	263	Hegar dilatador uterino	578, 579
Gerzog martillo	270	gubia Lucas-Brünings	260	Hegar-Corwin pinza para torcer hilo	319
Gibbon-Bailey aproximador para costillas	489/1	gubia Mini Lexer	263	Hegar-Mayo porta aguja	209
Gieritz-Stille costotomo	481	gubia para cuerpos extraños Ellis	374	Hegar-Olsen porta aguja	212
Gigli mango para sierra hilo	332	gubia para cuerpos extraños Walton	374	Hegenbarth pinza para aplicar agrafes	224
Gill cuchillo corneal	373	gubia Partsch	259	Heifetz espátula cerebral	369
Gill pinza para iris	384	gubia Petersen-Smith	261	Heiming pinza para calculos renales	536
Gill-Arruga pinza capsular	390	gubia Smith-Petersen	261	Heiss pinza hemostatica	112
Gill-Hess pinza para iris	384	gubia Stille	260	Heister abre-boca	454
Gillies gancho para la piel	448	gubia Zielke	264	hemostatico	258, 259
Gillies pinza de diseccion	86	guia-conductora DeMartel	330	hemostatico Caspar	258
Gillies porta aguja	212	guia-conductora para clavos medulares	321	Henke elevador para amigdalas	465
Gil-Vernet separador	152	Guilen legra de succion	433/1	Henley separador	170
Glover clamp atrauma bulldog	100, 103	Gunar-Hey-Bülow pinza cierra-tubo	130	Hennig separador para yesos	232
Glover pinza para uso multiple	515	Guthrie ganchito	148/2	Hepp-Scheidel micro tijera	78
Gluck costotomo	480	Guyon bujia dilatadora	554	Hercules alicates para alambres	320/1-320/3
Goelet separador	141	Guyon mandril para cateter	554	Herrick pinza para pediculo	123
Goldman-Fox tijera para encias	67	Guyon pinza hemostatica	122	Hess pinza capsular	391
Gomel micro tijera	80	Guyon-Mayo pinza hemostatica	122	Hess pinza para iris	384
Gomel pinza para microcirugía	96	Guyton-Lundsgaard esclerotomo	373	Hess separador para la raiz de nervios	329/1
goniometro Moeltgen	25			Hess-Gill pinza para iris	384
goniometro para dedos	25			Hey-Bülow-Gunar pinza cierra-tubo	130

Heymann pinza nasal.....	425	instrumento para vendaje enyesado Hadeo.....	232	juego para varices Nabatoff.....	201
Heymann tijera nasal.....	58	instrumentos para manicura.....	612, 612/1	Juers pinza auricular micro.....	414
Heymann-Knight pinza nasal.....	425	instrumentos para medir.....	594	Jurasz pinza para polipos laringeos.....	471
Heywood-Smith pinza hemorroidal.....	567	instrumentos para traqueotomia.....	475		
Hibbs cincel.....	265	lowa pinza uterina.....	584	K	
Hibbs gubia.....	265	Iris tijera para cirugia.....	54/2	Kabierske lanzapolo.....	405
Hibbs osteotomo.....	265	Iris tijera supercut.....	72	Kader espátula abdominal.....	143/3
Hibbs separador.....	164	Israel separador.....	162	Kallmorgen especulo vaginal.....	573
Hill-Ferguson especulo rectal.....	560	Irterson gancho para traqueotomia.....	477	Kalt pinza capsular.....	391
hilos para huesos.....	314	Ives-Fansler anoscopio.....	562	Kalt porta aguja.....	214
Hirschman espátula para ciclodialis.....	379	Iwanson calibrador decimal.....	624	Kalt-Arruga porta aguja.....	214
Hirschmann anoscopio.....	562			Kane clamp umbilical.....	605
histerometro Collin.....	586	J		Kantrowitz pinza hemostatica.....	119/1
histerometro Martin.....	586	Jackson especulo vaginal.....	573	Kaye tijera face lift.....	73
histerometro Sims.....	586	Jackson gancho para traqueotomia.....	476	Kay-Lambert pinza para anastomosis.....	505
histerometro Valleix.....	586	Jackson laringoscopia.....	37	Kazanjian-Cottle pinza cortante para huesos.....	241
Hoen elevador para duramadre.....	333	Jackson pinza de agarre para tendones.....	292	Kelly Grip separador.....	142
Hoessel porta aguja.....	213	Jackson pinza para tapones.....	471	Kelly pinza hemostatica.....	106
Hofer separador para pilar.....	465	Jackson portador de luz.....	37	Kelly pinza para polipos uterinos.....	585
Hoffmann cierra-tubos.....	624	Jackson separador traqueal.....	476	Kelly protoscopia.....	562, 563
Hoffmann-Hartmann pinza para polipos.....	412	Jackson-Burrows separador.....	189/2	Kelly separador.....	142, 164
Hoglund-Lowman pinza para huesos.....	249	Jackson-Chevalier canula para traqueotomia.....	479	Kelly tijera vascular.....	61
Hohmann elevador.....	284, 285	Jackson-Chevalier pinza para bronco-esofagoscopia.....	473	Kelly-Rankin pinza hemostatica.....	106
Hohmann mini elevador.....	286	Jacobs pinza uterina.....	583	Kern pinza para hueso.....	244
Hohmann-Lange elevador.....	286	Jacobsen porta aguja.....	215	Kerrison pinza cortante.....	428
hoja de repuesto para dermatomo.....	49, 50	Jacobson cucharilla cortante.....	257	Kerrison-Ferris-Smith pinza sacabocado	
hojas de afeitar.....	45	Jacobson sonda abotonada.....	335	para discos intervertebral.....	344, 344/2
hojas de bisturi, esteril.....	42	Jaeger cuchillo de discision.....	372	Kevorkian cureta para biopsia.....	587
hojas de cincel intercambiables.....	266	Jaeger placa para parpado.....	371	Kevorkian pinza para biopsia.....	589, 591
hojas de osteotomo intercambiables.....	266	Jameson gancho para estrabismo.....	375	Kevorkian-Pacific pinza para biopsia.....	592
Hoke osteotomo.....	265	Jansen pinza para estrabismo.....	385	Kevorkian-Tischler pinza para biopsia.....	592
Holinger laringoscopia.....	37	Jansen cucharilla cortante.....	257	Key elevador.....	282
Holinger portador de luz.....	37	Jansen pinza gubia.....	237	Keys trepano.....	608
Holmgren-Richnau especulo auricular.....	400	Jansen pinza nasal.....	424	Kielland forceps obstetrico.....	602
Holsher separador para la raiz de nervios.....	329/1	Jansen separador.....	168	Kielland-Luikart forceps obstetrico.....	603
Holth pinza para capsuloridectomia.....	380	Jansen-Doyen (Molt) abre-boca.....	454	Killian (Eicken) canula irrigacion.....	433
Holzbach pinza para histerectomia.....	126	Jansen-Gruenwald pinza nasal.....	424	Killian canula.....	433/1
Holzheimer separador.....	168	Jansen-Middleton pinza para el tabique nasal.....	430	Killian cincel nasal.....	442/1
Hopkins cuchillo para vendaje enyesado.....	233	Jansen-Zaufal elevador auricular.....	409	Killian elevador para el tabique nasal.....	438, 439
Hopkins-Johns pinza hemostatica.....	120	Jansen-Zaufal pinza gubia.....	238	Killian especulo nasal.....	423
Hopkins-Johns serra-fina.....	104	Jarcho pinza uterina.....	583	Killian tijera para septo.....	471
Horne-Jobson porta-algodon.....	203	Javid pinza para shunt carotido.....	511	Killian-Claus cincel nasal.....	442/1
horquilla fijadora Burch.....	373	Jennings abre-boca.....	454	Kilner gancho cutaneo.....	608
Horsley elevador para duramadre.....	333	Jensen canula capsular.....	394	Kilner porta aguja.....	212
Horsley-Stille pinza cortante para huesos.....	242	jeringa.....	406, 407, 470	Kilner retractor nasal.....	447/1
Hösel separador.....	167	jeringa auricular Reiner.....	406	Kilner tijera para cirugia.....	54/1
Hospital-Providence pinza hemostatica.....	106	jeringa para amigdalas.....	470	Kilner/Ragnell tijera supercut.....	72
House cureta.....	420	Jobson-Horne porta-algodon.....	203	Kilner-Doughty abre-boca.....	456
House sonda para medir.....	420	Johns-Hopkins pinza hemostatica.....	120	Kirby-Arthur pinza para fijacion.....	385
House tubo de aspiracion.....	337/2	Johns-Hopkins serra-fina.....	104	Kirk martillo.....	270
Howarth elevador para el tabique nasal.....	438	Joll especulo vaginal.....	477, 577	Kirschner alambre.....	306, 307
Huber mango universal.....	472	Joll separador.....	477, 577	Kirschner estribo para extension.....	312
Hudson perforador de mano.....	299	Jones pinza de campo.....	132	Kirschner gancho.....	313
Hulka pinza uterina.....	583	Jones-Clip pinza de campo.....	132	Kirschner perforador de mano.....	299
Humby dermatomo.....	50	Jones-Leland pinza para vasos perifericos.....	495	Kirschner separador abdominal.....	185, 187, 187/1
Hunter pinza para espinas.....	91	Jonson porta aguja.....	211	Kirschner sonda conductora.....	221
Hurd elevador para amigdales.....	465	Jorgensen tijera de disecion.....	53	Kirschner soporte de esterilizacion para alambres.....	305
I		Joseph (Lewis) lima nasal.....	443	Kirschner U.S. estribo para extension.....	312
I.U.D. gancho para sacar el inserto.....	593	Joseph bisturi nasal.....	434, 435	Klapp gancho.....	150
iman ocular Hadeo.....	395	Joseph Cottle elevador para el tabique nasal.....	439	Kleinert-Kutz gancho.....	149
impactor final Kuentscher.....	321	Joseph elevador para el tabique nasal.....	437	Kleinert-Kutz pinza de agarre para tendones.....	294
impactor/extractor para clavos.....	321-322/1	Joseph gancho.....	149	Kleinert-Kutz pinza gubia.....	237
Inge separador para cuerpo vertebral.....	339	Joseph lima para hueso.....	443	Kleinsasser anillo.....	36
Ingrown instrumento para uña.....	612/1	Joseph Peck tijera face lift.....	73	Kleinsasser articulacion.....	36
InstruCare aceite para instrumentos.....	635	Joseph periostotomo.....	277	Kleinsasser canula de inyeccion.....	36
instrumento para circuncision.....	556	Joseph sierra nasal.....	446	Kleinsasser canula de succion.....	36
instrumento para circuncision Mogen.....	556	Joseph tijera para cirugia.....	54/1	Kleinsasser laringoscopia operativo.....	35
instrumento para cuerpo extraños Dix.....	380	Judd-Allis pinza intestinal.....	538	Kleinsasser portador de luz fria.....	36
instrumento para cuerpo extraños LaForce.....	374	Judd-Masson separador vesical.....	552	Kleinsasser soporte pectoral.....	36
instrumento para el fragmento de la uña.....	612/1	juego de laringoscopia Foregger.....	31	Kleinschmidt pinza para apendice.....	544
instrumento para uña Ingrown.....	612/1	juego de laringoscopia McIntosh.....	31	Klinikum Berlin pinza cierra-tubo.....	129
instrumento para varices Varady.....	202	juego de manicura para enfermeras.....	609	Klinkenbergh-Loth tijera vasija.....	65/2
		juego de recambio para alicate Hercules.....	320/1-320/3	Knapp cucharilla para cataratas.....	378

Knapp cuchillo para iris.....	372	Lane pinza de diseccion	84	lima para uñas.....	610
Knapp gancho.....	375	Lane pinza estomacal	547	Lister (Sinus) pinza porta esponja.....	137
Knapp tijera para cirugía.....	55	Lane pinza para hueso.....	244	Lister tijera para vendaje.....	69/1
Knapp-Luer pinza para tracoma.....	393	Lane pinza para sostener placas.....	325	Lister tijera supercut.....	72
Knight pinza nasal.....	425	Lane pinza para sostener tornillos.....	325	Lister-Burch blefarostato.....	370
Knight-Heymann pinza nasal.....	425	Lane Trethowan elevador.....	290	Liston cuchillo para amputacion.....	44
Knowles tijera para vendaje.....	70	Lane-Murphy elevador.....	283	Liston pinza cortante para huesos.....	241
Kocher espátula vesical.....	552	Lang diseccador para el saco lacrimal.....	378	Liston-Ruskin pinza cortante para huesos.....	241
Kocher pinza hemostatica.....	108	Lange gancho para las alas de la nariz.....	448	Liston-Stille pinza cortante para huesos.....	242
Kocher pinza intestinal.....	540	Lange punta de pinza.....	472	Littauer pinza auricular.....	411
Kocher separador.....	155, 159, 160, 163	Lange-Hohmann elevador.....	286	Littauer pinza depilatoria.....	395
Kocher sonda para bocio.....	479	Langenbeck asa.....	409	Littauer pinza para polipos.....	425
Kocher-Langenbeck separador.....	159	Langenbeck cuchillo para amputacion.....	44	Littauer tijera para ligadura.....	66
Koenig sonda conductora.....	221/1	Langenbeck cuchillo para reseccion.....	47	Little separador.....	157
Koenig-Roser abre-boca.....	454	Langenbeck periototomo.....	275	Little tijera para cirugía.....	55
Koerte separador.....	162	Langenbeck pinza para hueso.....	243	Littlewood pinza intestinal.....	538
Koerte-Luer cuchara para calculos biliares.....	533	Langenbeck porta aguja.....	213	llave de tuerca.....	313
Kofler-Hajek pinza cortante.....	429	Langenbeck separador.....	158, 159	Locke espátula.....	612/1
Kofler-Hajek pinza sacabocado.....	431	Langenbeck sierra para amputacion.....	296	Lockhart-Mummary sonda para fistula.....	200
Kogan especulo endocervical.....	577	Langenbeck-Green separador.....	153	Locklin tijera para encias.....	69
König elevador.....	284	Langenbeck-Kocher separador.....	159	Lockwood-Allis pinza intestinal.....	538
König periototomo.....	276	Langenbeck-Parker / Us Army separador.....	141	Loktite Collin separador abdominal.....	191
König separador.....	153	lanzapolvo Kabierske.....	405	London-College pinza dental.....	93
Koos micro cuchillo.....	335	laringoscopia Foregger.....	29	Lopez-Reinke elevador para amigdales.....	465
Körte separador.....	143/3	laringoscopia Holinger.....	37	Lorenz tijera para vendaje.....	70
Krause cierra-nudo auricular.....	411	laringoscopia Jackson.....	37	Lorna pinza para campo.....	133
Krause polipotomo.....	433/2	laringoscopia McIntosh.....	29	Loth-Klinkenbergh tijera vasija.....	65/2
Krause punta de pinza.....	472	laringoscopia Miller.....	30	Loute tensor de cierra-hilo.....	315
Krause-Voss polipotomo.....	433/2	laringoscopia operativo Kleinsasser.....	35	Love separador para la raiz de nervios.....	329/2, 330
Krayenbühl gancho para nervios.....	336	Larsen pinza para tendones.....	292	Love separador para uvula.....	465
Kristeller especulo vaginal.....	572	Lawrence pinza hemostatica.....	119	Love-Gruenwald pinza cortante para laminectomia.....	340
Kroenig baja-lengua.....	451	Lebsche cincel de esternon.....	267	Lovelace pinza hemostatica.....	109
Kronecker aguja para ligadura.....	219	Lees pinza bronquial.....	504	Lovelace pinza para coger el pulmon.....	490
Kuentscher impactor final.....	321	legra de succion Guilen.....	433/1	Lower pinza hemostatica.....	120
Kuglen manipulador.....	376	Legueu espátula vesical.....	552	Lowman pinza para huesos.....	249
Kümmel espátula abdominal.....	143/4, 144	Legueu separador vesical.....	553	Lowman-Hoglund pinza para huesos.....	249
Kümmel separador abdominal.....	143/4	Leksell (Stille) pinza gubia.....	240	Lowman-Lambert pinza para huesos.....	249
Küntscher extractor.....	322	Leland-Jones pinza para vasos perifericos.....	495	Lubet-Barbon pinza nasal.....	424
Küntscher perforador para femur.....	321	Lempert cuchara/corta.....	256	Luc pinza nasal.....	426
Küntscher perforador para la cavidad medular.....	321	Lempert elevador.....	420	Lucae aguja para paracentesis.....	408
Kutz-Kleinert ganchito.....	149	Lempert pinza gubia.....	237	Lucae diapason.....	404
Kutz-Kleinert pinza de agarre para tendones.....	294	Lerche pinza de diseccion.....	83	Lucae gancho abotonado.....	409
Kutz-Kleinert pinza gubia.....	237	Lerliche pinza hemostatica.....	111	Lucae martillo.....	271
L		Lerliche separador intestinal.....	143/4	Lucae pinza auricular.....	410
L&M separador intra oral.....	463/4	Lester pinza para fijacion.....	389	Luer canula para traqueotomia.....	479
Laborde dilatador traqueal.....	476	Levinson aguja para cuerpos extraños.....	374	Luer pinza gubia.....	236
Lacrimal canula.....	394	Lewin pinza para hueso.....	246	Luer separador.....	140
LaForce adenotomo.....	450	Lewis (Joseph) lima nasal.....	443	Luer-Knapp pinza para tracoma.....	393
LaForce instrumento para cuerpos extraños.....	374	Lexer Baby tijera de diseccion.....	53	Luer-Koerte cuchara para calculos biliares.....	533
LaGrange tijera para encias.....	69	Lexer gubia.....	263	Luer-Stille pinza gubia.....	239
LaGrange tijera supercut.....	72	Lexer Mini gubia.....	263	Luikart forceps obstetrico.....	603
Lahey ganchito.....	149	Lexer Mini osteotomo.....	263	Luikart-Bill tractor.....	604
Lahey pinza hemostatica.....	119/2, 120	Lexer osteotomo.....	263	Luikart-Kielland forceps obstetrico.....	603
Lahey pinza para agarrar el bocio.....	479	Lexer tijera de diseccion.....	53	Luikart-McLean-Lexer forceps obstetrico.....	603/1
Lahey separador.....	157	Leyla separador de sistema.....	368-368/3	Lundsgaard esclerotomo.....	373
Lambert pinza para chalazion.....	393	lezna Obwegeser.....	463, 463/3	Lundsgaard-Guyton esclerotomo.....	373
Lambert-Kay pinza para anastomosis.....	505	Lichtenberg porta aguja.....	213	Luniatschek tamponeador.....	465
Lambert-Lowman pinza para huesos.....	249	Lichtwitz trocar para seno maxilar.....	204	M	
Lambotte osteotomo.....	261	Liebermann blearostato.....	371	Magill pinza para introducir cateter.....	28
Lambotte periototomo.....	274	ligador para hemorroides.....	568	Maier-Gross pinza porta-esponja.....	134
Lambotte pinza para hueso.....	244	ligador para hemorroides Rudd.....	568	Maingot pinza para histerectomia.....	123/1, 123/2
Lambotte-Farabeuf pinza para hueso.....	243	lima nasal Aufricht.....	443	malla de alambre.....	311
lampara frontal Clar.....	22	lima nasal Cottle (Maltz).....	444	Maltz (Cottle) lima nasal.....	444
lampara halogena.....	29	lima nasal Fomon.....	444, 445	Maltz lima nasal.....	443, 444
Lancaster blefarostato.....	371	lima nasal Joseph (Lewis).....	443	mamaria separador.....	486/1
Landau especulo vaginal.....	577	lima nasal Joseph (Joseph).....	443	mandril.....	300
Landau-Segond pinza para histerectomia.....	125	lima nasal Maltz.....	443, 444	mandril para cateter Guyon.....	554
Landolt pinza para tumores.....	341/2	lima nasal Maltz (Cottle).....	444	mango bisturi Mini.....	41
Lane destornillador.....	323, 324	lima para hueso Joseph.....	443	mango bisturíes.....	38-41
Lane elevador.....	290	lima para huesos.....	294, 443-446, 612/1	mango con iluminacion para protoscopia Morgan.....	565
Lane palanca para doblar placas.....	325	lima para huesos Putti.....	294	mango de acople rapido.....	301
Lane pinza de campo.....	133	lima para seno Gallaher.....	446	mango de aspiracion Wullstein.....	338

mango de bisturi Collin.....	40	Mayo-Noble tijera de diseccion.....	52/1	Millin pinza para ligadura.....	551
mango de pila para laringoscopia.....	32-34	Mayo-Robson pinza intestinal.....	541	Millin pinza para lobo anterior.....	551
mango para cincel/gubia.....	266	Mayo-Stille tijera de diseccion.....	52/1	Millin separador cuello vejiga.....	553
mango para espejo laringeo.....	473	Mayo-Stille tijera supercut.....	71	Millin separador vesical.....	552
mango para sierra hilo Gigli.....	332	McCullough pinza para estrabismo.....	385	Mini Friedmann pinza gubia.....	234
mango universal Huber.....	472	McDonald elevador.....	283	Mini Hohmann elevador.....	286
manguito de cierre Stone-Watt.....	545	McGee gancho.....	419	Mini mango de bisturi.....	41
manguito de cierre Watt-Stone.....	545	McGee pinza auricular micro.....	414	Mini Roux separador.....	140
manipulador Kuglen.....	376	McGivney ligador para hemorroides.....	568	Mini-Lambotte osteotomo.....	262
manometro.....	295	McGivney pinza para hemorroides.....	568	Minimus II esfigmomanometro.....	11
manopla de plomo.....	250	McIndoe pinza cortante para huesos.....	241	Minimus III esfigmomanometro.....	12
marcador Amsler-Connin.....	380	McIndoe pinza de diseccion.....	85	Mini-Townsend-Down pinza para biopsia.....	591
marcador Connin-Amsler.....	380	McIndoe tijera para cartilago.....	65/1	Mini-Townsend-Up pinza para biopsia.....	591
Marquardt pinza gubia.....	239	McIntosh juego de laringoscopia.....	31	Minnesota-Cawood baja-lengua.....	451
Marschik pinza para amigdalas.....	468	McIntosh laringoscopia.....	29	Mixer Baby pinza hemostatica.....	119/1
Martel pinza hemostatica.....	110	McIntyre canula lacrimal.....	394	Mixer pinza hemostatica.....	116, 119/1-120
Martel Willet pinza hemostatica.....	110	McIvor abre-boca.....	457	Mixer pinza para calculos biliares.....	530/2, 531
martillo.....	24, 270-273	McKenty elevador para el tabique nasal.....	437, 438	Mixer-DeBakey pinza para ligaduras.....	499/2
martillo Bergmann.....	272	McKenzie pinza aplicadora.....	326	Mixer-O'Shaughnessy pinza hemostatica.....	119/2
martillo Collin.....	270	McLean forceps obstetrico.....	603/1	Mixer-Overholt pinza hemostatica.....	115
martillo Cottle.....	273	McLean-Luikart forceps obstetricos.....	603/1	Mod. Bonn pinza para sutura.....	386
martillo de percusion Babinsky.....	24	McLean-Tucker forceps obstetrico.....	603/1	Mod. Muenchen cureta para biopsia.....	587
martillo de percusion Berliner.....	24	McLean-Tucker-Luikart forceps obstetrico.....	603/1	Mod. Tübingen pinza para ligadura.....	392
martillo de percusion Buck.....	24	McPherson pinza para ligadura.....	392	Mod. Tübingen pinza para sutura.....	386
martillo de percusion Taylor.....	24	Mead martillo.....	271	Mod. USA tijera para cordon umbilical.....	64
martillo de percusion Troemner.....	24	Mead pinza gubia.....	235	Mod. Vienna especulo nasal.....	421
martillo Gerzog.....	270	Meeker pinza hemostatica.....	119	Moellgen goniometro.....	25
martillo Hajek.....	273	Mehdorn pinza para vasos.....	362	Mogen instrumento para circuncision.....	556
martillo Heath.....	273	Mellinger blefarostato.....	370	Mollison separador.....	171
martillo Kirk.....	270	Mellinger-Axenfeld blefarostato.....	370	Molt (Doyen-Jansen) abre-boca.....	454
martillo Lucas.....	271	Menghini aguja para biopsia.....	206	Molt periostotomo.....	276
martillo Mead.....	271	meniscotomo Neff.....	292	mondador de tendones Brand.....	294
martillo Ombredanne.....	273	meniscotomo Smillie.....	292	monopolares pinza.....	634
martillo Partsch.....	271	Mercedes separador toracico.....	489	Moor cuchara para calculos biliares.....	531
martillo Quising.....	271	Meriam pinza dental.....	93	Moore perforador de mano.....	298
martillo Williger.....	271	Metzenbaum porta aguja.....	211	Moore-Staude pinza uterina.....	582
Martin histerometro.....	586	Metzenbaum tijera de diseccion.....	53/1	Moorfield pinza para sutura.....	392
Martin pelvimetro.....	605	Metzenbaum tijera para cirugia.....	54	More-Vu especulo vaginal.....	569
Martin pinza para cartilago.....	246	Metzenbaum tijera supercut.....	71	Morgan proctoscopio.....	565
Martin separador.....	175/1	Meyer pinza para huesos.....	248	Morgan-Tischler pinza para biopsia.....	590, 591
Martin-Cartilago tijera.....	65/1	Meyer-Davis abre-boca.....	457	Moritz-Schmidt baja-lengua.....	452
Martini cucharilla cortante.....	257	Meyering separador.....	157, 177, 180	Morris separador.....	164
Masing elevador.....	437	Meyhoefer cucharilla para chalazion.....	377	Morris-DeBakey pinza para la aorta.....	506
Masing elevador para tabique nasal.....	437	Michel agrafe.....	224	Morse separador costal.....	484
Masing retractor nasal.....	447	Michel espejo laringeo.....	423	Morse-Favaloro separador costal.....	484
Masing-Neivert retractor nasal.....	447	Michel pinza para aplicar agrafes.....	224	Mosher-Wagener canula para traqueotomia.....	477
Masson porta aguja.....	210	Michel pinza para aplicar y quitar agrafes.....	224	Mosquito-DeBakey pinza hemostatica.....	509
Masson-Judd separador vesical.....	552	micro cuchillo Koos.....	335	Mosquito-Halsted pinza hemostatica.....	105
Mastin pinza muscular.....	479	Micro Friedmann pinza gubia.....	234	Moynihan explorador apra calculos biliares.....	531
Mathieu especulo rectal.....	560	micro pinza.....	86, 94	Moynihan pinza de campo.....	133
Mathieu pinza para cuerpos extraños.....	553/1	micro pinza auricular.....	413-415	Moynihan pinza hemostatica.....	120
Mathieu porta aguja.....	213	micro porta aguja Barraquer.....	216, 217	Mueller blearostato.....	371
Mathieu separador.....	141	micro porta aguja Barraquer-Troutman.....	216	Muenchen Mod. cureta para biopsia.....	587
Mathieu-Olsen porta aguja.....	212	micro porta aguja Castroviejo-Standard.....	216	Müller aproximador.....	364
Matson periostotomo.....	279	micro porta aguja Standard-Castroviejo.....	216	Müller clip para vasos.....	365
Matson-Alexander periostotomo.....	279	micro porta aguja Troutman-Barraquer.....	216	Müller-Verbrugge elevador.....	286/2
Maunder garrote de madera.....	459	micro tijera.....	76-78	Mummery-Lockhart sonda para fistula.....	200
Maxi Grasper pinza para biopsia.....	593	micro tijera Circumflex.....	76	Murdoch blefarostato.....	370
May oftalmoscopio Uni II.....	14	micro tijera Gomei.....	80	Murphy separador.....	156
Mayfield pinza gubia.....	238	micro tijera Hepp-Scheidel.....	80	Murphy-Lane elevador.....	283
Mayo baja-lengua.....	451	micro tijera Hadeo.....	77, 80	Murray-Crile porta aguja.....	209
Mayo clip para esterilizacion.....	227, 624	micro tijera Scheidel-Hepp.....	78	Museux pinza uterina.....	583
Mayo cuchara para calculos biliares.....	534	Micro-Castroviejo porta aguja.....	215	Myles pinza nasal.....	427
Mayo pinza de diseccion.....	89	Microvascular porta aguja.....	210		
Mayo sonda para calculos biliares.....	534	Middeldorf separador.....	160	N	
Mayo tijera de diseccion.....	52/1	Middleton-Jansen pinza para el tabique nasal.....	430	Nabatoff juego para varices.....	201
Mayo tijera supercut.....	71	Mikulicz pinza intestinal.....	543	Naegele forceps obstetrico.....	603
Mayo-Adams separador.....	171	Mikulicz pinza para peritoneo.....	123	Nager aguja para sutura del paladar.....	466
Mayo-Blake pinza para calculos biliares.....	530/2	Mikulicz separador.....	163	Nager separador para paladar.....	465
Mayo-Collins separador.....	141	Miller laringoscopia.....	30	Nasalis-Spina separador para el ramo.....	461
Mayo-Guyon pinza hemostatica.....	122	Miller-Senn separador.....	143	navaja.....	49
Mayo-Haberger pinza para torcer hilo.....	319	Milligan elevador para duramadre.....	332	Neff meniscotomo.....	292
Mayo-Hegar porta aguja.....	209	Millin pinza de agarre para capsula.....	550, 551	Negus pinza para coger amigdalas.....	467

Negus soporte de pecho.....	459	Overholt-Baby pinza hemostatica.....	114	periotostotomo Matson-Alexander.....	279
Neivert porta aguja.....	208	Overholt-Geissendoerfer pinza hemostatica.....	114	periotostotomo Molt.....	276
Neivert-Anderson cincel nasal.....	442	Overholt-Mixer pinza hemostatica.....	115	periotostotomo Obwegeser.....	462
Neivert-Cottle gancho para la piel.....	448			periotostotomo Quervain.....	275
Neivert-Masing retractor nasal.....	447	P		periotostotomo Sableau.....	275
Nelaton sonda.....	199	Pacific-Kevorkian pinza para biopsia.....	592	periotostotomo Sedillot.....	274, 275
Nelson (Standard) trocar abdominal.....	204	palanca para doblar placas Lane.....	325	periotostotomo Seldin.....	277
Nelson aguja para ligadura.....	219	Palmer-Pozzi pinza uterina.....	582	periotostotomo Semb.....	278
Nelson pinza de diseccion.....	89	Park bierarostato.....	371	periotostotomo Williger.....	276
Nelson trocar.....	205	Parker separador.....	139	Perkins separador.....	168
Neonatal pinza vascular.....	523	Parker-Langenbeck / Us Army separador.....	141	Perthes escariador.....	304
News gancho para traqueotomia.....	477	Partsch cincel.....	259	Pestalozza cureta para aborto.....	606
Nissen pinza hemostatica.....	113	Partsch gubia.....	259	Petersen-Smith cincel.....	261
Noble-Mayo tijera de diseccion.....	52/1	Partsch martillo.....	271	Petersen-Smith gubia.....	261
Norfolk / Norwich separador.....	172	pasador de tendones Bunell.....	294	Petersen-Smith pinza gubia.....	238
Northbent tijera.....	66	Passow cincel tamponador para huesos.....	260	Petri cubeta.....	620
Norwich / Norfolk separador.....	172	Patella pinza para hueso.....	248	Phaneuf pinza para peritoneo.....	123
Noto pinza para polipos uterinos.....	585	Paton disecador corneal.....	373	Pierce elevador para el tabique nasal.....	438
Nova esfigmomanometro.....	7	Peafood pinza cortante para laminectomia.....	341/1	Pierce trocar para seno maxilar.....	204
Novak cureta aspiradora para biopsia uterina.....	587	Paufique pinza para ligadura.....	392	pieza de acomplamiento para cureta aspiradoras.....	600
Nova-Presameter esfigmomanometro.....	6	Payr pinza intestinal y estomacal.....	548	Piffard cureta para lupus.....	608
Noyes pinza para polipos.....	425	Payr sonda conductora.....	221/1	Pinard estetoscopio.....	23
Noyes tijera para iris.....	75	Payr-Baby pinza intestinal y estomacal.....	548	pinza aplicadora.....	104
		Payr-Schmieden sonda conductora.....	221	pinza aplicadora de clips.....	524, 525
O		Pean pinza hemostatica.....	108, 110	pinza aplicadora McKenzie.....	326
Obwegeser elevador.....	461/1	Pean-DeBaKey pinza hemostatica atraumatica.....	513	pinza aplicadora Olivecrona-Toennis.....	326
Obwegeser gancho de menton.....	461/1	Pean-Rochester pinza hemostatica.....	108	pinza aplicadora Raney.....	327
Obwegeser lezna.....	463, 463/3	Peak pinza cortante para laminectomia.....	341/1	pinza aplicadora Smithwick.....	326
Obwegeser osteotomo.....	463	Peck Joseph tijera face lift.....	73	pinza aplicadora Sweet.....	326
Obwegeser osteotomo de hoja.....	464/1	Pederson espejo vaginal.....	570	pinza aplicadora Toennis-Olivecrona.....	326
Obwegeser periotostotomo.....	462	Peers pinza de campo.....	132	pinza traumatica Cooley.....	99
Obwegeser separador mandibular.....	461/1	Peet escofina nasal.....	446	pinza traumatica DeBaKey.....	98, 99
Obwegeser separador para partes blandas.....	460	Peet pinza para espinas.....	92	pinza traumatica Gregory.....	517
Ochsner pinza de diseccion.....	88	Peikmann pinza porta esponja.....	137	pinza traumatica Hadeo.....	111
Ochsner trocar.....	205	pelvimetro Collier.....	605	pinza traumatica Rogers.....	127
Ochsner-Rochester pinza hemostatica.....	108	pelvimetro Collin.....	605	pinza auricular Harken.....	503
O'Conner gancho para iris.....	375	pelvimetro Martin.....	605	pinza auricular Hartmann.....	411
O'Conner-O'Sullivan espejo vaginal.....	576	Pemberton-Harrington separador.....	147	pinza auricular Littauer.....	411
O'Conner-O'Sullivan separador abdominal.....	181	Penfield elevador para duramadre.....	333	pinza auricular Lucae.....	410
Oehler pinza de diseccion.....	81/1	Pennington elevador para el tabique nasal.....	438	pinza auricular micro.....	413-415
oftalmoscopio May Uni II.....	14	Pennington pinza hemostatica.....	109	pinza auricular micro Cos.....	414
Oldberg pinza cortante para laminectomia.....	341/1	Percy retractor para amputacion.....	296	pinza auricular micro Dieter.....	414
oliva auricular.....	406	perforacraneo Smellie.....	607	pinza auricular micro Greven.....	414
oliva auricular Politzer.....	406	perforador de mano.....	298-300, 304	pinza auricular micro Haugh.....	414
Olivecrona elevador para duramadre.....	332	perforador de mano Bunell.....	299	pinza auricular micro Juers.....	414
Olivecrona espátula cerebral.....	336	perforador de mano Hudson.....	299	pinza auricular micro McGee.....	414
Olivecrona pinza gubia.....	237	perforador de mano Kirschner.....	299	pinza auricular micro Wullstein.....	416
Olivecrona sierra hilo.....	332	perforador de mano Moore.....	298	pinza auricular Tilley.....	411
Olivecrona-Toennis pinza aplicadora.....	326	perforador de mano Raik.....	300	pinza auricular Troeltsch (Wilde).....	410
Ollier separador.....	162	perforador de mano Hadeo.....	300	pinza auricular Wilde (Troeltsch).....	410
Olsen-Hegar porta aguja.....	212	perforador de mano Sherman-Stille.....	298	pinza autocentradora para sostener huesos Hadeo.....	247
Olsen-Mathieu porta aguja.....	212	perforador de mano Stille.....	298	pinza bronquial.....	126
Ombredanne martillo.....	273	perforador de mano Stille-Sherman.....	298	pinza bronquial Finochietto.....	490
O'Shaughnessy-Mixer pinza hemostatica.....	119/2	perforador inicial Crutchfield.....	327	pinza bronquial Harrington.....	490
osteotomo.....	259-267, 464	perforador medular.....	322	pinza bronquial Lees.....	504
osteotomo de hoja Obwegeser.....	464/1	perforador para femur Kuntscher.....	321	pinza bronquial Price-Thomas.....	490
osteotomo Epker.....	464/2	perforador para la cavidad medular Kuntscher.....	321	pinza bronquial Semb.....	491
osteotomo Hibbs.....	265	periotostotomo.....	274-280, 463-464	pinza bronquial Thomas-Price.....	490
osteotomo Hoke.....	265	periotostotomo Alexander.....	276	pinza capsular Arruga.....	391
osteotomo Lambotte.....	261	periotostotomo Alexander-Matson.....	279	pinza capsular Arruga-Gill.....	390
osteotomo Lambotte-Mini.....	262	periotostotomo Cobb.....	280	pinza capsular Castroviejo.....	391
osteotomo Lexer.....	263	periotostotomo Collin-Farabeuf.....	274	pinza capsular Elschmig.....	391
osteotomo Lexer Mini.....	263	periotostotomo Dingman.....	463	pinza capsular Fuchs.....	391
osteotomo Mini Lexer.....	263	periotostotomo Doyen.....	278	pinza capsular Gill-Arruga.....	390
osteotomo Mini-Lambotte.....	262	periotostotomo Farabeuf.....	274	pinza capsular Hess.....	391
osteotomo Obwegeser.....	463	periotostotomo Farabeuf-Collin.....	274	pinza capsular Kalt.....	391
osteotomo Stille.....	260	periotostotomo Fomon.....	277	pinza capsular Schweigger.....	391
Ostroem pinza sacabocado.....	430	periotostotomo Hargis.....	463/2	pinza capsular Terson.....	391
O'Sullivan-O'Conner espejo vaginal.....	576	periotostotomo Joseph.....	277	pinza tierra-tubo.....	129, 130
O'Sullivan-O'Conner separador abdominal.....	181	periotostotomo König.....	276	pinza tierra-tubo Berlin Klinikum.....	129
Otis uretrotomo.....	553	periotostotomo Lambotte.....	274	pinza tierra-tubo Bülow-Gunar-Hey.....	130
otoscopio Uni I.....	13	periotostotomo Langenbeck.....	275	pinza tierra-tubo Gunar-Hey-Bülow.....	130
Overholt pinza hemostatica.....	114	periotostotomo Matson.....	279	pinza tierra-tubo Hey-Bülow-Gunar.....	130

pinza cierra-tubo Klinikum Berlin.....	129	pinza de diseccion Duehrsen.....	84	pinza gubia Ruskin-Stille.....	239
pinza cierra-tubo Presbyterian.....	129	pinza de diseccion Durante.....	88	pinza gubia Sauerbruch.....	240
pinza circular.....	432	pinza de diseccion Duval.....	85	pinza gubia Scaglietti.....	240
pinza cortante Hajek-Kofler.....	429	pinza de diseccion Duval-Collin.....	85	pinza gubia Semb.....	240
pinza cortante Kerrison.....	428	pinza de diseccion Ferris-Smith.....	85	pinza gubia Smith-Petersen.....	238
pinza cortante Kofler-Hajek.....	429	pinza de diseccion Gerald.....	86, 87	pinza gubia Stellbrink.....	234
pinza cortante para hipofisis.....	341	pinza de diseccion Gillies.....	86	pinza gubia Stille (Leksell).....	240
pinza cortante para huesos Böhler.....	241	pinza de diseccion Graefe.....	83	pinza gubia Stille-Luer.....	239
pinza cortante para huesos Cottle-Kazanjan.....	241	pinza de diseccion Lane.....	84	pinza gubia Stille-Ruskin.....	239
pinza cortante para huesos Horsley-Stille.....	242	pinza de diseccion Lerche.....	83	pinza gubia Zaufal-Jansen.....	238
pinza cortante para huesos Kazanjan-Cottle.....	241	pinza de diseccion Mayo.....	89	pinza hemorroidal Heywood-Smith.....	567
pinza cortante para huesos Liston.....	241	pinza de diseccion McIndoe.....	85	pinza hemorroidal Smith-Heywood.....	567
pinza cortante para huesos Liston-Ruskin.....	241	pinza de diseccion modelo ruso.....	85	pinza hemostatica Adson.....	112, 113
pinza cortante para huesos Liston-Stille.....	242	pinza de diseccion modelo Strassburger.....	89	pinza hemostatica Adson Baby.....	113
pinza cortante para huesos McIndoe.....	241	pinza de diseccion Nelson.....	89	pinza hemostatica atraumatica DeBakey-Mosquito.....	509
pinza cortante para huesos Ruskin-Liston.....	241	pinza de diseccion Ochsner.....	88	pinza hemostatica atraumatica DeBakey-Pean.....	513
pinza cortante para huesos Semb.....	242	pinza de diseccion Oehler.....	81/1	pinza hemostatica atraumatica DeBakey-Rankin.....	512
pinza cortante para huesos Stamm.....	241	pinza de diseccion Potts-Smith.....	81, 81/1	pinza hemostatica atraumatica Mosquito-DeBakey.....	509
pinza cortante para huesos Stille-Horsley.....	242	pinza de diseccion Semken.....	86	pinza hemostatica atraumatica Pean-DeBakey.....	513
pinza cortante para huesos Stille-Liston.....	242	pinza de diseccion Singley.....	88	pinza hemostatica atraumatica Rankin-DeBakey.....	512
pinza cortante para laminectomia Cloward.....	342	pinza de diseccion Smith-Ferris.....	85	pinza hemostatica Baby Adson.....	113
pinza cortante para laminectomia Cushing.....	340	pinza de diseccion Smith-Potts.....	81, 81/1	pinza hemostatica Baby Mixer.....	119/1
pinza cortante para laminectomia Decker.....	341	pinza de diseccion Standard.....	81, 81/1	pinza hemostatica Baby-Overholt.....	114
pinza cortante para laminectomia Ferris-Smith.....	343	pinza de diseccion Stille.....	81, 81/1	pinza hemostatica Bainbridge.....	119/2
pinza cortante para laminectomia Gruenwald-Love.....	340	pinza de diseccion Stille-Barraya.....	88	pinza hemostatica Bengolosa.....	112
pinza cortante para laminectomia Love-Gruenwald.....	340	pinza de diseccion Taylor.....	87	pinza hemostatica Birkett.....	116
pinza cortante para laminectomia Oldberg.....	341/1	pinza de diseccion Taylor-Cushing.....	87	pinza hemostatica Bridge.....	116
pinza cortante para laminectomia Peapod.....	341/1	pinza de diseccion Taylor USA.....	81, 81/1	pinza hemostatica Crafoord-Rochester.....	109
pinza cortante para laminectomia Schlesinger.....	342	pinza de diseccion Wagensteen.....	89	pinza hemostatica Chaput.....	110
pinza cortante para laminectomia Smith-Ferris.....	343	pinza de diseccion Waugh.....	83	pinza hemostatica Collier-Crile.....	106
pinza cortante para laminectomia Spurling.....	340	pinza de proteccion Adson.....	298	pinza hemostatica Collin.....	110
pinza cortante para laminectomia Wagner.....	343	pinza de reduccion Hadeo.....	247	pinza hemostatica Crafoord.....	118
pinza cuticular.....	610	pinza de relojero.....	90	pinza hemostatica Crafoord-Sellors.....	119
pinza de agarre.....	305	pinza de rodillos.....	131	pinza hemostatica Crile.....	107
pinza de agarre para capsula Millin.....	292-294, 550, 551	pinza de traccion craneal Crutchfield.....	327	pinza hemostatica Crile-Coller.....	106
pinza de agarre para prostata Young.....	550	pinza dental College-London.....	93	pinza hemostatica Crile-Rankin.....	107
pinza de agarre para tendones.....	292, 293	pinza dental London-College.....	93	pinza hemostatica Dandy.....	109
pinza de agarre para tendones Brand.....	293	pinza dental Meriam.....	93	pinza hemostatica Desjardins.....	121
pinza de agarre para tendones Caroll.....	293	pinza depiladora Barraquer.....	395	pinza hemostatica Fergusson.....	109
pinza de agarre para tendones Jackson.....	292	pinza depiladora Beer.....	395	pinza hemostatica Fuchsig.....	113
pinza de agarre para tendones Kleinert-Kutz.....	294	pinza depiladora Douglas.....	395	pinza hemostatica Geissendoerfer-Overholt.....	114
pinza de agarre para tendones Kutz-Kleinert.....	294	pinza depiladora Gradle.....	395	pinza hemostatica Gemini.....	115
pinza de agarre para tendones Steinmann.....	292	pinza depiladora Littauer.....	395	pinza hemostatica Gray.....	121
pinza de aplicacion.....	357-360	pinza depiladora Hadeo.....	395	pinza hemostatica Guyon.....	122
pinza de campo.....	132, 133	pinza estomacal Lane.....	547	pinza hemostatica Guyon-Mayo.....	122
pinza de campo Backhaus.....	132	pinza gubia Adson.....	236	pinza hemostatica Halsted-Mosquito.....	105
pinza de campo Backhaus-Clip.....	132	pinza gubia Bane-Hartmann.....	237	pinza hemostatica Hartmann.....	104
pinza de campo Bernhard.....	133	pinza gubia Beyer.....	237, 238	pinza hemostatica Heiss.....	112
pinza de campo Clip-Backhaus.....	132	pinza gubia Blumenthal.....	236	pinza hemostatica Hopkins-Johns.....	120
pinza de campo Clip-Jones.....	132	pinza gubia Böhler.....	238	pinza hemostatica Hospital-Providence.....	106
pinza de campo Doyen.....	133	pinza gubia Cleveland.....	235	pinza hemostatica Johns-Hopkins.....	120
pinza de campo Jones.....	132	pinza gubia Echlin.....	240	pinza hemostatica Kantrowitz.....	119/1
pinza de campo Jones-Clip.....	132	pinza gubia Friedmann.....	234	pinza hemostatica Kelly.....	106
pinza de campo Lane.....	133	pinza gubia Friedmann Micro.....	234	pinza hemostatica Kelly-Rankin.....	106
pinza de campo Moynihan.....	133	pinza gubia Friedmann Mini.....	234	pinza hemostatica Kocher.....	108
pinza de campo Peers.....	132	pinza gubia Frykholm.....	240	pinza hemostatica Lahey.....	119/2, 120
pinza de campo Roeder.....	132	pinza gubia Hartmann-Bane.....	237	pinza hemostatica Lawrence.....	119
pinza de campo Schaedel.....	132	pinza gubia Jansen.....	237	pinza hemostatica Leriche.....	111
pinza de campo Tohoku.....	132	pinza gubia Jansen-Zaufal.....	238	pinza hemostatica Lovelace.....	109
pinza de diseccion.....	81-89	pinza gubia Kleinert-Kutz.....	237	pinza hemostatica Lower.....	120
pinza de diseccion Adlerkreutz.....	84	pinza gubia Kutz-Kleinert.....	237	pinza hemostatica Martel.....	110
pinza de diseccion Adson.....	81/2, 82	pinza gubia Leksell (Stille).....	240	pinza hemostatica Martel Willet.....	110
pinza de diseccion Adson-Brown.....	82	pinza gubia Lempert.....	237	pinza hemostatica Mayo-Guyon.....	122
pinza de diseccion Adson-DeBakey.....	81/2	pinza gubia Luer.....	236	pinza hemostatica Meeker.....	119
pinza de diseccion Barraya-Stille.....	88	pinza gubia Luer-Stille.....	239	pinza hemostatica Mixer.....	116, 119/1-120
pinza de diseccion Bonney.....	88	pinza gubia Marquardt.....	239	pinza hemostatica Mixer Baby.....	119/1
pinza de diseccion Brophy.....	84	pinza gubia Mayfield.....	238	pinza hemostatica Mixer-O'Shaughnessy.....	119/2
pinza de diseccion Brown.....	83	pinza gubia Mead.....	235	pinza hemostatica Mixer-Overholt.....	115
pinza de diseccion Brown-Adson.....	82	pinza gubia Micro Friedmann.....	234	pinza hemostatica Mosquito-Halsted.....	105
pinza de diseccion Collin-Duval.....	85	pinza gubia Mini Friedmann.....	234	pinza hemostatica Moynihan.....	120
pinza de diseccion Cushing.....	83	pinza gubia Olivecrona.....	237	pinza hemostatica Nissen.....	113
pinza de diseccion Cushing-Taylor.....	87	pinza gubia Petersen-Smith.....	238	pinza hemostatica Ochsner-Rochester.....	108
pinza de diseccion DeBakey-Adson.....	81/2	pinza gubia Ruskin.....	239	pinza hemostatica O'Shaughnessy-Mixer.....	119/2

pinza hemostatica Overholt	114	pinza nasal Jansen	424	pinza para biopsia Townsend.....	591
pinza hemostatica Overholt-Baby.....	114	pinza nasal Jansen-Gruenwald	424	pinza para biopsia Townsend-Down-Mini.....	591
pinza hemostatica Overholt-Geissendoerfer.....	114	pinza nasal Knight.....	425	pinza para biopsia Townsend-Up-Mini.....	591
pinza hemostatica Overholt-Mixter	115	pinza nasal Knight-Heymann	425	pinza para biopsia Turrel	567
pinza hemostatica Pean.....	108, 110	pinza nasal Lubet-Barbon	424	pinza para biopsia Up-Mini-Townsend	591
pinza hemostatica Pean-Rochester	108	pinza nasal Luc	426	pinza para biopsia Up-Tischler	591
pinza hemostatica Pennington	109	pinza nasal Myles.....	427	pinza para biopsia Van Doren	588
pinza hemostatica Pratt	110	pinza nasal Schmeden	427	pinza para biopsia Wittner	589
pinza hemostatica Providence-Hospital	106	pinza nasal Struycken	427	pinza para biopsia Yeoman	566, 567
pinza hemostatica Rankin-Crile	107	pinza nasal Takahashi	427	pinza para calculos esofagogoscopia Chevalier-Jackson.....	473
pinza hemostatica Rankin-Kelly.....	106	pinza nasal Troeltsch.....	424	pinza para bronco-esofagogoscopia Jackson-Chevalier	473
pinza hemostatica Roberts	117	pinza nasal Watson-Williams.....	428	pinza para calculos biliares Blake.....	530/2
pinza hemostatica Rochester-Carmalt.....	109	pinza nasal Weil-Blakesley.....	426	pinza para calculos biliares Blake-Mayo	530/2
pinza hemostatica Rochester-Ochsner	108	pinza nasal Westmacott	424	pinza para calculos biliares Desjardins	530/2
pinza hemostatica Rochester-Pean	108	pinza nasal Williams-Watson.....	428	pinza para calculos biliares Mayo-Blake	530/2
pinza hemostatica Rumel.....	117	pinza para aborto Saenger.....	606	pinza para calculos biliares Mixter.....	530/2
pinza hemostatica Sarot.....	118	pinza para aborto Winter.....	606	pinza para calculos renales Heiming	536
pinza hemostatica Sellors-Crafoord.....	119	pinza para agarrar el bocio Lahey.....	479	pinza para calculos renales Randall.....	535
pinza hemostatica Spencer-Wells	109	pinza para amigdalas Marschik	468	pinza para cambiar hojas.....	179
pinza hemostatica Stille	122	pinza para anastomosis Beck	516, 520	pinza para campo Ball and Socket	133
pinza hemostatica Toennis.....	117	pinza para anastomosis Cooley	519-520/4	pinza para campo Lorna	133
pinza hemostatica Tuffier	110	pinza para anastomosis Cooley-Derra.....	519	pinza para campo Socket and Ball.....	133
pinza hemostatica Wells-Spencer	109	pinza para anastomosis DeBaKey.....	505, 515	pinza para capsuloridectom Holth	380
pinza hemostatica Wikstroem	117	pinza para anastomosis DeMartel-Wolfson	546	pinza para cartilagos Martin	246
pinza hemostatica Willet Martel	110	pinza para anastomosis Derra	515	pinza para cateter Cooley	510
pinza hemostatica Zenker	118	pinza para anastomosis Derra-Cooley.....	519	pinza para cerrar clamps DeMartel-Wolfson	546
pinza intestinal Adair-Allis	537	pinza para anastomosis Hayes	545	pinza para cerrar clamps Stone	545
pinza intestinal Allis	537	pinza para anastomosis Kay-Lambert	505	pinza para cerrar clamps Wolfson-DeMartel	546
pinza intestinal Allis-Adair.....	537	pinza para anastomosis Lambert-Kay.....	505	pinza para chalazion Desmarres	393
pinza intestinal Allis-Baby	537	pinza para anastomosis Potts.....	493	pinza para chalazion Lambert	393
pinza intestinal Allis-Boys	538	pinza para anastomosis Wolfson-DeMartel	546	pinza para coatacion Potts.....	492
pinza intestinal Allis-Judd	538	pinza para aneurisma Bahnon-DeBaKey.....	506	pinza para coger amigdalas Abraham	468
pinza intestinal Allis-Lockwood	538	pinza para aneurisma de la aorta DeBaKey.....	496-498	pinza para coger amigdalas Ballenger	467
pinza intestinal Allis-Thoms	538	pinza para aneurisma DeBaKey-Bahnon	506	pinza para coger amigdalas Blohmke.....	467
pinza intestinal Babcock	539	pinza para aorta Cooley.....	520/3	pinza para coger amigdalas Colver	467
pinza intestinal Baby-Allis	537	pinza para apendice Allen	544	pinza para coger amigdalas Negus	467
pinza intestinal Baby-Doyen	540	pinza para apendice Kleinschmidt	544	pinza para coger amigdalas Sawtell	467
pinza intestinal Baby-Kocher	540	pinza para aplicar agrafes Childe	224	pinza para coger amigdalas Schmidt	467
pinza intestinal Boys-Allis	538	pinza para aplicar agrafes Hegenbarth	224	pinza para coger amigdalas Tyding	468
pinza intestinal Brunner	543	pinza para aplicar agrafes Michel	224	pinza para coger amigdalas White.....	467
pinza intestinal Doyen	540	pinza para aplicar agrafes Wachenfeldt	224	pinza para coger el pulmon Lovelace.....	490
pinza intestinal Doyen-Baby	540	pinza para aplicar y quitar agrafes Michel	224	pinza para columna Cottle	448
pinza intestinal Fehland	542	pinza para arrancar uñas Radolf	297	pinza para cordon espermatico	553/2
pinza intestinal Gregoire.....	538	pinza para arrancar vendaje enyesado Wolff	233	pinza para cuerpos extraños Mathieu	553/1
pinza intestinal Judd-Allis	538	pinza para biopsia Alexander.....	589	pinza para desechos Sauerbruch	227
pinza intestinal Kocher.....	540	pinza para biopsia Baby Burke	590	pinza para el pene Stockmann	553/1
pinza intestinal Kocher-Baby	540	pinza para biopsia Baby-Tischler.....	592	pinza para el pene Strauss	553/1
pinza intestinal Littlewood.....	538	pinza para biopsia Burke	590	pinza para el tunel del tendon	293
pinza intestinal Lockwood-Allis.....	538	pinza para biopsia Burke Baby	590	pinza para el utero Collin	585
pinza intestinal Mayo-Robson	541	pinza para biopsia Down-Mini-Townsend.....	591	pinza para el utero Dartigues	585
pinza intestinal Mikulicz	543	pinza para biopsia Down-Tischler.....	591	pinza para el utero Somer	585
pinza intestinal Resano	542	pinza para biopsia Eppendorfer	590	pinza para enderezar el tabique nasal Asch.....	449
pinza intestinal Robson-Mayo.....	541	pinza para biopsia Faure.....	588	pinza para enderezar el tabique nasal Walsham	449
pinza intestinal Scudder	541	pinza para biopsia Gaylor-Thomas	588	pinza para espinas	91, 92
pinza intestinal Stone-Watt	545	pinza para biopsia Gaylor-Thomas	588	pinza para espinas Archer.....	92
pinza intestinal Thoms-Allis.....	538	pinza para biopsia Grasper Maxi	593	pinza para espinas Carmalt.....	91
pinza intestinal Watt-Stone	545	pinza para biopsia Grasper Serpentine	593	pinza para espinas Kevorkian	91
pinza intestinal y estomacal Baby-Payr.....	548	pinza para biopsia Kevorkian	589, 591	pinza para espinas Felchenfeld	91
pinza intestinal y estomacal Payr.....	548	pinza para biopsia Kevorkian-Pacific.....	592	pinza para espinas Hunter	91
pinza intestinal y estomacal Payr-Baby.....	548	pinza para biopsia Kevorkian-Tischler.....	592	pinza para espinas Peet.....	92
pinza maleolar	247	pinza para biopsia Maxi Grasper	593	pinza para espinas Stieglitz	92
pinza monopolares	634	pinza para biopsia Mini-Townsend-Down.....	591	pinza para esterilizacion	227
pinza muscular Berke.....	389	pinza para biopsia Mini-Townsend-Up	591	pinza para esterilizacion Cheatle	227
pinza muscular Mastin	479	pinza para biopsia Morgan-Tischler.....	590, 591	pinza para esterilizacion de jeringas Davis	227
pinza muscular Prince.....	386	pinza para biopsia Pacific-Kevorkian.....	592	pinza para esterilizacion Rogge	227
pinza muscular Snellen	393	pinza para biopsia Schubert	588	pinza para esterilizacion Universal	227
pinza nasal Barbon-Lubet.....	424	pinza para biopsia Schumacher	588, 589	pinza para estrabismo Bonaccolto	385
pinza nasal Blakesley-Weil.....	426	pinza para biopsia Serpentine Grasper	593	pinza para estrabismo Dastoor	386
pinza nasal Bruenings	425	pinza para biopsia Thomas-Gaylor.....	588	pinza para estrabismo Jameson	385
pinza nasal Gruenwald-Jansen	424	pinza para biopsia Tischler-Baby	592	pinza para estrabismo McCullough	385
pinza nasal Hartmann	424, 427	pinza para biopsia Tischler-Down	591	pinza para fijacion Arthur-Kirby	385
pinza nasal Heymann	425	pinza para biopsia Tischler-Kevorkian.....	592	pinza para fijacion Barraquer	390
pinza nasal Heymann-Knight	425	pinza para biopsia Tischler-Morgan	590, 591	pinza para fijacion Castroviejo	390
		pinza para biopsia Tischler-Up	591	pinza para fijacion Cottle	410

pinza para fijacion Elschmig.....	389	pinza para ligadura Ayer.....	393	pinza para tracoma Knapp-Luer.....	393
pinza para fijacion Graefe.....	389	pinza para ligadura DeBakey.....	493, 499-500	pinza para tracoma Luer-Knapp.....	393
pinza para fijacion Green.....	390	pinza para ligadura McPherson.....	392	pinza para tumores Landolt.....	341/2
pinza para fijacion Kirby-Arthur.....	385	pinza para ligadura Millin.....	551	pinza para tumores Yasargil.....	97
pinza para fijacion Lester.....	389	pinza para ligadura Mod. Tübingen.....	392	pinza para uso multiple Glover.....	515
pinza para hemorroides McGivney.....	568	pinza para ligadura Pauflue.....	392	pinza para uterus Armytage-Green.....	605
pinza para hipofisis Adson.....	334	pinza para ligadura Tübingen Mod.....	392	pinza para uterus Green-Armytage.....	605
pinza para histerectomia Ballentine-Heany.....	127	pinza para ligadura y la aorta DeBakey-Semb.....	499	pinza para vasectomia.....	553/2
pinza para histerectomia Cullen-Wertheim.....	125	pinza para ligadura y la aorta Semb-DeBakey.....	499	pinza para vasos Biemer.....	361
pinza para histerectomia Heaney.....	126	pinza para ligaduras DeBakey-Mixer.....	499/2	pinza para vasos Mehdorn.....	362
pinza para histerectomia Heany-Ballentine.....	127	pinza para ligaduras DeBakey-Rumel.....	499	pinza para vasos perifericos Dale.....	494, 495
pinza para histerectomia Holzbach.....	126	pinza para ligaduras Mixer-DeBakey.....	499/2	pinza para vasos perifericos DeBakey.....	494
pinza para histerectomia Landau-Segond.....	125	pinza para ligaduras Rumel-DeBakey.....	499	pinza para vasos perifericos Jones-Leland.....	495
pinza para histerectomia Maingot.....	123/1, 123/2	pinza para lobo anterior Millin.....	551	pinza para vasos perifericos Leland-Jones.....	495
pinza para histerectomia Segond.....	125	pinza para magullar tabique Rubin.....	428	pinza para vasos Satinsky.....	491
pinza para histerectomia Wertheim.....	124, 128	pinza para medicacion Bryant.....	137	pinza pico plano.....	317, 320
pinza para histerectomia Wertheim-Cullen.....	125	pinza para microcirugia.....	96	pinza porta esponja Bozemann.....	138
pinza para hueso Bircher-Ganske.....	246	pinza para micro-cirugia de la laringe.....	474	pinza porta esponja Bozemann-Douglas.....	138
pinza para hueso Dingmann.....	246	pinza para oclusion tangencial DeBakey-Satinsky.....	502	pinza porta esponja Cheron.....	137
pinza para hueso Farabeuf.....	243	pinza para oclusion tangencial Satinsky-DeBakey.....	502	pinza porta esponja Collin.....	137
pinza para hueso Farabeuf-Lambotte.....	243	pinza para parametrio.....	128/1	pinza porta esponja Douglas-Bozemann.....	138
pinza para hueso Fergusson.....	243	pinza para parametrio Hadeo.....	128/1	pinza porta esponja Lister (Sinus).....	137
pinza para hueso Ganske-Bircher.....	246	pinza para pediculo Herrick.....	123	pinza porta esponja Pelkmann.....	137
pinza para hueso Kern.....	244	pinza para pericraneo Gauss.....	605	pinza porta esponja Sinus (Lister).....	137
pinza para hueso Lambotte.....	244	pinza para peritoneo Faure.....	123	pinza porta-esponja Duplay.....	134
pinza para hueso Lambotte-Farabeuf.....	243	pinza para peritoneo Mikulicz.....	123	pinza porta-esponja Gross-Maier.....	134
pinza para hueso Lane.....	244	pinza para peritoneo Phaneuf.....	123	pinza porta-esponja Maier-Gross.....	134
pinza para hueso Langenbeck.....	243	pinza para polipos Hartmann.....	412	pinza porta-esponja Lister (Sinus).....	134
pinza para hueso Lewin.....	246	pinza para polipos Hartmann-Hoffmann.....	412	pinza porta-esponja Sims-Maier.....	134
pinza para hueso Patella.....	248	pinza para polipos Hartmann-Wullstein.....	412	pinza sacabocado Citelli.....	430
pinza para hueso Hadeo.....	246	pinza para polipos Hoffmann-Hartmann.....	412	pinza sacabocado craneal Cone.....	331
pinza para hueso Reill.....	248	pinza para polipos laringeos Jurasz.....	471	pinza sacabocado craneal DeVilbiss.....	332
pinza para hueso Semb.....	243	pinza para polipos Littauer.....	425	pinza sacabocado Hajek-Kofler.....	431
pinza para hueso Ulrich.....	248	pinza para polipos Noyes.....	425	pinza sacabocado Kofler-Hajek.....	431
pinza para hueso Verbrugge.....	245	pinza para polipos Struempel.....	412	pinza sacabocado Ostroem.....	430
pinza para huesos.....	243-250	pinza para polipos uterinos Doyen.....	585	pinza sacabocado para discos intervertebral Colclough.....	344/1
pinza para huesos autocentrantes.....	245	pinza para polipos uterinos Kelly.....	585	pinza sacabocado para discos intervertebral Ferris-Smith-Kerrison.....	344, 344/2
pinza para huesos Feldheim.....	249	pinza para polipos uterinos Noto.....	585	pinza sacabocado para discos intervertebral Kerrison-Ferris-Smith.....	344, 344/2
pinza para huesos Hoglund-Lowman.....	249	pinza para polipos Wullstein-Hartmann.....	412	pinza sacabocado para discos intervertebral Smith-Kerrison-Ferris.....	344, 344/2
pinza para huesos Lambert-Lowman.....	249	pinza para quitar agrafes Collin.....	224	pinza Smith.....	463
pinza para huesos Lowman.....	249	pinza para quitar agrafes Heath-Richter.....	224	pinza tira-lengua Collin.....	453
pinza para huesos Lowman-Hoglund.....	249	pinza para quitar agrafes Richter-Heath.....	224	pinza tira-lengua Young.....	453
pinza para huesos Lowman-Lambert.....	249	pinza para reduction.....	246	pinza Ultra-Ligera.....	95
pinza para huesos Meyer.....	248	pinza para reposicion Rowe.....	459	pinza uterina Adair.....	582
pinza para introducir cateter Magill.....	28	pinza para secuestros.....	249	pinza uterina Barrett.....	582
pinza para iris Barraquer (Colibri).....	384	pinza para secuestros Van Buren.....	249	pinza uterina Braun.....	582
pinza para iris Barraquer-Katzin.....	384	pinza para senoscopia.....	431	pinza uterina Czerny.....	584
pinza para iris Bishop-Harman.....	386	pinza para separar la rama Smith.....	463	pinza uterina Duplay.....	582
pinza para iris Colibri.....	384	pinza para shunt carotido Javid.....	511	pinza uterina Hulka.....	583
pinza para iris Colibri (Barraquer).....	384	pinza para sostener placas Lane.....	325	pinza uterina Iowa.....	584
pinza para iris Colibri (Troutman).....	384	pinza para sostener tornillos Lane.....	325	pinza uterina Jacobs.....	583
pinza para iris Fischer.....	384	pinza para sutura Bonn Mod.....	386	pinza uterina Jarcho.....	583
pinza para iris Foerster.....	383	pinza para sutura Castroviejo.....	392	pinza uterina Moore-Staude.....	582
pinza para iris Gill.....	384	pinza para sutura Mod. Bonn.....	386	pinza uterina Museux.....	583
pinza para iris Gill-Hess.....	384	pinza para sutura Tübingen.....	392	pinza uterina Palmer-Pozzi.....	582
pinza para iris Graefe.....	382	pinza para sutura Moorfield.....	392	pinza uterina Palmer-Pozzi.....	582
pinza para iris Harman-Bishop.....	386	pinza para sutura St. Martin.....	392	pinza uterina Pozzi (Schroeder).....	582
pinza para iris Hess.....	384	pinza para sutura Tübingen Mod.....	386	pinza uterina Pozzi-Palmer.....	582
pinza para iris Hess-Gill.....	384	pinza para tabique nasal Graig.....	426	pinza uterina Pratt.....	584
pinza para iris Hess-Bishop.....	384	pinza para tabique nasal Jansen-Middleton.....	430	pinza uterina Schröder.....	584
pinza para iris Stevens.....	383	pinza para tabique nasal Middleton-Jansen.....	430	pinza uterina Schroeder.....	583
pinza para iris Troutman.....	389	pinza para tapones.....	135, 471	pinza uterina Schroeder (Pozzi).....	582
pinza para iris Troutman (Colibri).....	384	pinza para tapones Jackson.....	471	pinza uterina Skene.....	582
pinza para la aorta DeBakey-Morris.....	506	pinza para tapones Ulrich.....	135	pinza uterina Staude-Moore.....	582
pinza para la aorta Dietrich.....	510	pinza para tejido Collin.....	539	pinza uterina Teale.....	583
pinza para la aorta Miniature-Subramanian.....	521	pinza para tejido Duval.....	539	pinza vascular Cooley.....	520
pinza para la aorta Morris-DeBakey.....	506	pinza para tejido Williams.....	539	pinza vascular Dardik.....	509/1
pinza para la aorta Subramanian.....	521	pinza para tendones Larsen.....	292	pinza vascular de uso multiple Bainbridge.....	495/1-495/2
pinza para la aorta Subramanian-Miniature.....	521	pinza para torcer hilo Berry.....	319	pinza vascular de uso multiple Cooley.....	518-520, 520/2
pinza para la aorta Weber.....	501	pinza para torcer hilo Corwin-Hegar.....	319		
pinza para la aorta Wylie.....	501/1, 501/2	pinza para torcer hilo Haberisser-Mayo.....	319		
pinza para laringe Fraenkel.....	471	pinza para torcer hilo Hegar-Corwin.....	319		
		pinza para torcer hilo Mayo-Haberisser.....	319		

pinza vascular de uso multiple DeBaKey.....	495/2, 507, 508, 514, 515	pinza vascular Neonatal.....	523	pinza vascular para neontales Castaneda.....	527	pinza vascular pediátrica Cooley.....	522	pinza vascular pediátrica DeBaKey.....	516, 517	Piper forceps obstétrico.....	604	Pistola lavadora.....	626	placa para extender la piel.....	49	placa para parpado Jaeger.....	371	Plester cuchillo.....	418	Plester separador.....	171	Plester tubo de aspiracion.....	338	polipotomo Krause.....	433/2	polipotomo Krause-Voss.....	433/2	polipotomo Voss-Krause.....	433/2	polipotomo Wilde.....	433/2	Politzer aguja para paracentesis.....	408	Politzer cuchillo auricular.....	408	Politzer espejuelo auricular.....	399	Politzer oliva auricular.....	406	Poole tubo de aspiracion.....	27	porta aguja (micro) Barraquer.....	216, 217	porta aguja (micro) Barraquer-Troutmann.....	216	porta aguja (micro) Castroviejo-Standard.....	216	porta aguja (micro) Standard-Castroviejo.....	216	porta aguja (micro) Troutmann-Barraquer.....	216	porta aguja Adson.....	211	porta aguja Arruga.....	214	porta aguja Arruga-Kalt.....	214	porta aguja Baby-Olsen-Hegar.....	212	porta aguja Baumgartner.....	208	porta aguja Boomerang Young.....	220	porta aguja Boynton.....	214	porta aguja Bozemann.....	211	porta aguja Brown.....	209	porta aguja Castroviejo.....	215	porta aguja Castroviejo-Micro.....	215	porta aguja Collier.....	208	porta aguja Crile.....	213	porta aguja Crile-Murray.....	209	porta aguja Crile-Wood.....	209	porta aguja DeBaKey.....	210	porta aguja Derf.....	208	porta aguja Finochietto.....	211	porta aguja Gillies.....	212	porta aguja Halsey.....	208	porta aguja Heaney.....	210	porta aguja Hegar-Baby-Olsen.....	212	porta aguja Hegar-Mayo.....	209	porta aguja Hegar-Olsen.....	212	porta aguja Hoesel.....	213	porta aguja Jacobsen.....	215	porta aguja Johnson.....	211	porta aguja Kalt.....	214	porta aguja Kalt-Arruga.....	214	porta aguja Kilner.....	212	porta aguja Langenbeck.....	213	porta aguja Lichtenberg.....	213	porta aguja Masson.....	210	porta aguja Mathieu.....	213	porta aguja Mathieu-Olsen.....	212	porta aguja Mayo-Hegar.....	209	porta aguja Metzbaum.....	211	porta aguja Micro-Castroviejo.....	215	porta aguja Microvascular.....	210	porta aguja Murray-Crile.....	209	porta aguja Neivert.....	208	porta aguja Olsen-Hegar.....	212	porta aguja Olsen-Hegar-Baby.....	212	porta aguja Olsen-Mathieu.....	212	porta aguja Ryder.....	210	porta aguja Sarot.....	211	porta aguja Stevens.....	214	porta aguja Stratte.....	212	porta aguja Wangenstein.....	210	porta aguja Webster.....	208	porta aguja Wood-Crile.....	209	porta aguja Young Boomerang.....	220	porta esponjas Foerster.....	136	porta esponjas Rampley.....	136	porta ligadura para tourniquete.....	528	porta pinza de traslado.....	615	porta-algodon.....	203	porta-algodon Farrell.....	203	porta-algodon Home-Jobson.....	203	porta-algodon Jobson-Home.....	203	porta-algodon Hadeo.....	203	porta-algodon Tobold.....	203	porta-algodon Uckermann.....	203	porta-clamps DeMartel-Wolfson.....	546	porta-clamps Wolfson-DeMartel.....	546	portador de luz fria Kleinsasser.....	36	portador de luz Holinger.....	37	portador de luz Jackson.....	37	Potts pinza para anastomosis.....	493	Potts pinza para coartacion.....	492	Potts-DeMartel tijera vascular.....	59	Potts-Smith pinza de diseccion.....	81, 81/1	Potts-Smith tijera vascular.....	61	Pozzi (Schroeder) pinza uterina.....	582	Pozzi-Palmer pinza uterina.....	582	Pratt dilatador uterino.....	580	Pratt espejuelo rectal.....	559	Pratt pinza hemostatica.....	110	Pratt pinza uterina.....	584	Pratt sonda para fistula.....	563	Precisa esfigmomanometro.....	9	Presameter-Nova esfigmomanometro.....	6	Presbyterian pinza cierra-tubo.....	129	Price-Thomas pinza bronquial.....	490	Prince pinza muscular.....	386	Prince tijera para amigdalas.....	59	protoscopio Bensaude.....	565	protoscopio Fansler.....	564	protoscopio Kelly.....	562, 563	protoscopio Morgan.....	565	protector Arruga.....	378	Providence-Hospital pinza hemostatica.....	106	punta de pinza Baracani.....	472	punta de pinza Bruenings.....	472	punta de pinza Cordes.....	472	punta de pinza Fraenkel.....	472	punta de pinza Krause.....	472	punta de pinza Lange.....	472	punta de pinza Scheinmann.....	472	punta de pinza Schumacher.....	472	punta de pinza Seifert.....	472	Putti lima para huesos.....	294	Pynchon-Andrew tubo de aspiracion.....	28	Q	Quervain periototomo.....	275	Quinby tijera para encias.....	67	Quire elevador para cuerpos extraños.....	412	Quising martillo.....	271	quistotomo Becker.....	375	quistotomo Graefe.....	375	quita hojas.....	42	R	Radolf pinza para arrancar uñas.....	297	Ragnell separador.....	140	Ragnell/Kilner tijera supercut.....	72	Ralk perforador de mano.....	300	Rampley porta esponjas.....	136	Ramus separador para el ramo.....	461	Randall cureta aspiradora para biopsia uterina.....	587	Randall pinza para calculos renales.....	535	Raney grapa para cuero cabelludo.....	327	Raney pinza aplicadora.....	327	Rankin-Crile pinza hemostatica.....	107	Rankin-DeBaKey pinza hemostatica atraumatica.....	512	Rankin-Kelly pinza hemostatica.....	106	raquiotomo.....	267	Ray cureta para hipofisis.....	334	Recamier cureta uterina.....	597	Hadeo cucharilla cortante.....	256	Hadeo cuchillo de hoz.....	435	Hadeo cuchillo para amputacion.....	44	Hadeo diapasón.....	403	Hadeo espejuelo nasal.....	423	Hadeo Excenter tijera para vendaje.....	69/2	Hadeo gancho.....	150	Hadeo iman ocular.....	395	Hadeo instrumento para vendaje enyesado.....	232	Hadeo micro tijera.....	77, 80	Hadeo perforador de mano.....	300	Hadeo pinza atraumatica.....	111	Hadeo pinza autocentradora para sostener huesos.....	247	Hadeo pinza de reduction.....	247	Hadeo pinza depilatoria.....	395	Hadeo pinza para hueso.....	246	Hadeo pinza para parametrio.....	128/1	Hadeo porta-algodon.....	203	Hadeo rompe hojas.....	45	Hadeo siera para abrir anillos.....	297	Hadeo sonda conductora.....	221/1	Redon aguja de guia.....	207	Rees tijera face lift.....	73	regla.....	25	Reichert depresor para epiglottis.....	471	Reill pinza para hueso.....	248	Reiner cuchillo para vendaje enyesado.....	233	Reiner jeringa auricular.....	406	Reinke-Lopez elevador para amigdalas.....	465	Resano pinza intestinal.....	542	Resano tijera para capsula.....	53/2	retractor nasal Aufrecht.....	447	retractor nasal Cottle.....	447, 447/1	retractor nasal Kilner.....	447/1	retractor nasal Masing.....	447	retractor nasal Masing-Neivert.....	447	retractor nasal Neivert-Masing.....	447	retractor para amputacion Percy.....	296	Reverdin aguja.....	220	Reverdin separador abdominal.....	143/3	Reynolds tijera para cirugia.....	54/1	Reynolds tijera supercut.....	72	Ribbon espátula abdominal.....	143/1	Ricard separador abdominal.....	191	Richardson Grip separador.....	142	Richardson separador.....	142	Richardson-Eastman separador.....	142	Richnau-Holmgren espejuelo auricular.....	400	Richter-Heath pinza para quitar agrafes.....	224	Rienhoff-Finochietto separador costal.....	486	Rigby separador.....	189/2	Ri-Mini estuche de diagnostico.....	17	Ring baja-lengua.....	455	riñoneras.....	619	Ritter-Halle dilatador para el seno.....	433	Robb disecador vascular.....	530	Robb espátula para la intima.....	530	Roberts pinza hemostatica.....	117	Robson-Mayo pinza intestinal.....	541	Rochard separador abdominal.....	186	Rochester-Carmalt pinza hemostatica.....	109	Rochester-Ochsner pinza hemostatica.....	108
---	---------------------------	------------------------------	-----	--	-----	---------------------------------------	-----	--	----------	-------------------------------	-----	-----------------------	-----	----------------------------------	----	--------------------------------	-----	-----------------------	-----	------------------------	-----	---------------------------------	-----	------------------------	-------	-----------------------------	-------	-----------------------------	-------	-----------------------	-------	---------------------------------------	-----	----------------------------------	-----	-----------------------------------	-----	-------------------------------	-----	-------------------------------	----	------------------------------------	----------	--	-----	---	-----	---	-----	--	-----	------------------------	-----	-------------------------	-----	------------------------------	-----	-----------------------------------	-----	------------------------------	-----	----------------------------------	-----	--------------------------	-----	---------------------------	-----	------------------------	-----	------------------------------	-----	------------------------------------	-----	--------------------------	-----	------------------------	-----	-------------------------------	-----	-----------------------------	-----	--------------------------	-----	-----------------------	-----	------------------------------	-----	--------------------------	-----	-------------------------	-----	-------------------------	-----	-----------------------------------	-----	-----------------------------	-----	------------------------------	-----	-------------------------	-----	---------------------------	-----	--------------------------	-----	-----------------------	-----	------------------------------	-----	-------------------------	-----	-----------------------------	-----	------------------------------	-----	-------------------------	-----	--------------------------	-----	--------------------------------	-----	-----------------------------	-----	---------------------------	-----	------------------------------------	-----	--------------------------------	-----	-------------------------------	-----	--------------------------	-----	------------------------------	-----	-----------------------------------	-----	--------------------------------	-----	------------------------	-----	------------------------	-----	--------------------------	-----	--------------------------	-----	------------------------------	-----	--------------------------	-----	-----------------------------	-----	----------------------------------	-----	------------------------------	-----	-----------------------------	-----	--------------------------------------	-----	------------------------------	-----	--------------------	-----	----------------------------	-----	--------------------------------	-----	--------------------------------	-----	--------------------------	-----	---------------------------	-----	------------------------------	-----	------------------------------------	-----	------------------------------------	-----	---------------------------------------	----	-------------------------------	----	------------------------------	----	-----------------------------------	-----	----------------------------------	-----	-------------------------------------	----	-------------------------------------	----------	----------------------------------	----	--------------------------------------	-----	---------------------------------	-----	------------------------------	-----	-----------------------------	-----	------------------------------	-----	--------------------------	-----	-------------------------------	-----	-------------------------------	---	---------------------------------------	---	-------------------------------------	-----	-----------------------------------	-----	----------------------------	-----	-----------------------------------	----	---------------------------	-----	--------------------------	-----	------------------------	----------	-------------------------	-----	-----------------------	-----	--	-----	------------------------------	-----	-------------------------------	-----	----------------------------	-----	------------------------------	-----	----------------------------	-----	---------------------------	-----	--------------------------------	-----	--------------------------------	-----	-----------------------------	-----	-----------------------------	-----	--	----	---	---------------------------	-----	--------------------------------	----	---	-----	-----------------------	-----	------------------------	-----	------------------------	-----	------------------	----	---	--------------------------------------	-----	------------------------	-----	-------------------------------------	----	------------------------------	-----	-----------------------------	-----	-----------------------------------	-----	---	-----	--	-----	---------------------------------------	-----	-----------------------------	-----	-------------------------------------	-----	---	-----	-------------------------------------	-----	-----------------	-----	--------------------------------	-----	------------------------------	-----	--------------------------------	-----	----------------------------	-----	-------------------------------------	----	---------------------	-----	----------------------------	-----	---	------	-------------------	-----	------------------------	-----	--	-----	-------------------------	--------	-------------------------------	-----	------------------------------	-----	--	-----	-------------------------------	-----	------------------------------	-----	-----------------------------	-----	----------------------------------	-------	--------------------------	-----	------------------------	----	-------------------------------------	-----	-----------------------------	-------	--------------------------	-----	----------------------------	----	------------	----	--	-----	-----------------------------	-----	--	-----	-------------------------------	-----	---	-----	------------------------------	-----	---------------------------------	------	-------------------------------	-----	-----------------------------	------------	-----------------------------	-------	-----------------------------	-----	-------------------------------------	-----	-------------------------------------	-----	--------------------------------------	-----	---------------------	-----	-----------------------------------	-------	-----------------------------------	------	-------------------------------	----	--------------------------------	-------	---------------------------------	-----	--------------------------------	-----	---------------------------	-----	-----------------------------------	-----	---	-----	--	-----	--	-----	----------------------	-------	-------------------------------------	----	-----------------------	-----	----------------	-----	--	-----	------------------------------	-----	-----------------------------------	-----	--------------------------------	-----	-----------------------------------	-----	----------------------------------	-----	--	-----	--	-----

Rochester-Pean pinza hemostatica	108	Schioetz tonometro	394/2	separador abdominal Rochard	186
Roeder pinza de campo	132	Schlesinger pinza cortante para laminectomia	342	separador abdominal Us-Balfour	184
Roger elevador para el tabique nasal	437	Schmeden pinza nasal	427	separador Adams-Mayo	171
Roger pinza traumatica	127	Schmid canula para lavador vascular	338	separador Adson	172-174
Rogge pinza para esterilizacion	227	Schmidt-Moritz baja-lengua	452	separador Adson Anderson	172
Rollet cincel para extirpacion	374	Schmieden sonda conductora	221	separador Adson-Beckmann	175
Rollet gancho	375	Schmieden-Dick aguja para ligadura	219	separador Alm	168
rompe hojas Castroviejo	45	Schmieden-Payr sonda conductora	221	separador Anderson	198
rompe hojas Chris-Troutman	45	Schmieden-Taylor tijera duramadre	65/1	separador Anderson Adson	172
rompe hojas Hadeo	45	Schnidt pinza para coger las amigdalas	467	separador Aufranc-Cobra	289
rompe hojas Troutman-Chris	45	Schoenborn separador para la glandula tiroidea	479	separador Baby Roux	140
Rose separador	140	Schröder cureta uterina	595	separador Beckmann	176
Rosen cuchillo	418	Schröder pinza uterina	584	separador Beckmann-Adson	175
Rosen gancho	419	Schroeder (Pozzi) pinza uterina	582	separador Beckmann-Eaton	176
Rosen tubo de aspiracion	338	Schroeder pinza uterina	583	separador Brunner	167
Roser-Koenig abre-boca	454	Schubert pinza para biopsia	588	separador Burrows-Jackson	189/2
Ross separador	148/1	Schuhknecht cuchillo	418	separador Caspar	179
Ross separador para aorta	148/1	Schultze salpingografo	596	separador Cloward	178/1-178/4
rotador Bechert	379	Schulze-Bergmann especulo rectal	560	separador Cobra-Aufranc	289
Roux Baby separador	140	Schumacher pinza para biopsia	588, 589	separador Collin	139
Roux mini separador	140	Schumacher punta de pinza	472	separador Collin-Hartmann	141
Roux separador	139	Schumacher tijera para cordon umbilical	64	separador Collins-Mayo	141
Rowe pinza para reposicion	459	Schumacher tijera para esternon	481	separador Contour-Scalp	169
Rubin cincel nasal	440	Schweigger pinza capsular	391	separador Cooley	148
Rubin pinza para magullar tabique	428	Scoville cucharilla cortante	253	separador Coronal Blow Lift	198
Rudd ligador para hemorroides	568	Scoville separador para la raiz de nervios	329/1, 330	separador Coryllos (Thorax)	166
Rumel pinza hemostatica	117	Scoville separador para laminectomia	196	separador costal Burford-Finochietto	483
Rumel-Belmont tournique	528	Scoville-Haverfield separador para laminectomia	196	separador costal Cooley	485, 487
Rumel-DeBakey pinza para ligaduras	499	Scudder pinza intestinal	541	separador costal DeBoer	486
Ruskin pinza gubia	239	Sebileau periostotomo	275	separador costal Favalaro-Morse	484
Ruskin-Liston pinza cortante para huesos	241	Sedillo periostotomo	274, 275	separador costal Finochietto	482, 484
Ruskin-Stille pinza gubia	239	Segond bisturi para fibroma	594	separador costal Finochietto-Burford	483
Russel-Davis baja-lengua	458	Segond pinza para histerectomia	125	separador costal Finochietto-Rienhoff	486
Rydel-Seiffert diaposon	404	Segond-Landau pinza para histerectomia	125	separador costal Haight	487
Ryder porta aguja	210	Seifert punta de pinza	472	separador costal Morse	484
S		Seiffert-Rydel diaposon	404	separador costal Morse-Favaloro	484
Saalfeld saca comedones	608	Seldin periostotomo	277	separador costal Rienhoff-Finochietto	486
saca comedones Saalfeld	608	Sellheim separador obstetrico	607	separador costal Tuffier	487
saca comedones Schamberg	608	Sellers aproximador para costillas	489/1	separador Crile	140
saca comedones Unna	608	Sellers-Craford pinza hemostatica	119	separador cuello vejiga Millin	553
saca comedones Walton	608	Semb periostotomo	278	separador Cushing	151-153
Sachs elevador para duramadre	332	Semb pinza bronquial	491	separador Czerny	141
Sachs gancho para nervio	329	Semb pinza cortante para huesos	242	separador Darling	178
Saenger pinza para aborto	606	Semb pinza gubia	240	separador Davidson (Scapula)	166
salpingografo Schultze	596	Semb pinza para hueso	243	separador de mobilizacion Tessier	463/3
Sanvenero tijera para cirugia	54/1	Semb-DeBakey pinza para ligadura y la aorta	499	separador de pelvis St. Marks	165
Sarot pinza hemostatica	118	Semken pinza de diseccion	86	separador de sistema Leyla	368-368/3
Sarot porta aguja	211	Semm especulo vaginal	571	separador Deaver	145, 146
Satinsky pinza para vasos	491	Senn-Green separador	153	separador Deaver Grip	146
Satinsky tijera para vasija	65/2	Senn-Miller separador	143	separador DeBakey	189/1
Satinsky-DeBakey pinza para oclusion tangencial	502	sensimetro Wartenberg	25	separador Desmarres	151
Satterlee sierra para amputacion	296	separador abdominal Baby Balfour	182, 183	separador Doyen	163
Sauerbruch costotomo	481	separador abdominal Baby Gosset	181	separador Doyen-Stille	167
Sauerbruch pinza	240	separador abdominal Back holder	192-195	separador Eastman-Richardson	142
Sauerbruch pinza para desechos	227	separador abdominal Balfour	182, 183	separador Eaton-Beckmann	176
Sauerbruch separador	164, 166	separador abdominal Balfour Baby	182, 183	separador espinal Taylor	291
Sauerbruch-Frey costotomo	481	separador abdominal Balfour-Us	184	separador Farabeuf	139
Sawtell pinza para coger las amigdalas	467	separador abdominal Browne-Denis	185	separador Finsen	168
Sawyer especulo rectal	560	separador abdominal Charney	289	separador Freeman	198
Sayre elevador	281	separador abdominal Collin	190	separador Friedmann	477, 577
Scaglietti pinza gubia	240	separador abdominal Collin Loktite	191	separador Fritsch	163
Scalp-Contour separador	169	separador abdominal Denis-Browne	185	separador Gil-Vernet	152
Scapula (Davidson) separador	166	separador abdominal Doyen	189/1	separador Goelet	141
Schaedel pinza de campo	132	separador abdominal Frazier	181	separador Green	160
Schamberg saca comedones	608	separador abdominal Gosset	181	separador Green-Langenbeck	153
Schede cucharilla cortante	251	separador abdominal Gosset Baby	181	separador Green-Senn	153
Scheidel-Hepp micro tijera	78	separador abdominal Kirschner	185-187/1	separador Grip Deaver	146
Scheie cuchillo para goniotomia	373	separador abdominal Kümmel	143/4	separador Grip Kelly	142
Scheinmann punta de pinza	472	separador abdominal Loktite Collin	191	separador Grip Richardson	142
Scherbak especulo vaginal	575	separador abdominal O'Connor-O'Sullivan	181	separador Harrington	147
Schimmelbusch tambores para esterilizacion	622	separador abdominal O'Sullivan-O'Connor	181	separador Harrington-Pemberton	147
Schink dermatomo	49	separador abdominal Reverdin	143/3	separador Hartmann-Collin	141
		separador abdominal Ricard	191	separador Hasson	143

separador Heaney.....	164	separador para rodilla Blount.....	289	sierra nasal Joseph.....	446
separador Henley.....	170	separador para tejido cervical Cloward.....	339	sierra oscilante con aspiracion.....	231-231/1
separador Hibbs.....	164	separador para tendones Bunell.....	292	sierra oscilante para vendajes enyesados.....	230/10-230/18
separador Holzheimer.....	168	separador para uvula Love.....	465	sierra para abrir anillos Hadeo.....	297
separador Hösel.....	167	separador para yesos Beeson.....	232	sierra para abrir anillos Walton.....	297
separador intestinal Leriche.....	143/4	separador para yesos Haglund-Stille.....	232	sierra para amputacion Bier.....	296
separador intra oral.....	463/1, 463/4	separador para yesos Henning.....	232	sierra para amputacion Charriere.....	296
separador intra oral L&M.....	463/4	separador para yesos Stille-Haglund.....	232	sierra para amputacion Langenbeck.....	296
separador Israel.....	162	separador Parker.....	139	sierra para amputacion Satterlee.....	296
separador Jackson-Burrows.....	189/2	separador Parker-Langenbeck / Us Army.....	141	sierra para autopsia.....	230-230/9
separador Jansen.....	168	separador Pemberton-Harrington.....	147	sierra para vendajes enyesados Engel.....	229
separador Joll.....	477, 577	separador perineal Gelpi.....	189/1, 189/2	silleta.....	621/1
separador Kelly.....	142, 164	separador Perkins.....	168	Silver cincel nasal.....	442
separador Kelly Grip.....	142	separador Plester.....	171	Silver dermatomo.....	50
separador Kocher.....	155	separador prostatico Young.....	550	Simcoe canula.....	394/2
separador Kocher.....	159, 160, 163	separador Ragnell.....	140	Sims cureta uterina.....	594
separador Kocher-Langenbeck.....	159	separador rectal Buie-Smith.....	561	Simon separador.....	164
separador Koerte.....	162	separador rectal Smith-Buie.....	561	Simplex sierra-tubos.....	624
separador König.....	153	separador Richardson.....	142	Simpson forceps obstetrico.....	602
separador Körte.....	143/3	separador Richardson Grip.....	142	Simpson-Braun forceps obstetrico.....	602
separador Lahey.....	157	separador Richardson-Eastman.....	142	Simpson-Luikart forceps obstetrico.....	603
separador Langenbeck.....	158, 159	separador Rigby.....	189/2	Sims cureta uterina.....	597
separador Langenbeck-Green.....	153	separador Rose.....	140	Sims depresor uterino.....	586
separador Langenbeck-Kocher.....	159	separador Ross.....	148/1	Sims dilatador uterino.....	581
separador Little.....	157	separador Roux.....	139	Sims especulo rectal.....	559
separador Luer.....	140	separador Roux Baby.....	140	Sims especulo vaginal.....	573
separador mamarío Breast.....	198	separador Roux mini.....	140	Sims histerometro.....	586
separador manipular Obwegeser.....	461/1	separador sagital Smith.....	463/5	Sims tijera ginecologica.....	62
separador Martin.....	175/1	separador Sauerbruch.....	164, 166	Sims-Maier pinza porta-esponja.....	134
separador Mathieu.....	141	separador Scalp-Contour.....	169	Singley pinza de diseccion.....	88
separador Mayo-Adams.....	171	separador Scapula (Davidson).....	166	Sinsky gancho.....	376
separador Mayo-Collins.....	141	separador Senn-Green.....	153	Sinus (Lister) pinza porta esponja.....	137
separador Meyerding.....	157, 177, 180	separador Senn-Miller.....	143	Sinus sonda para sinoscopia.....	438
separador Middeldorf.....	160	separador Simon.....	164	sistema de brazo.....	188, 189
separador Mikulicz.....	163	separador Stille-Doyen.....	167	Skene pinza uterina.....	582
separador Miller-Senn.....	143	separador Stille-Strandell.....	157	Sluder-Ballenger amigdalotomo.....	470
separador Mini Roux.....	140	separador Strandell-Stille.....	157	Smellie gancho obstetrico.....	605
separador Mollison.....	171	separador Thorax (Coryllos).....	166	Smellie perforacraneo.....	607
separador Morris.....	164	separador toracico Mercedes.....	489	Smillie meniscotomo.....	292
separador Murphy.....	156	separador traqueal Bose.....	476	Smillie separador para menisco.....	291
separador nasal Converse.....	448	separador traqueal Jackson.....	476	Smith blefarostato.....	370
separador Norfolk / Norwich.....	172	separador Travers.....	172	Smith pinza.....	463
separador Norfolk / Norfolk.....	172	separador Tuffier.....	147	Smith pinza para separar la rama.....	463
separador obstetrico Sellheim.....	607	separador Us Army / Parker-Langenbeck.....	141	Smith separador sagital.....	463/5
separador Ollier.....	162	separador Vernet-Gil.....	152	Smith Us Army tijera para gaza.....	69/1
separador para aorta Ross.....	148/1	separador vesical Judd-Masson.....	552	Smith-Buie separador rectal.....	561
separador para cirugia plastica Ferriera.....	197	separador vesical Legueu.....	553	Smith-Ferris pinza cortante para laminectomia.....	343
separador para cirugia plastica Tebbetts.....	197	separador vesical Masson-Judd.....	552	Smith-Ferris pinza de diseccion.....	85
separador para cuerpo vertebral Cloward.....	339	separador vesical Millin.....	552	Smith-Heywood pinza hemorroidal.....	567
separador para cuerpo vertebral Inge.....	339	separador vesical Thomson-Walker.....	552	Smith-Kerrison-Ferris pinza sacabocado para discos intervertebral.....	344, 344/2
separador para el borde anterior Hargis.....	463	separador vesical Walker-Thomson.....	552	Smith-Petersen cincel.....	261
separador para el cuerpo mandibular Hargis.....	463/6	separador Voikmann.....	153-156	Smith-Petersen gubia.....	261
separador para el ramo Nasalis-Spina.....	461	separador Weitlaner.....	169	Smith-Petersen pinza gubia.....	238
separador para el ramo Ramus.....	461	separador Weitlaner-Wullstein.....	169	Smith-Potts pinza de diseccion.....	81, 81/2
separador para el ramo Spina-Nasalis.....	461	separador Wullstein-Weitlaner.....	169	Smith-Potts tijera vascular.....	61
separador para la glandula tiroidea Schoenborn.....	479	separador Yancoskie.....	198	Smithwick gancho para nervio.....	329
separador para la raiz de nervios D'Errico.....	329/2	separador Zenker.....	161	Smithwick pinza aplicadora.....	326
separador para la raiz de nervios Hess.....	329/1	Serpentine Grasper pinza para biopsia.....	593	Snellen asa.....	378
separador para la raiz de nervios Holsher.....	329/1	serra-fina Dieffenbach.....	104	Snellen pinza muscular.....	393
separador para la raiz de nervios Love.....	329/2, 330	serra-fina Hopkins-Johns.....	104	Socket and Ball pinza para campo.....	133
separador para la raiz de nervios Scoville.....	329/1, 330	serra-fina Johns-Hopkins.....	104	Somer pinza para el utero.....	585
separador para labios y mejillas.....	453	Seutin tijera para vendaje.....	69/2	sonda abotonada Jacobson.....	335
separador para labios y mejillas Sternberg.....	453	Sexton cuchillo auricular.....	408	sonda acanalada.....	199
separador para laminectomia Cherry.....	488	Shambaugh gancho.....	419	sonda acanalada Brodie.....	199
separador para laminectomia Haverfield-Scoville.....	196	Shapleigh asa.....	410	sonda auricular Stacke.....	199
separador para laminectomia Scoville.....	196	Shea tijera auricular micro.....	413	sonda conductora Brunner.....	221, 221/1
separador para laminectomia Scoville-Haverfield.....	196	Sheehan cincel nasal.....	441	sonda conductora Kirschner.....	221
separador para mamaría.....	486/1	Sheets canula.....	394/2	sonda conductora Koeng.....	221/1
separador para menisco Smillie.....	291	Sherman-Stille perforador de mano.....	298	sonda conductora Payr.....	221/1
separador para paladar Nager.....	465	Siebold tijera ginecologica.....	62	sonda conductora Payr-Schmieden.....	221
separador para partes blandas Obwegeser.....	460	Siegle especulo auricular.....	402	sonda conductora Hadeo.....	221/1
separador para pilar Hofer.....	465	sierra hilo Olivecrona.....	332	sonda conductora Schmieden.....	221
separador para piloro Benson.....	544				

sonda conductora Schmieden-Payr	221	Strauss pinza para el pene	553/1	tijera de diseccion Weller	53/2
sonda conductora Vienna	221/1	Struempel pinza para polipos	412	tijera de incision	52
sonda Fish	199	Strully tijera para neurocirugia	65	tijera DeBakey	60
sonda Harms	381	Struycken pinza nasal	427	tijera duramadre Schmieden-Taylor	65/1
sonda lacrimal Bowman	381	Subramanian pinza para la aorta	521	tijera duramadre Taylor-Schmieden	65/1
sonda lacrimal Worst	381	Subramanian-Miniature pinza para la aorta	521	tijera Enucleation	58
sonda metalica Walther	555	supercut tijera	71, 72	tijera face lift Freeman	73
sonda Nelaton	199	supercut tijera Baby Metzenbaum	71	tijera face lift Gorney	73
sonda para bocio Kocher	479	supercut tijera Iris	72	tijera face lift Joseph Peck	73
sonda para calculos biliares Mayo	534	supercut tijera Kilner/Ragnell	72	tijera face lift Kaye	73
sonda para fistula Lockhart-Mummery	200	supercut tijera La Grange	72	tijera face lift Peck Joseph	73
sonda para fistula Mummery-Lockhart	200	supercut tijera Lister	72	tijera face lift Rees	73
sonda para fistula Pratt	563	supercut tijera Mayo	71	tijera ginecologica Doyen	63
sonda para medir House	420	supercut tijera Mayo-Stille	71	tijera ginecologica Dubois	63
sonda para sinoscopia Sinus	438	supercut tijera Metzenbaum	71	tijera ginecologica Siebold	62
soporte de esterilizacion para alambres de Kirschner	305	supercut tijera Metzenbaum Baby	71	tijera ginecologica Sims	62
soporte de pecho Negus	459	supercut tijera Ragnell/Kilner	72	tijera ginecologica Wertheim	63
soporte pectoral Kleinsasser	36	supercut tijera Reynolds	72	tijera Martin-Cartilage	65/1
Spencer tijera para ligadura	66	supercut tijera Stevens	72	tijera nasal	428, 429
Spencer-Wells pinza hemostatica	109	supercut tijera Stille-Mayo	71	tijera nasal Cottle	59
Spinal cucharilla cortante	253	supercut tijera wagner	72	tijera nasal Fomon	58
Spina-Nasalis separador para el ramo	461	Sweet pinza aplicadora	326	tijera nasal Heymann	58
Spratt cucharilla cortante	251	Systrunk tijera para cirugia	66	tijera nasal Watson-Williams	428
Spurling pinza cortante para laminectomia	340			tijera nasal Williams-Watson	428
St. Marks separador de pelvis	165	T		tijera Northbent	66
St. Martin pinza para sutura	392	Tabb cuchillo	418	tijera para alambre y laminas Universal	67
St. Clair-Thomson cuchillo para vegetaciones adenoides	450	Takahashi pinza nasal	427	tijera para amigdalas	59
Stacke sonda auricular	199	taladros	302	tijera para amigdalas Boettcher	59
Stamm pinza cortante para huesos	241	tambores para esterilizacion Schimmelbusch	622	tijera para amigdalas Dean	59
Standard (Nelson) trocar abdominal	204	tamponeador LUnitschek	465	tijera para amigdalas Good	59
Standard estuche para sutura	226	Tarnier cranioclasto	607	tijera para capsula Pesano	53/2
Standard pinza de diseccion	81, 81/1	Tarnier forceps obstetrico	604	tijera para cartilago McIndoe	65/1
Standard tijera para cirugia	51	tarros	620	tijera para cirugia Cottle	56
Staude-Moore pinza uterina	582	Taylor martillo de percusion	24	tijera para cirugia Graeffe	56
Steinmann alambre	307, 308	Taylor pinza de diseccion	87	tijera para cirugia Iris	54/2
Steinmann pinza de agarre para tendones	292	Taylor separador espinal	291	tijera para cirugia Joseph	54/1
Stellbrink pinza gubia	234	Taylor-Cushing pinza de diseccion	87	tijera para cirugia Kilner	54/1
Sternberg separador para labios y mejillas	453	Taylor-Schmieden tijera duramadre	65/1	tijera para cirugia Knapp	55
Stevens gancho para cristalino	375	Teale pinza uterina	583	tijera para cirugia Littler	55
Stevens pinza para iris	383	Tebbetts separador para cirugia plastica	197	tijera para cirugia Metzenbaum	54
Stevens porta aguja	214	tensor de cierra-hilo Demel	315	tijera para cirugia Reynolds	54/1
Stevens tijera para tenotomia	58	tensor de cierra-hilo Loute	315	tijera para cirugia Sanvenero	54/1
Stevens tijera supercut	72	tensor de taladros	313	tijera para cirugia Standard	51
Stevenson blearostato	371	Terson pinza capsular	391	tijera para cirugia Systrunk	66
Stieglitz pinza para espinas	92	Tessier separador de mobilizacion	463/3	tijera para cirugia Waldmann	64
Stille (Leksell) pinza gubia	240	Thierry forceps obstetricos	603	tijera para cordon umbilical Busch	64
Stille cincel	260	Thomas cureta uterina	599	tijera para cordon umbilical Mod. USA	64
Stille cizalla para yesos	229	Thomas-Gaylor pinza para biopsia	588	tijera para cordon umbilical Schuhmacher	64
Stille costotomo	480	Thomas-Price pinza bronquial	490	tijera para cordon umbilical USA Mod.	64
Stille gubia	260	Thoms-Allis pinza intestinal	538	tijera para corneales Castroviejo	79
Stille osteotomo	260	Thomson-St. Clair cuchillo para vegetaciones adenoides	450	tijera para encias Fox-Goldman	67
Stille perforador de mano	298	Thomson-Walker separador vesical	552	tijera para encias Goldman-Fox	67
Stille pinza de diseccion	81, 81/1	Thorax (Coryllos) separador	166	tijera para encias LaGrange	69
Stille pinza hemostatica	122	Thorek tijera vesicula biliar	65/2	tijera para encias Locklin	69
Stille-Barraya pinza de diseccion	88	Thudichum especulo nasal	421	tijera para encias Quinby	67
Stille-Giertz costotomo	481	Tieck-Halle especulo nasal	423	tijera para enterotomo	66
Stille-Haglund separador para yesos	232	tijera Adson-Toennis	65	tijera para episiotomia Braun-Stadler	64
Stille-Horsley pinza cortante para huesos	242	tijera auricular micro Bellucci	413, 417	tijera para episiotomia Stadler-Braun	64
Stille-Liston pinza cortante para huesos	242	tijera auricular micro Shea	413	tijera para esternon Schumacher	481
Stille-Luer pinza gubia	239	tijera Cartilage-Martin	65/1	tijera para gaza Smith Us Army	69/1
Stille-Mayo tijera de diseccion	52/1	tijera corneal Aebli	58	tijera para gaza US Army Smith	69/1
Stille-Mayo tijera supercut	71	tijera cuticular	610	tijera para intestino Fergusson	66
Stille-Ruskin pinza gubia	239	tijera de diseccion Baby Lexer	53	tijera para iridectomia Castroviejo	79
Stille-Sherman perforador de mano	298	tijera de diseccion Deaver	52	tijera para iridectomia Vannas	79
Stille-Strandell separador	157	tijera de diseccion Jorgensen	53	tijera para iris Noyes	75
Stockmann pinza para el pene	553/1	tijera de diseccion Lexer	53	tijera para iris Wecker	75
Stone pinza para cerrar clamps	545	tijera de diseccion Lexer Baby	53	tijera para ligadura Heath	66
Stone-Watt manguito de cierre	545	tijera de diseccion Mayo	52/1	tijera para ligadura Littauer	66
Stone-Watt pinza intestinal	545	tijera de diseccion Mayo-Noble	52/1	tijera para ligadura Spencer	66
Strabismus tijera	58	tijera de diseccion Mayo-Stille	52/1	tijera para ligaduras Wavecut	54
Strandell-Stille separador	157	tijera de diseccion Metzenbaum	53/1	tijera para neurocirugia	65
Strassburger pinza de diseccion	89	tijera de diseccion Noble-Mayo	52/1	tijera para neurocirugia Strully	65
Stratte porta aguja	212	tijera de diseccion Stille-Mayo	52/1	tijera para oftalmologia	57, 75, 79

tijera para oftalmologia Barraquer Colibri.....	75	Townsend-Down-Mini pinza para biopsia.....	591	uretrotomo Otis	553
tijera para oftalmologia Colibri Barraquer.....	75	Townsend-Up-Mini pinza para biopsia.....	591	Us Army / Parker-Langenbeck separador.....	141
tijera para oftalmologia Gradle.....	57	Toybee especulo auricular.....	399	Us Army Smith tijera para gaza.....	69/1
tijera para parametrium.....	63	tractor Barton.....	603/2	USA Mod. tijera para cordon umbilical.....	64
tijera para preparacion.....	65	tractor Bill.....	604	USA pinza de diseccion.....	81, 81/1
tijera para rinoplastia Fomon.....	65/1	tractor Bill-Luikart.....	604		
tijera para septo Killian.....	471	tractor Luikart-Bill.....	604	V	
tijera para tendon Westcott.....	75	transformador para mango de pila para laringoscopio.....	34	V. Petz aparato para suturar estomago y intestinos.....	549
tijera para tenotomia Stevens.....	58	Travers separador.....	172	vaina para tornillos.....	324
tijera para uñas.....	609, 614	trefina para aorta.....	528	Valleix histerometro.....	586
tijera para vasija Klinkenbergh-Loth.....	65/2	Trelat especulo vaginal.....	571	Van Buren bujia dilatadora.....	554
tijera para vasija Loth-Klinkenbergh.....	65/2	trepano Keyes.....	608	Van Buren pinza para secuestros.....	249
tijera para vendaje.....	69/1, 69/2, 70	Trethowan Lane elevador.....	290	Van Doren pinza para biopsia.....	588
tijera para vendaje Bergmann.....	69/1	trocar abdominal Nelson (Standard).....	204	Vannas tijera para iridectomia.....	79
tijera para vendaje Bruns.....	70	trocar abdominal Standard (Nelson).....	204	Varady instrumento para varices.....	202
tijera para vendaje Esmarch.....	69/2	trocar Douglas.....	204	vasos graduados.....	621
tijera para vendaje Excenter Hadeo.....	69/2	trocar Nelson.....	205	vendaje de compresion Esmarch.....	296
tijera para vendaje Knowles.....	70	trocar Ochsner.....	205	Verbrugge pinza para hueso.....	245
tijera para vendaje Lister.....	69/1	trocar para seno maxilar Coakley.....	204	Verbrugge-Müller elevador.....	286/2
tijera para vendaje Lorenz.....	70	trocar para seno maxilar Lichtwitz.....	204	Vernet-Gil separador.....	152
tijera para vendaje Hadeo Excenter.....	69/2	trocar para seno maxilar Pierce.....	204	Verres aguja para neumoperitoneo.....	206
tijera para vendaje Seutin.....	69/2	trocar Universal.....	204	Vienna especulo nasal.....	421
tijera para vendaje Universal.....	70	Troeltsch (Wilde) pinza auricular.....	410	Vienna Mod. especulo nasal.....	421
tijera para vesicula biliar Thorek.....	65/2	Troeltsch pinza nasal.....	424	Vienna sonda conductora.....	221/1
tijera pulmonares Crafoord.....	65/2	Troemner martillo de percusion.....	24	Virchow cuchillo para autopsia.....	48
tijera Strabismus.....	58	Trousseau-Baby dilatador traqueal.....	476	Virchow cuchillo para cerebro.....	48
tijera supercut.....	71, 72	Troutman (Colibr) pinza para iris.....	384	Volkman cucharilla cortante.....	251, 257
tijera supercut Baby Metzenbaum.....	71	Troutman pinza para iris.....	389	Volkman separador.....	153-156
tijera supercut Iris.....	72	Tübingen Mod. pinza para ligadura.....	392	Voltolini especulo nasal.....	421
tijera supercut Kilner/Ragnell.....	72	Tübingen Mod. pinza para sutura.....	386	Voss-Krause polipotomo.....	433/2
tijera supercut La Grange.....	72	Tübingen pinza para ligadura.....	392	Vu-More especulo vaginal.....	569
tijera supercut Lister.....	72	Tübingen pinza para sutura.....	386		
tijera supercut Mayo.....	71	tubo de aspiracion.....	27, 28, 337, 337/2, 338	W	
tijera supercut Mayo-Stille.....	71	tubo de aspiracion Adson.....	337	Wachenfeldt pinza para aplicar agrafes.....	224
tijera supercut Metzenbaum.....	71	tubo de aspiracion Andrew-Pyncheon.....	28	Wadsworth-Todd cauterio.....	378
tijera supercut Ragnell/Kilner.....	72	tubo de aspiracion Baby-Yankauer.....	27	Wagener gancho abotonado.....	409
tijera supercut Reynolds.....	72	tubo de aspiracion Fergusson.....	337	Wagener-Mosher canula para traqueotomia.....	477
tijera supercut Stevens.....	72	tubo de aspiracion Fergusson/Frazier.....	337	Wagner pinza cortante para laminectomia.....	343
tijera supercut Stille-Mayo.....	71	tubo de aspiracion Frazier/Fergusson.....	337	Wagner tijera.....	67
tijera supercut Wagner.....	72	tubo de aspiracion House.....	337/2	Wagner tijera supercut.....	72
tijera Toennis-Adson.....	65	tubo de aspiracion Plester.....	338	Waldmann tijera para cirugía.....	64
tijera vascular.....	59-61	tubo de aspiracion Poole.....	27	Walker-Thomson separador vesical.....	552
tijera vascular DeBakey.....	61	tubo de aspiracion Pyncheon-Andrew.....	28	Wallich cucharilla para aborto.....	607
tijera vascular DeMartel-Potts.....	59	tubo de aspiracion Rosen.....	338	Walsham pinza para enderezar el tabique nasal.....	449
tijera vascular Dietrich.....	60	tubo de aspiracion Yankauer.....	27	Walther cateter.....	555
tijera vascular Favalaro.....	61	tubo de aspiracion Yankauer-Baby.....	27	Walther sonda metalica.....	555
tijera vascular Kelly.....	61	tubo de aspiracion Yankauer-Baby.....	27	Walton gubia para cuerpos extraños.....	374
tijera vascular Potts-DeMartel.....	59	tubo de aspiracion Yasargil.....	337/1	Walton saca comedones.....	608
tijera vascular Potts-Smith.....	61	tubo de extension Bruenings.....	472	Walton sierra para abrir anillos.....	297
tijera vascular Smith-Potts.....	61	Tucker-Luikart-McLean forceps obstetrico.....	603/1	Wangensteen pinza de diseccion.....	89
tijera vasija Satinsky.....	65/2	Tuffier pinza hemostatica.....	110	Wangensteen porta aguja.....	210
tijera Wagner.....	67	Tuffier separador.....	147	Wartenberg sensorio.....	25
Tilley pinza auricular.....	411	Tuffier separador costal.....	487	Watson dermatomo.....	50
tirabuzon para fibroma Doyen.....	594	Tumbull alicata para cortar uñas.....	609	Watson-Cheyne disecador.....	199
Tischler-Down pinza para biopsia.....	591	Turrel pinza para biopsia rectal.....	567	Watson-Cheyne elevador.....	283
Tischler-Kevorkian pinza para biopsia.....	592	Tyding amigdalotomo.....	469	Watson-Williams pinza nasal.....	428
Tischler-Morgan pinza para biopsia.....	590, 591	Tyding pinza para coger amigdalas.....	468	Watt-Stone manguito de cierre.....	545
Tischler-Up pinza para biopsia.....	591			Watt-Stone pinza intestinal.....	545
Tobold baja-lengua.....	453	U		Waugh pinza de diseccion.....	83
Tobold porta-algodon.....	203	U.S. Kirschner estribo para extension.....	312	Wavecut tijera para ligaduras.....	54
Todd-Wadsworth cauterio.....	378	Uckermann porta-algodon.....	203	Weber asa.....	378
Toennis elevador para duramadre.....	332	Ulrich pinza para hueso.....	248	Weber pinza para la aorta.....	501
Toennis pinza hemostatica.....	117	Ulrich pinza para tapones.....	135	Webster porta aguja.....	208
Toennis-Adson tijera.....	65	Uni I estuche de diagnostico / otoscopio.....	13	Wecker espátula para iris.....	378
Toennis-Olivecrona pinza aplicadora.....	326	Uni II estuche de diagnostico/ oftalmoscopio May.....	14	Wecker tijera para iris.....	75
Tohoku pinza de campo.....	132	Uni III estuche de diagnostico.....	15	Week blefarostato.....	370
tonometro Schioetz.....	394/2	Universal pinza para esterilizacion.....	227	Weil-Blakesley pinza nasal.....	426
Took cuchillo corneal.....	373	Universal tijera para alambre y laminas.....	67	Weiss-Dupuy aguja para sutura amigdalas.....	466
torniquete pneumatico.....	295	Universal tijera para vendaje.....	70	Weitlaner separador.....	169
tournique Belmont-Rumel.....	528	Universal trocar.....	204	Weitlaner-Wullstein separador.....	169
tournique Rumel-Belmont.....	528	Unna saca comedones.....	608	Weller tijera de diseccion.....	53/2
Townley calibre.....	26	Up-Mini-Townsend pinza para biopsia.....	591	Wells espátula para enucleacion.....	378
Townsend pinza para biopsia.....	591	Up-Tischler pinza para biopsia.....	591	Wells-Spencer pinza hemostatica.....	109

Wertheim pinza para histerectomia.....	124, 128	Zielke gubia.....	264
Wertheim tijera ginecologica.....	63		
Wertheim-Cullen pinza para histerectomia.....	125		
West cincel nasal.....	442/1		
Westcott tijera para tendon.....	75		
Westmacott pinza nasal.....	424		
Wheeler cuchillo para discision.....	373		
Wheeler espátula para ciclodialis.....	379		
White pinza para coger amigdalas.....	467		
Wieder baja-lengua.....	452		
Wiener escofina nasal.....	443		
Wiener gancho para iris.....	375		
Wigmore cuchillo para vendajes enyesados.....	229		
Wikstroem pinza hemostatica.....	117		
Wilde (Troeltsch) pinza auricular.....	410		
Wilde cierra-nudo auricular.....	411		
Wilde polipotomo.....	433/2		
Wilder asa.....	378		
Wilder dilatador lacrimal.....	381		
Williams destornillador.....	323		
Willet Martel pinza hemostatica.....	110		
Williams blefarostato.....	370		
Williams pinza para tejido.....	539		
Williams-Watson pinza nasal.....	428		
Williger cucharilla cortante.....	255, 257		
Williger martillo.....	271		
Williger periostotomo.....	276		
Winter pinza para aborto.....	606		
Wittner pinza para biopsia.....	589		
Wolff pinza para arrancar vendaje enyesado.....	233		
Wolfson-DeMartel pinza para anastomosis.....	546		
Wolfson-DeMartel pinza para cerrar clamps.....	546		
Wolfson-DeMartel porta-clamps.....	546		
Wood-Crile porta aguja.....	209		
Woodson elevador para duramadre.....	333		
Worst sonda lacrimal.....	381		
Wrigley forceps obstetrico.....	602		
Wulstein cuchillo.....	418		
Wulstein mango de aspiracion.....	338		
Wulstein pinza auricular micro.....	416		
Wulstein separador.....	171		
Wulstein-Hartmann pinza para polipos.....	412		
Wulstein-Weitlaner separador.....	169		
Wylie dilatador uterino.....	581		
Wylie pinza para la aorta.....	501/1, 501/2		
Y			
Yankoskie separador.....	198		
Yankauer elevador para amigdalas.....	465		
Yankauer tubo de aspiracion.....	27		
Yankauer-Baby tubo de aspiracion.....	27		
Yasargil clips para aneurisma.....	345-356		
Yasargil gancho para galea.....	330		
Yasargil pinza para tumores.....	97		
Yasargil tubo de aspiracion.....	337/1		
Yeoman cierra-nudo rectal.....	566		
Yeoman pinza para biopsia rectal.....	566, 567		
Young Boomerang aguja.....	220		
Young Boomerang porta aguja.....	220		
Young pinza de agarre para prostata.....	550		
Young pinza tira-lengua.....	453		
Young separador prostatico.....	550		
Z			
Zaufal elevador auricular.....	409		
Zaufal-Jansen elevador auricular.....	409		
Zaufal-Jansen pinza gubia.....	238		
Zenker pinza hemostatica.....	118		
Zenker separador.....	161		
Ziegler blefarostato.....	371		
Ziegler cuchillo para discision.....	373		
Ziegler cuchillo para iris.....	372		
Ziegler dilatador lacrimal.....	381		



ADENOTOMO LA FORCE.....	450	AGO, KOENIG.....	223	AXENFELD CURETTA DA CALAZIO.....	377
AGRAFES, MICHEL.....	224	AGO, REVERDIN.....	220	AYER PINZA PER CALAZIO.....	393
ABBASSALINGUA.....	451	AGO, ROSEN.....	419	B	
ABBASSALINGUA DAVIS-BOYLE.....	455	AGO, YOUNG-BOOMERANG.....	220	BABCOCK PINZA PER AFFERRARE INTESTINI.....	539
ABBASSALINGUA DOUGHTY.....	458	ALAN-PARKS DIVARICATORE ANALE.....	561	BABINSKI MARTELLO DA PERCUSSIONE.....	24
ABBASSALINGUA RUSSEL-DAVIS.....	458	ALDERDYCE ELEVATORE.....	282	BABY BURKE PINZA PER BIOPSIA.....	590
ABBASSALINGUA, ANDREW.....	452	ALESATORE PER FEMORE, KUENTSCHER.....	321	BABY GOSSET DIVARICATORE ADDOMINALE.....	181
ABBASSALINGUA, BRUENINGS.....	451	ALESATORE PER L'APERTURA DEL MIDOLLO, KUENTSCHER.....	321	BABY METZENBAUM SUPERCUT FORBICI.....	71
ABBASSALINGUA, BUCHWALD.....	451	ALEXANDER PERIOSTOTOMO.....	276	BABY TISCHLER PINZA PER BIOPSIA.....	592
ABBASSALINGUA, DINGMANN.....	456	ALEXANDER PINZA PER BIOPSIA.....	589	BABY WEBSTER PORT'AGHI.....	208
ABBASSALINGUA, FRENZEL.....	451	ALEXANDER SCALPELLO.....	259	BABY YANKAUER CANNULA D'ASPIRAZIONE.....	27
ABBASSALINGUA, HARTMANN.....	452	ALEXANDER SGORBIA.....	259	BABY-KOCHER PINZA PER BIOPSIA.....	540
ABBASSALINGUA, KILNER-DOUGHTY.....	456	ALGESIMETRO, WARTENBERG.....	25	BABY-OLSEN-HEGAR PORT'AGHI.....	212
ABBASSALINGUA, KROENIG.....	451	ALLEN PINZA PER L'APPENDICE.....	544	BABYPHON SFGIMOMANOMTERO.....	10
ABBASSALINGUA, MAYO.....	451	ALLIS PINZA PER AFFERRARE INTESTINI.....	537	BACINELLA.....	619, 620
ABBASSALINGUA, MORITZ-SCHMIDT.....	452	ALLIS-ADAIR PINZA PER AFFERRARE INTESTINI.....	537	BACINELLA PER PLACENTA.....	621
ABBASSALINGUA, TOBOLD.....	453	ALLIS-BABY PINZA PER AFFERARE INTESTINI.....	537	BACINELLA RENIFORMA.....	619
ABBASSALINGUA, WIEDER.....	452	ALLISON SPATOLA PER POLMONE.....	489	BACINELLA TISSUTALE.....	132
ABRAHAM COLTELLO PER TONSILLE.....	466	ALM DIVARICATORE.....	168	BAILEY APPROSSIMATORE COSTALE.....	489
ABRAHAM PINZA PER TONSILLE.....	468	ALVIS CURETTA PER CORPI ESTRANEI.....	374	BAILEY-BABY APPROSSIMATORE COSTALE.....	489
ACCESSORI DI FISSAZIONE, ANELLI E BARRE.....	195	AMNIOSCOPO.....	601	BAILEY-GIBBON APPROSSIMATORE COSTALE.....	489
ACCESSORI PER SEGA PER AUTOPSIA.....	231/2, 231/3	AMNIOTOMO, BEACHAM.....	586	BAINBRIDGE PINZA EMOSTATICA.....	119/2
ADATTATORE DI ILLUMINAZIONE.....	601	ANDERSON ADSON DIVARICATORE.....	172	BAINBRIDGE PINZA VASCOLARE.....	495
ADLERKREUTZ PINZA VASCOLARE.....	84	ANDREW ABBASSALINGUA.....	452	BAKES DILATATORE BILIARE.....	532
ADSON DIVARICATORE.....	173	ANDREW-PYNCHON TUBO D'ASPIRAZIONE.....	28	BALFOUR BABY DIVARICATORE ADDOMINALE.....	182
ADSON PINZA ANATOMICA.....	82	ANELLI DI GOMMA PER LEGATURA.....	568	BALFOUR DIVARICATORE ADDOMINALE.....	182
ADSON PINZA ANATOMICA.....	82	ANOSCOPO, HIRSCHMANN.....	562	BALFOUR DIVARICATORE ADDOMINALE.....	183
ADSON PINZA CHIRURGICA.....	82	ANSA AURICOLARE, BILLEAU.....	409	BALFOUR-US DIVARICATORE ADDOMINALE.....	184
ADSON BABY PINZA EMOSTATICA.....	113	ANSA AURICOLARE, SHAPLEIGH.....	410	BALL AND SOCKET PINZA FISSATELI.....	133
ADSON DIVARICATORE.....	172	ANSA PER CATERATTA, ARLT.....	378	BALLENGER COLTELLO PER SETTO.....	436
ADSON MICRO PINZA ANATOMICA.....	82	ANSA PER CATERATTA, SNELLEN.....	378	BALLENGER ELEVATORE PER SETTO.....	439
ADSON MICRO PINZA CHIRURGICA.....	82	ANSA PER CATERATTA, WEBER.....	378	BALLENGER PINZA PER TONSILLE.....	467
ADSON PERIOSTOTOMO.....	282	ANSA PER CATERATTA, WILDER.....	378	BANE-HARTMANN PINZA SGORBIA.....	237
ADSON PINZA EMOSTATICA.....	112	ANSA PER POLIPI.....	411	BANGERTER SPATOLA PER CICLODIALISI.....	379
ADSON PINZA PER IPOFISI.....	334	ANSE PER TONSILLE.....	468	BARACANI INSERTO.....	472
ADSON PINZA SGORBIA.....	236	ANTRUM-CURETTA.....	435	BARANY ASSORDITORE.....	405
ADSON PORT'AGHI.....	211	ANVIL TRONCHESINA PER UNGHIE.....	613	BARBARA AGO.....	419
ADSON TENAGLIA PER OSSA.....	298	APPARECCHIATURA DI SUTURA GASTRO-INTESTINALE, V.PETZ.....	549	BARBARA UNCINO.....	419
ADSON TUBO D'ASPIRAZIONE.....	337	APPROSSIMATORE COSTALE, BAILEY.....	489	BARKAN COLTELLO PER GONIOTOMIA.....	373
ADSON UNCINO PER DURAMADRE.....	329	APPROSSIMATORE COSTALE, BAILEY-BABY.....	489	BARNHILL COLTELLO ADENOIDE.....	450
ADSON, DIVARICATORE.....	174	APPROSSIMATORE COSTALE, BAILEY-GIBBON.....	489	BARNHILL COLTELLO ADENOIDE.....	450
ADSON-BROWN PINZA CHIRURGICA.....	82	APPROSSIMATORE, BIEMER.....	366	BARON CANNULA D'ASPIRAZIONE.....	336
ADSON-BROWN PINZA CHIRURGICA.....	82	APPROSSIMATORE, BIEMER-MÜLLER.....	363	BARR SPECOLO RETTALE.....	559
AEBLI FORBICI PER OFTALMOLOGIA.....	58	APRIBOCCA DI LEGNO MAUNDER.....	459	BARRAQUER (COLIBRI) PINZA PER IRIDE.....	384
AGHI PER SUTURE.....	222, 223	APRIBOCCA, DAVIS-BOYLE.....	455	BARRAQUER BLEFAROSTATO.....	370
AGO PER BIOPSIA, FRANKLIN-SILVER.....	206	APRIBOCCA, DAVIS-MEYER.....	457	BARRAQUER COLTELLO PER CHERATOPLASTICA.....	373
AGO DI GUIDA, IOWA.....	206	APRIBOCCA, DENHART,12CM.....	454	BARRAQUER COLTELLO PER CHERATOPLASTICA.....	373
AGO DI GUIDA, REDON.....	207	APRIBOCCA, DINGMANN.....	456	BARRAQUER FORBICI OCULISTICHE.....	75
AGO DI INTRODUZIONE, OBWEGESER.....	463	APRIBOCCA, HEISTER.....	454	BARRAQUER PINZA DA FISSAZIONE.....	390
AGO DI INTRODUZIONE, OBWEGESER.....	463/3	APRIBOCCA, JENNINGS.....	454	BARRAQUER PINZA DEPILETORIA.....	395
AGO PASSAFILI, DEMEL.....	315	APRIBOCCA, KILNER-DOUGHTY.....	456	BARRAQUER PORT'AGHI.....	216, 217
AGO PER CORPI ESTRANEI.....	374	APRIBOCCA, MCIVOR.....	457	BARRAQUER-KATZIN PINZA PER IRIDE.....	384
AGO PER CORPI ESTRANEI, DAVIS.....	374	APRIBOCCA, ROSEK-KOENIG 16CM.....	454	BARRAQUER-KATZIN PINZA PER IRIDE.....	384
AGO PER CORPI ESTRANEI, FRANCIS.....	374	APRIBOCCA, DOYEN-JANSEN(MOLT).....	454	BARRAQUER-TROUTMAN PORT'AGHI.....	216
AGO PER CORPI ESTRANEI, LA FORCE.....	374	ARCOHER PINZA PER SCHEGGE.....	92	BARRET PINZA PER ABBASSARE IL COLLO DELL'UTERO.....	582
AGO PER CORPI ESTRANEI, LEVINSON.....	374	ARCO PER ESTENSIONE, BOEHLER.....	312	BARTON FORCIPE.....	603
AGO PER DISCISIONE.....	374	ARCO PER ESTENSIONE, KIRSCHNER.....	312	BARTON TRATTORE.....	603
AGO PER DISCISIONE, BOWMAN.....	374	ARCO PER ESTENSIONE, KIRSCHNER US.....	312	BAUMGARTNER PORT'AGHI.....	208
AGO PER INSUFFLAZIONE, VERESS.....	206	ARLT ANSA PER CATERATTA.....	378	BEACHAM AMNIOTOMO.....	586
AGO PER LEGATURE.....	218	ARRUGA BLEFAROSTATO.....	370	BECHERT ROTATORE PER NUCLEO.....	379
AGO PER LEGATURE SCHMIEDEN-DICK.....	219	ARRUGA CUCCHIAIO PER ASPORTAZIONE RETINALE.....	378	BECK PINZA PER ANASTOMOSI.....	520
AGO PER LEGATURE, COOPER.....	219	ARRUGA PINZA CAPSULARE.....	391	BECK PINZA VASCOLARI.....	516
AGO PER LEGATURE, DESCHAMPS.....	218	ARRUGA PORT'AGHI.....	214	BECKER CISTOTOMO.....	375
AGO PER LEGATURE, KRONECKER.....	219	ARRUGA UNCINO ESTRATTORE.....	375	BECKMANN COLTELLO ADENOIDE.....	450
AGO PER LEGATURE, NELSON.....	219	ASCH PINZA PER LA PLASTICA NASALE.....	449	BECKMANN DIVARICATORE.....	176
AGO PER PARACENTESI, LUCAE.....	408	ASSORDITORE, BARANY.....	405	BECKMANN-ADSON DIVARICATORE.....	175
AGO PER PARACENTESI, POLITZER.....	408	AUFFRANC-COBRA DIVARICATORE.....	289	BECKMANN-EATON DIVARICATORE.....	176
AGO PER TONSILLE.....	470	AUFFRICHT RASPA NASALE.....	443	BEEBEE FORBICI PER CORONA.....	68
AGO PER TONSILLE, CLAUSS.....	466	AUFFRICHT UNCINO NASALE.....	447	BEER PINZA DEPILETORIA.....	395
AGO PER TONSILLE, DUPUY-WEISS.....	466	AUVARD SPECOLO VAGINALE.....	576	BEESON DIVARICATORE PER GESSI.....	232
AGO PER TONSILLE, NAGER.....	466			BEESON DIVARICATORE PER GESSI.....	232
AGO POST MORTEM.....	268			BELLUCCI MICRO FORBICI AURICOLARI.....	413
AGO, BARBARA.....	419			BELLUCCI MICRO FORBICINE.....	417
AGO, KEITH.....	223			BENDA PER COMPRESSIONE ESMARCH.....	297

BENDER MODELLATORE PER CHIODI.....	322	BOYNTON PORT'AGHI.....	214	CANNULA D'ASPIRAZIONE PER BIOPSIA, BUIE.....	566
BENGOLEA PINZA EMOSTATICA.....	112	BOZEMANN PINZA PER TAMPONI.....	138	CANNULA D'ASPIRAZIONE POOLE.....	27
BENNETT ELEVATORE PER OSSA.....	283	BOZEMANN PORT'AGHI.....	211	CANNULA D'ASPIRAZIONE ZÖLLNER.....	337/1
BENSAUDE PROCTOSCOPO.....	565	BOZEMANN-DOUGLAS PINZA PER TAMPONI.....	138	CANNULA D'ASPIRAZIONE, ADSON.....	337
BENSON DIVARICATORE PER PILORO.....	544	BRACCIALE.....	295	CANNULA D'ASPIRAZIONE, ANDREW-PYNCHON.....	28
BERENS CHERATOMO.....	372	BRACCIO PORTALARINGOSCOPIO KLEINSASSER.....	36	CANNULA D'ASPIRAZIONE, BABY-YANKAUER.....	27
BERGMANN FORBICI PER BENDAGGI.....	69/1	BRAND ENUCLEATORE PER TENDINI.....	294	CANNULA D'ASPIRAZIONE, COOLEY.....	28
BERGMANN MARTELLO.....	272	BRAND STRUMENTI PER AFFERRARE TENDINI.....	293	CANNULA D'ASPIRAZIONE, DE BAKELY.....	28
BERKE PINZA MUSCOLARE.....	389	BRAUN CRANIOCLASTO.....	607	CANNULA D'ASPIRAZIONE, FERGUSSON.....	337
BERLINER MARTELLO DA PERCUSSIONE.....	24	BRAUN DEPRESSORE UTERINO.....	586	CANNULA D'ASPIRAZIONE, FRAZIER/FERGUSSON.....	337
BERNHARD PINZA FISSATELI.....	133	BRAUN PINZA PER ABBASSARE IL COLLO		CANNULA D'ASPIRAZIONE, PLESTER.....	338
BERRY PINZA TORCIFILO.....	319	DELL'UTERO.....	582	CANNULA D'ASPIRAZIONE, ROSEN.....	338
BETHUNE COSTOTOMO.....	481	BRAUN UNCINO SPEZZATORE.....	607	CANNULA D'ASPIRAZIONE, YASARGIL.....	337/1
BICCHIERE GRADUATO.....	620	BRAUN-STADLER FORBICI PER EPISIOTOMIA.....	64	CANNULA D'ASPIRAZIONE, HOUSE.....	337/2
BICCHIERE PER MEDICINALI.....	621	BREAST DIVARICATORE PER CHIRURGIA PLASTICA.....	198	CANNULA LARINGEA.....	470
BIEMER APPROSSIMATORE.....	366	BREISKY SPECOLO VAGINALE.....	577	CANNULA OCULISTICA JENSEN.....	394
BIEMER CLIPS PER VASI.....	361	BRIDGE PINZA EMOSTATICA.....	116	CANNULA OCULISTICA MCINTYRE.....	394
BIEMER PINZA POSA CLIPS.....	361,363,364,366	BRISTOW ELEVATORE PER OSSA.....	290	CANNULA OCULISTICA PER IRRIGAZIONE ED	
BIEMER-MÜLLER APPROSSIMATOR.....	363	BRODIE SPECILLO.....	199	ASPIRAZIONE BISHOP-HARMON.....	394/1
BIER SEGA PER AMPUTAZIONE.....	296	BROPHY PINZA ANATOMICA.....	84	CANNULA OCULISTICA, LACRIMAL.....	394
BILL TRATTORE.....	604	BROPHY PINZA CHIRURGICA.....	84	CANNULA PER ASPIRAZIONE GUILLEN.....	433/1
BILLEAU ANSA AURICOLARE.....	409	BROWN PINZA PER TESSUTI.....	83	CANNULA PER BIOPSIA, MENGHINI.....	206
BIRCHER-GANSKE TENAGLIA PER OSSA.....	246	BROWN PORT'AGHI.....	209	CANNULA PER IRRIGAZIONE KILLIAN.....	433, 433/1
BIRKETT PINZA EMOSTATICA.....	116	BRUENINGS COLTELLO PER TONSILLE.....	466	CANNULA PER IRRIGAZIONE SHEETS.....	394/2
BISHOP-HARMAN PINZA PER IRIDE.....	386	BRUENINGS ABBASSALINGUA.....	451	CANNULA PER IRRIGAZIONE, HARTMANN.....	433
BISHOP-HARMON CANNULA OCULISTICA PER		BRUENINGS INSERTO.....	472	CANNULA PER IRRIGAZIONE, SCHMID.....	338
IRRIGAZIONE ED ASPIRAZIONE.....	394/1	BRUENINGS PINZA PER SETTO NASALE.....	425	CANNULA PER IRRIGAZIONE, SIEBENMANN.....	433
BISTURI MONOUSO, STERILI.....	43	BRUENINGS SPECOLO AURICOLARE.....	401	CANNULA PER IRRIGAZIONE, SIMCOE.....	394
BISTURI PER FIBROMI, SEGOND.....	594	BRUNETTI SCALPELLO.....	268	CANNULA TRACHEALE, LUER.....	479
BISTURI, MANICO DI METALLO.....	46	BRÜNNINGS-LUCAS SCALPELLO.....	260	CANNULA TRACHEALE, WAGENER-MOSHER.....	477
BLAKE CURETTA UTERINA.....	595	BRÜNNINGS-LUCAS SCALPELLO.....	260	CANNULA TRACHEALE, CHEVALIER-JACK.....	479
BLAKE PINZA PER CALCOLI BILIARI.....	531	BRÜNNINGS-LUCAS SGORBIA.....	260	CANNULA, LICHTWITZ.....	433
BLEFAROSTATO CLARK.....	370	BRUNNER COSTOTOMO.....	481	CAPLAN PINZA NASALE.....	428
BLEFAROSTATO LIEBERMANN.....	371	BRUNNER DIVARICATORE.....	167	CARMALT PINZA PER SCHEGGE.....	91
BLEFAROSTATO, ARRUGA.....	370	BRUNNER PINZA INTESTINALE.....	543	CAROLL PINZA PER AFFERRARE TENDINI.....	293
BLEFAROSTATO, BARRAQUER.....	370	BRUNNER SONDE CONDUITRICE.....	221	CARPENTER COLTELLO PER TONSILLE.....	465
BLEFAROSTATO, BOWMAN.....	370	BRUNNER SONDE CONDUITRICE.....	221	CASPAR DIVARICATORE PER SPINA CERVICALE.....	179
BLEFAROSTATO, CASTROVIEJO.....	371	BRUNS CURETTA TAGLIENTE.....	251, 254	CASPAR DIVARICATORE PER SPINA CERVICALE.....	180
BLEFAROSTATO, CRITCHETT.....	370	BRUNS FORBICI PER BENDAGGI.....	70	CASPAR PISTONI.....	258
BLEFAROSTATO, GRAEFE.....	370	BRYANT PINZA PER MEDICATURA.....	137	CASTANEDA NEONATAL PINZA VASCOLARE.....	527
BLEFAROSTATO, LANCASTER.....	371	BUCHWALD ABBASSALINGUA.....	451	CASTROVIEJO BLEFAROSTATO.....	371
BLEFAROSTATO, LISTER-BURCH.....	370	BUCK CURETTA AURICOLARE.....	407	CASTROVIEJO COLTELLO LANCEOLARE.....	372
BLEFAROSTATO, MELLINGER.....	370	BUCK LEVA PER CORPI ESTRANEI.....	412	CASTROVIEJO COMPASSO.....	380
BLEFAROSTATO, MELLINGER-AXENFELD.....	370	BUCK MARTELLO DA PERCUSSIONE.....	24	CASTROVIEJO FORBICI CORNEALI.....	79
BLEFAROSTATO, MUELLER.....	371	BUCK-GRAMCKO ELEVATORE PER OSSA.....	285	CASTROVIEJO PINZA CAPSULARE.....	391
BLEFAROSTATO, MURDOCK.....	370	BUIE CANNULA D'ASPIRAZIONE RETTALE.....	566	CASTROVIEJO PINZA FISSATRICE.....	390
BLEFAROSTATO, PARK.....	371	BULLDOG PINZA MINI DIETRICH.....	101	CASTROVIEJO PINZA PER SUTURA.....	392
BLEFAROSTATO, SMITH.....	370	BULLDOG PINZA, JOHNS-HOPKINS.....	104	CASTROVIEJO PORT'AGHI.....	215
BLEFAROSTATO, STEVENSON.....	371	BULLDOG PINZE ATTRAUMATICHE.....	100	CASTROVIEJO ROMPIAMETTE.....	45
BLEFAROSTATO, WEEK.....	370	BÜLOW-GUNAR-HEY PINZA SERRATUBI A RULLI.....	130	CASTROVIEJO SPATOLA PER CICLODIALISI.....	379
BLEFAROSTATO, WILLIAMS.....	370	BUMM CURETTE UTERINI.....	597	CASTROVIEJO-MICRO PORT'AGHI.....	215
BLEFAROSTATO, ZIEGLER.....	371	BUNELL ENUCLEATORE PER TENDINI.....	292	CASTROVIEJO-STANDARD PORT'AGHI.....	216
BLOHMKE PINZA PER TONSILLE.....	467	BUNELL GUIDA PER TENDINI.....	294	CATETERE AURICOLARE, HARTMANN.....	408
BLOUNT ELEVATORE PER GINOCCHIO.....	289	BUNELL PERFORATORE A MANO.....	299	CATETERE METALLICO.....	555
BLOUNT ELEVATORE PER OSSA.....	288	BUNGE CUCCHIAIO PER ESTENTERAZIONE.....	378	CATETERE METALLICO, COXETER.....	555
BLUMENTHAL PINZA SGORBIA.....	236	BUNT PINZA PER STERILIZZAZIONE.....	227	CATLUN AMPUTATIONSMESSN.....	44
BODENHAMMER SPECOLO RETTALE.....	559	BURCH UNCINO DI FISSAZIONE.....	373	CAUTERIO WADSWORTH-TODD.....	378
BOEHLER ARCO PER ESTENSIONE.....	312	BURKE PINZA PER BIOPSIA.....	590	CAVO BIPOLARE.....	633
BOERMA FORCIPE.....	604	BUSHE CURETTA TAGLIENTE.....	256	CESIOIA PER GESSI, STILLE.....	229
BOETTCHER FORBICI PER TONSILLE.....	59			CESIOIA PER OSSA STILLE-HORSLEY.....	242
BÖHLER CESIOIA PER OSSA.....	241			CESIOIA PER OSSA STILLE-LISTON.....	242
BÖHLER PINZA SGORBIA.....	238			CESIOIA PER OSSA, BOEHLER.....	241
BOIES ELEVATORE.....	277			CESIOIA PER OSSA, LISTON.....	241
BONACCOLTO PINZA PER STRABISMO.....	385			CESIOIA PER OSSA, MCINDOE.....	241
BONN PINZA PER IRIDE.....	387			CESIOIA PER OSSA, RUSKIN-LISTON.....	241
BONNEY PINZA ANATOMICA.....	88			CESIOIA PER OSSA, SEMB.....	242
BONNEY PINZA CHIRURGICA.....	88			CESIOIA PER OSSA, COTTLE-K.....	241
BOSE DIVARICATORE TRACHEALE.....	476			CESTELLO.....	623
BOUCHERON SPECOLO AURICOLARE.....	399			CESTELLO PER ENDOSCOPI.....	623
BOWMAN AGO PER DISCISIONE.....	374			CESTELLO PER STERILIZZAZIONE.....	622
BOWMAN BLEFAROSTATO.....	370			CHANDLER ELEVATORE.....	282
BOWMAN CHERATOMO.....	372			CHAPUT PINZA PER AFFERRARE TESSUTI.....	110
BOWMAN SPECILLO PER CANALE LACRIMALE.....	381			CHARNLEY DIVARICATORE ADDOMINALE.....	289

CHARRIERE SEGA PER AMPUTAZIONE.....	296	COLTELLO PER AMPUTAZIONE, CATLIN.....	44	CORONAL BLOW DIVARICATORE PER CHIRURGIA PLASTICA.....	198
CHEATLE PINZA PER STERILIZZAZIONE.....	227	COLTELLO PER AMPUTAZIONE, LANGENBECK.....	44	CORWIN-HEGAR PINZA TORCIFILI.....	319
CHELSEA-EATON PROCTOSCOPO.....	563	COLTELLO PER AMPUTAZIONE, HADEO.....	44	CORYLLOS COSTOTOMO.....	480
CHERON PINZA PER MEDICATURA.....	137	COLTELLO PER CARTILAGINE E DISSEZIONE, VIRCHOW.....	48	CORYLLOS DIVARICATORE.....	166
CHERRY DIVARICATORE PER LAMINECTOMIA.....	488	COLTELLO PER CARTILAGINI, LANGENBECK.....	47	COS MIKRO-PINZA AURICOLARE.....	414
CHEVALIER-JACKSON CANNULA TRACHEALE.....	479	COLTELLO PER CATARATTA, DEUTSCHMANN.....	371	COSCIALE.....	295
CHEVALIER-JACKSON PINZA PER BRONCO-ESOFAGOSOFIA.....	473	COLTELLO PER CATARATTA, GRAEFE.....	371	COSTOTOMO.....	480
CHIAVE.....	266	COLTELLO PER CERVELLO.....	48	COSTOTOMO SAUERBRUCH-FREY.....	481
CHIAVI.....	313	COLTELLO PER CHERATOPLASTICA, BARRAQUER.....	373	COSTOTOMO, BETHUNE.....	481
CHILDE PINZA PER AGRAFES.....	224	COLTELLO PER CHERATOPLASTICA, PAUFIQUE.....	373	COSTOTOMO, BRUNNER.....	481
CHIODI PER OSSA.....	309	COLTELLO PER DURA MADRE, KOOS.....	335	COSTOTOMO, CORYLLOS.....	480
CHIODI STEINMANN.....	307, 308	COLTELLO PER FALANGI.....	44	COSTOTOMO, GIERTZ-STILLE.....	481
CINELLI SCALPELLO PER SETTO.....	441	COLTELLO PER GESSI, ESMARCH.....	233	COSTOTOMO, GLUCK.....	480
CISTOTOMO, BECKER.....	375	COLTELLO PER GESSI, HOPKINS.....	233	COSTOTOMO, SAUERBRUCH.....	481
CISTOTOMO, GRAEFE.....	375	COLTELLO PER GESSI, REINER.....	233	COSTOTOMO, STILLE.....	480
CITELLI PINZA TAGLIANTE PER SETTO NASALE.....	430	COLTELLO PER GESSI, WIGMORE.....	229	COTTLE COLUMELLA PINZA.....	448
CLAR LAMPADA FRONTALE.....	22	COLTELLO PER GONIOTOMIA, BARKAN.....	373	COTTLE BULLDOG-FORBICI.....	56
CLARK BLEFAROSTATO 8CM.....	370	COLTELLO PER GONIOTOMIA, SCHEIE.....	373	COTTLE COATELLO NASALE.....	435
CLAUS AGO PER TONSILLE.....	466	COLTELLO PER IRIDE, DEAN.....	372	COTTLE ELEVATORE PER SETTO.....	439
CLAYMAN UNCINO.....	376	COLTELLO PER IRIDE, KNAPP.....	372	COTTLE FORBICI NASALI.....	59
CLEVELAND PINZA SGOBRIA.....	235	COLTELLO PER IRIDE, ZIEGLER.....	372	COTTLE MARTELLO.....	273
CLIPS PER ANEURISMA YASARGIL.....	345- 356	COLTELLO PER MENISCO, NEFF.....	292	COTTLE PINZA DA PRESA.....	410
CLIPS PER VASI, BIEMER.....	361	COLTELLO PER MENISCO, SMILLIE.....	292	COTTLE SCALPELLO PER SETTO.....	440
CLIPS PER VASI, MEHDORN.....	362	COLTELLO PER ORGANI.....	48	COTTLE SPECOLO NASALE.....	423
CLIPS PER VASI, MUELLER.....	364, 365	COLTELLO PER PERIOSTIO CON RASCHINO.....	47	COTTLE UNCINO NASALE.....	447
CLOWARD DIVARICATORE.....	178	COLTELLO PER RESEZIONE.....	47	COTTLE-JOSEPH ELEVATORE PER SETTO.....	439
CLOWARD DIVARICATORE PER CORPI VERTEBRALI.....	339	COLTELLO PER SETTO NASALE, FREER.....	434	COTTLE-KAZANJIAN CESOIA PER OSSA.....	241
CLOWARD PINZA TAGLIANTE PER LAMINECTOMIA.....	342	COLTELLO PER SETTO, BALLENGER.....	436	COTTLE-NEVERT UNCINO NASALE.....	448
COAKLEY ANTRUM CURETTA.....	449	COLTELLO PER TONSILLE, ABRAHAM.....	466	COXETER CATETERE METALLICO.....	555
COAKLEY TREQUARTO PER SENO MASCELLARE.....	204	COLTELLO PER TONSILLE, BRUENINGS.....	466	CRAFOOD-SELLORS PINZA EMOSTATICA.....	119
COBB CURETTA.....	252	COLTELLO PER TONSILLE, CANFIELD.....	466	CRAFOOD FORBICI POLMONARE.....	65/2
COBB PERIOSTOTOMO.....	280	COLTELLO PER TONSILLE, CARPENTER.....	465	CRAFOOD PINZA EMOSTATICA.....	118
COBB SGOBRIA.....	262	COLTELLO PER TONSILLE, DOUGLAS.....	466	CRANIOCLASTO, BRAUN.....	607
COLCLOUGH PINZA TAGLIANTE PER DISCHI INTERVERTEBRALI.....	344/1	COLTELLO PER TONSILLE, FISHER.....	466	CRANIOCLASTO, TARNIER.....	607
COLLER-CRILE PINZA EMOSTATICA.....	106	COLTELLO, PLESTER.....	418	CREGO ELEVATORE.....	282
COLLIER PELVIMETRO.....	605	COLTELLO, ROSEN.....	418	CRILE DIVARICATORE.....	140
COLLIER PORT'AGHI.....	208	COLTELLO, SCHUKNECHT.....	418	CRILE PINZA EMOSTATICA.....	107
COLLIN DINAMOMETRO.....	25	COLTELLO, TABB.....	418	CRILE PORT'AGHI.....	213
COLLIN DIVARICATORE.....	139	COLTELLO, WULLSTEIN.....	418	CRILE UNCINO PER NERVI.....	328
COLLIN DIVARICATORE ADDOMINALE.....	189/1	COLUMELLA PINZA, COTTLE.....	448	CRILE-MURRAY PORT'AGHI.....	209
COLLIN DIVARICATORE ADDOMINALE.....	190	COLVER PINZA PER TONSILLE.....	467	CRILE-RANKIN PINZA EMOSTATICA.....	107
COLLIN ISTEROMETRO.....	586	COMBINAZIONE PER DIAGNOSTICA CON ILLUMINAZIONE ALOGENA, RI-MINI.....	17	CRILE-WOOD PORT'AGHI.....	209
COLLIN LOKITTE DIVARICATORE ADDOMINALE.....	191	COMBINAZIONE PER DIAGNOSTICA CON ILLUMINAZIONE STANDARD ECO "T".....	16	CRITCHETT BLEFAROSTATO.....	370
COLLIN MARTELLO.....	270	COMBINAZIONE PER DIAGNOSTICA CON ILLUMINAZIONE STANDARD UNI I.....	13	CRUTCHFIELD PERFORATORE.....	327
COLLIN PELVIMETRO.....	605	COMBINAZIONE PER DIAGNOSTICA CON ILLUMINAZIONE STANDARD UNI II.....	14	CRUTCHFIELD PINZA PER TRAZIONE CRANIALE.....	327
COLLIN PINZA OMBELICALE.....	605	COMBINAZIONE PER DIAGNOSTICA CON ILLUMINAZIONE STANDARD UNI III.....	15	CUCCHIAIO AURICOLARE, GROSS.....	409
COLLIN PINZA PER AFFERRARE INTESTINI.....	539	COMPASSO, CASTROVIEJO.....	380	CUCCHIAIO OSTETRICO, SELLHEIM.....	607
COLLIN PINZA PER AFFERRARE L'UTERO.....	585	COMPASSO, IWANSON.....	624	CUCCHIAIO PER ABORTO, CUZZI.....	606
COLLIN PINZA PER AFFERRARE TESSUTI.....	110	COMPRESSORE STONE-WATT.....	545	CUCCHIAIO PER ABORTO, WALLICH.....	607
COLLIN PINZA PER AGRAFES.....	224	CONE PINZA PER CRANIOTOMIA.....	331	CUCCHIAIO PER ASPORTAZIONE RETINALE, ARRUGA.....	378
COLLIN PINZA PER MEDICATURA.....	137	CONNIN-AMSLER MARCATORE.....	380	CUCCHIAIO PER CALCOLI BILIARI MOOR.....	532
COLLIN PINZA TIRALINGUA.....	453	CONVERSE COLTELLO NASALE.....	435	CUCCHIAIO PER CALCOLI BILIARI, DESJARDINS.....	534
COLLIN SPECOLO VAGINALE.....	570	CONVERSE UNCINO NASALE.....	448	CUCCHIAIO PER CALCOLI BILIARI, FERGUSSON.....	533
COLLIN-DUVAL PINZA DA PRESA.....	85	COOLEY DILATATORE.....	528	CUCCHIAIO PER CALCOLI BILIARI, LUER-KOERTE.....	533
COLLIN-HARTMANN DIVARICATORE.....	141	COOLEY CANNULA D'ASPIRAZIONE.....	28	CUCCHIAIO PER CALCOLI BILIARI, MAYO.....	534
COLTELLO ADENOIDE BECKMANN.....	450	COOLEY DIVARICATORE.....	148	CUCCHIAIO PER CATERATTA, DAVIEL.....	377
COLTELLO ADENOIDE, BARNHILL.....	450	COOLEY DIVARICATORE COSTALE.....	487	CUCCHIAIO PER CATERATTA, GRAEFE.....	377
COLTELLO ADENOIDE, ST. CLAIR-THOMSON.....	450	COOLEY PINZA CARDIOVASCOLARE ATRAUMATICA.....	518, 519, 522	CUCCHIAIO PER CATERATTA, KNAPP.....	378
COLTELLO AURICOLARE, POLITZER.....	408	COOLEY PINZA PER CATETERI.....	510	CUCCHIAIO PER CATERATTA, WELLS.....	378
COLTELLO AURICOLARE, SEXTON.....	408	COOLEY-DERRA PINZA PER ANASTOMOSI.....	519	CUCCHIAIO PER ESTENTERAZIONE, BUNGE.....	378
COLTELLO FALCATO HADEO.....	435	COOLEY-NEONATAL DIVARICATORE COSTALE.....	485	CUCCHIAIO PER MEDICINALI.....	621
COLTELLO INTEROSSEO.....	44	COOPER AGO PER LEGATURE.....	219	CUCCHIAIO PER SANGUE.....	268
COLTELLO LANCEOLARE, BERENS.....	372	COPERCHIO PER PADELLA.....	621	CUCCHIAIO UTERINO GOURDET.....	599
COLTELLO LANCEOLARE, BOWMAN.....	372	CORDA DI TRAZIONE.....	201	CUCCHIAIO UTERINO SCHRÖDER.....	595
COLTELLO LANCEOLARE, CASTROVIEJO.....	372	CORDES INSERTO.....	472	CUCCHIAIO UTERINO, SIMON.....	594
COLTELLO LANCEOLARE, JAEGER.....	372			CULLER SPATOLA PER IRIDE.....	378
COLTELLO LANCEOLARE, WHEELER.....	373			CURETTA ANTRUM.....	435
COLTELLO LANCEOLARE, ZIEGLER.....	373			CURETTA ANTRUM, COAKLEY.....	449
COLTELLO NASALE, CONVERSE.....	435			CURETTA AURICOLARE, BUCK.....	407
COLTELLO NASALE, COTTLE.....	435			CURETTA COBB.....	252
COLTELLO PER AMPUTAZIONE LISTON.....	44			CURETTA DA CALAZIO, AXENFELD.....	377

CURETTA DA CALAZIO, HEBRA	377	DE BAKEY PINZA VASCOLARE	493, 494, 495, 496, 497,498, 499, 500, 505, 507, 508, 514, 515, 516, 517,	DILATATORE UTERINO PRATT	580
CURETTA DA CALAZIO, MEYHOEFER	377	DE BAKEY PORT'AGHI	210	DILATATORE UTERINO SIMS	581
CURETTA PER ABORTO, PESTALOZZA	606	DE BAKEY, PINZA ATRAUMATICA BULLDOG	100	DILATATORE UTERINO WYLIE	581
CURETTA PER BIOPSIA ED ASPIRAZIONE	600	DE BAKEY, PINZE ATRAUMATICHE	98	DILATATORE VASCOLARE DEBAKEY	529
CURETTA PER BIOPSIA, HEANY	587	DE BOER DIVARICATORE COSTALE	486	DINAMOMETRO, COLLIN	25
CURETTA PER BIOPSIA, KEVORKIAN	587	DE BOER DIVARICATORE	486	DINGMAN ELEVATORE	463/3
CURETTA PER BIOPSIA, MOD.MÜNCHEN	587	DE LEE FORCIPE	602	DINGMANN ABBASSALINGUA	456
CURETTA PER BIOPSIA, NOVAK	587	DE MARTEL STRUMENTO CONDUTTRICE	330	DINGMANN APRIBOCCA	456
CURETTA PER BIOPSIA, RANDALL	587	DE MARTEL STRUMENTO CONDUTTRICE	330	DINGMANN DIVARICATORE	463
CURETTA PER CORPI ESTRANEI ALVIS	374	DE MARTEL-WOLFSON PINZA PER ANASTOMOSI	546	DINGMANN PERIOSTOTOMO	463
CURETTA PER IPOFISI	334	DEAN COLTELLO PER IRIDE	372	DINGMANN TENAGLIA PER OSSA	246
CURETTA PER LUPUS, FOX	608	DEAN FORBICI PER TONSILLE	59	DIPLOMAT SFIGMOMANOMETRO	5
CURETTA PER LUPUS, PIFFARD	608	DEAVER DIVARICATORE	145	DISSETTORE CORNEALE, PATON	373
CURETTA TAGLIANTE BRUNS	251, 254	DEAVER FORBICI PER DISSEZIONE	52	DISSETTORE CORNEALE, ELSCHNIG	373
CURETTA TAGLIANTE DOPPIA VOLKMANN	257	DEAVER-GRIP DIVARICATORE	146	DISSETTORE CORNEALE, GILL	373
CURETTA TAGLIANTE VOLKMANN	251	DEBAKEY FORBICI VASCOLARI	61	DISSETTORE CORNEALE, GREEN	374
CURETTA TAGLIANTE WILLIGER	255	DEBAKEY FORBICI VASCOLARI TC	60	DISSETTORE CORNEALE, SATO	373
CURETTA TAGLIANTE, BÜSHE	256	DEBAKEY PINZA PER ANASTOMOSI	505	DISSETTORE CORNEALE, TOOK	373
CURETTA TAGLIANTE, DAUBENSPECK	255	DEBAKEY-BAHNSON PINZA ANEURISMA	506	DISSETTORE GORNEY	277
CURETTA TAGLIANTE, HALLE	253	DEBAKEY-DIETHRICH MINI PINZA BULLDOG	101	DISSETTORE PER SACCO LACRIMALE, LANG	378
CURETTA TAGLIANTE, JACOBSON	257	DEBAKEY-MOSQUITO PINZA EMOSTATICA	509	DISSETTORE PER TONSILLE, HURD	465
CURETTA TAGLIANTE, JANSEN	257	DEBAKEY-PEAN PINZA EMOSTATICA	513	DISSETTORE PER TONSILLE, LOPEZ-REINKE	465
CURETTA TAGLIANTE, LEMPERS	256	DEBAKEY-RANKIN PINZA EMOSTATICA	512	DISSETTORE PER TONSILLE, YANKAUER	465
CURETTA TAGLIANTE, MARTINI	257	DEBAKEY-SATINSKY PINZA PER OCCLUSIONE TANGENZIALE	502	DISSETTORE, FISCH	420
CURETTA TAGLIANTE, SCHEDE	251	DEJERINE MARTELLO DA PERCUSSIONE	24	DISSETTORE, PENFIELD	333
CURETTA TAGLIANTE, SCOVILLE	253	DELEE DIVARICATORE	574	DISTRIBUTORE PER PERFORATORI FILIFORMI	310
CURETTA TAGLIANTE, SPINAL	253	DELEE AGO PASSAFILI	315	DISTRIBUTORE PER SPAZZOLINI	611
CURETTA TAGLIANTE, SPRATT	251	DEMELE STRUMENTO TENDIFILI	315	DITTEL CANDELETTA DILATATRICE	554
CURETTA, FAULKNER	449	DENHART APRIBOCCA	454	DIVARICATORE	463/3
CURETTA, HOUSE	420	DENIS-BROWNE DIVARICATORE ADDOMINALE	185	DIVARICATORE ADDOMINALE BABY GOSSET	181
CURETTE UTERINI, BLAKE	595	DEPRESSORE PER EPIGLOTTIDE, REICHERT	471	DIVARICATORE ADDOMINALE BALFOUR	182
CURETTE UTERINI, BUMM	597	DEPRESSORE UTERINO, BRAUN	586	DIVARICATORE ADDOMINALE BALFOUR	183
CURETTE UTERINI, RECAMIER	597	DEPRESSORE UTERINO, SIMS	586	DIVARICATORE ADDOMINALE BALFOUR-BUS	182
CURETTE UTERINI, SIMS	597, 598	DERF PORT'AGHI	208	DIVARICATORE ADDOMINALE BALFOUR-US	184
CURETTE UTERINI, THOMAS	599	DERMATOMO, HUMBY	50	DIVARICATORE ADDOMINALE CHARNELY	289
CUSCO SPECOLO VAGINALE	570, 571	DERMATOMO, SILVER	50	DIVARICATORE ADDOMINALE COLLIN	190
CUSHING (TAYLOR) PINZA TC	87	DERMATOMOO, SCHINK	49	DIVARICATORE ADDOMINALE COLLIN-LOKTTITE	191
CUSHING DIVARICATORE	151	DERRA PINZA CARDIOVASCOLARE ATRAUMATICA	515	DIVARICATORE ADDOMINALE COMPLETO KIRSCHNER	187/1
CUSHING DIVARICATORE	152	D'ERRICO UNCINO PER NERVI	329/2	DIVARICATORE ADDOMINALE DENIS-BROWNE	185
CUSHING DIVARICATORE	153	DESCHAMPS AGO PER LEGATURE	218	DIVARICATORE ADDOMINALE FRAZIER	181
CUSHING PERFORATORE	299	DESJARDINS CUCCHIAIO PER CALCOLI BILIARI	534	DIVARICATORE ADDOMINALE GELPI	189/2
CUSHING PINZA ANATOMICA	83	DESJARDINS PINZA EMOSTATICA	121	DIVARICATORE ADDOMINALE GOSSET	181
CUSHING PINZA CHIRURGICA	83	DESJARDINS PINZA PER CALCOLI BILIARI	531	DIVARICATORE ADDOMINALE HORGAN	183
CUSHING PINZA TAGLIANTE PER LAMINECTOMIA	340	DESJARDINS SONDA PER CALCOLI BILIARI	532	DIVARICATORE ADDOMINALE JACKSON BURROWS	189/2
CUSHING SPATOLA CEREBRALE	369	DESMARRES DIVARICATORE	151	DIVARICATORE ADDOMINALE KIRSCHNER	185
CUSHING UNCINO PER NERVI	328	DESMARRES PINZA PER CALAZIO	393	DIVARICATORE ADDOMINALE RICARD	191
CUZZI CUCCHIAIO PER ABORTO	606	DEUTSCHMANN COLTELLO PER CATARATTA	371	DIVARICATORE ADDOMINALE RIGBY	189/2
CZERNY PINZA PER ABBASSARE IL COLLO DELL'UTERO	584	DEVILBISS PINZA PER CRANIOTOMIA	332	DIVARICATORE ADDOMINALE ROCHARD	186
CZERNY SPECOLO RETTALE	559	DEVILBISS PINZA PER CRANIOTOMIA	332	DIVARICATORE ADDOMINALE, DE BAKEY	189/1
D		DIAPASON	404	DIVARICATORE ADDOMINALE, DOYEN	189/1
DANDY PINZA EMOSTATICA	109	DIAPASON, HARTMANN	403	DIVARICATORE ADDOMINALE, GELPI	189/1
DANDY UNCINO PER NERVI	328	DIAPASON, LUCAE	404	DIVARICATORE ADDOMINALE, SET COMPLETO, CON MORSETTI E VALVE	193
DARLING DIVARICATORE	178	DIAPASON, HADEO	403	DIVARICATORE ADDOMINALE, SET COMPLETO, CON SISTEMA DI MONTAGGIO	192
DARTIGUES PINZA PER AFFERRARE L'UTERO	585	DIAPASONN, RYDEL-SEIFFERT	404	DIVARICATORE ADSON	172
DASTOOR PINZA PER STRABISMO	386	DIFFENBACH PINZA VASCOLARE	104	DIVARICATORE ADSON	174
DAUBENSPECK CURETTA TAGLIANTE	255	DIETER MIKRO-PINZA AURICOLARE	414	DIVARICATORE ANALE, SMITH-BUIE	561
DAVIDSON(SCAPULA) DIVARICATORE	166	DIETRICH PINZA MINI BULLDOG	101	DIVARICATORE AUFRANC-COBRA	289
DAVIEL CUCCHIAIO PER CATERATTA	377	DIETRICH FORBICI VASCOLARI	60	DIVARICATORE COLLIN	139
DAVIS AGO PER CORPI ESTRANEI	374	DIETRICH PINZA AORTA	510	DIVARICATORE COSTALE, COOLEY	487
DAVIS DURA DISSETTORE	332	DILATATOR TRACHEALE LABORDE	476	DIVARICATORE COSTALE, COOLEY-NEONATAL	485
DAVIS PINZA PER STERILIZZAZIONE	227	DILATATORE COOLEY	528	DIVARICATORE COSTALE, DE BOER	486
DAVIS SPATOLA CEREBRALE	337	DILATATORE PER CANALE LACRIMALE, WILDER	381	DIVARICATORE COSTALE, FINOCHIETTO-BURFORD	483
DAVIS-BOYLE ABBASSALINGUA	455	DILATATORE PER CANALE LACRIMALE, ZIEGLER	381	DIVARICATORE COSTALE, HAIGHT	487
DAVIS-BOYLE APRIBOCCA	455	DILATATORE PER CANALE LACRIMALE, CASTROVIEJO	381	DIVARICATORE COSTALE, MORSE	484
DAVIS-MEYER APRIBOCCA	457	DILATATORE PER CONDOTTI BILIARE, BAKES	532	DIVARICATORE COSTALE, MORSE-FAVALORO	484
DAY UNCINO	409	DILATATORE PER SENO FRONTALE RITTER-HALLE	433	DIVARICATORE COSTALE, RIENHOFF-FINOCHIETTO	486
DE BAKEY PINZE ATRAUMATICHE BULLDOG	103	DILATATORE TRACHEALE, TROUSSEAU-BABY	476	DIVARICATORE COSTALE, TUFFIER	487
DE BAKEY PINZE ATRAUMATICHE IN TITANIO	99	DILATATORE TRACHEALE, TROUSSEAU	476	DIVARICATORE CUSHING	152
DE BAKEY CANNULA D'ASPIRAZIONE	28	DILATATORE TUBBS	528	DIVARICATORE CUSHING	153
DE BAKEY DILATATORE VASCOLARE	529	DILATATORE UTERINO GOODELL	581	DIVARICATORE DELEE	574
DE BAKEY DIVARICATORE ADDOMINALE	189/1	DILATATORE UTERINO HANK	580		
		DILATATORE UTERINO HEGAR	578, 579		

DIVARICATORE FINSEN	168	DIVARICATORE, COOLEY.....	148	DOYEN PINZA INTESTINALE	540
DIVARICATORE HARRINGTON-PEMBERTON	147	DIVARICATORE, CORYLLOS	166	DOYEN PINZA PER POLIPI UTERINI	585
DIVARICATORE KIRSCHNER.....	187	DIVARICATORE, CRILE	140	DOYEN SPECILLO SCANALATO	199
DIVARICATORE KOCHER	155	DIVARICATORE, CUSHING.....	151	DOYEN SPECOLO VAGINALE	574
DIVARICATORE KOCHER	159	DIVARICATORE, DARLING.....	178	DOYEN TIRAMIOMI.....	594
DIVARICATORE KOCHER	160	DIVARICATORE, DAVIDSON (SCAPULA).....	166	DOYEN-BABY PINZA INTESTINALE	540
DIVARICATORE KOCHER	163	DIVARICATORE, DEAVER.....	145	DOYEN-JANSEN(MOLT) APRIBOCCA.....	454
DIVARICATORE KÖNIG	153	DIVARICATORE, DEAVER GRIP	146	DOYEN-JANSEN(MOLT) APRIBOCCA.....	454
DIVARICATORE LANGENBECK	158	DIVARICATORE, DESMARRS	151	DOYEN-STILLE	167
DIVARICATORE LANGENBECK	159	DIVARICATORE, DINGMANN.....	463	DUBOIS FORBICI GINECOLOGICHE.....	63
DIVARICATORE MARTIN.....	175/1	DIVARICATORE, DOYEN.....	163	DUPLAX PINZA PER ABBASSARE IL COLLO	
DIVARICATORE MAYO-ADAMS	171	DIVARICATORE, DOYEN-STILLE	167	DELL'UTERO	582
DIVARICATORE MEYERDING	157	DIVARICATORE, FARABEUF	139	DUPLAX PINZA PER MEDICATURA	134
DIVARICATORE MEYERDING	177	DIVARICATORE, FRITSCH.....	163	DUPLEX STETOSCOPIO.....	23
DIVARICATORE MURPHY	156	DIVARICATORE, GIL-VERNET	152	DUPUY-WEISS AGO PER TONSILLE	466
DIVARICATORE NORFOLK-NORDWICH	172	DIVARICATORE, GOELET	141	DURA DISSETTORE	332
DIVARICATORE OBWEGESER.....	460, 461	DIVARICATORE, GREEN.....	160	DURA DISSETTORE, DAVIS.....	332
DIVARICATORE PELVICO, ST.MARKS.....	165	DIVARICATORE, HARRINGTON.....	147	DURA DISSETTORE, FRAZIER	333
DIVARICATORE PER CHIRURGIA PLASTICA BREAST	198	DIVARICATORE, HEANEY	164	DURA DISSETTORE, HOEN	333
DIVARICATORE PER CHIRURGIA PLASTICA CORONAL		DIVARICATORE, HENLEY	170	DURA DISSETTORE, HORSLEY.....	333
BLOW	198	DIVARICATORE, HIBBS	164	DURA DISSETTORE, MILLIGAN	332
DIVARICATORE PER CHIRURGIA PLASTICA FERRIERA	197	DIVARICATORE, HOESEL	167	DURA DISSETTORE, OLIVECRONA	332
DIVARICATORE PER CHIRURGIA PLASTICA FREEMAN	198	DIVARICATORE, HOFER	465	DURA DISSETTORE, SACHS	332
DIVARICATORE PER CHIRURGIA PLASTICA TEBBETS	197	DIVARICATORE, HOLZHEIMER	168	DURA DISSETTORE, TOENNIS	332
DIVARICATORE PER CHIRURGIA PLASTICA		DIVARICATORE, ISRAEL	162	DURA DISSETTORE, WOODSON	333
YANCOSKIE	198	DIVARICATORE, JANSEN	168	DURANTE PINZA DA PRESA.....	88
DIVARICATORE PER CORPI VERTREBRALI, CLOWARD	339	DIVARICATORE, KELLY	164	DUVAL PINZA DA PRESA.....	85
DIVARICATORE PER CORPI VERTREBRALI, INGE	339	DIVARICATORE, KELLY GRIP	142	DUVAL PINZA PER AFFERRARE INTESTINI	539
DIVARICATORE PER GESSI HADEO.....	232	DIVARICATORE, KOCHER-LANGENBECK.....	159		
DIVARICATORE PER GESSI, BEESON	232	DIVARICATORE, KOERTE	162	E	
DIVARICATORE PER GESSI, HAGLUND-STILLE	232	DIVARICATORE, LAHEY	157	ECHLIN PINZA SGORBIA	240
DIVARICATORE PER GESSI, HENNING.....	232	DIVARICATORE, LITTLE	157	ECO "T" COMBINAZIONE PER DIAGNOSTICA CON	
DIVARICATORE PER GUANCE, STERNBERG.....	453	DIVARICATORE, LOVE	465	ILLUMINAZIONE STANDARD.....	16
DIVARICATORE PER LA PROSTATA, YOUNG	550	DIVARICATORE, MATHIEU.....	141	ELETTRODO A BISTURI	628, 629
DIVARICATORE PER LABBRA	453	DIVARICATORE, MEYERDING	180	ELETTRODO A SFERA MONOPOLARE	628, 629
DIVARICATORE PER LAMINECTOMIA SCOVILLE	196	DIVARICATORE, MIDDELDORFF.....	160	ELETTRODO AD AGO MONOPOLARE	628, 629
DIVARICATORE PER LAMINECTOMIA		DIVARICATORE, MIKULICZ	163	ELETTRODO AD ANSA MONOPOLARE.....	628, 629
SCOVILLE-HAVERFIELD	196	DIVARICATORE, MOLLISON	171	ELETTRODO LANGEOLATA MONOPOLARE.....	628, 629
DIVARICATORE PER LAMINECTOMIA, CHERRY.....	488	DIVARICATORE, MORRIS	164	ELEVATORE AURICOLARE ZAUFAL	409
DIVARICATORE PER SPINA CERVICALE CASPAR	179	DIVARICATORE, NAGER	465	ELEVATORE AURICOLARE ZAUFAL-JANSEN	409
DIVARICATORE PER SPINA CERVICALE CASPAR	180	DIVARICATORE, OLLIER	162	ELEVATORE CHANDLER	282
DIVARICATORE PER TIROIDE, SCHOENBORN	479	DIVARICATORE, PARKER	139	ELEVATORE DINGMAN.....	463/3
DIVARICATORE PER TORACE, MERCEDES	489	DIVARICATORE, PLESTER.....	171	ELEVATORE PER GINOCCHIO, BLOUNT.....	289
DIVARICATORE PERKINS	168	DIVARICATORE, RAGNELL	140	ELEVATORE PER OSSA	286/1
DIVARICATORE ROSE	140	DIVARICATORE, RAMUS	461	ELEVATORE PER OSSA BUCK-GRAMCKO	285
DIVARICATORE SAUERBRUCH.....	164	DIVARICATORE, RICHARDSON.....	142	ELEVATORE PER OSSA LANE	290
DIVARICATORE SAUERBRUCH.....	166	DIVARICATORE, RICHARDSON GRIP	142	ELEVATORE PER OSSA LANE TRETOWAN	290
DIVARICATORE SCALP-CONTOUR	169	DIVARICATORE, RICHARDSON-EASTMAN	142	ELEVATORE PER OSSA LANGE-HOHMANN	286
DIVARICATORE SPINALE, TAYLOR	291	DIVARICATORE, ROUX	139	ELEVATORE PER OSSA VERBRUGGE-MÜLLER.....	286/2
DIVARICATORE STRANDELL-STILLE	157	DIVARICATORE, ROUX-BABY	140	ELEVATORE PER OSSA, BENNETT.....	283
DIVARICATORE TESSIER.....	463/3	DIVARICATORE, ROUX-MINI	140	ELEVATORE PER OSSA, BLOUNT	288
DIVARICATORE TRACHEALE	476	DIVARICATORE, SENN-GREEN	153	ELEVATORE PER OSSA, BRISTOW	290
DIVARICATORE TRACHEALE, ITERSON.....	477	DIVARICATORE, SENN-MILLER	143	ELEVATORE PER OSSA, HOHMANN	284, 285
DIVARICATORE TRACHEALE, JACKSON.....	476	DIVARICATORE, SIMON.....	164	ELEVATORE PER OSSA, HOHMANN	284, 285
DIVARICATORE TRACHEALE, NEWS.....	477	DIVARICATORE, SPINA-NASALIS	461	ELEVATORE PER OSSA, HOHMANN MINI	286
DIVARICATORE TRAVERS	172	DIVARICATORE, VOLKMANN	153	ELEVATORE PER OSSA, KOENIG	284
DIVARICATORE TUFFIER	147	DIVARICATORE, VOLKMANN	154	ELEVATORE PER OSSA, SMILLIE	291
DIVARICATORE VESCICALE, LEGUE	553	DIVARICATORE, WEITLANER	169	ELEVATORE PER PERIOSTIO	463/2
DIVARICATORE VESCICALE, MILLIN	552	DIVARICATORE, WEITLANER-WULLSTEIN.....	169	ELEVATORE PER SETTO FREER	437, 438
DIVARICATORE VESCICALE, MILLIN	553	DIVARICATORE, ZENKER	161	ELEVATORE PER SETTO HOWARTH	438
DIVARICATORE VESCICALE, THOMSON-WALKER.....	552	DIVARICATORE, US-ARMY PARKER-LANG.....	141	ELEVATORE PER SETTO MCKENTY	437
DIVARICATORE VESCICALE, JUDD-MASSON	552	DIVISORE PER CRANIO	267	ELEVATORE PER SETTO SINUS	438
DIVARICATORE VOLKMANN.....	156	DIX SGORBIA PER CORPI ESTRANEI	374	ELEVATORE PER SETTO, BALLENGER	439
DIVARICATORE WULLSTEIN	171	DIX STRUMENTI PER CORPI ESTRANEI	380	ELEVATORE PER SETTO, COTTLE	439
DIVARICATORE, ADSON.....	173	DOUGHTY ABBASSALINGUA	458	ELEVATORE PER SETTO, COTTLE-JOSEPH	439
DIVARICATORE, ALM.....	168	DOUGLAS COLTELLO PER TONSILLE	466	ELEVATORE PER SETTO, HAJEK-BALLENGER	439
DIVARICATORE, ANDERSON-ADSON.....	172	DOUGLAS PINZA DEPILATORIA	395	ELEVATORE PER SETTO, HALLE	437
DIVARICATORE, BECKMANN.....	176	DOYEN DIVARICATORE.....	163	ELEVATORE PER SETTO, JOSEPH	437
DIVARICATORE, BECKMANN-ADSON	175	DOYEN DIVARICATORE ADDOMINALE	189/1	ELEVATORE PER SETTO, KILLIAN.....	438
DIVARICATORE, BECKMANN-EATON.....	176	DOYEN FORBICI GINECOLOGICHE	63	ELEVATORE PER SETTO, PENNINGTON.....	438
DIVARICATORE, BRUNNER	167	DOYEN PERIOSTOTOMO	278	ELEVATORE PER SETTO, PIERCE	438
DIVARICATORE, CLOWARD	178	DOYEN PERIOSTOTOMO	278	ELEVATORE PER SETTO, ROGER	437
DIVARICATORE, COLLIN HARTMANN	141	DOYEN PINZA FISSATELI.....	133	ELEVATORE PER TONSILLE, HENKE	465

ELEVATORE QUERVAIN.....	275	FISCH UNCINO.....	335	FORBICI PER DISSEZIONE, LEXER.....	53
ELEVATORE SEBILEAU.....	275	FISCH DISSETTORE.....	420	FORBICI PER DISSEZIONE, LEXER-BABY.....	53
ELEVATORE, ALDERDYCE.....	282	FISCHER PINZA PER IRIDE.....	384	FORBICI PER DISSEZIONE, LEXER-BABY TC.....	53
ELEVATORE, BOIES.....	277	FISH SPECILLO.....	199	FORBICI PER DISSEZIONE, MAYO-NOBLE.....	52
ELEVATORE, CREGO.....	282	FISHER COLTELLO PER TONSILLE.....	466	FORBICI PER DISSEZIONE, METZENBAUM.....	53/1
ELEVATORE, FREER.....	434	FOERSTER PINZA PER IRIDE.....	383	FORBICI PER DISSEZIONE, METZENBAUM FINO.....	53/1
ELEVATORE, KEY.....	282	FOERSTER PINZA PER MEDICATURA.....	136	FORBICI PER DISSEZIONE, METZENBAUM TC.....	53/1
ELEVATORE, LEMPERS.....	420	FOMON FORBICI NASALI.....	58	FORBICI PER DISSEZIONE, TOENNIS-ADSON.....	65
ELEVATORE, McDONALD, 19CM.....	283	FOMON FORBICI PER RINOPLASTICA.....	65/1	FORBICI PER DISSEZIONE, WELLER.....	53/2
ELEVATORE, MURPHY-LANE.....	283	FOMON PERIOTOTOMO.....	277	FORBICI PER DISSEZIONE, METZENBAUM FINO TC.....	53/1
ELEVATORE, SAYRE.....	281	FOMON RASPA NASALE.....	444	FORBICI PER DURAMADRE, SCHMIEDEN-TAYLOR.....	65/1
ELEVATORE, WATSON-CHEYNE.....	283	FOMON SCALPELLO PER SETTO.....	441	FORBICI PER ENTEROTOMIA.....	66
ELLIOT FORCIPE.....	602	FOMON TC RASPA NASALE.....	445	FORBICI PER EPISIOTOMIA, BRAUN-STADLER.....	64
ELLIS SGORBIA PER CORPI ESTRANEI.....	374	FOMON UNCINO PER LA PELLE.....	447/1	FORBICI PER EPISIOTOMIA, WALDMANN.....	64
ELSCHING DISSETTORE CORNEALE.....	373	FORBICE PER IL SETTO NASALE, KILLIAN.....	471	FORBICI PER FILO DI METALLO E LAMIERA, UNIVERSAL.....	67
ELSCHING SPATOLA PER CICLODIALISI.....	379	FORBICE PER LE UNGHIE.....	609	FORBICI PER INCISIONE.....	52
ELSCHNIG PINZA CAPSULARE.....	391	FORBICE PER PELLE.....	610	FORBICI PER ISTERECTOMIA, WERTHEIM.....	63
ELSCHNIG PINZA FISSATRICE.....	389	FORBICI BULLDOGS COTTLE.....	56	FORBICI PER LEGATURE, HEATH.....	66
EMMETT UNCINO PER FISTOLE.....	594	FORBICI CORNEALI, CASTROVIEJO.....	79	FORBICI PER LEGATURE, LITTAUER.....	66
ENDOSPECOLO KOGAN.....	577	FORBICI GINECOLOGICHE, DOYEN.....	63	FORBICI PER LEGATURE, NORTHBENT.....	66
ENGEL SEGA PER GESSI.....	229	FORBICI GINECOLOGICHE, DUBOIS.....	63	FORBICI PER LEGATURE, SPENCER.....	66
ENUCLEATORE PER TENDINI, BRAND.....	294	FORBICI GINECOLOGICHE, SIEBOLD.....	62	FORBICI PER NEUROCHIRURGIA.....	65
ENUCLEATORE PER TENDINI, BUNELL.....	292	FORBICI GINECOLOGICHE, SIMS.....	62	FORBICI PER NEUROCHIRURGIA, STRULLY.....	65
EPKER OSTEOTOMI.....	464/2	FORBICI GINGIVALI, GOLDMAN-FOX.....	67	FORBICI PER OFTALMOLOGIA.....	57
EPENDORFFER PINZA PER BIOPSIA.....	590	FORBICI GINGIVALI, LA GRANGE.....	69	FORBICI PER OFTALMOLOGIA GRADLE.....	57
ERRICO PERFORATORE.....	299	FORBICI GINGIVALI, LOCKLIN.....	69	FORBICI PER OFTALMOLOGIA, AEBLI.....	58
ESMARCH BENDA PER COMPRESSIONE.....	297	FORBICI GINGIVALI, QUINBY.....	67	FORBICI PER OFTALMOLOGIA, STEVENS.....	58
ESMARCH COLTELLO PER GESSI.....	233	FORBICI GRAEFE.....	56	FORBICI PER PARAMETRIO.....	63
ESMARCH FORBICI PER BENDAGGI.....	69/2	FORBICI NASALI.....	429	FORBICI PER RINOPLASTICA FOMON.....	65/1
ESTENSIONE DELL'ARTICOLAZIONE.....	188	FORBICI NASALI, COTTLE.....	59	FORBICI PER STERNO SCHUMACHER.....	481
ESTRATTATORE, KUENTSCHER.....	322	FORBICI NASALI, FOMON.....	58	FORBICI PER STRABISMO.....	58
ETHICON PINZA APPLICATORE CLIPS.....	524, 525	FORBICI NASALI, HEYMANN.....	58	FORBICI PER STRABISMO.....	58
EVES SERRANODI PER TONSILLE.....	468	FORBICI NASALI, WESTCOTT.....	75	FORBICI PER TONSILLE.....	59
EXACTA SFIGMOMANOMETRO.....	8	FORBICI OCULISTICHE, BARRAQUER.....	75	FORBICI PER TONSILLE, BOETTCHER.....	59
		FORBICI OCULISTICHE, NOYES.....	75	FORBICI PER TONSILLE, DEAN.....	59
F		FORBICI OCULISTICHE, VANNAS.....	79	FORBICI PER TONSILLE, GOOD.....	59
FACE LIFT FORBICI FREEMAN.....	74	FORBICI OCULISTICHE, WECKER.....	75	FORBICI PER TONSILLE, PRINCE.....	59
FACE LIFT FORBICI GORNEY.....	73	FORBICI PER BENDAGGI.....	70	FORBICI PER TONSILLE, CRAFOORD.....	65/2
FACE LIFT FORBICI KAYE.....	73	FORBICI PER BENDAGGI, BERGMANN.....	69/1	FORBICI TORACALI, THOREK.....	65/2
FACE LIFT FORBICI REES.....	73	FORBICI PER BENDAGGI, BRUNS.....	70	FORBICI VASCOLARI DEBAKEY TC.....	60
FANSLER PROCTOSCOPO.....	565	FORBICI PER BENDAGGI, ESMARCH.....	69/2	FORBICI VASCOLARI, DE BAKEY.....	61
FARABEUF DIVARICATORE.....	139	FORBICI PER BENDAGGI, KNOWLES.....	70	FORBICI VASCOLARI, DIETRICH.....	60
FARABEUF PERIOTOTOMO.....	274	FORBICI PER BENDAGGI, LISTER.....	69/1	FORBICI VASCOLARI, FAVALORO.....	61
FARABEUF TENAGLIA PER OSSA.....	243	FORBICI PER BENDAGGI, LORENZ.....	70	FORBICI VASCOLARI, KELLY.....	61
FARABEUF-COLLIN PERIOTOTOMO.....	274	FORBICI PER BENDAGGI, HADEO EXCENTER.....	69/2	FORBICI VASCOLARI, KLINKENBERG-LOTH.....	65/2
FARABEUF-LAMBOTTE TENAGLIA PER OSSA.....	243	FORBICI PER BENDAGGI, SEUTIN.....	69/2	FORBICI VASCOLARI, POTTS-DE MARTEL.....	59
FARRELL PORTACOTONE.....	203	FORBICI PER BENDAGGI, SMITH US ARMY.....	69/1	FORBICI VASCOLARI, POTTS-SMITH.....	61
FAULKNER CURETTA.....	449	FORBICI PER BENDAGGI, UNIVERSAL.....	70	FORBICI VASCOLARI, SATINSKY.....	65/2
FAURE PINZA PER BIOPSIA.....	588	FORBICI PER CAPSULA, RESANO.....	53/2	FORBICI WAGNER.....	67
FAURE PINZA PERITONEALE.....	123	FORBICI PER CARTILAGINE, MARTIN.....	65/1	FORCIPE, BARTON.....	603
FAVALORO FORBICI VASCOLARI.....	61	FORBICI PER CARTILAGINE, MCINDOE.....	65/1	FORCIPE, BOERMA.....	604
FEHLAND PINZA INTESTINALE.....	542	FORBICI PER CHIRURGIA FINE, IRIS.....	54	FORCIPE, DE LEE.....	602
FEILCHENFELD PINZA PER SCHEGGE.....	91	FORBICI PER CHIRURGIA FINE, JOSEPH.....	54	FORCIPE, ELLIOT.....	602
FELDHEIM PINZA PER OSSA.....	249	FORBICI PER CHIRURGIA FINE, KILNER.....	54	FORCIPE, KIELLAND.....	602
FERGUSSON CUCCHIAIO PER CALCOLI BILIARI.....	533	FORBICI PER CHIRURGIA FINE, REYNOLDS.....	54	FORCIPE, KIELLAND-LUIKART.....	603
FERGUSSON FORBICI PER CHIRURGIA.....	66	FORBICI PER CHIRURGIA FINE, SANVENERO.....	54	FORCIPE, LUIKART.....	603
FERGUSSON FRAZIER CANNULA D'ASPIRAZIONE.....	337	FORBICI PER CHIRURGIA STANDARD.....	51	FORCIPE, MCLEAN.....	603
FERGUSSON PINZA EMORROIDALE.....	109	FORBICI PER CHIRURGIA, FERGUSSON.....	66	FORCIPE, MCLEAN-LUIKART.....	603
FERGUSSON TENAGLIA PER OSSA.....	243	FORBICI PER CHIRURGIA, METZENBAUM.....	54	FORCIPE, MCLEAN-LUIKART.....	603
FERRIERA DIVARICATORE PER CHIRURGIA PLASTICA.....	197	FORBICI PER CHIRURGIA, SYSTRUNK.....	66	FORCIPE, MCLEAN-TUCKER.....	603
FERRIS-SMITH PINZA CHIRURGICA.....	84	FORBICI PER CORDA OMBELICALE, BUSCH.....	64	FORCIPE, MCLEAN-TUCKER-LUIKART.....	603
FERRIS-SMITH PINZA TAGLIANTE PER LAMINECTOMIA.....	343	FORBICI PER CORDA OMBELICALE, MOD.USA.....	64	FORCIPE, NAEGELE.....	602
FERRIS-SMITH-KERRISON PINZA TAGLIANTE PER DISCHI INTERVERTEBRALI.....	344, 344/2	FORBICI PER CORDA OMBELICALE, SCHUMACHER.....	64	FORCIPE, PIPER.....	604
FICHOCHIETTO-BABY DIVARICATORE COSTALE.....	482	FORBICI PER CORONA, BEEBEE.....	68	FORCIPE, SIMPSON.....	602
FILO PER OSSA.....	314	FORBICI PER DISSEZIONE.....	52	FORCIPE, SIMPSON-BRAUN.....	602
FINOCCHIETTO DIVARICATORE COSTALE.....	482, 484	FORBICI PER DISSEZIONE DEEVER.....	52	FORCIPE, SIMPSON-LUIKART.....	603
FINOCCHIETTO PINZA PER BRONCHI.....	490	FORBICI PER DISSEZIONE MAYO.....	52	FORCIPE, WRIGLEY.....	602
FINOCCHIETTO DIVARICATORE COSTALE.....	484	FORBICI PER DISSEZIONE MAYO, TC.....	52	FOREGGER LARINGSOCOPIO.....	29
FINOCCHIETTO PORT'AGHI.....	211	FORBICI PER DISSEZIONE MAYO, STILLE.....	52	FOREGGER LARINGSOCOPIO SET.....	31
FINOCCHIETTO-BURFORD DIVARICATORE COSTALE.....	483	FORBICI PER DISSEZIONE MAYO-STILLE.....	52	FOX CURETTA PER LUPUS.....	608
FINSEN DIVARICATORE.....	168	FORBICI PER DISSEZIONE MAYO-STILLE, TC.....	52	FRAENKEL INSERTO.....	472
		FORBICI PER DISSEZIONE METZENBAUM.....	53/1	FRAENKEL PINZA PER POLIPI LARINGEI.....	471
		FORBICI PER DISSEZIONE, JORGENSEN.....	53	FRANCIS AGO PER CORPI ESTRANEI.....	374

FRANKLIN-SILVERMANN AGO PER BIOPSIA	206
FRAZIER DIVARICATORE ADDOMINALE	181
FRAZIER DURA DISSETTORE	333
FRAZIER UNCINO PER LA PELLE	149
FREEMAN DIVARICATORE PER CHIRURGIA PLASTICA	198
FREEMAN FACE LIFT FORBICI	74
FREER COLTELLO PER SETTO NASALE	434
FREER ELEVATORE	434
FREER ELEVATORE PER SETTO	437
FREER SCALPELLO PER SETTO	437
FREER UNCINO PER LA PELLE	448
FRENZEL ABBASSALINGUA	451
FRENZEL OCCHIALI NISTAGMO	20
FRIEDMANN MINI PINZA SGORBIA	234
FRIEDMANN SPECOLO VAGINALE	577
FRI TSCH DIVARICATORE	163
FRYKHOLM PINZA SGORBIA	240
FUCHS PINZA CAPSULARE	391
FUCHSIG PINZA EMOSTATICA	113
G	
GALLAHER RASPA NASALE	446
GASS UNCINO	376
GAUSS PINZA PER IL CUOIO CAPELLUTO	605
GELPI DIVARICATORE ADDOMINALE	189/1
GELPI DIVARICATORE ADDOMINALE	189/2
GEMINI PINZA EMOSTATICA	115
GERALD PINZA ANATOMICA	86
GERALD PINZA CHIRURGICA	87
GERSTER PINZA PER OSSA	250
GERZOG MARTELLO	270
GHIGLIOTTINA PER TAGLIARE FILI 32CM	320
GIERTZ-STILLE COSTOTOMO	481
GIGLI SEGA	332
GILL DISSETTORE CORNEALE	373
GILL PINZA PER IRIDE	384
GILL-ARRUGA PINZA CAPSULARE	390
GILL-HESS PINZA PER IRIDE	384
GILLIES PINZA CHIRURGICA	86
GILLIES PORT'AGHI	212
GILLIES UNCINO PER LA PELLE	448
GIL-VERNET DIVARICATORE	152
GIUNTO DI PROLUNGAMENTO	299
GLOVER BULLDOG PINZA ATRAUMATICA	100
GLOVER BULLDOG PINZA ATRAUMATICA	103
GLOVER PINZA VASCOLARE	515
GLUCK COSTOTOMO	480
GOELET DIVARICATORE	141
GOLDMANN-FOX FORBICI GINGIVALI	67
GOMEL MICRO FORBICI	80
GOMEL MICROPINZA CHIRURGICA	96
GONIOMETRO PER LE DITA	25
GONIOMETRO, MOELTGEN	25
GOOD FORBICI PER TONSILLE	59
GOODELL DILATATORE UTERINO	581
GORNEY DISSETTORE	277
GORNEY FACE LIFT FORBICI	73
GOSSET DIVARICATORE ADDOMINALE	181
GOURDET CUCCHIAIO UTERINO	599
GRADLE FORBICI PER OFTALMOLOGIA	57
GRADLE PINZA DEPILETORIA	395
GRAEFFE BLEFAROSTATO	370
GRAEFFE CISTOTOMO	375
GRAEFFE COLTELLO LANCEOLARE	372
GRAEFFE COLTELLO LANCEOLARE	372
GRAEFFE COLTELLO PER CATARATTA	371
GRAEFFE CUCCHIAIO PER CATERATTA	377
GRAEFFE FORBICI	56
GRAEFFE PINZA DA PRESA	83
GRAEFFE PINZA FISSATRICE	389
GRAEFFE PINZA PER IRIDE	382
GRAEFFE UNCINO	149
GRAEFFE UNCINO PER IL STRABISMO	375
GRAFFA PER IL CUOIO CAPELLUTO, RANEY	327
GRAHAM UNCINO PER NERVI	329
GRAIG PINZA NASALE	426
GRAVE SPECOLO VAGINALE	570
GRAY PINZA EMOSTATICA	121
GREEN DISSETTORE CORNEALE	374
GREEN DIVARICATORE	160
GREEN PINZA FISSATRICE	390
GREEN UNCINO PER IL STRABISMO	375
GREEN-ARMYTAGE PINZA UTERINA PER EMOSTASI	605
GREGORY PINZA CARDIOVASCOLARE ATRAUMATICA	517
GREVEN MIKRO-PINZA AURICOLARE	414
GROSS CUCCHIAIO AURICOLARE	409
GROSS-MAIER PINZA PER MEDICATURA	134
GRUBER SPECOLO AURICOLARE	399
GUAINA PER VITI	325
GUIDA CONDUTTRICE	321
GUIDA TENDINI, BUNELL	294
GUILDEN CANNULA PER ASPIRAZIONE	433/1
GUTHRIE UNCINO PER LA PELLE	149
GUYON CANDELETTA DILATRICE	554
GUYON INTRODUTTORE PER CATETERI	554
GUYON PINZA EMOSTATICA	122
GUYON PINZA RENALE	122
GUYTON-LUNDGAARD SCLEROTOMO	373
H	
HABERER SPATOLA ADDOMINALE E INTESTINALE	143/1
HAGLUND-STILLE DIVARICATORE PER GESSI	232
HAIGHT DIVARICATORE COSTALE	487
HAJEK MARTELLO	273
HAJEK SCALPELLO PER SETTO	442/1
HAJEK-BALLENGER ELEVATORE PER SETTO	439
HAJEK-KOFLER PINZA SFENOIDALE	430, 431
HALLE CURETTA TAGLIANTE	253
HALLE ELEVATORE PER SETTO	437
HALSEY PORT'AGHI	208
HALSTED-MOSQUITO PINZA EMOSTATICA	105
HANK DILATATORE UTERINO	580
HARGIS ELEVATORE PER PERIOSTIO	463/2
HARGIS SEPERATORE PER IL CORPO	463/6
MANDIBOLARE	463/6
HARKEN PINZA AURICOLA	503
HARMS, SONDA	381
HARRINGTON DIVARICATORE	147
HARRINGTON PINZA PER BRONCHI	490
HARRINGTON-PEMBERTON DIVARICATORE	147
HARTMANN ABBASSALINGUA	452
HARTMANN CANNULA PER IRRIGAZIONE	433
HARTMANN CATETERE AURICOLARE	408
HARTMANN DIAPASON	403
HARTMANN PINZA PER CORPI ESTRANEI	412
HARTMANN PINZA EMOSTATICA	104
HARTMANN PINZA PER POLIPI	424
HARTMANN SPECOLO AURICOLARE	399
HARTMANN SPECOLO NASALE	422
HARTMANN-HALLE SPECOLO NASALE	421
HARTMANN-HOFFMANN PINZA PER CORPI	412
ESTRANEI	412
HARTMANN-WULLSTEIN PINZA PER CORPI	412
ESTRANEI	412
HAUGH MIKRO-PINZA AURICOLARE	414
HAYES PINZA PER ANASTOMOSI DEL RETTO	545
HEANEY PINZA PER ISTERECTOMIA	126
HEANEY PORT'AGHI	210
HEANY CURETTA PER BIOPSIA	587
HEANY DIVARICATORE	164
HEANY-BALLENTINE PINZA PER ISTERECTOMIA	127
HEATH FORBICI PER LEGATURE	66
HEATH MARTELLO	273
HEBRA CURETTA DA CALAZIO	377
HEGAR DILATATORE UTERINO	578, 579
HEGENBARTH PINZA PER AGRAFES	224
HEIFETZ SPATOLA CEREBRALE	369
HEIMING PINZA PER CALCOLI RENALI	536
HEISS PINZA EMOSTATICA	112
HEISTER APRIBOCCA	454
HENKE ELEVATORE PER TONSILLE	465
HENLEY DIVARICATORE	170
HENNIG DIVARICATORE PER GESSI	232
HEPP-SCHEIDEL MICRO FORBICI	78
HERRICK PINZA PER PEDUNCOLO RENALE	123
HESS PINZA CAPSULARE	391
HESS PINZA PER IRIDE	384
HESS UNCION PER NERVI	329/1
HEYMANN PINZA PER SETTO NASALE	425
HEYMANN FORBICI NASALI	58
HEYMANN-KNIGHT PINZA AURICOLARE	425
HEYWOOD-SMITH PINZA PER EMORROIDI	567
HIBBS OSTEOTOMO	265
HIBBS DIVARICATORE	164
HIBBS SCALPELLO	265
HIBBS SGORBIA	265
HILL-FERGUSON SPECOLO RETTALE	560
HIRSCHMAN SPATOLA PER CICLODIALISI	379
HIRSCHMANN ANOSCOPO	562
HOEN DURA DISSETTORE	333
HOESEL PORT'AGHI	213
HOESEL PORT'AGHI	213
HOEFER DIVARICATORE	465
HOFFMANN PINZA SERRATUBI	624
HOHMANN MINI ELEVATORE PER OSSA	286
HOLINGER LARINGOSCOPIO PER OPERAZIONE	37
HOLLINGER PORTATORE DI LUCE	37
HOLSHER UNCINO PER RADICI DEI NERVI	329/1
HOLTH PINZA TAGLIANTE PER CAPSULA	380
HOLZBACH PINZA PER ISTERECTOMIA	126
HOLZBACH PINZA PER ISTERECTOMIA	126
HOLZHEIMER DIVARICATORE	168
HOPKINS COLTELLO PER GESSI	233
HORGAN DIVARICATORE ADDOMINALE	183
HORIZON PINZA APPLICATORE CLIPS	524, 525
HORSLEY DURA DISSETTORE	333
HÖSEL DIVARICATORE	167
HOUSE CANNULA D'ASPIRAZIONE	337/2
HOUSE CURETTA	420
HOWARTH ELEVATORE PER SETTO	438
HUBER MANICO UNIVERSALE	472
HUDSON MANICO A T	300
HUDSON PERFORATORE A MANO	299
HULKA PINZA PER ABBASSARE IL COLLO	583
DELL'UTERO	583
HUMBY DERMATOMO	50
HUNTER PINZA PER SCHEGGE	91
HURD DISSETTORE PER TONSILLE	465
I	
I.U.D. PINZA DA PRESA FLESSIBILE, SERPENTINE	593
I.U.D. UNCINO ESTRATTORE	593
IMPATTATORE	322
IMPATTATORE / ESTRATTORE	322
IMPATTATORE FINALE, KUENTSCHER	321
INGE DIVARICATORE PER CORPI VERTEBRALI	339
INSERTO, BARACANI	472
INSERTO, BRUENINGS	472
INSERTO, CÖRDES	472
INSERTO, FRAENKEL	472
INSERTO, FRAENKEL	472
INSERTO, KRAUSE	472
INSERTO, LANGE	472
INSERTO, SCHEINMANN	472
INSERTO, SCHUMACHER	472
INSERTO, SEIFERT	472
INSOFFIATORE D'ARIA, POLITZER	406
INSOFFIATORE PER POLVERE, KABIERSKE	405
INSTRU-CARE OLIO PER STRUMENTI	634

INTRODUTTORE PER CATETERI GUYON	554	KEINSASSER LARINGOSCOPIO PER OPERAZIONE	35	KOGAN ENDOSPECOLO	577
IOWA AGO DI GUIDA.....	206	KEITH AGO.....	223	KÖNIG DIVARICATORE.....	153
IOWA PINZA PER ABBASSARE IL COLLO DELL'UTERO	584	KELLY DIVARICATORE.....	164	KÖNIG ELEVATORE PER OSSA	284
IRIS FORBICI	54	KELLY FORBICI VASCOLARI	61	KÖNIG PERIOTOTOMO	276
IRIS FORBICI, KNAPP.....	55	KELLY GRIP DIVARICATORE	142	KÖNIG SPECILLO DI GUIDA SCANALATO	221
IRIS FORBICI, LITTLER.....	55	KELLY PINZA EMOSTATICA	106	KOOS COLTELLO PER DURA MADRE	335
IRIS SUPERCUT FORBICI	72	KELLY PINZA PER POLIPI UTERINI	585	KÖRTE SPATOLA ADDOMINALE ED INTESTINALE	143/1
ISRAEL DIVARICATORE.....	162	KELLY PROCTOSCOPIO	562, 563	KRAUSE INSERTO	472
ISTEROMETRO VALLEIX	586	KELLY-RANKIN PINZA EMOSTATICA	106	KRAUSE SERRANODI.....	411
ISTEROMETRO, COLLIN	586	KERN TENAGLIA PER OSSA	244	KRAUSE SERRANODI	433/2
ISTEROMETRO, MARTIN.....	586	KERRISON PINZA TAGLIENTE NASALE	428	KRAUSE-VOSS SERRANODI	433/2
ISTEROMETRO, SIMS.....	586	KEVORKIAN CURETTA PER BIOPSIA	587	KRAYENBÜHL UNCINO PER NERVI	336
ISTEROMETRO, SIMS.....	586	KEVORKIAN PINZA PER BIOPSIA	589	KRISTELLER SPECOLO VAGINALE	572
ITERSON DIVARICATORE TRACHEALE	477	KEVORKIAN-PACIFIC PINZA PER BIOPSIA.....	592	KROENIG ABBASSALINGUA	451
IVES-FANSLER ANOSCOPIO	562, 563	KEY ELEVATORE.....	282	KRONECKER AGO PER LEGATURE	219
IWANSON COMPASSO.....	624	KEYES TREFINA CUTANEA	608	KUGLEN UNCINO	376
J		KIELLAND FORCIPE	602	KUHNT RASCHIATOIO CORNEALE	373
JACKSON BURROWS DIVARICATORE ADDOMINALE	189/2	KIELLAND-LUIKART FORCIPE	603	KÜMMEL SPATOLA ADDOMINALE	144
JACKSON DIVARICATORE TRACHEALE.....	476	KILLIAN PER IRRIGAZIONE	433, 433/1	KÜMMEL SPATOLA ADDOMINALE E INTESTINALE	143/2
JACKSON LARINGOSCOPIO PER OPERAZIONE	37	KILLIAN CANNULA PER IRRIGAZIONE	433, 433/1	KÜNTSCHER ALESATORE PER FEMORE	321
JACKSON PINZA PER AFFERRARE TENDINI DA PRESA	292	KILLIAN FORBICE PER IL SETTO NASALE	471	KÜNTSCHER ALESATORE PER L'APERTURA DEL MIDOLLO	321
JACKSON PINZA PER POLIPI LARINGEI.....	471	KILLIAN SGORBIA	442/1	KÜNTSCHER ESTRATTATORE	322
JACKSON SPECOLO VAGINALE	573	KILLIAN SPECOLO NASALE.....	423	KÜNTSCHER IMPATTATORE FINALE	321
JACOBS PINZA PER ABBASSARE IL COLLO DELL'UTERO	583	KILLIAN-CLAUS SGORBIA PER SETTO	442/1	L	
JACOBSON CURETTA TAGLIENTE	257	KILNER FORBICI PER CHIRURGIA	54	LA FORCE AGO PER CORPI ESTRANEI.....	374
JACOBSON PINZA EMOSTATICA	105	KILNER PORT'AGHI.....	212	LA FORCE COLTELLO ADENOIDE	450
JACOBSON PORT'AGHI	215	KILNER SUPERCUT FORBICI	72	LA FORCE COLTELLO ADENOIDE	450
JACOBSON SONDIA BOTTUNUTA	335	KILNER UNCINO NASALE	447/1	LA GRANGE FORBICI GINGIVALI	69
JACOBSON UNCINO PER DURA MADRE	335	KILNER UNCINO PER LA PELLE	608	LABORDE DILATATORE TRACHEALE	476
JAEGER COLTELLO LANCEOLARE	372	KILNER-DOUGHTY APRIBOCCA	456	LACRIMAL CANNULA OCULISTICA	394
JAEGER PLACCA PER PALPEBRE	371	KIRBY-ARTHUR PINZA PER IRIDE	385	LAHEY DIVARICATORE.....	157
JAMESON PINZA PER STRABISMO	385	KIRK MARTELLO	270	LAHEY PINZA EMOSTATICA	119/2
JAMESON UNCINO PER IL STRABISMO	375	KIRSCHNER ARCO PER ESTENSIONE	312	LAHEY PINZA PER GOZZO	479
JANSEN CURETTA TAGLIENTE.....	257	KIRSCHNER DIVARICATORE ADDOMINALE	185	LAHEY UNCINO ACUTO	149
JANSEN DIVARICATORE	168	KIRSCHNER DIVARICATORE ADDOMINALE	187	LAMA DI RASOIO	45
JANSEN PINZA AURICOLARE	424	KIRSCHNER DIVARICATORE ADDOMINALE COMPLETO.....	187/1	LAMA DI RICAMBIO.....	49
JANSEN PINZA SGORBIA.....	237	KIRSCHNER PERFORATORE A MANO	299	LAMA DI RICAMBIO, STERILE	50
JARCHO PINZA PER ABBASSARE IL COLLO DELL'UTERO	583	KIRSCHNER PERFORATORI FILIFORME	306, 307	LAMA PER OSTEOTOMI.....	266
JAVID PINZA PER CAROTIDE	511	KIRSCHNER SPECILLO DI GUIDA SCANALATO	221	LAMA PER SCALPELLI	266
JENNINGS APRIBOCCA	454	KIRSCHNER US ARCO PER ESTENSIONE	312	LAMBERT PINZA PER CALAZIO	393
JENSEN CANNULA OCULISTICA	394	KIRSCHNER TELAIO PIEGABILE	187	LAMBERT-KAY PINZA PER ANASTOMOSI	505
JOBSON-HORNE PORTACOTONE	203	KIT PER AUTOPSIA IN ASTUCCIO DI LEGNO.....	269	LAMBERT-LOWMAN PINZA PER OSSA	249
JOHNS-HOPKINS BULLDOG PINZA	104	KLAPP DIVARICATORE.....	150	LAMBOTTE OSTEOTOMO	261
JOHNS-HOPKINS PINZA APPLICATRICE	104	KLEINERT-KUTZ PINZA PER AFFERRARE TENDINI	294	LAMBOTTE TENAGLIA PER OSSA	244
JOHNS-HOPKINS PINZA EMOSTATICA.....	120	KLEINERT-KUTZ PINZA SGORBIA	237	LAME PER BISTURI, STERILI	42
JOHNSON PORT'AGHI	211	KLEINERT-KUTZ UNCINO PER LA PELLE	149	LAME PER BISTURI, STERILI	42
JONES PINZA FISSATELI	132	KLEINSASSER BRACCIO PORTALARINGOSCOPIO STERNALE	36	LAMPADA FRONTALE, CLAR	22
JORGENSEN FORBICI PER DISSEZIONE	53	KLEINSASSER CANNULA DA INIEZIONE	36	LANCASTER BLEFAROSTATO	371
JOSEPH (LEWIS) RASPA NASALE	443	KLEINSASSER CANNULA D'ASPIRAZIONE	36	LANDAU SPECOLO VAGINALE.....	577
JOSEPH COLTELLO NASALE	434	KLEINSASSER PORTATORE DI LUCE FREDDA A FIBRE DI VETRO	36	LANDOLT PINZA DA PRESA PER TUMORI	341
JOSEPH ELEVATORE PER SETTO	437	KLEINSCHMIDT PINZA PER APPENDICE	544	LANE CACCIAVITE	323, 324
JOSEPH FORBICI PER CHIRURGIA	54	KLINKENBERGH-LOTH	65/2	LANE ELEVATORE PER OSSA	290
JOSEPH PERIOTOTOMO	277	KNAPP COLTELLO PER IRIDE	372	LANE PIEGAPLACCHE	325
JOSEPH RASPA NASALE	443	KNAPP COLTELLO PER IRIDE	372	LANE PINZA CHIRURGICA	84
JOSEPH SEGA NASALE	446	KNAPP CUCCHIAIO PER CATERATTA	378	LANE PINZA FISSATELI	133
JOSEPH UNCINO PER LA PELLE	149	KNAPP IRIS FORBICI	55	LANE PINZA PORTAPLACCHE	325
JUDD-ALLIS PINZA PER AFFERRARE INTESTINI	538	KNAPP UNCINO DIVARICATORE	375	LANE PINZA PORTAVITI	325
JUDD-MASSON DIVARICATORE VESCICALE	552	KNAPP-LUER PINZA PER TRACOMA	393	LANE PINZA STOMACALE	547
JUERS MIKRO-PINZA AURICOLARE.....	414	KNIGHT PINZA PER SETTO NASALE	425	LANE TENAGLIA PER OSSA	244
JURASZ PINZA PER POLIPI LARINGEI	471	KNOWLES FORBICI PER BENDAGGI	70	LANE TRETOWAN ELEVATORE PER OSSA	290
K		KOCHER DIVARICATORE	155	LANG DISSETTORE PER SACCO LACRIMALE	378
KABIERSKE INSOFFIATORE PER POLVERE	405	KOCHER DIVARICATORE	159	LANGE INSERTO	472
KADER SPATOLA ADDOMINALE ED INTESTINALE	143/1	KOCHER DIVARICATORE	160	LANGE UNCINO PER LE PINNE NASALI	448
KALLMORGEN SPECOLO VAGINALE	573	KOCHER DIVARICATORE	163	LANGE-HOHMANN ELEVATORE PER OSSA	286
KALT PINZA CAPSULARE	391	KOCHER DIVARICATORE	163	LANGENBECK ANSA AURICOLARE	409
KALT, PORT'AGHI	214	KOCHER PINZA EMOSTATICA	108	LANGENBECK COLTELLO PER AMPUTAZIONE	44
KALT-ARRUGA PORT'AGHI	214	KOCHER PINZA INTESTINALE	540	LANGENBECK COLTELLO PER CARTILAGINI	47
KANE PINZA OMBELICALE	605	KOCHER SONDIA PER GOZZO	479	LANGENBECK DIVARICATORE	158
KANTROWITZ PINZA EMOSTATICA	119/1	KOCHER SPATOLA VESCICALE	552	LANGENBECK DIVARICATORE	159
KAYE FACE LIFT FORBICI	73	KOCHER-LANGENBECK DIVARICATORE	159	LANGENBECK PERIOTOTOMO	275
		KOENIG AGO	223	LANGENBECK PORT'AGHI	213
		KOERTE DIVARICATORE	162	LANGENBECK SEGA PER DITA	296

LANGENBECK TENAGLIA PER OSSA	243	LOWMAN-HOGLUND PINZA PER OSSA	249	MATHIEU PINZA PER CORPI ESTRANEI	553/1
LANGENBECK-GREEN DIVARICATORE	153	LUBET-BARBON PINZA NASALE PER TAMPONI	424	MATHIEU PORT'AGHI	213
LARINGOSCOPIO MC INTOSH	29	LUC PINZA PER SETTO NASALE	426	MATHIEU SPECOLO RETTALE	560
LARINGOSCOPIO MILLER	30	LUCAE AGO PER PARACENTESI	408	MATHIEU-OLSEN PORT'AGHI	212
LARINGOSCOPIO PER OPERAZIONE KLEINSASSER	35	LUCAE DIAPASON	404	MATSON PERIOSTOTOMO	279
LARINGOSCOPIO FOREGGER	29	LUCAE MARTELLO	271	MATSON-ALEXANDER PERIOSTOTOMO	279
LARSEN PINZA PER AFFERRARE TENDINI	292	LUCAE PINZA AURICOLARE	410	MAUNDER APRIBOCCA DI LEGNO	459
LAWRENCE PINZA EMOSTATICA	119	LUCAE UNCINO	409	MAXI GRASPER PINZA PER BIOPSIA	593
LEBSCHÉ SCALPELLO PER STERNO	267	LUER CANNULA TRACHEALE	479	MAYFIELD PINZA SGORBIA	238
LEES PINZA PER BRONCHI	504	LUER DIVARICATORE	140	MAYO ABBASSALINGUA	451
LEGATORE EMORROIDALE, MC GIVNEY	568	LUER PINZA SGORBIA	236	MAYO CUCCHIAIO PER CALCOLI BILIARI	534
LEGATORE EMORROIDALE, RUDD	568	LUER-KOERTE CUCCHIAIO PER CALCOLI BILIARI	533	MAYO FORBICI PER DISSEZIONE	52
LEGUE DIVARICATORE VESCICALE	553	LUIKART FORCIPE	603	MAYO PINZA	89
LEGUEU SPATOLA VESCICALE	552	LUIKART-BILL TRATTORE	604	MAYO SONDA PER CALCOLI BILIARI	534
LEKSELL(STILLE) PINZA SGORBIA	240	LUNDSGAARD SCLEROTOMO	373	MAYO SPILLONE PER STERILIZZAZIONE	227
LELAND-JONES PINZA VASCOLARE	494	LUNIATSCHKEK TAMPONATORE	465	MAYO SUPERCUT FORBICI	71
LEMPERT CURETTA TAGLIENTE	256			MAYO-ADAMS DIVARICATORE	171
LEMPERT ELEVATORE	420	M		MAYO-BLAKE PINZA PER CALCOLI BILIARI	531
LEMPERT PINZA SGORBIA	237	MAGIL PINZA PER INTRODUZIONE SONDE	28	MAYO-COLLINS DIVARICATORE	141
LERCHE PINZA DA PRESA	83	MAGLIA METALLICA PER ESTENSIONE	311	MAYO-COLLINS DIVARICATORE-SET	141
LERICHE PINZA EMOSTATICA	111	MALTZ (COTTLE) RASPA NASALE	444	MAYO-HABERISSER PINZA TORCIFILI	319
LERICHE SPATOLA ADDOMINALE E INTESTINALE	143/2	MALTZ RASPA NASALE	443	MAYO-HEGAR PORT'AGHI	209
LESINA	304	MANICI PER LAMA BISTURI	38	MAYON-GUYON PINZA EMOSTATICA	122
LESINA, PERTHES	304	MANICI PER LAMA BISTURI	39	MAYO-NOBLE FORBICI PER DISSEZIONE	52
LESTER PINZA FISSATRICE	389	MANICI PER LAMA BISTURI	39/1	MAYO-ROBSON PINZA INTESTINALE	541
LEVA PER CORPI ESTRANEI, BUCK	412	MANICI PER LAMA BISTURI	39/2	MAYO-STILLE FORBICI PER DISSEZIONE	52
LEVA PER CORPI ESTRANEI, QUIRE	412	MANICI PER LAMA BISTURI	40	MAYO-STILLE SUPERCUT FORBICI	71
LEVA PIEGAPLACCHE, LANE	325	MANICI PER LAMA BISTURI	41	MC DONALD ELEVATORE	283
LEVINSON AGO PER CORPI ESTRANEI	374	MANICO	266	MC INDOE CESOIA PER OSSA	241
LEWIN TENAGLIA PER OSSA	246	MANICO	266	MC INTOSH LARINGOSCOPIO	29
LEXER BABY FORBICI PER DISSEZIONE	53	MANICO	300	MC INTOSH LARINGOSCOPIO SET	31
LEXER FORBICI PER DISSEZIONE	53	MANICO A BATTERIA PER LUCE CALDA	32	MC KENZIE PERFORATORE	299
LEXER MINI SGORBIA	263	MANICO A BATTERIA PER LUCE CALDA	34	MCCULLOUGH PINZA PER STRABISMO	385
LEXER OSTEOTOMO	263	MANICO A BATTERIA PER LUCE FREDDA	33	MCGEE MIKRO-PINZA AURICOLARE	414
LEYLA SISTEMA DI FISSAGGIO	368, 368/1, 368/2, 368/3, 368/4	MANICO A T, HUDSON	300	MCGEE UNCINO	419
LICHTENBERG PORT'AGHI	213	MANICO CON ATTACCO RAPIDO	301	MCGIVNEY LEGATORE EMORROIDALE	568
LICHTWITZ CANNULA	433	MANICO D'ASPIRAZIONE WULLSTEIN	338	MCGIVNEY PINZA EMORROIDALE	568
LICHTWITZ TREQUARTO PER SENO MASCELLARE	204	MANICO PER STRUMENTI MICROLARINGEI	475	MCINDOE FORBICI PER CARTILAGINE	65/1
LIEBERMANN BLEFAROSTATO	371	MANICO UNIVERSALE, HUBER	472	MCINDOE PINZA CHIRURGICA	85
LIMA PER OSSA	294	MANO DI PIOMBO	250	MCINTYRE CANNULA OCULISTICA	394
LIMA PER OSSA	612/1	MARCATORE, CONNIN-AMSLER	380	MCIVOR APRIBOCCA	457
LIMETTA PER LE UNGHIE	610	MARQUARDT PINZA SGORBIA	239	MCKENZIE ELEVATORE PER SETTO	437
LISTER FORBICI PER BENDAGGI	69/1	MARSCHIK PINZA PER TONSILLE	468	MCKENZIE PINZA POSA CLIPS	326
LISTER SUPERCUT FORBICI	72	MARTEL PINZA DA PRESA	110	MCLEAN FORCIPE	603
LISTER(SINUS) TUPFERZA	137	MARTELLO DI PERCUSSIONE, BABINSKY	24	MCLEAN-LUIKART FORCIPE	603
LISTER-BURCH BLEFAROSTATO	370	MARTELLO DI PERCUSSIONE, BERLINER	24	MCLEAN-TUCKER-LUIKART FORCIPE	603
LISTON CESOIA PER OSSA	241	MARTELLO DI PERCUSSIONE, BUCK	24	MCPHERSON PINZA PER FILO	392
LISTON COLTELLO PER AMPUTAZIONE	44	MARTELLO DI PERCUSSIONE, TAYLOR	24	MEAD MARTELLO	271
LITTAUER FORBICI PER LEGATURE	66	MARTELLO DI PERCUSSIONE, TROEMNER	24	MEAD PINZA SGORBIA	235
LITTAUER PINZA AURICOLARE	411	MARTELLO IN PLASTICA	271	MEEKER PINZA EMOSTATICA	119
LITTAUER PINZA DEPIILATORIA	395	MARTELLO, BERGMANN	272	MEHDORN CLIPS PER VASI	362
LITTAUER PINZA PER POLIPI	425	MARTELLO, COLLIN	270	MEHDORN PINZA POSA CLIPS	362
LITTLE DIVARICATORE	157	MARTELLO, COTTLE	273	MELLINGER BLEFAROSTATO	370
LITTLER IRIS FORBICI	55	MARTELLO, COTTLE	273	MELLINGER-AXENFELD BLEFAROSTATO	370
LITTLEWOOD PINZA PER AFFERRARE INTESTINI	538	MARTELLO, GERZOG	270	MENGHINI AGO PER BIOPSIA	206
LOCKHART-MUMMERY SPECILLO PER FISTOLE	200	MARTELLO, HAJEK	273	MERCEDES DIVARICATORE PER TORACE	489
LOCKLIN FORBICE GINGIVALI	69	MARTELLO, HEATH	273	MERIAM PINZA DENTALE	93
LOCKWOOD-ALLIS PINZA PER AFFERRARE INTESTINI	538	MARTELLO, KIRK	270	METZENBAUM FINO TC FORBICI PER DISSEZIONE	53/1
LONDON-COLLEGE PINZA DENTALE	93	MARTELLO, LUCAE	271	METZENBAUM FORBICI PER CHIRURGIA	54
LOPEZ-REINKE DISSETTORE PER TONSILLE	465	MARTELLO, MEAD	271	METZENBAUM FORBICI PER DISSEZIONE	53/1
LORENZ FORBICI PER BENDAGGI	70	MARTELLO, OMBREDANNE	273	METZENBAUM PORT'AGHI	211
LORNA PINZA FISSATELI	133	MARTELLO, PARTSCH	271	METZENBAUM SUPER CUT FORBICI	71
LOUTE STRUMENTO TENDIFILI	315	MARTELLO, QUISLING	271	METZENBAUM TC FORBICI PER DISSEZIONE	53/1
LOVE DIVARICATORE	465	MARTELLO, WILLIGER	271	MEYERDING DIVARICATORE	157
LOVE UNCINO PER NERVI	329/2	MARTIN DIVARICATORE	175/1	MEYERDING DIVARICATORE	177
LOVE UNCINO PER RADICI DEI NERVI	330	MARTIN FORBICI PER CARTILAGINE	65/1	MEYERDING DIVARICATORE	180
LOVE-GRUENWALD PINZA TAGLIENTE PER LAMINECTOMIA	340	MARTIN ISTEROMETRO	586	MEYHOEFER CURETTA DA CALAZIO	377
LOVELACE PINZA EMOSTATICA	109	MARTIN PELVIMETRO	605	MICHEL AGRAFES	224
LOVELACE PINZA PER AFFERRARE IL POLMONE	490	MARTIN TENAGLIA PER OSSA	246	MICHEL PINZA PER AGRAFES	224
LOWER PINZA EMOSTATICA	120	MARTINI CURETTA TAGLIENTE	257	MICHEL SPECCHIO LARINGEO	423
LOWMAN PINZA PER OSSA	249	MASING-NEIVERT UNCINO NASALE	447/1	MICRO FORBICI	76
		MASSON PORT'AGHI	210	MICRO FORBICI	77
		MASTIN PINZA MUSCOLARE	479	MICRO FORBICI	78
		MATHIEU DIVARICATORE	141		

MICRO FORBICI AURICOLARI, BELLUCCI.....	413
MICRO FORBICI AURICOLARI, SHEA.....	413
MICRO FORBICI, GOMEL.....	80
MICRO FORBICI, HEPP-SCHUIDEL.....	78
MICRO FORBICINE, BELLUCCI.....	417
MICRO FRIEDMANN PINZA SGORBIA.....	234
MICRO PINZA AURICOLARE.....	415
MICRO PINZA AURICOLARE A CUCCHIAIO	
WULLSTEIN.....	416
MICRO-HARTMANN PINZA EMOSTATICA.....	104
MICROPINZA CHIRURGICA, GOMEL.....	96
MICROVASCULAR PORT'AGHI.....	210
MIDDELDORPF DIVARICATORE.....	160
MIDDLETON-JANSEN PINZA PER SETTO NASALE.....	430
MIKRO COLTELLO FALCATO.....	475
MIKRO SEPERATORE.....	475
MIKRO UNCINO.....	475
MIKRO-PINZA AURICOLARE.....	413
MIKRO-PINZA AURICOLARE, COS.....	414
MIKRO-PINZA AURICOLARE, DIETER.....	414
MIKRO-PINZA AURICOLARE, GREVEN.....	414
MIKRO-PINZA AURICOLARE, HAUGH.....	414
MIKRO-PINZA AURICOLARE, JUERS.....	414
MIKRO-PINZA AURICOLARE, MCGEE.....	414
MIKULICZ DIVARICATORE.....	163
MIKULICZ PINZA INTESTINALE.....	543
MIKULICZ PINZA PERITONEALE.....	123
MIKULICZ-BABY PINZA PERITONEALE.....	123
MILLER LARINGOSCOPIO.....	30
MILLER RASPA NASALE.....	444
MILLIGAN DURA DISSETTORE.....	332
MILLIN DIVARICATORE VESCICALE.....	552
MILLIN DIVARICATORE VESCICALE.....	553
MILLIN PINZA CAPSULARE DA PRESA.....	551
MILLIN PINZA DA PRESA PER LA PROSTATA.....	551
MINI MANICO CON ATTACCO RAPIDO.....	301
MINI-LAMBOTTE OSTEOTOMO.....	262
MINIMUS II, SFGIMOMANOMETRO.....	11
MINIMUS III, SFGIMOMANOMETRO.....	12
MIXTER PINZA CURVA AD "S".....	116
MIXTER PINZA PER CALCOLI BILIARI.....	531
MIXTER-BABY PINZA EMOSTATICA.....	119/1
MIXTER-O'SHAUGNESSY PINZA EMOSTATICA.....	119/2
MOD. BONN PINZA PER IRIDE.....	387
MOD. TÜBINGEN PINZA PER IRIDE.....	387
MOD.MÜNCHEN CURETTA PER BIOPSIA.....	587
MOD.VIENNA SPECOLO NASALE.....	421
MODELLATORE PER CHIODI, BENDER.....	322
MODELLO RUSSO, PINZA DA PRESA.....	85
MODELLO STRASSBURG PINZA CHIRURGICA.....	89
MOELTGEN GONIOMETRO.....	25
MOGEN STRUMENTO PER CIRCONCISIONE.....	556
MOLLISON DIVARICATORE.....	171
MOLT PERIOSTOTOMO.....	276
MONOPOLAR ELEKTRODEN ANSAN.....	628, 629
MOOR CUCCHIAIO PER CALCOLI BILIARI.....	532
MOORE PERFORATORE A MANO.....	298
MOORFIELD PINZA PER SUTURA.....	392
MORGAN PROCTOSCOPIO.....	565
MORITZ-SCHMIDT ABBASSALINGUA.....	452
MORRIS DIVARICATORE.....	164
MORRIS-DEBAKEY PINZA AORTA.....	506
MORSE DIVARICATORE COSTALE.....	484
MORSE-FAVALORO DIVARICATORE COSTALE.....	484
MORSETTO PER SISTEMA BRACCIO.....	189
MOYNIHAN PINZA EMOSTATICA.....	120
MOYNIHAN PINZA FISSATELI.....	133
MOYNIHAN SONDA PER CALCOLI BILIARI.....	532
MUELLER BLEFAROSTATO.....	371
MÜLLER CLIPS PER VASI.....	364,365
MURDOCK BLEFAROSTATO.....	370
MURPHY DIVARICATORE.....	156
MURPHY-LANE ELEVATORE.....	283
MUSEUM PINZA PER ABBASSARE IL COLLO	
DELL'UTERO.....	583
MYLES PINZA NASALE.....	427
N	
NABATOFF SET PER VARICI IN SCATOLA DI METALLO.....	201
NAEGELE FORCIPE.....	602
NAGER AGO PER TONSILLE.....	466
NAGER DIVARICATORE.....	465
NEFF COLTELLO PER MENISCO.....	292
NEGUS PINZA PER TONSILLE.....	467
NEGUS SUPPORTO PER PETTO.....	459
NEIVERT PORT'AGHI.....	208
NEIVERT-ANDERSON OSTEOTOMO NASALE.....	442
NELATON SPECILLO SCANALATO.....	199
NELSON AGO PER LEGATURE.....	219
NELSON STANDARD TREQUARTO.....	204
NELSON TREQUARTO.....	205
NEONATAL PINZA VASCOLARE CASTANEDA.....	527
NEWS DIVARICATORE TRACHEALE.....	477
NISSEN PINZA EMOSTATICA.....	113
NORFOLK-NORWICH DIVARICATORE.....	172
NORTHBENT FORBICI PER LEGATURE.....	66
NOTO PINZA PER POLIPI UTERINI.....	585
NOVA, SFGIMOMANOMETRO.....	6,7
NOVAK CURETTA PER BIOPSIA.....	587
NOYES FORBICI OCULISTICHE.....	75
NOYES PINZA PER POLIPI.....	425
O	
OBWEGESER AGO DI INTRODUZIONE.....	463
OBWEGESER AGO DI INTRODUZIONE.....	463/3
OBWEGESER DIVARICATORE.....	460, 461
OBWEGESER OSTEOTOMO A LAMA.....	464/1
OBWEGESER PERIOSTOTOMO.....	461, 462, 463
OCCIALI NISTAGMO FRENZEL.....	20
OCHSNER TREQUARTO.....	205
O'CONNOR UNCINO PER IRIDE.....	375
OEHLER PINZA CHIRURGICA.....	81/1
OLDBERG PINZA TAGLIANTE PER LAMINECTOMIA.....	341
OLIO PER STRUMENTI INSTRU CARE.....	634
OLIVA NASALE POLITZER.....	406
OLIVECRONA DURA DISSETTORE.....	332
OLIVECRONA PINZA SGORBIA.....	237
OLIVECRONA SEGA IN FILO D'ACCIAIO.....	332
OLIVECRONA SPATOLA CEREBRALE.....	336
OLIVECRONA-TOENNIS (SCOVILLE).....	326
OLIVECRONA-TOENNIS PINZA POSA CLIPS.....	326
OLLIER DIVARICATORE.....	162
OLSEN-HEGAR PORT'AGHI.....	212
OMBREDANNE MARTELLO.....	273
OSTEOTOME, COTTLE.....	440
OSTEOTOMI.....	259
OSTEOTOMI.....	464
OSTEOTOMI EPKER.....	464/2
OSTEOTOMO A LAMA OBWEGESER.....	464/1
OSTEOTOMO LEXER.....	263
OSTEOTOMO MINI-LAMBOTTE.....	262
OSTEOTOMO NASALE NEIVERT-ANDERSON.....	442
OSTEOTOMO PER SETTO, COTTLE.....	440
OSTEOTOMO PER SETTO, FOMON.....	441
OSTEOTOMO PER SETTO, SHEEHAN.....	441
OSTEOTOMO, HIBBS.....	265
OSTEOTOMO, LAMBOTTE.....	261
OSTEOTOMO, SMITH-PETERSEN.....	261
OSTEOTOMO, STILLE.....	260
OSTEOTOMO PER SETTO RUBIN.....	440
OSTROEM PINZA TAGLIANTE PER SETTO NASALE.....	430
OSTROEM PINZA TAGLIANTE PER SETTO NASALE.....	430
O'SULLIVAN-O'CONNOR DIVARICATORE	
ADDOMINALE.....	181
O'SULLIVAN-O'CONNOR DIVARICATORE	
ADDOMINALE.....	181
O'SULLIVAN-O'CONNOR SPECOLO VAGINALE.....	576
OTIS URETROTOMO.....	553
OVERHOLT PINZA EMOSTATICA.....	114
OVERHOLT-BABY PINZA EMOSTATICA.....	114
OVERHOLT-GEISENDORFER PINZA EMOSTATICA.....	114
OVERHOLT-MIXTER PINZA EMOSTATICA.....	115
P	
PADELLA.....	621
PARK BLEFAROSTATO.....	371
PARKER DIVARICATORE.....	139
PARTSCH MARTELLO.....	271
PARTSCH SCALPELLO.....	259
PARTSCH SGORBIA.....	259
PASSOW PESTELLO DA TAMPONARE.....	260
PATON DISETTORE CORNEALE.....	373
PAUFIQUE COLTELLO PER CHERATOPLASTICA.....	373
PAUFIQUE PINZA PER FILO.....	392
PAYR SCHIACCIATORE PER L'INTESTINO E LO	
STOMACO.....	548
PAYR SPECILLO DI GUIDA SCANALATO.....	221
PEAN PINZA DA PRESA.....	110
PEAN PINZA EMOSTATICA.....	108
PECK-JOSEPH FACE LIFT FORBICI.....	74
PECK-JOSEPH FACE LIFT FORBICI.....	74
PEDERSON SPECOLO VAGINALE.....	570
PEENFIELD DISSETTORE.....	333
PEERS PINZA FISSATELI.....	132
PEET PINZA PER SCHEGGE.....	92
PEET RASPA NASALE.....	446
PELKMANN PINZA PER MEDICATURA.....	137
PELVIMETRO, COLLIER.....	605
PELVIMETRO, COLLIN.....	605
PELVIMETRO, MARTIN.....	605
PENNINGTON ELEVATORE PER SETTO.....	438
PENNINGTON PINZA EMOSTATICA.....	109
PERCY RETRATTORE.....	296
PERFORATORE A MANO, BUNELL.....	299
PERFORATORE A MANO, HUDSON KPLT.....	299
PERFORATORE A MANO, KIRSCHNER.....	299
PERFORATORE A MANO, MOORE.....	298
PERFORATORE A MANO, RALK.....	300
PERFORATORE A MANO, STILLE.....	298
PERFORATORE A MANO, STILLE-SHERMAN.....	298
PERFORATORE ELICOIDALE.....	302
PERFORATORE INTRAMODIOLARE.....	322
PERFORATORE, CRUTCHFIELD.....	327
PERFORATORE, CUSHING.....	299
PERFORATORE, ERRICO.....	299
PERFORATORE, MC KENZIE.....	299
PERFORATORE, SMELLIE.....	607
PERFORATORI FILIFORME KIRSCHNER.....	306, 307
PERIOSTOTOMO.....	279
PERIOSTOTOMO MOLT.....	276
PERIOSTOTOMO SELDIN.....	277
PERIOSTOTOMO, ADSON.....	282
PERIOSTOTOMO, ALEXANDER.....	276
PERIOSTOTOMO, COBB.....	280
PERIOSTOTOMO, DINGMANN.....	463
PERIOSTOTOMO, DOYEN.....	278
PERIOSTOTOMO, FARABEUF.....	274
PERIOSTOTOMO, FARABEUF-COLLIN.....	274
PERIOSTOTOMO, FOMON.....	277
PERIOSTOTOMO, JOSEPH.....	277
PERIOSTOTOMO, KOENIG.....	276
PERIOSTOTOMO, LAMBOTTE.....	274
PERIOSTOTOMO, LANGENBECK.....	275
PERIOSTOTOMO, MATSON.....	279
PERIOSTOTOMO, MATSON-ALEXANDER.....	279
PERIOSTOTOMO, OBWEGESER.....	461, 462, 463
PERIOSTOTOMO, SEMB.....	278
PERIOSTOTOMO, WILLIGER.....	276
PERKINS DIVARICATORE.....	168

PERTHES LESINA.....	304	PINZA CHIRURGICA, ADSON-BROWN	82	PINZA EMOSTATICA, KELLY-RANKIN	106
PESTALOZZA CURETTA PER ABORTO	606	PINZA CHIRURGICA, BONNEY	88	PINZA EMOSTATICA, LAHEY	119/2
PESTELLO DA TAMPONARE, PASSOW	260	PINZA CHIRURGICA, BROPHY	84	PINZA EMOSTATICA, LAWRENCE	119
PETZ APPARECCHIATURA DI SUTURA		PINZA CHIRURGICA, CUSHING	83	PINZA EMOSTATICA, LERICHE	111
GASTRO-INTESTINALE	549	PINZA CHIRURGICA, FERRIS-SMITH.....	84	PINZA EMOSTATICA, LOVELACE.....	109
PHANEUF PINZA PERITONEALE	123	PINZA CHIRURGICA, GILLIES	86	PINZA EMOSTATICA, LOWER	120
PIERCE ELEVATORE PER SETTO	438	PINZA CHIRURGICA, LANE	84	PINZA EMOSTATICA, MAYO-GUYON	122
PIERCE TREQUARTO PER SENO MASCELLARE	204	PINZA CHIRURGICA, MCINDOE	85	PINZA EMOSTATICA, MEEKER	119
PIFFARD CURETTA PER LUPUS	608	PINZA CHIRURGICA, MOD.USA	81/1	PINZA EMOSTATICA, MICRO-HARTMANN.....	104
PILLING PINZA APPLICATORE CLIPS SMAL	524, 525	PINZA CHIRURGICA, OEHLER TC.....	81/1	PINZA EMOSTATICA, MIXTER	119/1
PINARD STETOSCOPIO	23	PINZA CHIRURGICA, SEMKEN	86	PINZA EMOSTATICA, MIXTER-BABY	119/1
PINZA PER CORPI ESTRANEI, HARTMANN	412	PINZA CHIRURGICA, STILLE	81/1	PINZA EMOSTATICA, MOYNIHAN.....	120
PINZA PER CORPI ESTRANEI,		PINZA CHIRURGICA, TAYLOR	87	PINZA EMOSTATICA, O'SHAUGNESSY	119/2
HARTMANN-HOFFMANN	412	PINZA COPERCHIO HADEO	615	PINZA EMOSTATICA, PENNINGTON.....	109
PINZA PER CORPI ESTRANEI,		PINZA CURVA AD "S" MIXTER.....	116	PINZA EMOSTATICA, PROVIDENCE-HOSPITAL.....	106
HARTMANN-WULLSTEIN	412	PINZA DA PRESA.....	316,317	PINZA EMOSTATICA, ROBERTS	117
PINZA VASCOLARE, WANGENSTEEN	89	PINZA DA PRESA COTTLE	410	PINZA EMOSTATICA, ROCHESTER-CARMALT	109
PINZA AD ASTA TUBOLARE PER MICROCHIRURGIA.....	474	PINZA DA PRESA PER FILI KIRSCHNER.....	305	PINZA EMOSTATICA, ROCHESTER-OCHSNER	108
PINZA ANATOMICA STANDARD	81	PINZA DA PRESA PER LA PROSTATA, MILLIN.....	551	PINZA EMOSTATICA, ROCHESTER-PEAN	108
PINZA ANATOMICA, ADSON.....	82	PINZA DA PRESA PER TONSILLE ABRAHAM.....	468	PINZA EMOSTATICA, RUMEL	117
PINZA ANATOMICA, ADSON MICRO.....	82	PINZA DA PRESA PER TUMORI, LANDOLT	341	PINZA EMOSTATICA, SAROT	118
PINZA ANATOMICA, BONNEY	88	PINZA DA PRESA, COLLIN-DUVAL.....	85	PINZA EMOSTATICA, SPENCER-WELLS	109
PINZA ANATOMICA, BONNEY	88	PINZA DA PRESA, DURANTE	88	PINZA EMOSTATICA, STILLE	122
PINZA ANATOMICA, BROPHY	84	PINZA DA PRESA, DUVAL	85	PINZA EMOSTATICA, TOENNIS.....	117
PINZA ANATOMICA, CUSHING	83	PINZA DA PRESA, GRAEFE	83	PINZA EMOSTATICA, ZENKER	118
PINZA ANATOMICA, GERALD	86	PINZA DA PRESA, LERCHE	83	PINZA EMOSTATICA, OVERHOLT-BABY	114
PINZA ANATOMICA, MCINDOE.....	85	PINZA DA PRESA, MARTEL	110	PINZA EMOSTATICA, OVERHOLT-GEISSDÖRFER.....	114
PINZA ANATOMICA, MOD.USA	81	PINZA DA PRESA, MODELLO RUSSO.....	85	PINZA EMOSTATICA, OVERHOLT-MIXTER	115
PINZA ANATOMICA, POTTS-SMITH	81	PINZA DA PRESA, PEAN.....	110	PINZA FISSATELI	133
PINZA ANATOMICA, SEMKEN	86	PINZA DA PRESA, PRATT.....	110	PINZA FISSATELI BALL AND SOCKET	133
PINZA ANATOMICA, STILLE	81	PINZA DA PRESA, WILLET MARTEL	110	PINZA FISSATELI, BACKHAUS	132
PINZA ANATOMICA, TAYLOR.....	87	PINZA DENTALE LONDON-COLLEGE	93	PINZA FISSATELI, BERNHARD	133
PINZA ANATOMICA, TC.....	81	PINZA DENTALE MERIAM	93	PINZA FISSATELI, DOYEN	133
PINZA ANEURISMA DEBAKEY-BAHNSON	506	PINZA DEPILATORIA BEER	395	PINZA FISSATELI, JONES	132
PINZA AORTA DIETRICH	510	PINZA DEPILATORIA, BARRAQUER	395	PINZA FISSATELI, LANE	133
PINZA AORTA MORRIS-DEBAKEY	506	PINZA DEPILATORIA, DOUGLAS	395	PINZA FISSATELI, LORNA	133
PINZA ATRAUMATICA BULLDOG, DE BAKEY	100	PINZA DEPILATORIA, GRADLE	395	PINZA FISSATELI, MOYNIHAN	133
PINZA ATRAUMATICA BULLDOG, GLOVER	100	PINZA DEPILATORIA, LITTAUER	395	PINZA FISSATELI, PEERS.....	132
PINZA ATRAUMATICA IN TITANIO, DEBAKEY	99	PINZA DEPILATORIA, HADEO	395	PINZA FISSATELI, ROEDER	132
PINZA ATRAUMATICA PER NEONATI E BAMBINI	523	PINZA EMORROIDALE FERGUSSON	109	PINZA FISSATELI, SCHAEDEL	132
PINZA ATRAUMATICA TC DEBAKEY	99	PINZA EMORROIDALE, MCGIVNEY	568	PINZA FISSATELI, TOHOKU	132
PINZA AURICOLARE, HARTMANN	411	PINZA EMOSTATICA BIRKETT	116	PINZA FISSATRICE, BARRAQUER	390
PINZA AURICOLARE, HEYMANN-KNIGHT.....	425	PINZA EMOSTATICA BRIDGE	116	PINZA FISSATRICE, CASTROVIEJO	390
PINZA AURICOLARE, JANSEN	424	PINZA EMOSTATICA COLLER-CRILE	106	PINZA FISSATRICE, ELSCHNIG	389
PINZA AURICOLARE, LITTAUER	411	PINZA EMOSTATICA DEBAKEY-MOSQUITO	509	PINZA FISSATRICE, GRAEFE	389
PINZA AURICOLARE, LUCAE	410	PINZA EMOSTATICA DEBAKEY-PEAN	513	PINZA FISSATRICE, GREEN	390
PINZA AURICOLARE, TILLEY	411	PINZA EMOSTATICA DEBAKEY-RANKIN	512	PINZA FISSATRICE, LESTER.....	389
PINZA AURICOLARE, TROELTSCH.....	424	PINZA EMOSTATICA FUCHSIG	113	PINZA INTESTINALE BRUNNER	543
PINZA AURICOLARE, WILDE (TROELTSCH).....	410	PINZA EMOSTATICA KANTROWITZ	119/1	PINZA INTESTINALE PER BIOPSIA, TURREL	567
PINZA AURICULA, HARKEN.....	503	PINZA EMOSTATICA KOCHER	108	PINZA INTESTINALE PER BIOPSIA, YEOMAN	566, 567
PINZA BIPOLARE.....	630, 631	PINZA EMOSTATICA NISSEN	113	PINZA INTESTINALE SCUDDER	541
PINZA BIPOLARE A BAIONETTA	631, 632	PINZA EMOSTATICA OVERHOLT	114	PINZA INTESTINALE, BABY-KOCHER	540
PINZA CAPSULARE DA PRESA, MILLIN.....	551	PINZA EMOSTATICA PEAN.....	108	PINZA INTESTINALE, DOYEN	540
PINZA CAPSULARE, ARRUGA	391	PINZA EMOSTATICA WIKSTROEM	117	PINZA INTESTINALE, FEHLAND	542
PINZA CAPSULARE, CASTROVIEJO	391	PINZA EMOSTATICA, ADSON	112	PINZA INTESTINALE, KOCHER.....	540
PINZA CAPSULARE, ELSCHNIG	391	PINZA EMOSTATICA, ADSON-BABY	113	PINZA INTESTINALE, MAYO-ROBSON	541
PINZA CAPSULARE, FUCHS.....	391	PINZA EMOSTATICA, BAINBRIDGE	119/2	PINZA INTESTINALE, MIKULICZ	543
PINZA CAPSULARE, GILL-ARRUGA	390	PINZA EMOSTATICA, BENGOLEA	112	PINZA INTESTINALE, RESANO	542
PINZA CAPSULARE, HESS	391	PINZA EMOSTATICA, CRAFOORD	118	PINZA INTESTINALE, STONE-WATT	545
PINZA CAPSULARE, KALT	391	PINZA EMOSTATICA, CRAFOORD-SELLORS.....	119	PINZA MAYO	89
PINZA CAPSULARE, SCHWEIGGER	391	PINZA EMOSTATICA, CRILE	107	PINZA MODELLO STRASSBURG	89
PINZA CAPSULARE, TERSON	391	PINZA EMOSTATICA, CRILE-RANKIN	107	PINZA MUSCOLARE, BERKE	389
PINZA CARDIOVASCOLARE ATRAUMATICA	526	PINZA EMOSTATICA, DANDY	109	PINZA MUSCOLARE, MASTIN	479
PINZA CARDIOVASCOLARE ATRAUMATICA COOLEY	518, 519, 522	PINZA EMOSTATICA, DESJARDINS	121	PINZA MUSCOLARE, PRINCE	387
PINZA CARDIOVASCOLARE ATRAUMATICA DERRA	515	PINZA EMOSTATICA, GEMINI	115	PINZA NASALE GRAIG	426
PINZA CARDIOVASCOLARE ATRAUMATICA GREGORY.....	517	PINZA EMOSTATICA, GRAY	121	PINZA NASALE PER TAMPONI LUBET-BARBON	424
PINZA CHIRURGICA GERALD.....	87	PINZA EMOSTATICA, GUYON	122	PINZA NASALE PER TAMPONI WESTMACOTT	424
PINZA CHIRURGICA POTTS SMITH	81	PINZA EMOSTATICA, HALSTED-MOSQUITO	105	PINZA NASALE WEIL-BLAKESLEY	426
PINZA CHIRURGICA STANDARD	81/1	PINZA EMOSTATICA, HARTMANN	104	PINZA NASALE, CAPLAN	428
PINZA CHIRURGICA WAUGH	83	PINZA EMOSTATICA, HEISS.....	112	PINZA NASALE, HARTMANN	427
PINZA CHIRURGICA, ADSON	82	PINZA EMOSTATICA, JACOBSON	105	PINZA NASALE, MYLES	427
PINZA CHIRURGICA, ADSON MICRO	82	PINZA EMOSTATICA, JOHNS-HOPKINS.....	120	PINZA NASALE, SCHMEDEEN	427
		PINZA EMOSTATICA, KELLY	106	PINZA NASALE, TAKAHASHI.....	427

PINZA NASALE, WATSON-WILLIAMS.....	428	PINZA PER AGRAFES, RICHTER-HEATH	224	PINZA PER IRIDE, GRAEFFE	382
PINZA NASALE, STRUYCKEN.....	427	PINZA PER ANASTOMOSI DEL RETTO, HAYES	545	PINZA PER IRIDE, HESS	384
PINZA OMBELICALE, COLLIN.....	605	PINZA PER ANASTOMOSI, BECK	516	PINZA PER IRIDE, KIRBY-ARTHUR.....	385
PINZA OMBELICALE, KANE.....	605	PINZA PER ANASTOMOSI, BECK	520	PINZA PER IRIDE, MOD. BONN.....	387
PINZA PER ABBASSARE IL COLLO DELL'UTERO CZERNY	584	PINZA PER ANASTOMOSI, COOLEY-DERRA	519	PINZA PER IRIDE, MOD. TUEBINGEN	387
PINZA PER ABBASSARE IL COLLO DELL'UTERO SCHRÖDER	583, 584	PINZA PER ANASTOMOSI, DE MARTEL-WOLFSON	546	PINZA PER IRIDE, TROUTMAN.....	389
PINZA PER ABBASSARE IL COLLO DELL'UTERO, BARRET.....	582	PINZA PER ANASTOMOSI, DEBAKEY	505	PINZA PER IRIDE, STEVENS	383
PINZA PER ABBASSARE IL COLLO DELL'UTERO, BRAUN	582	PINZA PER AORTA PEDIATRICA, SUBRAMANIAN-MINIATURE.....	521	PINZA PER ISTERECTOMIA SEGOND.....	125
PINZA PER ABBASSARE IL COLLO DELL'UTERO, DUPLAY	582	PINZA PER AORTA, WEBER.....	501	PINZA PER ISTERECTOMIA SEGOND-LANDAU	125
PINZA PER ABBASSARE IL COLLO DELL'UTERO, HULKA.....	583	PINZA PER APPENDICE, ALLEN.....	544	PINZA PER ISTERECTOMIA, WERTHEIM	126
PINZA PER ABBASSARE IL COLLO DELL'UTERO, IOWA	584	PINZA PER APPENDICE, KLEINSCHMIDT.....	544	PINZA PER ISTERECTOMIA, HEANY-BALLENTINE.....	127
PINZA PER ABBASSARE IL COLLO DELL'UTERO, JACOBS	583	PINZA PER BIOPSIA BABY BURKE	590	PINZA PER ISTERECTOMIA, ROGERS	127
PINZA PER ABBASSARE IL COLLO DELL'UTERO, JARCHO.....	583	PINZA PER BIOPSIA BABY TISCHLER	592	PINZA PER ISTERECTOMIA, WERTHEIM	124
PINZA PER ABBASSARE IL COLLO DELL'UTERO, MUSEUX.....	583	PINZA PER BIOPSIA SCHUMACHER	588, 589	PINZA PER ISTERECTOMIA, WERTHEIM	128
PINZA PER ABBASSARE IL COLLO DELL'UTERO, PRATT.....	584	PINZA PER BIOPSIA TOWNSEND.....	591	PINZA PER LACERAZIONE UNGHIE, RADOLF	297
PINZA PER ABBASSARE IL COLLO DELL'UTERO, SCHROEDER	583, 584	PINZA PER BIOPSIA, ALEXANDER.....	589	PINZA PER MEDICATURA	135
PINZA PER ABBASSARE IL COLLO DELL'UTERO, SCHROEDER (POZZI).....	582	PINZA PER BIOPSIA, BURKE	590	PINZA PER MEDICATURA, BRYANT.....	137
PINZA PER ABBASSARE IL COLLO DELL'UTERO, SKENE.....	582	PINZA PER BIOPSIA, EPPENDORFER.....	590	PINZA PER MEDICATURA, CHERON.....	137
PINZA PER ABBASSARE IL COLLO DELL'UTERO, TEALE.....	583	PINZA PER BIOPSIA, FAURE	588	PINZA PER MEDICATURA, COLLIN.....	137
PINZA PER ABBASSARE IL COLLO DELL'UTERO, STAUDE-MOORE	582	PINZA PER BIOPSIA, KEVORKIAN.....	589	PINZA PER MEDICATURA, DUPLAY	134
PINZA PER ABORTO, SAENGER	606	PINZA PER BIOPSIA, KEVORKIAN.....	591	PINZA PER MEDICATURA, FOERSTER.....	136
PINZA PER ABORTO, WINTER.....	606	PINZA PER BIOPSIA, MAXI GRASPER	593	PINZA PER MEDICATURA, GROSS-MAIER.....	134
PINZA PER AFFERRARE IL POLMONE, LOVELACE	490	PINZA PER BIOPSIA, SCHUBERT.....	588	PINZA PER MEDICATURA, LISTER (SINUS).....	137
PINZA PER AFFERRARE INTESTINI DOYEN-BABY	540	PINZA PER BIOPSIA, THOMAS-GAYLOR	588	PINZA PER MEDICATURA, PELKMANN.....	137
PINZA PER AFFERRARE INTESTINI		PINZA PER BIOPSIA, VAN DOREN.....	588	PINZA PER MEDICATURA, RAMPLEY	136
LOCKWOOD-ALLIS	538	PINZA PER BIOPSIA, WITTNER.....	589	PINZA PER MEDICATURA, SIMS-MAIER.....	134
PINZA PER AFFERRARE INTESTINI, ALLIS.....	537	PINZA PER BIOPSIA, TISCHLER.....	591	PINZA PER MEDICATURA, ULRICH	135
PINZA PER AFFERRARE INTESTINI, ALLIS-ADAIR.....	537	PINZA PER BIOPSIA, TISCHLER-KEVORK.....	592	PINZA PER MICROCHIRURGIA.....	94
PINZA PER AFFERRARE INTESTINI, ALLIS-BABY	537	PINZA PER BIOPSIA, TISCHLER-MORGAN	590, 591	PINZA PER OCCLUSIONE TANGENZIALE, DEBAKEY-SATINSKY	502
PINZA PER AFFERRARE INTESTINI, ATRAUMA.....	111	PINZA PER BIOPSIA, VAN DOREN.....	588	PINZA PER OSSA LAMBERT-LOWMAN.....	249
PINZA PER AFFERRARE INTESTINI, BABCOCK.....	539	PINZA PER BIOPSIA, WITTNER.....	589	PINZA PER OSSA, FELDHEIM.....	249
PINZA PER AFFERRARE INTESTINI, COLLIN.....	539	PINZA PER BIOPSIA, TISCHLER-MORGAN	590	PINZA PER OSSA, GERSTER.....	250
PINZA PER AFFERRARE INTESTINI, DUVAL.....	539	PINZA PER BRONCHI, FINOCCHIETTO.....	490	PINZA PER OSSA, LOWMAN.....	249
PINZA PER AFFERRARE INTESTINI, JUDD-ALLIS.....	538	PINZA PER BRONCHI, HARRINGTON.....	490	PINZA PER OSSA, LOWMAN-HOGLUND.....	249
PINZA PER AFFERRARE INTESTINI, LITTLEWOOD.....	538	PINZA PER BRONCHI, LEES	504	PINZA PER PATELLA.....	248
PINZA PER AFFERRARE INTESTINI, THOMS-ALLIS.....	538	PINZA PER BRONCHI, PRICE-THOMAS	490	PINZA PER PEDUNCOLO RENALE, HERRICK.....	123
PINZA PER AFFERRARE INTESTINI, WILLIAMS.....	539	PINZA PER BRONCHI, SEMB	491	PINZA PER PEDUNCOLO RENALE, WERTHEIM-CULLEN.....	125
PINZA PER AFFERRARE L'UTERO, COLLIN.....	585	PINZA PER BRONCO-ESOFAGOSCOPIA, CHEVALIER-JACK.....	473	PINZA PER PILORO, BENSON.....	544
PINZA PER AFFERRARE L'UTERO, COLLIGUES.....	585	PINZA PER CALAZIO, AYER.....	393	PINZA PER POLIPI LARINGEI FRAENKEL.....	471
PINZA PER AFFERRARE L'UTERO, SOMER.....	585	PINZA PER CALAZIO, DESMARRRES	393	PINZA PER POLIPI LARINGEI JURASZ.....	471
PINZA PER AFFERRARE TENDINI.....	293	PINZA PER CALAZIO, LAMBERT	393	PINZA PER POLIPI LARINGEI, JACKSON.....	471
PINZA PER AFFERRARE TENDINI JACKSON	292	PINZA PER CALCOLI BILIARI BLAKE	531	PINZA PER POLIPI UTERINI, DOYEN.....	585
PINZA PER AFFERRARE TENDINI KLEINERT-KUTZ.....	294	PINZA PER CALCOLI BILIARI DESJARDINS	531	PINZA PER POLIPI UTERINI, KELLY	585
PINZA PER AFFERRARE TENDINI, BRAND	293	PINZA PER CALCOLI BILIARI MAYO-BLAKE	531	PINZA PER POLIPI UTERINI, NOTO.....	585
PINZA PER AFFERRARE TENDINI, CAROLL.....	293	PINZA PER CALCOLI BILIARI MIXTER	531	PINZA PER POLIPI, HARTMANN.....	424
PINZA PER AFFERRARE TENDINI, LARSEN	292	PINZA PER CALCOLI RENALI, HEIMING.....	536	PINZA PER POLIPI, LITTAUER.....	425
PINZA PER AFFERRARE TENDINI, STEINMANN.....	292	PINZA PER CALCOLI RENALI, RANDALL.....	535	PINZA PER POLIPI, NOYES.....	425
PINZA PER AFFERRARE TESSUTI, BROWN.....	83	PINZA PER CAROTIDE JAVID	511	PINZA PER RADDRIZZARE IL SETTO NASALE, ASCH.....	449
PINZA PER AFFERRARE TESSUTI, CHAPUT.....	110	PINZA PER CATETERI COOLEY	510	PINZA PER RADDRIZZARE IL SETTO NASALE, WALSHAM	449
PINZA PER AFFERRARE TESSUTI, COLLIN.....	110	PINZA PER COARTAZIONE E ANASTOMOSI POTTS	492, 493	PINZA PER RIFIUTI SAUERBRUCH	227
PINZA PER AFFERRARE TESSUTI, SINGLEY.....	88	PINZA PER CORPI ESTRANEI STRUEMPEL	412	PINZA PER RIPOSIZIONE, ROWE.....	459
PINZA PER AFFERRARE TESSUTI, TUFFIER	110	PINZA PER CORPI ESTRANEI, MATHIEU.....	553/1	PINZA PER ROVESCIARE PALPEBRE, SNELLEN	393
PINZA PER AGRAFES, CHILDE.....	224	PINZA PER CRANIOTOMIA CONE.....	331	PINZA PER SCHEGGE.....	91
PINZA PER AGRAFES, COLLIN.....	224	PINZA PER EMORROIDI, HEYWOOD-SMITH	567	PINZA PER SCHEGGE, ARCHER.....	92
PINZA PER AGRAFES, HEGENBARTH	224	PINZA PER FILO, MCPHERSON.....	392	PINZA PER SCHEGGE, CARMALT.....	91
PINZA PER AGRAFES, MICHEL.....	224	PINZA PER FILO, MOD. TUEBINGEN	392	PINZA PER SCHEGGE, FELCHENFELD.....	91
PINZA PER AGRAFES, WACHENFELDT.....	224	PINZA PER FILO, PAUFIQUE.....	392	PINZA PER SCHEGGE, HUNTER.....	91
		PINZA PER GOZZO, LAHEY.....	479	PINZA PER SCHEGGE, PEET.....	92
		PINZA PER IL CUOIO CAPELLUTO, GAUSS	605	PINZA PER SCHEGGE, VIRTUS (RALK).....	92
		PINZA PER INTRODUZIONE SONDE MAGILL.....	28	PINZA PER SCHEGGE, STIEGLITZ.....	92
		PINZA PER IPOFISI.....	341	PINZA PER SETTO NASALE, BRUENINGS.....	425
		PINZA PER IPOFISI, ADSON.....	334	PINZA PER SETTO NASALE, HEYMANN.....	425
		PINZA PER IRIDE BARRAQUER (COLIBRI).....	384	PINZA PER SETTO NASALE, LUC.....	426
		PINZA PER IRIDE, BARRAQUER-KATZIN	384	PINZA PER SETTO NASALE, MIDDLETON-JANSEN.....	430
		PINZA PER IRIDE, BISHOP-HARMAN.....	386	PINZA PER SETTO NASALE, RUBIN.....	428
		PINZA PER IRIDE, BONN.....	387	PINZA PER SINUSCOPIA.....	431
		PINZA PER IRIDE, FISCHER.....	384	PINZA PER STERILIZZAZIONE.....	227
		PINZA PER IRIDE, FOERSTER.....	383	PINZA PER STERILIZZAZIONE DAVIS	227
		PINZA PER IRIDE, GILL.....	384	PINZA PER STERILIZZAZIONE, CHEATLE	227
		PINZA PER IRIDE, GILL-HESS	384	PINZA PER STERILIZZAZIONE, ROGGE.....	227

PINZA PER STERILIZZAZIONE, UNIVERSAL.....	227
PINZA PER STRABISMO, BONACCOLTO.....	385
PINZA PER STRABISMO, DASTOOR.....	386
PINZA PER STRABISMO, JAMESON.....	385
PINZA PER STRABISMO, MCCULLOUGH.....	385
PINZA PER SUTURA, CASTROVIEJO.....	392
PINZA PER SUTURA, MOORFIELD.....	392
PINZA PER SUTURA, ST. MARTIN.....	392
PINZA PER TAMPONI, BOZEMANN.....	138
PINZA PER TAMPONI, BOZEMANN-DOUGLAS.....	138
PINZA PER TONSILLE COLVER.....	467
PINZA PER TONSILLE, BALLENGER.....	467
PINZA PER TONSILLE, BLOHMKE.....	467
PINZA PER TONSILLE, MARSCHIK.....	468
PINZA PER TONSILLE, NEGUS.....	467
PINZA PER TONSILLE, SAWTELL.....	467
PINZA PER TONSILLE, SCHNIDT.....	467
PINZA PER TONSILLE, TYDING.....	467, 468
PINZA PER TONSILLE, WHITE.....	467
PINZA PER TRACOMA, KNAPP-LUER.....	393
PINZA PER TRAZIONE CRANIALE, CRUTCHFIELD.....	327
PINZA PER TUMORI, YASARGIL.....	97
PINZA PERITONEALE, FAURE.....	123
PINZA PERITONEALE, MIKULICZ, 20CM.....	123
PINZA PERITONEALE, MIKULICZ-BABY.....	123
PINZA PERITONEALE, PHANEUF.....	123
PINZA PORTAPLACCHE, LANE.....	325
PINZA PORTAVITI, LANE.....	325
PINZA POSA CLIPS BIEMER.....	361, 363, 364, 366
PINZA POSA CLIPS, MEHDORN.....	362
PINZA POSA CLIPS, RANEY.....	327
PINZA RENALE GUYON.....	122
PINZA SERRAPENE, STOCKMANN.....	553/1
PINZA SERRAPENE, STRAUSS.....	553/1
PINZA SERRATUBI.....	129
PINZA SERRATUBI, HOFFMANN.....	624
PINZA SERRATUBI, SIMPLEX.....	624
PINZA SFRANTOIBI, BÜLOW-GUNAR-HEY.....	130
PINZA SFENOIDALE HAJEK-KOFLER.....	430, 431
PINZA SGORBIA BANE-HARTMANN.....	237
PINZA SGORBIA MAYFIELD.....	238
PINZA SGORBIA SMITH-PETERSEN.....	238
PINZA SGORBIA, ADSON.....	236
PINZA SGORBIA, BLUMENTHAL.....	236
PINZA SGORBIA, BOEHLER.....	238
PINZA SGORBIA, CLEVELAND.....	235
PINZA SGORBIA, ECHLIN.....	240
PINZA SGORBIA, FRIEDMAN-MICRO.....	234
PINZA SGORBIA, FRIEDMAN-MINI.....	234
PINZA SGORBIA, FRYKHOLM.....	240
PINZA SGORBIA, JANSEN.....	237
PINZA SGORBIA, KLEINERT-KUTZ.....	237
PINZA SGORBIA, LEMPERT.....	237
PINZA SGORBIA, LUER.....	236
PINZA SGORBIA, MARQUARDT.....	239
PINZA SGORBIA, MEAD.....	235
PINZA SGORBIA, OLIVECRONA.....	237
PINZA SGORBIA, RUSKIN.....	239
PINZA SGORBIA, SAUERBRUCH.....	240
PINZA SGORBIA, SCAGLIETTI.....	240
PINZA SGORBIA, SEMB.....	240
PINZA SGORBIA, STELLBRINK.....	234
PINZA SGORBIA, ZAUHAL-JANSEN.....	238
PINZA SGORBIA, LEKSELL-STILLE.....	240
PINZA SGORBIA, STILLE-LUER.....	239
PINZA SGORBIA, STILLE-RUSKIN.....	239
PINZA STOMACALE LANE.....	547
PINZA STRAPPAGESSI, WOLFF.....	233
PINZA TAGLIANTE CIRCOLARE.....	432
PINZA TAGLIANTE NASALE, KERRISON.....	428
PINZA TAGLIANTE PER CAPSULA, HOLTH.....	380
PINZA TAGLIANTE PER DISCHI INTERVERTEBRALI, COLCLOUGH.....	344/1
PINZA TAGLIANTE PER DISCHI INTERVERTEBRALI, FERRIS-SMITH-KERRISON.....	344, 344/2
PINZA TAGLIANTE PER LAMINECTOMIA, CLOWARD.....	342
PINZA TAGLIANTE PER LAMINECTOMIA, OLDBERG.....	341
PINZA TAGLIANTE PER LAMINECTOMIA, SCHLESINGER.....	342
PINZA TAGLIANTE PER LAMINECTOMIA, SPURLING.....	340
PINZA TAGLIANTE PER LAMINECTOMIA, WAGNER.....	343
PINZA TAGLIANTE PER LAMINECTOMIA, CUSHING.....	340
PINZA TAGLIANTE PER LAMINECTOMIA, FERRIS-SMITH.....	343
PINZA TAGLIANTE PER LAMINECTOMIA, LOVE-GRUENWALD.....	340
PINZA TAGLIANTE PER SETTO NASALE, CITELLI.....	430
PINZA TIRALINGUA, COLLIN.....	453
PINZA TIRALINGUA, YOUNG.....	453
PINZA TORCIFILI, BERRY TC.....	319
PINZA TORCIFILI, CORWIN-HEGAR TC.....	319
PINZA TORCIFILI, MAYO-HABERISSER TC.....	319
PINZA ULTRA LIGHT.....	95
PINZA UTERINA PER EMOSTASI, GREEN-ARMYTAG.....	605
PINZA VASCOLARE BAINBRIDGE.....	495
PINZA VASCOLARE GLOVER.....	515
PINZA VASCOLARE, ADLERKREUTZ.....	84
PINZA VASCOLARE, DIEFFENBACH.....	104
PINZA VASCOLARE, LELAND-JONES.....	494
PINZA VASCOLARE, SATINSKY.....	491
PINZA VASCOLARE, STILLE-BARRAYA.....	88
PINZA, DAVIS.....	227
PINZE ATRAUMATICHE BULLDOG DE BAKEY.....	103
PINZE ATRAUMATICHE BULLDOG GLOVER.....	103
PINZE ATRAUMATICHE BULLDOG IN TITANIO.....	102
PINZE ATRAUMATICHE, DE BAKEY.....	98
PINZE PER SCHEGGE.....	90
PIPER FORCIPE.....	604
PISTOLA LAVATRICE.....	626
PISTONI.....	258, 259
PISTONI CASPAR.....	258
PLACCA PER PALPEBRE JAEGER.....	371
PLACCA PER STENDIPELLE.....	49
PLESTER CANNULA D'ASPIRAZIONE.....	338
PLESTER COLTELLO.....	418
PLESTER DIVARICATORE.....	171
POLITZER AGO PER PARACENTESI.....	408
POLITZER COLTELLO AURICOLARE.....	408
POLITZER INSOFFIATORE D'ARIA.....	406
POLITZER OLIVA NASALE.....	406
POLITZER SPECOLO AURICOLARE.....	399
POMPA D'ARIA.....	295
POOLE CANNULA D'ASPIRAZIONE.....	27
PORTA AGRAFES.....	326
PORTACOTONE, FARRELL.....	203
PORTACOTONE, JOBSON-HORNE.....	203
PORTACOTONE, HADEO.....	203
PORTACOTONE, TOBOLD.....	203
PORTACOTONE, UCKERMANN.....	203
PORT'AGHI BARRAQUER.....	216, 217
PORT'AGHI CASTROVIEJO.....	216
PORT'AGHI MICROVASCOLARE.....	210
PORT'AGHI, ADSON.....	211
PORT'AGHI, ARRUGA.....	214
PORT'AGHI, BABY-WEBSTER.....	208
PORT'AGHI, BARRAQUER-TROUTMAN.....	216
PORT'AGHI, BAUMGARTNER.....	208
PORT'AGHI, BOYNTON.....	214
PORT'AGHI, BOZEMANN.....	211
PORT'AGHI, BROWN.....	209
PORT'AGHI, CASTROVIEJO.....	215
PORT'AGHI, CASTROVIEJO MICRO.....	215
PORT'AGHI, COLLIER, 12,5CM.....	208
PORT'AGHI, CRILE.....	213
PORT'AGHI, CRILE-MURRAY.....	209
PORT'AGHI, CRILE-WOOD TC.....	209
PORT'AGHI, DE BAKEY.....	210
PORT'AGHI, DERF.....	208
PORT'AGHI, FINOCCHIETTO.....	211
PORT'AGHI, GILLIES.....	212
PORT'AGHI, HALSEY.....	208
PORT'AGHI, HALSEY.....	208
PORT'AGHI, HEANEY.....	210
PORT'AGHI, HOESEL.....	213
PORT'AGHI, JACOBSON.....	215
PORT'AGHI, JOHNSON.....	211
PORT'AGHI, KALT-ARRUGA.....	214
PORT'AGHI, KILNER.....	212
PORT'AGHI, LANGENBECK.....	213
PORT'AGHI, LICHTENBERG.....	213
PORT'AGHI, MASSON.....	210
PORT'AGHI, MATHIEU.....	213
PORT'AGHI, MATHIEU-OLSEN.....	212
PORT'AGHI, MAYO-HEGAR.....	209
PORT'AGHI, METZENBAUM.....	211
PORT'AGHI, NEIVERT.....	208
PORT'AGHI, OLSEN-HEGAR.....	212
PORT'AGHI, RYDER.....	210
PORT'AGHI, SAROT.....	211
PORT'AGHI, STEVENS.....	214
PORT'AGHI, WANGENSTEEN.....	210
PORT'AGHI, WEBSTER.....	208
PORT'AGHI, BABY-OLSEN-HEG.....	212
PORT'AGHI, STRATTE.....	212
PORTATORE DI LUCE FREDDA A FIBRE DI VETRO KLEINSASSER.....	36
POSA CLIPS.....	357, 358, 359, 360
POSA CLIPS JOHNS-HOPKINS.....	104
POSA CLIPS, MC KENZIE.....	326
POSA CLIPS, SMITHWICK.....	326
POSA CLIPS, SWEET.....	326
POST MORTEM AGO.....	268
POTTS PINZA PER COARTAZIONE E ANASTOMOSI	492, 493
POTTS SMITH PINZA CHIRURGICA.....	81
POTTS-DE MARTEL FORBICI VASCOLARI.....	59
POTTS-SMITH FORBICI VASCOLARI.....	61
POTTS-SMITH PINZA ANATOMICA.....	81
PRATT DILATATORE UTERINO.....	580
PRATT PINZA DA PRESA.....	110
PRATT PINZA PER ABBASSARE IL COLLO DELL'UTERO.....	584
PRATT SPECILLO PER FISTOLE.....	563
PRATT SPECILO RETTALE.....	559
PRECISA SFIGMOMANOMETRO.....	9
PRICE-THOMAS PINZA PER BRONCHI.....	490
PRINCE FORBICI PER TONSILLE.....	59
PRINCE PINZA MUSCOLARE.....	387
PROTEGGIDITA, LANGENBECK.....	311
PROCTOSCOPO BENSAUDE.....	565
PROCTOSCOPO MORGAN.....	565
PROCTOSCOPO, CHELSEA-EATON.....	563
PROCTOSCOPO, FANSLER.....	565
PROCTOSCOPO, KELLY.....	563
PROVIDENCE-HOSPITAL PINZA EMOSTATICA.....	106
PUNTE PER SPECILLI.....	201
PUTTI RASPA PER OSSA.....	294
Q	
QUERVAIN ELEVATORE.....	275
QUINBY FORBICI GINGIVALI.....	67
QUIRE LEVA PER CORPI ESTRANEI.....	412
QUISLING MARTELLO.....	271

R		
RACCORDO DI LAVAGGIO.....	626	
RACHITOMO.....	267	
RADOLF PINZA PER LACERAZIONE UNGHIE.....	297	
RAGNELL DIVARICATORE.....	140	
RALK PERFORATORE A MANO.....	300	
RAMPLEY PINZA PER MEDICATURA.....	136	
RAMUS DIVARICATORE.....	461	
RANDALL CURETTA PER BIOPSIA.....	587	
RANDALL PINZA PER CALCOLI RENALI.....	535	
RANEY GRAFFA PER IL CUIO CAPELLUTO.....	327	
RANEY PINZA POSA CLIPS.....	327	
RASCHIATOIO CORNEALE, KUHNH.....	373	
RASOIO.....	49	
RASPA NASALE FOMON TC.....	445	
RASPA NASALE GALLAHER.....	446	
RASPA NASALE MILLER.....	444	
RASPA NASALE PEET.....	446	
RASPA NASALE, FOMON.....	444	
RASPA NASALE, JOSEPH.....	443	
RASPA NASALE, JOSEPH (LEWIS).....	443	
RASPA NASALE, MALTZ.....	443	
RASPA NASALE, MALTZ (COTTLE).....	444	
RASPA NASALE, WIENER.....	443	
RASPA PER OSSA.....	294	
RASPA PER OSSA PUTTI.....	294	
RECAMIER CURETTE UTERINI.....	597	
RECIPIENTE CILINDRICO.....	620	
HADEO DIAPASON.....	403	
HADEO CALAMITA OCULISTICA.....	395	
HADEO COLTELLO FALCATO.....	435	
HADEO COLTELLO PER AMPUTAZIONE.....	44	
HADEO CURETTA TAGLIANTE.....	256	
HADEO DIVARICATORE PER GESSI.....	232	
HADEO EXCENTER FORBICI PER BENDAGGI.....	69/2	
HADEO PERFORATORE A MANO.....	300	
HADEO PINZA COPERCHIO.....	615	
HADEO PINZA DEPIILATORIA.....	395	
HADEO PINZA PER AFFERRARE INTESTINI.....	111	
HADEO PORTACOTONE.....	203	
HADEO ROMPILAMETTE.....	45	
HADEO SEGA TAGLIA ANELLI.....	297	
HADEO SONDA CONDUTTRICE A FORCHETTA.....	221	
HADEO SPECOLO NASALE.....	423	
HADEO UNCINO PER LA PELLE.....	150	
REDON AGO DI GUIDA.....	207	
REES FACE LIFT FORBICI.....	73	
REGOLO DI METALLO.....	25	
REICHERT DEPRESSORE PER EPIGLOTTIDE.....	471	
REILL TENAGLIA PER OSSA.....	248	
REINER COLTELLO PER GESSI.....	233	
REINER SIRINGA AURICOLARE.....	406	
RESANO PINZA INTESTINALE.....	542	
RESANO, FORBICI PER CAPSULA.....	53/2	
RETRATORE, PERCY.....	296	
RETRATTORI INTRAORALI.....	463/1	
RETRATTORI INTRAORALI.....	463/4	
REVERDIN AGO.....	220	
REVERDIN SPATOLA ADDOMINALE E INTESTINALE.....	143/1	
REYNOLDS FORBICI PER CHIRURGIA.....	54	
REYNOLDS SUPERCUT FORBICI.....	72	
RIBBON SPATOLA ADDOMINALE E INTESTINALE.....	143	
RICARD DIVARICATORE ADDOMINALE.....	191	
RICHARDSON DIVARICATORE.....	142	
RICHARDSON-EASTMAN DIVARICATORE.....	142	
RICHARDSON-GRIP DIVARICATORE.....	142	
RICHNAU-HOLMGREN SPECOLO AURICOLARE.....	400	
RICHTER-HEATH PINZA PER AGRAFES.....	224	
RIENHOFF-FINOCCHIETTO DIVARICATORE COSTALE.....	486	
RIGBY DIVARICATORE ADDOMINALE.....	189/2	
RI-MINI COMBINAZIONE PER DIAGNOSTICA		
CON ILLUMINAZIONE ALOGENA.....	17	
RITTER-HALLE DILATATORE PER SENO FRONTALE.....	433	
ROBB SPATOLA.....	530	
ROBERTS PINZA EMOSTATICA.....	117	
ROCHARD DIVARICATORE ADDOMINALE.....	186	
ROCHARD SUPPORTO.....	186	
ROCHESTER-CARMALT.....	109	
ROCHESTER-OCHSNER PINZA EMOSTATICA.....	108	
ROCHESTER-PEAN PINZA EMOSTATICA.....	108	
ROEDER PINZA FISSATELI.....	132	
ROGER ELEVATORE PER SETTO.....	437, 438	
ROGERS PINZA PER ISTERECTOMIA.....	127	
ROGGE PINZA PER STERILIZZAZIONE.....	227	
ROLLET SCALPELLO ESTIRPATORE.....	374	
ROLLET UNCINO DIVARICATORE.....	375	
ROMPILAMETTE, CASTROVIEJO.....	45	
ROMPILAMETTE, HADE.....	45	
ROMPILAMETTE, TROUTMAN-CHRIS.....	45	
ROSE DIVARICATORE.....	140	
ROSEN AGO.....	419	
ROSEN CANNULA D'ASPIRAZIONE.....	338	
ROSEN COLTELLO.....	418	
ROSER-KOENIG APRIBOCCA.....	454	
ROTATORE PER NUCLEO BECHERT.....	379	
ROUX MINI DIVARICATORE.....	140	
ROUX DIVARICATORE.....	139	
ROUX-BABY DIVARICATORE.....	140	
ROWE PINZA PER RIPOSIZIONE.....	459	
RUBIN OSTEOTOMO PER SETTO.....	440	
RUBIN PINZA PER SETTO NASALE.....	428	
RUDD LEGATORE EMORROIDALE.....	568	
RUMEL PINZA EMOSTATICA.....	117	
RUMEL-BELMONT TOURNIQUET.....	528	
RUSKIN PINZA SGORBIA.....	239	
RUSKIN-LISTON CESCOIA PER OSSA.....	241	
RUSSEL-DAVIS ABBASSALINGUA.....	458	
RYDEL-SEIFFERT DIAPASON.....	404	
RYDER PORT AGHI.....	210	
S		
SAALFELD SCHIACCIACOMEDONI.....	608	
SACHS DURA DISSETTORE.....	332	
SACHS UNCINO PER NERVI.....	329	
SAENGER PINZA PER ABORTO.....	606	
SALPINGOGRAFO.SCHULTZE.....	596	
SANVENERO FORBICI PER CHIRURGIA.....	54	
SAROT PINZA EMOSTATICA.....	118	
SAROT PORT AGHI.....	211	
SATINSKY FORBICI VASCOLARI.....	65/2	
SATINSKY PINZA VASCOLARE.....	491	
SATO DISSETTORE CORNEALE.....	373	
SATTERLEE SEGA PER AMPUTAZIONE.....	296	
SAUERBRUCH COSTOTOMO.....	481	
SAUERBRUCH DIVARICATORE.....	164	
SAUERBRUCH DIVARICATORE.....	166	
SAUERBRUCH PINZA PER RIFIUTI.....	227	
SAUERBRUCH PINZA SGORBIA.....	240	
SAUERBRUCH-FREY COSTOTOMO.....	481	
SAWTELL PINZA PER TONSILLE.....	467	
SAWYER SPECOLO RETTALE.....	560	
SAYRE ELEVATORE.....	281	
SCAGLIETTI PINZA SGORBIA.....	240	
SCALP-CONTOUR DIVARICATORE.....	169	
SCALPELLI.....	259	
SCALPELLO ESTIRPATORE, ROLLET.....	374	
SCALPELLO PARTSCH.....	259	
SCALPELLO PER SETTO, CINELLI.....	441	
SCALPELLO PER SETTO, COTTLE.....	440	
SCALPELLO PER SETTO, FREER.....	439	
SCALPELLO PER SETTO, SILVER.....	442	
SCALPELLO, ALEXANDER.....	259	
SCALPELLO, BRUNETTI.....	268	
SCALPELLO, HIBBS.....	265	
SCALPELLO, STILLE.....	260	
SCATOLA PER STERILIZZARE AGHI.....	615	
SCATOLA PER STERILIZZARE AGHI.....	615	
SCATOLA PER STRUMENTI.....	616, 617, 618	
SCHAEDEL PINZA FISSATELI.....	132	
SCHAMBERG SCHIACCIACOMEDONI.....	608	
SCHEDI CURETTA TAGLIANTE.....	251	
SCHIEH COLTELLO PER GONIOTOMIA.....	373	
SCHENMANN INSERTO.....	472	
SCHERBAK SPECOLO VAGINALE.....	575	
SCHIACCIACOMEDONI, SAALFELD.....	608	
SCHIACCIACOMEDONI, SCHAMBERG.....	608	
SCHIACCIACOMEDONI, UNNA.....	608	
SCHIACCIACOMEDONI, WALTON.....	608	
SCHIACCIATORE PER L'INTESTINO E LO STOMACO, PAYR.....	548	
SCHIMMELBUSCH TAMBURO.....	622	
SCHINK DERMATOMO.....	49	
SCHIOETZ TONOMETRO.....	394/2	
SCHLESINGER PINZA TAGLIANTE PER LAMINECTOMIA.....	342	
SCHMEDEN PINZA NASALE.....	427	
SCHMID CANNULA PER IRRIGAZIONE.....	338	
SCHMIEDEN SPECILLO DI GUIDA SCANALATO.....	221	
SCHMIEDEN-DICK AGO PER LEGATURE.....	219	
SCHMIEDEN-TAYLOR FORBICI PER DURAMADRE.....	65/1	
SCHNIDT PINZA PER TONSILLE.....	467	
SCHOENBORN DIVARICATORE PER TIROIDE.....	479	
SCHRÖDER CUCCHIAIO UTERINO.....	595	
SCHROEDER(POZZI) PINZA PER ABBASSARE IL COLLO DELL'UTERO.....	582	
SCHUBERT PINZA PER BIOPSIA.....	588	
SCHUKNECHT COLTELLO.....	418	
SCHULTZE SALPINGOGRAFO.....	596	
SCHULZE-BERGMANN SPECOLO RETTALE.....	560	
SCHUMACHER FORBICI PER STERNO.....	481	
SCHUMACHER INSERTO.....	472	
SCHUMACHER PINZA PER BIOPSIA.....	588, 589	
SCHWEIGGER PINZA CAPSULARE.....	391	
SCLEROTOMO, GUYTON-LUNDGGAARD.....	373	
SCLEROTOMO, LUNDGGAARD.....	373	
SCOVILLE CURETTA TAGLIANTE.....	253	
SCOVILLE DIVARICATORE PER LAMINECTOMIA.....	196	
SCOVILLE UNCINI PER RADICI DEI NERVI.....	330	
SCOVILLE VALVE.....	196	
SCOVILLE-HAVERFIELD DIVARICATORE PER LAMINECTOMIA.....	196	
SCUDDER PINZA INTESTINALE.....	541	
SEBILAU ELEVATORE.....	275	
SEDILOTT PERIOTOTOMO.....	274, 275	
SEGA , GIGLI.....	332	
SEGA ELETTRICA PER GESSI.....	230	
SEGA IN FILO D'ACCIAIO, OLIVECRONA.....	332	
SEGA NASALE , JOSEPH.....	446	
SEGA OSCILLANTE PER GESSI CON ASPIRAZIONE.....	231	
SEGA PER AMPUTAZIONE BIER.....	296	
SEGA PER AMPUTAZIONE, CHARRIERE.....	296	
SEGA PER AMPUTAZIONE, SATTERLEE.....	296	
SEGA PER AUTOPSIA.....	231/1	
SEGA PER DITA, LANGENBECK.....	296	
SEGA PER GESSI, ENGEL.....	229	
SEGA TAGLIA ANELLI, HADEO.....	297	
SEGA TAGLIA ANELLI, WALTON.....	297	
SEKOND BISTURI PER FIBROMI.....	594	
SEKOND PINZA PER ISTERECTOMIA.....	125	
SEKOND-LANDAU PINZA PER ISTERECTOMIA.....	125	
SEIFFERT INSERTO.....	472	
SELDIN PERIOTOTOMO.....	277	
SELLHEIM CUCCHIAIO OSTETRICO.....	607	
SEMB CESCOIA PER OSSA.....	242	
SEMB PERIOTOTOMO.....	278	
SEMB PINZA PER BRONCHI.....	491	
SEMB PINZA SGORBIA.....	240	
SEMB TENAGLIA PER OSSA.....	243	
SEMKEN PINZA ANATOMICA.....	86	

SEMKEN PINZA CHIRURGICA	86	SINGLEY PINZA PER AFFERRARE TESSUTI	88	SPECILLO DI GUIDA SCANALATO, SCHMIEDEN	221
SEMM SPECOLO VAGINALE	571	SINSKEY UNCINO	376	SPECILLO DI GUIDA, VIENNA	221
SENN-GREEN DIVARICATORE	153	SINUS ELEVATORE PER SETTO	438	SPECILLO FOGLIA MIRTE	199
SENN-MILLER DIVARICATORE	143	SIRINGA AURICOLARE	407	SPECILLO PER CANALE LACRIMALE BOWMAN	381
SEPERATORE PER IL CORPO MANDIBOLARE HARGIS	463/6	SIRINGA AURICOLARE, REINER	406	SPECILLO PER FISTOLE LOCKHART-MUMMERY	200
SEPERATORI SAGITTALI SMITH	463/5	SIRINGA PER TONSILLE	470	SPECILLO PER FISTOLE, PRATT	563
SEPTEMZANGE KNIGHT	425	SISTEMA DI FISSAGGIO, LEYLA	368, 368/1, 368/2, 368/3, 368/4	SPECILLO SCANALATO	199
SERPENTINE PINZA PER BIOPSIA	593	SISTEMA RETRATTORE	188	SPECILLO SCANALATO, BRODIE	199
SERRANODI KRAUSE	433/2	SKENE PINZA PER ABBASSARE IL COLLO	470	SPECILLO SCANALATO, DOYEN	199
SERRANODI KRAUSE-VOSS,	433/2	DELL'UTERO	582	SPECILLO SCANALATO, NELATON	199
SERRANODI PER TONSILLE, BRUENINGS	468	SLS PINZA APPLICATORE CLIPS MICRO	524, 525	SPECILLO, FISH	199
SERRANODI PER TONSILLE, EVES	468	SLUDER-BALLENGER TONSILLOTOMO	470	SPECILLO, WATSON-CHEYNE	199
SERRANODI RETTALE, WESTON	566	SMELLIE PERFORATORE	607	SPECILO AURICOLARE RICHNAU-HOLMGREN	400
SERRANODI WILDE	433/2	SMELLIE UNCINO	605	SPECILO AURICOLARE, BOUCHERON	399
SET LARINGOSCOPIO FOREGGER	31	SMELLIE COLTELLO PER MENISCO	292	SPECILO AURICOLARE, BRUENINGS	401
SET LARINGOSCOPIO MC INTOSH	31	SMILLIE ELEVATORE PER OSSA	291	SPECILO AURICOLARE, GRUBER	399
SET PER INFERMERIA	609	SMITH BLEFAROSTATO	370	SPECILO AURICOLARE, HARTMANN	399
SET PER SUTURA IN ASTUCCIO DI METALLO	225, 226	SMITH SEPARATORI SAGITTALI	463/5	SPECILO AURICOLARE, POLITZER	399
SET PER TRACHEOTOMIA	478	SMITH US ARMY FORBICI PER BENDAGGI	69/1	SPECILO AURICOLARE, SIEGLE	402
SET PER VARICI IN SCATOLA DI METALLO, NABATOFF	201	SMITH-BUIE DIVARICATORE ANALE	561	SPECILO AURICOLARE, TOYNBEE	399
SEUTIN FORBICI PER BENDAGGI	69/2	SOMER PINZA PER AFFERRARE L'UTERO	261	SPECILO LATERALE	569
SEXTON COLTELLO AURICOLARE	408	SMITH-PETERSEN OSTEOTOMO	238	SPECILO NASALE HARTMANN	422
SFIGMOMANOMETRO, BABYPHON	10	SMITH-PETERSEN PINZA SGORBIA	238	SPECILO NASALE HADEO	423
SFIGMOMANOMETRO, DIPLOMAT	5	SMITHWICK PINZA POSA CLIPS	326	SPECILO NASALE, COTTLE	423
SFIGMOMANOMETRO, EXACTA	8	SMITHWICK UNCINO PER NERVI	329	SPECILO NASALE, HARTMANN-HALLE	421
SFIGMOMANOMETRO, MINIMUS II	11	SNELLEN ANSA PER CATERATA	378	SPECILO NASALE, KILLIAN	423
SFIGMOMANOMETRO, MINIMUS III	12	SNELLEN PINZA PER ROVESCIARE PALPEBRE	393	SPECILO NASALE, MOD.VIENNA	421
SFIGMOMANOMETRO, NOVA	6,7	SOMER PINZA PER AFFERRARE L'UTERO	585	SPECILO NASALE, THUDICHUM	421
SFIGMOMANOMETRO, PRECISA	9	SONDA BOTTUNUTA, JACOBSON	335	SPECILO NASALE, TIECK-HALLE	423
SGORBIA	264	SONDA CONDUITTRICE A FORCHETTA	475	SPECILO NASALE, VOLTOLINI	421
SGORBIA, PARTSCH	259	SONDA CONDUITTRICE A FORCHETTA HADEO	221	SPECILO RETTALE HILL-FERGUSON	560
SGORBIA ALEXANDER	259	SONDA PER CALCOLI BILIARI DESJARDINS	532	SPECILO RETTALE SAWYER	560
SGORBIA BRÜNINGGS-LUCAS	260	SONDA PER CALCOLI BILIARI MOYNIHAN	532	SPECILO RETTALE, ALAN-PARKS	561
SGORBIA KILLIAN	442/1	SONDA PER CALCOLI BILIARI, MAYO	534	SPECILO RETTALE, BARR	559
SGORBIA PER CORPI ESTRANEI, DIX	374	SONDA PER GOZZO, KOCHER	479	SPECILO RETTALE, BODENHAMMER	559
SGORBIA PER CORPI ESTRANEI, ELLIS	374	SONDA, WORST	381	SPECILO RETTALE, CZERNY	559
SGORBIA PER CORPI ESTRANEI, WALTON	374	SONDA, WORST	381	SPECILO RETTALE, RATHIEU	560
SGORBIA PER SETTO FREER	442/1	SPATOLA ADDOMINALE	144	SPECILO RETTALE, PRATT	559
SGORBIA PER SETTO, HAJEK	442/1	SPATOLA ADDOMINALE E INTESTINALE LERICHE	143/2	SPECILO RETTALE, SIMS	559
SGORBIA PER SETTO, KILLIAN-CLAUS	442/1	SPATOLA ADDOMINALE E INTESTINALE, HABERER	143/1	SPECILO RETTALE, SCHULZE-BERG	560
SGORBIA WEST	442/1	SPATOLA ADDOMINALE E INTESTINALE, REVERDIN	143/1	SPECILO VAGINALE, JACKSON	573
SGORBIA, COBB	262	SPATOLA ADDOMINALE E INTESTINALE, RIBBON	143	SPECILO VAGINALE, AUWARD	576
SGORBIA, HIBBS	265	SPATOLA ADDOMINALE ED INTESTINALE KADER	143/1	SPECILO VAGINALE, BREISKY	577
SGORBIA, LEXER MINI	263	SPATOLA ADDOMINALE ED INTESTINALE KÖRTE	143/1	SPECILO VAGINALE, COLLIN	570
SGORBIA, ZIELKE	264	SPATOLA ADDOMINALE ED INTESTINALE KÜMMEL	143/2	SPECILO VAGINALE, CUSCO	570, 571
SGORBIA, STILLE	260	SPATOLA CEREBRALE CUSHING	369	SPECILO VAGINALE, DOYEN	574
SGORBIE	259	SPATOLA CEREBRALE DAVIS	337	SPECILO VAGINALE, FRIEDMANN	577
SHAMBAUGH UNCINO	419	SPATOLA CEREBRALE HEIFETZ	369	SPECILO VAGINALE, GRAVE	570
SHAPLEIGH ANSA AURICOLARE	410	SPATOLA CEREBRALE, CUSHING	336	SPECILO VAGINALE, KALLMORGEN	573
SHEA MICRO FORBICI AURICOLARI	413	SPATOLA CEREBRALE, OLIVECRONA	336	SPECILO VAGINALE, KRISTELLER	572
SHEEHAN OSTEOTOMO PER SETTO	441	SPATOLA PER CICLODIALISI HIRSCHMAN	379	SPECILO VAGINALE, LANDAU	577
SHEETS CANNULA PER IRRIGAZIONE	394/2	SPATOLA PER CICLODIALISI, BANGERTER	379	SPECILO VAGINALE, O'SULLIVAN-O'CONNOR	576
SIEBENMANN CANNULA PER IRRIGAZIONE	433	SPATOLA PER CICLODIALISI, ELSCHNIG	379	SPECILO VAGINALE, PEDERSON	570
SIEBOLD FORBICI GINECOLOGICHE	62	SPATOLA PER CICLODIALISI, WHEELER	379	SPECILO VAGINALE, SEMM	571
SIEGLE SPECILO AURICOLARE	402	SPATOLA PER CICLODIALISI, CASTROVIEJO	379	SPECILO VAGINALE, SIMS	573
SILVER DERMATOMO	50	SPATOLA PER IRIDE, CULLER	378	SPECILO VAGINALE, TRELAT	571
SILVER SCALPELLO PER SETTO	442	SPATOLA PER IRIDE, WECKER	378	SPECILO VAGINALE, VU-MORE	569
SIMCOE CANNULA PER IRRIGAZIONE	394	SPATOLA PER PEDICURE	612	SPECILO VAGINALE, SCHERBAK	575
SIMON CUCCHIAIO UTERINO	594	SPATOLA PER POLMONE, ALLISON	489	SPENCER FORBICI PER LEGATURE	66
SIMON DIVARICATORE	164	SPATOLA ROBB	530	SPENCER-WELLS PINZA EMOSTATICA	109
SIMPLEX PINZA SERRATUBI	624	SPATOLA VESCICALE, KOCHER	552	SPEZZATORE UNGHIE	612/1
SIMPSON FORCIPE	602	SPATOLA VESCICALE, LEGUEU	552	SPILLONE PER STERILIZZAZIONE, BUNT	227
SIMPSON-BRAUN FORCIPE	602	SPAZZOLA PER UNGHIE	611	SPILLONE PER STERILIZZAZIONE, MAYO	227
SIMPSON-LUIKART FORCIPE	603	SPECCHIO FRONTALE ZIEGLER	21	SPINAL CURETTA TAGLIANTE	253
SIMS CURETTA UTERINI	597, 598	SPECCHIO LARINGEO	473	SPINA-NASALIS DIVARICATORE	461
SIMS DEPRESSORE UTERINO	586	SPECCHIO LARINGEO, MICHEL	423	SPRATT CURETTA TAGLIANTE	251
SIMS DILATATORE UTERINO	581	SPECILLO AURICALE, STACKE	199	SPURLING PINZA TAGLIANTE PER LAMINECTOMIA	340
SIMS FORBICI GINECOLOGICHE	62	SPECILLO DI GUIDA SCANALATO KÖNIG	221	SPUTACCHIERA	621
SIMS ISTEROMETRO	586	SPECILLO DI GUIDA SCANALATO BRUNNER	221	ST. CLAIR-THOMSON COLTELLO ADENOIDE	450
SIMS SPECILO RETTALE	559	SPECILLO DI GUIDA SCANALATO KIRSCHNER	221	ST. MARKS DIVARICATORE PELVICO	165
SIMS SPECILO VAGINALE	573	SPECILLO DI GUIDA SCANALATO SCHMIEDEN-PAYR	221	ST. MARTIN PINZA PER SUTURA	392
SIMS-MAIER PINZA PER MEDICATURA	134	SPECILLO DI GUIDA SCANALATO, BRUNNER	221	STACKE SPECILO AURICALE	199
		SPECILLO DI GUIDA SCANALATO, PAYR	221	STANDARD FORBICI PER CHIRURGIA	51

STAUDE-MOORE PINZA PER ABBASSARE IL COLLO		
DELL'UTERO	582	
STEINMANN CHIODI	307, 308	
STEINMANN PINZA PER AFFERRARE TENDINI	292	
STELLBRINK PINZA SGORBIA	234	
STERNBERG DIVARICATORE PER GUANCE	453	
SCALPELLO PER STERNO, LEBSCHÉ	267	
STETOSCOPIO, ANESTOPHON	23	
STETOSCOPIO, DUPLEX	23	
STETOSCOPIO, PINARD	23	
STETOSCOPIO	23	
STEVENS FORBICI PER OFTALMOLOGIA	58	
STEVENS PINZA PER IRIDE	383	
STEVENS PORT'AGHI	214	
STEVENS SUPERCUT FORBICI	72	
STEVENS UNCINO PER TENOTOMIA	375	
STEVENSON BLEFAROSTATO	371	
STIEGLITZ PINZA PER SCHEGGE	92	
STILLE CESOIA PER GESSI	229	
STILLE COSTOTOMO	480	
STILLE OSTEOTOMO	260	
STILLE PERFORATORE A MANO	298	
STILLE PINZA ANATOMICA	81	
STILLE PINZA CHIRURGICA	81/1	
STILLE PINZA EMOSTATICA	122	
STILLE SCALPELLO	260	
STILLE SGORBIA	260	
STILLE-BARRAYA PINZA VASCOLARE	88	
STILLE-HORSLEY CESOIA PER OSSA	242	
STILLE-LISTON CESOIA PER OSSA	242	
STILLE-LUER PINZA SGORBIA	239	
STILLE-RUSKIN PINZA SGORBIA	239	
STILLE-SHERMAN PERFORATORE A MANO	298	
STOCKMANN PINZA SERRAPENE	553/1	
STONE-WATT COMPRESSORE	545	
STRANDELL-STILLE DIVARICATORE	157	
STRATTE PORT'AGHI	212	
STRAUSS PINZA SERRAPENE	553/1	
STRUEMPEL PINZA PER CORPI ESTRANEI	412	
STRULLY FORBICI PER NEUROCHIRURGIA	65	
STRUMENTI PER CORPI ESTRANEI, DIX	380	
STRUMENTO PER CIRCONCISIONE	556	
STRUMENTO PER MISURE	594	
STRUMENTO PER VARICI VARADY	202	
STRUMENTO TENDIFILI, DEMEL	315	
STRUMENTO TENDIFILI, LOUTE	315	
STRUYCKEN PINZA NASALE	427	
STUOJA IN SILICONE	616	
SUBRAMANIAN-MINIATURE PINZA PER AORTA PEDRIATICA	521	
SUPERCUT FORBICI	71	
SUPERCUT FORBICI IRIS	72	
SUPERCUT FORBICI KILNER	72	
SUPERCUT FORBICI LISTER	72	
SUPERCUT FORBICI REYNOLDS	72	
SUPERCUT FORBICI STEVENS	72	
SUPERCUT FORBICI WAGNER	72	
SUPERCUTFORBICI MAYO	71	
SUPERCUTFORBICI MAYO-STILLE	71	
SUPERCUTFORBICI METZENBAUM	71	
SUPERCUTFORBICI, BABY METZENBAUM	71	
SUPPORTO PER PETTO NEGUS	459	
SUPPORTO PER STERILIZZAZIONE FILI KIRSCHNER	305	
SUPPORTO PER TUBO	188	
SUPPORTO UNIVERSALE PER DIVARICATORI	188	
SUPPORTO UNIVERSALE PER ENDOSCOPIO	188	
SUPPORTO, ROCHARD	186	
SWEET PINZA POSA CLIPS	326	
SYSTRUNK FORBICI PER CHIRURGIA	66	
T		
TABB COLTELLO	418	
TAKAHASHI PINZA NASALE	427	
TAMBURO, SCHIMMELBUSCH	622	
TAMPONATORE, LUNIATSCHEK	465	
TARNIER CRANIOCLASTO	607	
TARNIER FORCIPE	604	
TAYLOR - USA MARTELLO DA PERCUSSIONE	24	
TAYLOR DIVARICATORE SPINALE	291	
TAYLOR PINZA CHIRURGICA	87	
TC FORBICI PER CHIRURGIA FINE, REYNOLDS TC	54	
TC FORBICI PER CHIRURGIA STANDARD	51	
TC PINZA ANATOMICA	81	
TC PINZA CHIRURGICA	81	
TC PINZA CUSHING	83	
TC PINZA CUSHING TAYLOR	87	
TC PINZA GILLIES	86	
TC PINZA SEMKEN	86	
TC PINZA WANGENSTEEN	89	
TEALE PINZA PER ABBASSARE IL COLLO DELL'UTERO	583	
TEBBETS DIVARICATORE PER CHIRURGIA PLASTICA	197	
TELAIO PIEGABILE KIRSCHNER	187	
TENAGLIA PER OSSA	247	
TENAGLIA PER OSSA, LANE	249	
TENAGLIA PER OSSA BIRCHER-GANSKE	246	
TENAGLIA PER OSSA, ADSON	298	
TENAGLIA PER OSSA, DINGMANN	246	
TENAGLIA PER OSSA, FARABEUF	243	
TENAGLIA PER OSSA, FARABEUF-L	243	
TENAGLIA PER OSSA, FERGUSSON	243	
TENAGLIA PER OSSA, KERN	244	
TENAGLIA PER OSSA, LAMBOTTE	244	
TENAGLIA PER OSSA, LANE	244	
TENAGLIA PER OSSA, LANGENBECK	243	
TENAGLIA PER OSSA, LEWIN	246	
TENAGLIA PER OSSA, MARTIN	246	
TENAGLIA PER OSSA, REILL	248	
TENAGLIA PER OSSA, SEMB	243	
TENAGLIA PER OSSA, ULRICH	248	
TENAGLIA PER OSSA, VAN BUREN	249	
TENAGLIA PER OSSA, VERBRUGGE	245	
TENAGLIE TAGLIAFILII	317, 318	
TERSON PINZA CAPSULARE	391	
TESSIER DIVARICATORE	463/3	
THOMAS CURETTE UTERINI	599	
THOMAS-GAYLOR PINZA PER BIOPSIA	588	
THOMS-ALLIS PINZA PER AFFERRARE INTESTINI	538	
THOMSON-WALKER DIVARICATORE VESCICALE	552	
THOREK, FORBICI TORACALI	65/2	
THUDICHUM SPECOLO NASALE	421	
TIECK-HALLE SPECOLO NASALE	423	
TILLEY PINZA AURICOLARE	411	
TIRAMIOMI, DOYEN	594	
TIRAVENE	202	
TISCHLER PINZA PER BIOPSIA	591	
TISCHLER-KEVORKIAN PINZA PER BIOPSIA	592	
TISCHLER-MORGAN PINZA PER BIOPSIA	590, 591	
TITAN PINZA EMOSTATICA, CRILE,	107	
TITAN PINZA EMOSTATICA, KELLY,	106	
TOBOLD ABBASSALINGUA	453	
TOBOLD PORTACOTONE	203	
TOENNIS DURA DISSETTORE	332	
TOENNIS PINZA EMOSTATICA	117	
TOENNIS-ADSON FORBICI PER NEUROCHIRURGIA	65	
TOGLILAMA	42	
TOHUKU PINZA FISSATELI	132	
TONOMETRO, SCHIÖETZ	394/2	
TONSILLOTOMO, SLUDER-BALLENGER	470	
TONSILLOTOMO, TYDING	469	
TOOK DISSETTORE CORNEALE	373	
TOURNIQUET RUMEL-BELMONT	528	
TOWNSEND PINZA PER BIOPSIA	591	
TOWNSEND MANICO SOLO	591	
TOYNEBEE SPECOLO AURICOLARE	399	
TRASFORMATORE RICARICA BATTERIA	34	
TRATTORE, BARTON	603	
TRATTORE, BILL	604	
TRATTORE, LUIKART-BILL	604	
TRAVERS DIVARICATORE	172	
TREFINA CUTANEA, KEYES	608	
TRELAT SPECOLO VAGINALE	571	
TREQUARTO PER SENO MASCELLARE, COAKLEY	204	
TREQUARTO PER SENO MASCELLARE, LICHTWITZ	204	
TREQUARTO PER SENO MASCELLARE, PIERCE	204	
TREQUARTO PER SINOSCOPIA	205	
TREQUARTO PER SINOSCOPIA	205	
TREQUARTO, NELSON	205	
TREQUARTO, OCHSNER	205	
TREQUARTO, UNIVERSAL	204	
TREQUARTO, STANDARD (NELSON)	204	
TROELTSCH PINZA AURICOLARE	424	
TROEMNER PERKUSSIONSMARTELLO	24	
TRONCHESINA PER PELLE	610	
TRONCHESINA PER UNGHIE	612/1, 613	
TRONCHESINA PER UNGHIE ANVIL	613	
TRONCHESINA PER UNGHIE, TURNBULL	609	
TROUSSEAU DILATATORE TRACHEALE	476	
TROUSSEAU-BABY DILATATORE TRACHEALE	476	
TROUTMAN PINZA PER IRIDE	389	
TROUTMAN-CHRIS ROMPLAMETTE	45	
TUBBS DILATATORE	528	
TÜBINGEN PINZA PER FILO	392	
TUBO DI PROLUNGAMENTO, BRUENINGS	472	
TUFFIER DIVARICATORE	147	
TUFFIER DIVARICATORE COSTALE	487	
TUFFIER PINZA PER AFFERRARE TESSUTI	110	
TURNBULL TRONCHESINA PER UNGHIE	609	
TURREL PINZA INTESTINALE PER BIOPSIA	567	
TYDING PINZA PER TONSILLE	467, 468	
TYDING TONSILLOTOMO	469	
U		
UCKERMANN PORTACOTONE	203	
ULRICH PINZA PER MEDICATURA	135	
ULRICH TENAGLIA PER OSSA	248	
ULTRA-LIGHT-PINZA, ATRAUMATICA	95	
UNCINO ACUTO LAHEY	149	
UNCINO DI FISSAZIONE, BURCH	373	
UNCINO DIVARICATORE, KNAPP	375	
UNCINO DIVARICATORE, ROLLET	375	
UNCINO ESTRATTORE	322	
UNCINO ESTRATTORE, ARRUGA	375	
UNCINO GALEA, YASARGIL	330	
UNCINO GASS	376	
UNCINO KUGLEN	376	
UNCINO NASALE AUFRICHT	447	
UNCINO NASALE CONVERSE	448	
UNCINO NASALE UNCINO	447	
UNCINO NASALE, COTTLE	447	
UNCINO NASALE, MASING-NEIVERT	447	
UNCINO PER DURA MADRE, JACOBSON	335	
UNCINO PER DURAMADRE	335	
UNCINO PER DURAMADRE, ADSON	329	
UNCINO PER FISTOLE, EMMETT	594	
UNCINO PER IL STRABISMO, GRAEFE	375	
UNCINO PER IL STRABISMO, GREEN	375	
UNCINO PER IL STRABISMO, JAMESON	375	
UNCINO PER IRIDE, O'CONNOR	375	
UNCINO PER IRIDE, WIENER	375	
UNCINO PER LA PELLE GRAEFE	149	
UNCINO PER LA PELLE, COTTLE-NEIVERT	448	
UNCINO PER LA PELLE, FOMON	447/1	
UNCINO PER LA PELLE, FRAZIER	149	
UNCINO PER LA PELLE, FREER	448	
UNCINO PER LA PELLE, GILLIES	448	

UNCINO PER LA PELLE, GUTHRIE.....	149
UNCINO PER LA PELLE, JOSEPH.....	149
UNCINO PER LA PELLE, KILNER.....	608
UNCINO PER LA PELLE, KLEINERT-KUTZ.....	149
UNCINO PER LA PELLE, HADEO.....	150
UNCINO PER LE PINNE NASALI LANGE.....	448
UNCINO PER MUSCOLI.....	267
UNCINO PER NERVI D'ERRICO.....	329/2
UNCINO PER NERVI, CRILE.....	328
UNCINO PER NERVI, CUSHING.....	328
UNCINO PER NERVI, DANDY.....	328
UNCINO PER NERVI, GRAHAM.....	329
UNCINO PER NERVI, HESS.....	329/1
UNCINO PER NERVI, KRAYENBUEHL.....	336
UNCINO PER NERVI, LOVE.....	329/2
UNCINO PER NERVI, SACHS.....	329
UNCINO PER NERVI, SMITHWICK.....	329
UNCINO PER RADICI DEI NERVI, HOLLSHER.....	329/1
UNCINO PER RADICI DEI NERVI, LOVE.....	330
UNCINO PER RADICI DEI NERVI, SCOVILLE.....	330
UNCINO PER TENOTOMIA, STEVENS.....	375
UNCINO SHAMBAUGH.....	419
UNCINO SINSKEY.....	376
UNCINO SPEZZATORE, BRAUN.....	607
UNCINO, BARBARA.....	419
UNCINO, DAY.....	409
UNCINO, FISCH.....	335
UNCINO, LUCAE.....	409
UNCINO, MCGEE.....	419
UNCINO, SMELLIE.....	605
UNCINO, WAGENER.....	409
UNI I COMBINAZIONE PER DIAGNOSTICA CON ILLUMINAZIONE STANDARD.....	13
UNI II COMBINAZIONE PER DIAGNOSTICA CON ILLUMINAZIONE STANDARD.....	14
UNI III COMBINAZIONE PER DIAGNOSTICA CON ILLUMINAZIONE STANDARD.....	15
UNIVERSAL FORBICI PER BENDAGGI.....	70
UNIVERSAL FORBICI PER FILO DI METALLO E LAMIERA.....	67
UNIVERSAL PINZA PER STERILIZZAZIONE.....	227
UNIVERSAL TREQUARTO.....	204
UNNA SCHIACCIACOMEDONI.....	608
URETROTOMO OTIS.....	553
US ARMY DIVARICATORE.....	141
USA PINZA ANATOMICA.....	81
V	
VACUMENTRO PER VUOTI DI SANGUE.....	295
VALLEIX ISTEROMETRO.....	586
VALVE CON ADATTATORI AL TELAIIO.....	194
VALVE, SCOVILLE.....	196
VAN BUREN CANDELETTA DILATATRICE.....	554
VAN BUREN TENAGLIA PER OSSA.....	249
VAN DOREN PINZA PER BIOPSIA.....	588
VANNAS FORBICI OCULISTICHE.....	79
VARADY STRUMENTO PER VARICI.....	202
VASSOIO PER PASTIGLIE.....	621
VERBRUGGE TENAGLIA PER OSSA.....	245
VERBRUGGE-MÜLLER ELEVATORE PER OSSA.....	286/2
VERESS AGO DI GUIDA.....	206
VIENNA SPECILLO DI GUIDA SCANALATO.....	221
VIRCHOW, COLTELLO PER CARTILAGINE E DISSEZIONE.....	48
VIRTUS(RALK) PINZA PER SCHEGGE.....	92
VOLKMANN CURETTA TAGLIANTE.....	251
VOLKMANN CURETTA TAGLIANTE.....	257
VOLKMANN DIVARICATORE.....	153
VOLKMANN DIVARICATORE.....	154
VOLKMANN DIVARICATORE.....	156
VOLTOLINI SPECILO NASALE.....	421
VU-MORE SPECILO VAGINALE.....	569
W	
WACHENFELDT PINZA PER AGRAFES.....	224
WADSWORTH-TODD CAUTERIO.....	378
WAGENER-MOSHER CANNULA TRACHEALE.....	477
WAGENR UNCINO.....	409
WAGNER FORBICI GINGIVALI.....	67
WAGNER PINZA TAGLIANTE PER LAMINECTOMIA.....	343
WAGNER SUPERCUT FORBICI.....	72
WALLICH CUCCHIAIO PER ABORTO.....	607
WALSHAM PINZA PER RADDRIZZARE IL SETTO NASALE.....	449
WALTON SGORBIA PER CORPI ESTRANEI.....	374
WALTON SCHIACCIACOMEDONI.....	608
WALTON SEGA TAGLIA ANELLI.....	297
WANGENSTEEN PINZA VASCOLARE.....	89
WANGENSTEEN PORT'AGHI.....	210
WARTENBERG ALGESIMETRO.....	25
WATSON DERMATOMO.....	50
WATSON-CHEYNE ELEVATORE.....	283
WATSON-CHEYNE SPECILLO.....	199
WATSON-WILLIAMS PINZA NASALE.....	428
WAUGH PINZA CHIRURGICA.....	83
WEBER ANSA PER CATERATTA.....	378
WEBER PINZA PER AORTA.....	501
WEBSTER PORT'AGHI.....	208
WECKER FORBICI OCULISTICHE.....	75
WECKER SPATOLA PER IRIDE.....	378
WEEK BLEFAROSTATO.....	370
WEIL-BLAKESLEY PINZA NASALE.....	426
WEITLANER DIVARICATORE.....	169
WEITLANER-WULLSTEIN DIVARICATORE.....	169
WELLER, FORBICI PER DISSEZIONE.....	53/2
WELLS CUCCHIAIO PER ENUCLEAZIONE.....	378
WERTHEIM FORBICI PER ISTERECTOMIA.....	63
WERTHEIM PINZA PER ISTERECTOMIA.....	124
WERTHEIM PINZA PER ISTERECTOMIA.....	128
WERTHEIM-CULLEN PINZA PER PEDUNCOLO RENALE.....	125
WESTCOTT FORBICI OCULISTICHE.....	75
WESTMACOTT PINZA NASALE PER TAMPONI.....	424
WESTON SERRANODI RETTALE.....	566
WHEELER COLTELLO LANCEOLARE.....	373
WHEELER SPATOLA PER CICLODIALISI.....	379
WHITE PINZA PER TONSILLE.....	467
WIEDER ABBASSALINGUA.....	452
WIENER RASPA NASALE.....	443
WIENER UNCINO PER IRIDE.....	375
WIGMORE COLTELLO PER GESSI.....	229
WIKSTROEM PINZA EMOSTATICA.....	117
WILDE SERRANODI.....	411
WILDE SERRANODI.....	433/2
WILDE(TROELTSCH) PINZA AURICOLARE.....	410
WILDER ANSA PER CATERATTA.....	378
WILLET MARTEL PINZA DA PRESA.....	110
WILLIAMS BLEFAROSTATO.....	370
WILLIAMS CACCIAVITE.....	323
WILLIAMS PINZA PER AFFERRARE INTESTINI.....	539
WILLIGER CURETTA TAGLIANTE.....	255
WILLIGER MARTELLO.....	271
WILLIGER PERIOSTOMO.....	276
WINTER PINZA PER ABORTO.....	606
WITTFNER PINZA PER BIOPSIA.....	589
WOLFF PINZA STRAPPAGESSI.....	233
WOODSON DURA DISSETTORE.....	333
WORST, SONDA.....	381
WRIGLEY FORCIPE.....	602
WULLSTEIN COLTELLO.....	418
WULLSTEIN DIVARICATORE.....	171
WULLSTEIN MANICO D'ASPIRAZIONE.....	338
WULLSTEIN MICRO PINZA AURICOLARE A CUCCHIAIO.....	416
WYLIE DILATATORE UTERINO.....	581
Y	
YANCOSKIE DIVARICATORE PER CHIRURGIA PLASTICA.....	198
YANKAUER DISSETTORE PER TONSILLE.....	465
YASARGIL CANNULA D'ASPIRAZIONE.....	337/2
YASARGIL CLIPS PER ANEURISMA.....	345 - 356
YASARGIL PINZA PER TUMORI.....	97
YASARGIL UNCINO GALEA.....	330
YEOMAN PINZA INTESTINALE PER BIOPSIA.....	566, 567
YOUNG BOOMERANG PER SUTURE.....	220
YOUNG DIVARICATORE PER LA PROSTATA.....	550
YOUNG PINZA TIRALINGUA.....	453
Z	
ZAUFAL ELEVATORE AURICOLARE.....	409
ZAUFAL-JANSEN ELEVATORE AURICOLARE.....	409
ZAUFAL-JANSEN PINZA SGORBIA.....	238
ZENKER DIVARICATORE.....	161
ZENKER PINZA EMOSTATICA.....	118
ZIEGLER BLEFAROSTATO.....	371
ZIEGLER COLTELLO LANCEOLARE.....	373
ZIEGLER COLTELLO PER IRIDE.....	372
ZIEGLER DILATATORE PER CANALE LACRIMALE.....	381
ZIEGLER SPECCHIO FRONTALE.....	21
ZIELKE SGORBIA.....	264
ZÖLLNER CANNULA D'ASPIRAZIONE.....	337/2



