

	<b>HADEO</b> INSTRUMENTE GERMANY	
		
		
	Neurochirurgie Neurosurgery Neurocirugia Neurochirurgia	





Wondershare PDFelement

**HADEO**  
INSTRUMENTE GERMANY

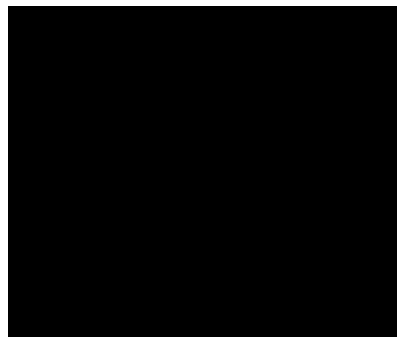

# HADEO

INSTRUMENTE GERMANY

Charrière (Ch) French (F)	Durchmesser in mm	Inches	Gauge (G)	Durchmesser in mm	Inches
1	0,33	0,013	35	0,13	0,005
2	0,67	0,025	34	0,18	0,007
3	1,00	0,039	33	0,20	0,008
4	1,33	0,051	32	0,23	0,009
5	1,67	0,065	31	0,25	0,010
6	2,00	0,0787	30	0,30	0,012
7	2,33	0,092	29	0,33	0,013
8	2,67	0,105	28	0,36	0,014
9	3,00	0,1181	27	0,41	0,016
10	3,33	0,131	26	0,46	0,018
11	3,67	0,144	25	0,51	0,020
12	4,00	0,1575		0,53	0,021
13	4,33	0,170	24	0,56	0,022
14	4,67	0,184	23	0,64	0,025
15	5,00	0,1968	22	0,71	0,028
16	5,33	0,210	21	0,81	0,032
17	5,67	0,223	20	0,89	0,035
18	6,00	0,2362		0,97	0,038
19	6,33	0,249	19	1,07	0,042
20	6,67	0,263	18	1,27	0,050
21	7,00	0,2756	17	1,50	0,059
22	7,33	0,288	16	1,65	0,065
23	7,67	0,302	15	1,83	0,072
24	8,00	0,3150	14	2,11	0,083
25	8,33	0,328	13	2,41	0,095
26	8,67	0,341	12	2,77	0,109
27	9,00	0,3543	11	3,05	0,120
28	9,33	0,367	10	3,40	0,134
29	9,67	0,380	9	3,76	0,148
30	10,00	0,3973	8	4,19	0,165
31	10,33	0,407	7	4,57	0,180
32	10,67	0,420	6	5,16	0,203
34	11,33	0,446			
36	12,00	0,4724			
38	12,67	0,494			
40	13,33	0,5199			
45	15,00	0,5905			

1 OZ	0,028 ml	35 OZ	1,0 l
5 OZ	0,140 ml	128 OZ	3,7 l
16 OZ	0,450 ml		

**HADEO**  
INSTRUMENTE GERMANY**GARANTIE / WARRANTY / GARANTIA / GARANZIA****GARANTIE**

Wir gewähren auf alle Hadeo Instrumente 3 Jahre Garantie. Voraussetzung ist der sach- und fachgerechte Einsatz der Instrumente. Von der Garantie sind Verschleißerscheinungen ausgeschlossen.

**WARRANTY**

Our Hadeo products are free from manufacturing defects in material and workmanship. We therefore give on all instruments a guarantee of 3 years provided that the instruments are maintained and cleaned properly and used normally for their intended purpose.

**GARANTIA**

Estamos convencidos de nuestra calidad y concedemos a todos los instrumentos de Hadeo 3 años de garantía contra cualquier defecto de fabricación, siempre y cuando se usen adecuadamente. De la garantía excluimos la manifestación de desgaste.

**GARANZIA**

Siamo convinti della nostra qualità e concediamo 3 anni di garanzia sulla funzione dei tutti gli strumenti Hadeo sotto la presupposizione che l'utilizzo è da esperto. Escluso della garanzia sono tracce di consumo.



## Arbeit sanweisung Aufbereitung (Reinigung) und Sterilisation von resterilisierbaren chirurgischen Instrumenten

DIN EN ISO 17664:2004 (D)

Hersteller:  
H A D E O Instrumente

Alle von Hadeo gelieferten wieder verwendbaren Instrumente wurden ausschließlich für den chirurgischen Gebrauch konstruiert und dürfen zu keinen anderen Zwecken benutzt werden. Unsachgemäße Handhabung und sorglose Pflege sowie zweckentfremdeter Gebrauch können zu vorzeitigem Verschleiß der Instrumente führen. Die Produkte sind bei der Auslieferung nicht sterilisiert.

### Reinigungsvorbereitung

Fabrikneue Instrumente müssen vor der ersten Anwendung den gesamten Aufbereitungsprozess durchlaufen. Instrumente unmittelbar nach Anlieferung aus den Folienverpackungen entnehmen und in trockenen Räumen bei gleichbleibender Raumtemperatur luftoffen lagern, um Kondensationsbildung zu vermeiden. Die Instrumente keinen Sonnenlichteinstrahlungen oder Dämpfen durch Chemikalien (Säuren oder scharfe Reinigern) aussetzen. Vor der ersten Sterilisation alle Schutzkappen und Folien vollständig entfernen und anschließend reinigen.

Gebrauchte Instrumente unmittelbar nach Beendigung des Eingriffs von Blut, Gewebe und Arzneimittel reinigen. Instrumente in eine freigegebene Lösung eines kombinierten Reinigungs- und Desinfektionsmittels, das keine proteinfixierende Wirkung besitzt, einlegen. Dosierung des Herstellers beachten. Nicht in NaCl Lösung einlegen, ansonsten Gefahr für Loch- bzw. Spannungsriss-Korrosion

Überfüllung von Instrumentensieben und Wasch-Trays vermeiden.

Gelenkinstrumente vor dem Aufbereiten öffnen. Zerlegbare Instrumente gemäß Bedienungsanleitung (Piktogramm) zur Reinigung zerlegen. Reinigungsgerechtes Zubehör verwenden. Für die manuelle Reinigung nie Metallbürsten oder Metallschwämme verwenden.

Spülmaschinen und Ultraschallanlagen nicht überladen. Spül- oder Schallschatten vermeiden. Dosierung, Einwirkzeit und Einwirktemperatur bei der Desinfektion und Reinigung unbedingt einhalten. Nach der Reinigung sorgfältig spülen. Möglichst vollentsalztes (demineralisiertes) Wasser verwenden.

Nach dem Spülen ausreichend trocknen.

Abgenutzte, korrodierte, deformierte, poröse oder anderweitig beschädigte Instrumente aussortieren.

Aus hygienischen Gründen müssen Instrumente, die zur Reparatur eingesandt werden komplett aufbereitet werden.

Gelenkinstrumente nach jeder Aufbereitung mit einem Pflegemittel auf Basis von Paraffinöl behandeln (gilt nicht für flexible Endoskope und Zubehör).

Funktionsprüfung in zusammengebautem Zustand durchführen.

Instrumente mit Rastensperre vor der Sterilisation nur im ersten Zahn schließen.

Als Sterilisationsverfahren empfehlen wir die Dampfsterilisation (üblicherweise mit Sattedampf bei 134° C)

Sterilisation ist kein Ersatz für Sauberkeit!

Die Broschüre "Instrumenten-Aufbereitung richtig gemacht" des Arbeitskreis Instrumenten-Aufbereitung dient als Anhalt.

Hadeo Instrumente

## IMPORTANT INFORMATION CONCERNING PREPARING AND STERILIZING SURGICAL INSTRUMENTS

Dear Sirs,  
please read the following instructions very carefully before using the instruments.

### 1. INITIAL USE

All instruments which are being used for the first time must be thoroughly cleaned, rinsed and then sterilized before using.

### 2. TREATING INSTRUMENTS AFTER USAGE

- a.) The instruments might be immediately thoroughly cleaned and disinfected. Please follow the manufacturer's instructions when using cleaning agents and disinfectants.
- b.) Instruments which may be dismantled must be cleaned and disinfected after being taken apart.
- c.) Cleaning may be carried out either manually or with a machine. Care should be taken that only cleaning agents and disinfectants are used, which are changed daily.
- d.) Following chemical disinfection and manual cleaning, all instruments must always be thoroughly rinsed under running water.
- e.) The temperature of water used in a machine for cleaning should not exceed 45°C.
- f.) Whether cleaning is carried out manually or by machine, we especially ask you to ensure that the correct dosage for cleaning solutions or the correct combination of disinfectant and cleaning solution, is employed. Similar importance should be applied to the length of time the agents require to perform properly and to the temperature set.
- g.) Hinged instruments should be opened before cleaning.
- h.) Please ensure that the perforated instrument trays, when loaded, do not exceed 10 kg in weight.
- i.) Please take care that when instruments are being cleaned they are arranged proper in a manne that fluids can circulate freely.
- j.) Deposits remaining after the cleaning process must be completely removed in the first rinse which now follows. The optimum temperature for final rinsing has proved to be between 70° and 90° C. Please use only purified water in this final cleaning stage.
- k.) The instruments must be carefully dried after cleaning and rinsing is completed.
- l.) Moving parts and the cutting edges of shears and scissors must be treated with preservatives which are both suitable and physiologically safe.

### 3. TESTING FOR CORRECT FUNCTIONING

- a.) Instruments must be carefully and thoroughly checked before every occasion that they are used.

- b.) After each time they are cleaned, the instruments must be macroscopically clean, i.e., visibly free from proteinbased residues and other soiling.
- c.) Care should be taken so that cracks, breakages and corrosion are noticed.
- d.) Instruments with flecks should be separated and taken out for special treatment.
- e.) All moving parts as well as working tips and blades should be checked with special care.
- f.) Checking should be carried out according to the extent to which the instruments will be used.
- g.) Instruments which are in any way defective or damaged should be immediately sorted out from the others.

### 4. STERILIZATION

- a.) All stainless steel surgical instruments supplied by us may be sterilized in an autoclave.
- b.) Please follow the manufacturer's operating instructions when using autoclave. All machines used must comply with all current quality and other standards.
- c.) Instruments are being sterilized/ autoclaved at a temperature of 134°C.
- d.) Sterilization packing material must comply with all current standards.
- e.) Instruments with ratchets or self-retaining mechanisms should be sterilized opened or in the first ratchet position.
- f.) Please ensure that perforated instrument trays, when loaded do not exceed 10 kg in weight.

### 5. IN GENERAL

- a.) All surgical instruments supplied by us have been thoroughly inspected before dispatch and leave our factory in perfect condition. Damage which can arise as a result of transporting, cleaning, preserving, sterilizing or storing, must be prevented.
- b.) Please handle surgical instruments always with the utmost care.
- c.) Instruments must be stored in a clean and dry place.
- d.) If you have any queries or problems please contact us at any time:

We should like to point out that, if the above-mentioned directions are not followed or the instruments supplied by us are not properly used, all guarantee claims become void and any consequences must be borne by yourselves.

## SUGERENCIAS PARA LA LIMPIEZA, ESTERILIZACIÓN Y MANTENIMIENTO DE INSTRUMENTOS QUIRÚRGICOS

### ENJUAGADO

Tras el uso enjuagar enseguida los instrumentos bajo un chorro de agua caliente (no hirviendo). El enjuagado debe servir para quitar los residuos de sangre, mucosas y tejidos.

### LIMPIEZA

Si la limpieza no se efectúa inmediatamente después del enjuagado, los instrumentos tienen que sumergirse en una solución de agua y detergente con PH neutro (7)

Para los instrumentos muy delicados (algunos tipos de porta agujas o tijeras se aconseja una limpieza manual: ver punto "C".

#### a.- Limpieza en la pila de ultrasonido

Los instrumentos tienen que estar en la pila el tiempo necesario recomendado por el fabricante para efectuar el ciclo del lavado, generalmente de 5 a 10 minutos.

Los instrumentos con bisagras o juntas (articulaciones) tienen que sumergirse en la pileta en posición abierta.

Asegurarse de que las hojas afiladas de las tijeras, bisturíes para gingivectomía, curetas, etc. no estén en contacto con otros instrumentos.

Todos los instrumentos deben estar completamente sumergidos en la solución de lavado.

No poner instrumentos de diferentes metales (acero inoxidable, instrumentos cromados, latón, etc.) en el mismo ciclo de lavado.

Cambiar a menudo la solución para el lavado, como mínimo todas las veces que lo recomienda el fabricante de la pila de ultrasonidos.

Enjuagar concienzudamente los instrumentos con agua corriente tras lavado con ultrasonidos para quitar los residuos de la solución de lavado.

#### b.- Limpieza con lavadora

Seguir las indicaciones del fabricante. Asegurarse de que los instrumentos hayan sido lubricados tras el último ciclo de lavado y antes del ciclo de esterilización.

#### c.- Limpieza manual

La mayor parte de los fabricantes de instrumentos indican el lavado con los ultrasonidos como el modo mejor y más eficaz para limpiar los instrumentos quirúrgicos, especialmente los que tienen bisagras, cierres y en general articulaciones. Si la limpieza con los ultrasonidos no es posible, se aconseja usar el método siguiente:

- Usar cepillos rígidos de plástico, nylon, etc.
- Cepillar concienzudamente los instrumentos más delicados y, si es posible, enjuagar, limpiar y esterilizar estos instrumentos separadamente.
- Verificar que toda la superficie de estos instrumentos esté limpia.
- Tras haber cepillado los instrumentos, enjuagarlos bajo el chorro de agua corriente.
- Durante el enjuagado abrir y cerrar las tijeras, las pinzas hemostáticas, los porta agujas y los demás instrumentos con bisagras o juntas y asegurarse de que las partes internas de las bisagras estén perfectamente enjuagadas como la superficie externa del instrumento.

### SECADO, LUBRIFICACIÓN E INSPECCIÓN

Tras las operaciones de limpieza y de enjuagado, los instrumentos quirúrgicos tienen que ser secados perfectamente.

Todos los instrumentos con juntas o bisagras (acción "metal contra metal") como tijeras, pinzas hemostáticas, porta agujas, fórceps de extracción, etc., tienen que ser lubricados. Se aconsejan lubricantes específicos para el instrumental quirúrgico. No usar aceites o lubricantes industriales.

A este punto es buena norma inspeccionar el estado de cada instrumento y verificar el funcionamiento según el uso específico. Controlar y asegurarse de que:

- Las hojas de las tijeras estén lisas de arriba abajo y de que, una vez cerradas, no hagan juego. Probar las tijeras cortando gasa muy fina. Tres cuartas parte de la hoja tienen que cortar la gasa sin retenerla.

- Las puntas de las pinzas estén al mismo nivel.
- Las pinzas hemostáticas y los porta agujas no dejen pasar la luz entre las puntas cuando estén cerradas, se abran y cierren fácilmente y que las bisagras no estén demasiado flojas.
- Controlar el desgaste de la porta agujas sobre la superficie interna de las puntas.
- Las cánulas metálicas de aspiración estén bien limpias en su interior.
- Los instrumentos cortantes y los bisturíes tengan las hojas bien afiladas y no estropeadas.

### ESTERILIZACIÓN EN AUTOCLAVE

Tras haber enjuagado, limpiado, secado, lubricado e inspeccionado los instrumentos, éstos pueden ser preparados para la esterilización separadamente o en serie.

Instrumentos individuales:

Las bolsas especiales monouso son el ideal para contener los instrumentos. Asegurarse de que las bolsas que contendrán los instrumentos con cierres y articulaciones (pinzas hemostáticas, porta agujas, etc.) sean lo bastante grandes como para contener los citados instrumentos en posición abierta.

Instrumentos en serie:

Poner los instrumentos en los especiales cestos o bandejas de acero inoxidable. Poner los instrumentos más pesados en la parte inferior cuando sean necesarias varias bandejas.

No cerrará nunca los instrumentos durante el ciclo en autoclave. Un instrumento cerrado no estará nunca bien esterilizado, ya que el vapor no puede penetrar en la parte de cierre a contacto "metal contra metal". En el instrumento podría además romperse en la parte de la bisagra a causa de la expansión del metal debida al calor durante el ciclo del autoclave.

No cargar demasiado la cámara del autoclave ya que algunos instrumentos podrían formar "zonas de sombra" sobre otros en los que el vapor no penetraría.

### ATENCIÓN

Al final del ciclo de esterilización - antes del ciclo de secado- abrir ligeramente la portezuela del autoclave y preceder con el ciclo desecado según las instrucciones del fabricante. Si la portezuela del autoclave se abre completamente antes del ciclo de secado, el aire frío de la habitación entraría en la cámara del autoclave causando la formación de condensación sobre los instrumentos y de consecuencia aparecerían las manchas de agua que vemos a menudo en los mismos.

### ESTERILIZACIÓN EN FRÍO:

La mayor parte de las soluciones para la esterilización en frío esterilizan los instrumentos completamente tras 10 horas de inmersión. Esta acción química prolongada puede ser más perjudicial para los instrumentos que el ciclo normal de 20 minutos en autoclave.

Si los instrumentos tienen necesidad de ser simplemente "desinfectados", el proceso en frío es adecuado, ya que la desinfección tiene lugar en 10 minutos solamente.

Recuerde bien la diferencia entre:

ESTÉRIL - término absoluto (ningún organismo logra sobrevivir) y

DESINFECTADO - perfectamente limpio.

Usen siempre la técnica más adecuada de esterilización/limpieza de los instrumentos según el uso que se haga posteriormente de ellos.

Recuerden que la esterilización de los instrumentos no sustituye la limpieza de los mismos.

Recomendamos no volver a usar ni esterilizar los artículos de un solo uso. Si se tratan en el modo correcto los instrumentos construidos con las modernas aleaciones inoxidables pueden durar muchos años.

**INDICAZIONI PER LA CURA, PULITURA E LA STERILIZZAZIONE  
DELLO STRUMENTARIO CHIRURGICO RISTERILIZZABILE****Misure preventive anticorrosione**

- 1) Raggruppare accuratamente gli strumenti correttamente confezionati e sterilizzati prima dell'operazione; selezionarli secondo l'intervento. Verificare sempre che la confezione esterna sia integra e che lo strumento stesso non sia danneggiato.
  - 2) Assicurarsi tramite l'indicatore di sterilizzazione collocato all'interno del vaglio che il contenuto sia stato sterilizzato.
  - 3) Disporre gli strumenti seguendo l'ordine di utilizzo durante l'operazione; lasciare gli strumenti non necessari nel vaglio; predisporre gli strumenti solo immediatamente prima dell'operazione.
  - 4) Nel corso dell'operazione rimuovere dagli strumenti sangue ed altri materiali biologici; dopo l'uso, riporre gli strumenti nel corretto alloggiamento.
  - 5) Risciacquare opportunamente gli strumenti cavi, al fine di evitare l'adesione di sangue e polvere d'osso.
  - 6) Per la pulitura degli strumenti utilizzare una soluzione lattata o una soluzione salina, ma non immergerli nelle suddette soluzioni.
  - 7) Iniziare l'operazione di pulitura subito dopo l'intervento. Strumenti utilizzati su pazienti con possibili infezioni: smaltire in modo analogo, eliminando sangue, polvere d'osso parti di tessuto in eccesso.
  - 8) Pulire gli strumenti in un luogo previsto nell'ambito della sala operatoria.
- Nel caso in cui gli strumenti vadano collocati direttamente nella centrale di sterilizzazione, è necessario dapprima coprirli, per evitare il rischio di contaminazione ai danni del personale o dell'ambiente circostante.

**Disinfezione**

Durante l'uso di disinfettanti chimici è necessario osservare scrupolosamente le indicazioni del produttore; utilizzare le soluzioni sempre previa diluizione. Nella fase termica di disinfezione con acqua bollente assicurarsi che l'acqua sia priva di corpi estranei.

**Pulitura**

Indipendentemente dal metodo utilizzato per la pulitura (meccanico o manuale) si raccomanda di verificare attentamente quale detergente vada utilizzato con ciascun metodo. Valori pH consigliati: tra 7,0 e 8,5.

**1) Pulitura meccanica**

Osservare scrupolosamente le istruzioni d'uso fornite dal produttore della macchina pulitrice. Predisporre gli

strumenti per la pulitura meccanica. Tutti gli strumenti appuntiti e delicati dovrebbero essere puliti manualmente.

Non sovraccaricare i vagli, mettere gli strumenti pesanti sul fondo del vaglio. Se necessario, immergere e risciacquare gli strumenti molto sporchi (strumenti cavi), prima di collocarli nella lavatrice.

**2) Pulitura ad ultrasuoni**

(fa parte dei metodi di pulitura meccanica)

Prima di inserire uno strumento nel bagno ad ultrasuoni, rimuovere i materiali organici in eccesso. I bagni ad ultrasuoni sono consigliati per le filettatrici o gli strumenti con solchi profondi. L'ultrasuono deve essere seguito da un programma di risciacquo normale.

**3) Pulitura manuale**

Richiede diverse spazzole in nylon, una canna da soffio ed un ugello da soffio/ un dispositivo ad aria compressa pulito, detergenti e solventi come per la pulitura meccanica.

Per gli additivi di pulitura osservare le indicazioni fornite dal produttore.

Per la pulitura degli strumenti dotati di cannula, passare più volte lo spazzolino di nylon attraverso la cannula eseguendo movimenti rotatori (non utilizzare spazzole in lana d'acciaio/metallo) fino alla completa rimozione dei residui eliminabili con questo metodo.

Soffiare poi con aria compressa nella cannula.

**4) Asciugatura**

Ogni strumento deve essere asciugato completamente sia internamente che esternamente per evitare la formazione di ruggine o malfunzionamenti.

**Indicazioni per la sterilizzazione della strumentazione**

Pulire immediatamente ed asciugare bene gli strumenti usati, non utilizzare detergenti e disinfettanti con additivi fortemente acidi o alcalini (ad es. soda, soda caustica o acidi)!

Sterilizzare la strumentazione solo a vapore A 134°! Prima della sterilizzazione, assicurarsi che gli strumenti siano perfettamente funzionanti ed integri. La sterilizzazione non sostituisce la pulitura.



DIAGNOSTIK DIAGNOSTICS DIAGNOSTICO DIAGNOSTICA	7 - 12
SKALPELLE SCALPELS BISTURIES BISTURI	13 - 18
SCHEREN SCISSORS TIJERAS FORBICI	19 - 48
PINZETTEN FORCEPS PINZAS PINZETTE	49 - 76
KLEMMEN CLAMPS PINZAS PINZE	77 - 92
NADELHALTER NEEDLE HOLDERS PORTA-AGUJAS PORT'AGHI	93 - 100
HAKEN HOOKS GANCHOS UNCINI	101 - 118
SPREIZER SPREADER SEPARADORES DIVARICATORI	119 - 160
ZANGEN FORCEPS PINZAS PINZE	161 - 174
SCHÄDELHALTER, DRAHTSÄGEN, TREPHINEN SKULL HOLDER, WIRE SAWS, TRÉPHINE CRÁNEO TITULAR, ALAMBRE DE SIERRAS, TREPANO SKULL TITOLARE, SEGHE A FILO, TRAPANO	175 - 182
LÖFFEL, MEISSEL CURETTES, CHISELS CUCHARILLAS, CINCELES CUCCHIAI, SCALPELLI	183 - 204
ELEVATORIEN, RASPATORIEN, DISSEKTOREN ELEVATORS, RASPATORIES, DISSECTORS ELEVADORES, PERIOSTÓTOMOS, DISECTORES ELEVATORI, PERIOSTOTOMI, DISSETTORI	205 - 228

SAUGROHRE SUCTION TUBES TUBOS DE ASPIRACIÓN TUBI D'ASPIRAZIONE	229 - 236
LAMINEKTOMIE LAMINECTOMY LAMINECTOMIA LAMINECTOMIA	237 - 246
MIKRO-RUNDGRIFFINSTRUMENTE MICRO INSTRUMENTS WITH ROUND HANDLE INSTRUMENTOS PARA MICROCIRUGÍA CON MANGOS REDONDOS STRUMENTI PER MICROCHIRURGIA CON MANICO ROTONDO	247 - 258
HYPOPHYSEKTOMIE HYPOPHYSECTOMY HIPOFISECTOMÍA IPOFISECTOMIA	259 - 272
HIRNSPATEL BRAIN SPATULAS ESPÁTULAS CEREBRALES SPATOLE CEREBRALI	273 - 280
STANZEN PUNCHES PINZAS SACABOCADO PINZE LAMINOTOMO	281 - 288
CLIPS CLIPS CLIPS CLIPS PER ANEURISMA	289 - 320
BOHRAPPARATE BONE HAND DRILLS PERFORADORES DE MANO PERFORATORI A MANO	321 - 326
BIPOLARE KOAGULATION BIPOLAR COAGULATION COAGULACIÓN BIPOLAR COAGULAZIONE BIPOLARE	327 - 336
SÄTZE SET SET SET	337 - 344
NUMMERNVERZEICHNIS NUMERICAL INDEX INDICE NUMERICO INDICE NUMERICO	345 - 353
ALPHABETISCHER INDEX ALPHABETICAL INDEX INDICE ALFABÉTICO INDICE ALFABETICO	355 - 377



Wondershare PDFelement

DIAGNOSTIK

DIAGNOSTICS

DIAGNÓSTICO

DIAGNOSTICA



[www.hadeo.co](http://www.hadeo.co)

**HADEO**  
INSTRUMENTE GERMANY

Perkussionshämmer  
Percussion Hammers  
Martillos de percusión  
Martelli da percussione



TAYLOR - USA Mod.  
03288-17 17 cm, 6 3/4"  
03288-20 20 cm, 8"



BABINSKY  
03292-22 22 cm, 8 3/4"



TROEMNER  
03294-24 24 cm, 9 1/2"



DEJERINE  
03304-20 20 cm, 8"



BERLINER  
03306-17 17 cm, 6 3/4"



BUCK  
03308-18 18 cm, 7"

**HADEO**  
INSTRUMENTE GERMANY

Hämmer  
Bone Hammers and Mallets  
Martillos y mazos  
Martelli



WILLIGER  
33691-34  
24 cm, 9 1/2"  
340 g



Ø 25 mm  
33694-03  
Ersatzbacken  
Nylon Caps  
Tapas de repuesto  
Battenti di ricambio

33694-01  
18,5 cm, 7 1/4"  
135 g

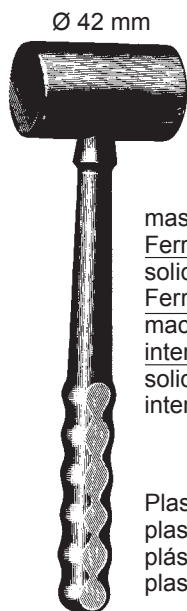

Ø 42 mm  
33695-40  
26 cm, 10 1/4"  
400 g

massiv, mit auswechselbaren  
Ferrozellbacken  
solid, with interchangeable  
Ferrozell jaws  
macizo, con tapas  
intercambiables de Ferrozell  
solido, con placche  
intercambiabili in Ferrozell

Plastik  
plastic  
plástico  
plastica



Ø 40 mm      Ø 30 mm  
33699-17  
26,5 cm, 10 1/2"  
530 g

**HADEO**  
INSTRUMENTE GERMANY

Hämmer  
Bone Hammers and Mallets  
Martillos y mazos  
Martelli

Ø 30 mm



33700-01-01  
Ersatzbacken  
Nylon Caps  
Tapas de repuesto  
Battenti di ricambio

33700-01  
24,5 cm, 9 3/4" 215 g

Ø 30 mm



COTTLE  
33700-05  
18 cm, 7" 240 g

Ø 40 mm



OMBREDANNE  
33700-07  
25 cm, 10" 700 g

Ø 35 mm



WAGNER  
33709-00  
24,5 cm, 9 3/4" 215 g

komplett mit:  
1 Paar Metallbacken 33709-01  
1 Paar Kunststoffbacken 33709-02  
1 Schlüssel 33709-03  
complete with:  
1 pair of metal discs 33709-01  
1 pair of plastic discs 33709-02  
1 wrench 33709-03  
completo con:  
1 par de mandibulas de metal 33709-01  
1 par de zapatos de plástico 33709-02  
1 llave 33709-03  
completo di battenti:  
1 paio di ganasce di metallo 33709-02  
1 paio di dischi di plastica 33709-02  
1 chiave 33709-03



**HADEO**  
INSTRUMENTE GERMANY

Prüf- und Meßinstrumente, Stimmgabel  
Examination and Measuring Instruments, Tuning Fork  
Instrumentos para exámenes y medición, Diapason  
Strumenti per esaminare e misurare, Diapason



03360-01  
Messbereich bis 150 mm  
measuring range up to 150 mm  
campo de medición hasta 150 mm  
calibro con scala fino a 150 mm



WARTENBERG  
03320-19  
19 cm, 7 1/2"

aus Stahl  
of steel  
de acero  
di acciaio



03350-15  
1,5 m 0.6"

mm & Inch

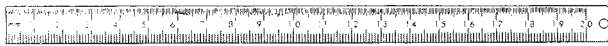

Metall		
03340-10	10 cm	4"
03340-15	15 cm	6"
03340-20	20 cm	8"
03340-30	30 cm	12"
03340-50	50 cm	20"



45075-00



Wondershare PDFelement

SKALPELLE

SCALPELS

BISTURÍES

BISTURI



[www.hadeo.co](http://www.hadeo.co)

**HADEO**  
INSTRUMENTE GERMANY

Skalpelli-Griffe  
Scalpel Handles  
Mangos de bisturíes  
Manici per lame bisturi

passend zu den Klängen  
for blades  
para las hojas  
per lame bisturi

Ⓐ No. 10, 11, 12, 13, 14, 15, 16, 17, 18, 19



07103-00

Fig. 3

Ⓐ



07103-01

Fig. 3 grad.

Ⓐ



07106-01  
14,5 cm 5 3/4"

Ⓐ

**HADEO**  
INSTRUMENTE GERMANYSkalpell-Griffe  
Scalpel Handles  
Mangos de bisturíes  
Manici per lame bisturipassend zu den Klängen  
for blades  
para las hojas  
per lame bisturi

Ⓐ No. 10, 11, 12, 13, 14, 15, 16, 17, 18, 19



07107-00

Fig. 7

Ⓐ



07107-01

Fig. 7K

Ⓐ



07109-10 10,0 cm, 4"

07109-13 13,0 cm, 5"

07109-15 15,5 cm, 6"



07161-00



07162-00



07165-00



07167-00

Packung mit 10 Stück  
box of 10  
en cajas de 10 pzas  
confezione di 10

**HADEO**  
INSTRUMENTE GERMANY

Skalpell-Griffe  
Scalpel Handles  
Mangos de bisturíes  
Manici per lame bisturi



CASPAR



93380-13  
135 mm / 5 1/2"



93380-15  
155 mm / 6"



93380-18  
180 mm / 7"



93380-20  
200 mm / 8"



LANDOLT  
93385-21 210 mm / 8 1/4"  
93385-25 250 mm / 10"

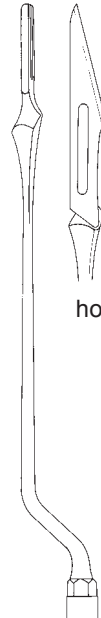

horizontal

LANDOLT  
93390-21 210 mm / 8 1/4"

**HADEO**  
INSTRUMENTE GERMANYKlingenbrecher  
Blade Breakers  
Rompe-hojas  
Rompi lama di rasoioTROUTMAN-CHRIS  
07290-09 9 cm, 3 1/2"HADEO  
07291-11 11 cm, 4 3/8"CASTROVIEJO  
07294-13 13 cm, 5 1/8"





Wondershare PDFelement

SCHEREN

SCISSORS

TIJERAS

FORBICI



[www.hadeo.co](http://www.hadeo.co)

# HADEO

INSTRUMENTE GERMANY

Chirurgische Scheren  
Operating Scissors  
Tijeras para cirugía  
Forbici per chirurgia



STANDARD —  
09102-13 13,0 cm, 5"  
09102-14 14,5 cm, 5 3/4"  
**09104-14 TC**  
09102-16 16,5 cm, 6 1/2"  
09102-18 18,5 cm, 7 1/4"



STANDARD —  
09110-13 13,0 cm, 5"  
09110-14 14,5 cm, 5 3/4"  
**09114-14 TC**  
09110-16 16,5 cm, 6 1/2"  
09110-18 18,5 cm, 7 1/4"



STANDARD —  
09120-13 13,0 cm, 5"  
09120-14 14,5 cm, 5 3/4"  
**09124-14 TC**  
09120-16 16,5 cm, 6 1/2"  
09120-18 18,5 cm, 7 1/4"



STANDARD —  
09103-13 13,0 cm, 5"  
09103-14 14,5 cm, 5 3/4"  
**09105-14 TC**  
09103-16 16,5 cm, 6 1/2"  
09103-18 18,5 cm, 7 1/4"



STANDARD —  
09111-13 13,0 cm, 5"  
09111-14 14,5 cm, 5 3/4"  
**09115-14 TC**  
09111-16 16,5 cm, 6 1/2"  
09111-18 18,5 cm, 7 1/4"



STANDARD —  
09121-13 13,0 cm, 5"  
09121-14 14,5 cm, 5 3/4"  
**09125-14 TC**  
09121-16 16,5 cm, 6 1/2"  
09121-18 18,5 cm, 7 1/4"



Chirurgische Scheren  
Operating Scissors  
Tijeras para cirugía  
Forbici per chirurgia

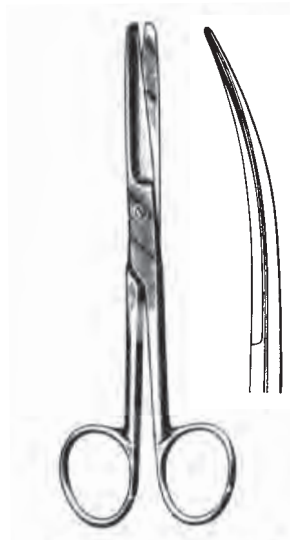

DEAVER  
09130-14 14 cm 09131-14  
5 1/2"

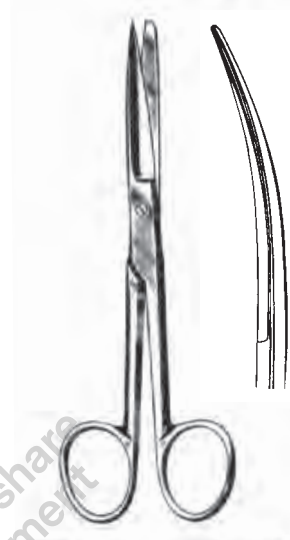

DEAVER  
09140-14 14 cm 09141-14  
5 1/2"

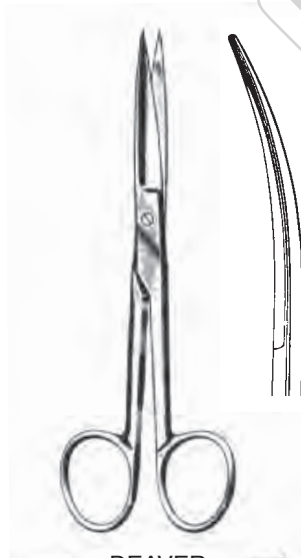

DEAVER  
09150-14 14 cm 09151-14  
5 1/2"



KELLY  
09540-16 09541-16  
09542-16 TC 09543-16 TC  
16 cm, 6 1/4"

**HADEO**  
INSTRUMENTE GERMANY

Präparierscheren  
Dissecting Scissors  
Tijeras de disección  
Forbici per dissezione



MAYO

09160-14	14,5 cm	09161-14
09164-14 TC	14,5 cm	09165-14 TC
	5 3/4"	
09160-17	17,0 cm	09161-17
09164-17 TC	17,0 cm	09165-17 TC
	6 3/4"	
09160-23	23,0 cm	09161-23
09164-23 TC	23,0 cm	09165-23 TC
	9"	



MAYO-STILLE

09170-15	15,0 cm	09171-15
09174-15 TC	15,0 cm	09175-15 TC
	6"	
09170-17	17,0 cm	09171-17
09174-17 TC	17,0 cm	09175-17 TC
	6 3/4"	
09170-21	21,0 cm	09171-21
09174-21 TC	21,0 cm	09175-21 TC
	8 1/4"	



LEXER

09190-16
09194-16 TC
16 cm, 6 1/4"



LEXER

09191-16
09195-16 TC
16 cm, 6 1/4"

**HADEO**  
 INSTRUMENTE GERMANY

 Präparierscheren  
 Dissecting Scissors  
 Tijeras de disección  
 Forbici per dissezione

**METZENBAUM**

09280-12 **09284-12 TC**  
 12 cm 4 3/4"

09280-15 **09284-15 TC**  
 15 cm 6"

09280-18 **09284-18 TC**  
 18 cm 7"

09280-20 **09284-20 TC**  
 20 cm 8"

09280-23 **09284-23 TC**  
 23 cm 9"

09280-25 **09284-25 TC**  
 25 cm 10"



**METZENBAUM**

09281-12 **09285-12 TC**  
 12 cm 4 3/4"

09281-15 **09285-15 TC**  
 15 cm 6"

09281-18 **09285-18 TC**  
 18 cm 7"

09281-20 **09285-20 TC**  
 20 cm 8"

09281-23 **09285-23 TC**  
 23 cm 9"

09281-25 **09285-25 TC**  
 25 cm 10"



**METZENBAUM FINO**

09282-15 **09286-15 TC**  
 15 cm 6"

09282-18 **09286-18 TC**  
 18 cm 7"

09282-20 **09286-20 TC**  
 20 cm 8"

09282-23 **09286-23 TC**  
 23 cm 9"

09282-25 **09286-25 TC**  
 25 cm 10"



**METZENBAUM FINO**

09283-15 **09287-15 TC**  
 15 cm 6"

09283-18 **09287-18 TC**  
 18 cm 7"

09283-20 **09287-20 TC**  
 20 cm 8"

09283-23 **09287-23 TC**  
 23 cm 9"

09283-25 **09287-25 TC**  
 25 cm 10"

**HADEO**  
INSTRUMENTE GERMANY

Präparierscheren  
Dissecting Scissors  
Tijeras de disección  
Forbici per dissezione



METZENBAUM BLACK

09281-15B  
14,5 cm, 5 3/4"

09281-18B  
18 cm, 7"

09281-20B  
20 cm, 8"

09283-18B  
18 cm, 7"

09283-20B  
20 cm, 8"

fein  
delicate  
fina  
delicate

fein  
delicate  
fina  
delicate



**HADEO**  
INSTRUMENTE GERMANY

Präparierscheren  
Dissecting Scissors  
Tijeras de disección  
Forbici per dissezione



BABY-METZENBAUM BLACK  
09283-15B  
14,5 cm, 5 3/4"



BLACK  
09371-11B  
11,5 cm, 4 1/2"

**HADEO**  
INSTRUMENTE GERMANY

Präparierscheren  
Dissecting Scissors  
Tijeras de disección  
Forbici per dissezione

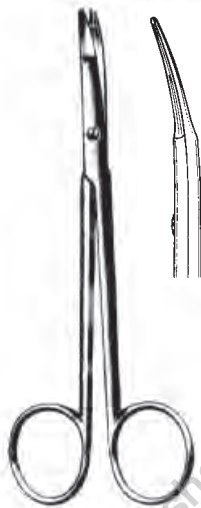

KILNER

- 09310-12 12 cm, 4 3/4" **09314-12 TC**
- 09310-15 15 cm, 6"
- 09312-12 12 cm, 4 3/4"



JAMESON WERBER  
09322-13 13 cm, 5"

fein  
delicate  
fina  
delicate



REYNOLDS —  
09321-15 15 cm, 6"  
09321-18 18 cm, 7"  
**09325-15 TC** 15 cm, 6"



Feine Scheren, Nerv-Präparierscheren  
 Delicate Scissor, Nerve Dissecting Scissors  
 Tijeras finas, Tijeras de diseccion para nervios  
 Forbici delicate per preparazione nervi

Iris - Standard



abgewinkelt  
 angled  
 angulada  
 angolata

09340-09	9 cm, 3 1/2"	09341-09	09346-11	11 cm, 4 3/8"
09340-10	10 cm, 4"	09341-10		
09340-11	11 cm, 4 3/8"	09341-11		
<b>09344-11 TC</b>	11 cm, 4 3/8"	<b>09345-11 TC</b>		



09582-15 09583-15  
 15 cm, 6"



TOENNIS-ADSON  
 09610-18  
 18 cm, 7"

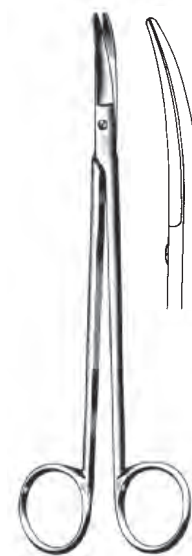

TOENNIS-ADSON  
 09611-18  
 18 cm, 7"

**HADEO**  
INSTRUMENTE GERMANY

Feine Scheren  
Delicate Scissors  
Tijeras finas  
Forbici delicate



GRADLE  
09350-09 09351-09  
9,5 cm, 3 3/4"



09352-09 09353-09  
9,5 cm, 3 3/4"



09360-11



09362-11



STEVENS  
11 cm, 4 3/8"



09361-11



09363-11

**HADEO**  
INSTRUMENTE GERMANY

Gefäßscheren  
Vascular Scissors  
Tijeras vasculares  
Forbici vascolari



POTTS-DE MARTEL  
09473-21  
21 cm, 8 1/4"



MILLS  
09474-22  
22 cm, 8 3/4"



DIETRICH



25°

09475-25  
**09476-25 TC**  
18 cm, 7"



45°

09475-45  
**09476-45 TC**  
18 cm, 7"



60°

09475-60  
**09476-60 TC**  
17,5 cm, 6.9"



90°

09475-90  
**09476-90 TC**  
17 cm, 6 3/4"



125°

09475-00  
**09476-00 TC**  
17 cm, 6 3/4"

**HADEO**  
INSTRUMENTE GERMANY

Gefäßscheren  
Vascular Scissors  
Tijeras vasculares  
Forbici vascolari



DIETRICH  
09477-01  
17 cm, 6 3/4"



POTTS-SMITH  
09480-18  
18,5 cm, 7 1/4"

Scheren mit Hartmetalleinsätzen  
Scissors with Tungsten Carbide  
Tijeras con carburo de tungsteno  
Forbici con carburo di tungsteno

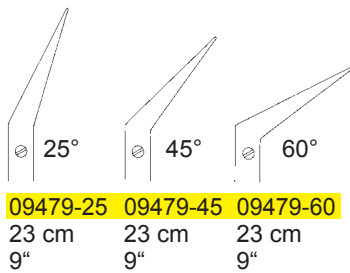
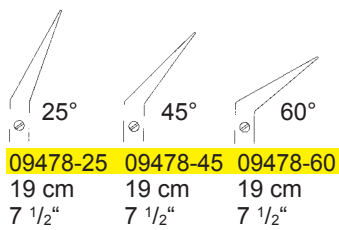

DE BAKHEY  
(POTTS-SMITH)

**HADEO**  
INSTRUMENTE GERMANY

Gefäßscheren  
Vascular Scissors  
Tijeras vasculares  
Forbici vascolari

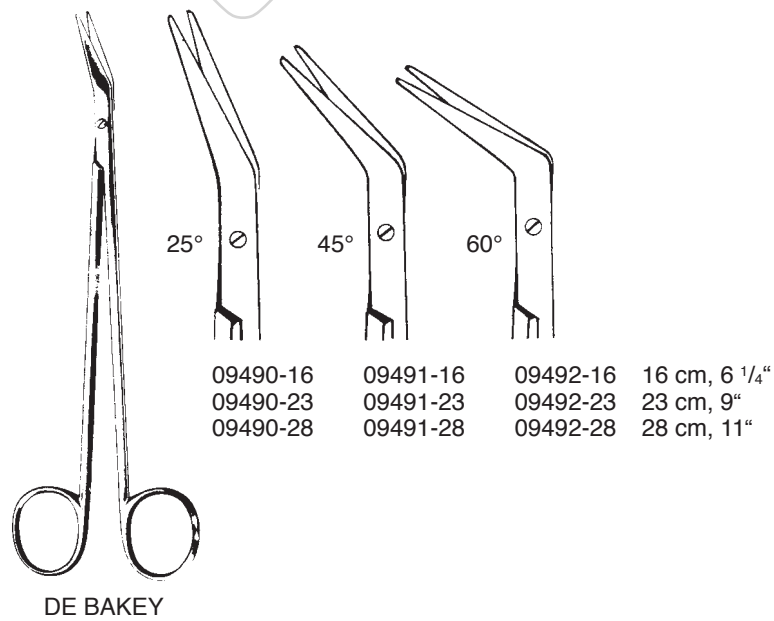
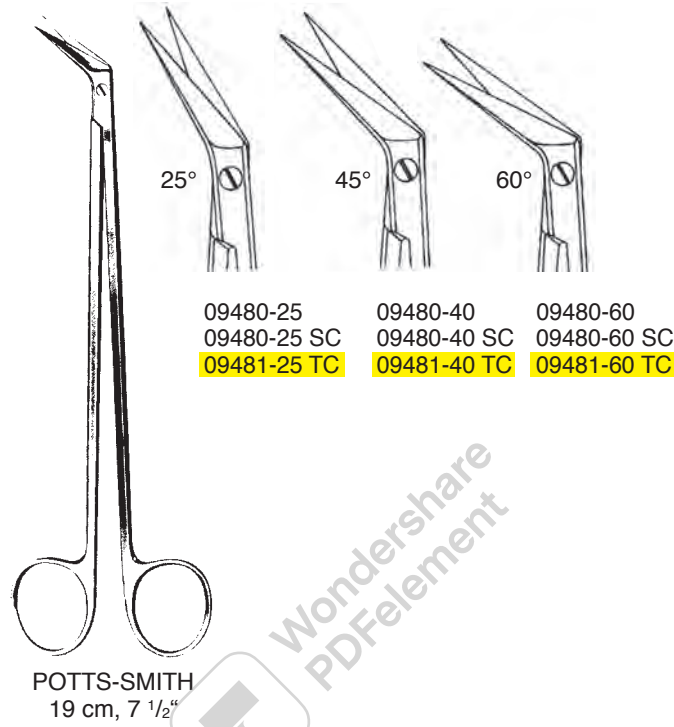

**HADEO**  
INSTRUMENTE GERMANY

Gefäßscheren  
Vascular Scissors  
Tijeras vasculares  
Forbici vascolari

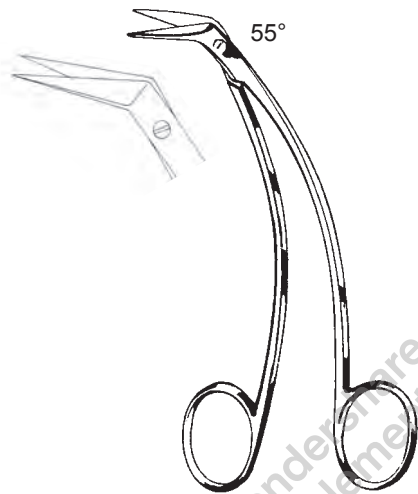

FAVALORO  
09496-15 15 cm, 5.9"

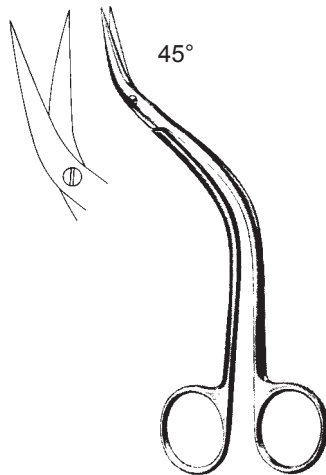

DE BAKEY  
09497-15 15,5 cm, 6"



**HADEO**  
INSTRUMENTE GERMANY

Trigeminusscheren  
Trigeminal Scissors  
Tijera para trigemino  
Forbici per trigemino



STRULLY  
09601-22  
22 cm, 8 3/4"



DANDY  
09617-17  
17 cm, 6 3/4"



gezahnt  
toothed  
dentada  
dentate

OLIVECRONA  
09620-23  
23 cm, 9"

**HADEO**  
INSTRUMENTE GERMANY

Duraschere  
Dura Scissors  
Tijeras para duramadre  
Forbici per dura-madre



SCHMIEDEN-TAYLOR  
09619-17  
17 cm, 6 <sup>3</sup>/<sub>4</sub>"

Draht-, Bleischere  
Wire and plate scissors  
Tijeras para alambre y láminas  
Forbici per filo di metallo e lamiera



UNIVERSAL  
09831-12 12 cm, 4 <sup>3</sup>/<sub>4</sub>"  
09835-12 TC 12 cm, 4 <sup>3</sup>/<sub>4</sub>"

**HADEO**  
INSTRUMENTE GERMANY

Mikro-Federscheren, bajonettförmig  
Micro Scissors (Spring Type), bayonet-shaped  
Micro tijeras, forma bayoneta  
Micro forbici a baionetta



190 mm  
7 1/2"

10120-18



10121-18



10122-18



10123-18



**HADEO**  
INSTRUMENTE GERMANY

Mikro-Federscheren  
Micro Scissors (Spring Type)  
Micro tijeras  
Micro forbici

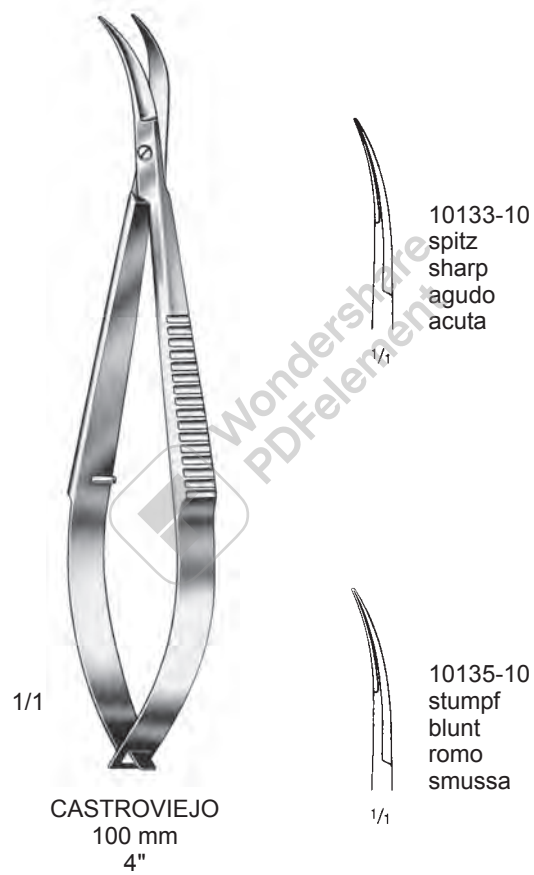

**HADEO**  
INSTRUMENTE GERMANY

Mikro-Federscheren  
Micro Scissors (Spring Type)  
Micro tijeras  
Micro forbici

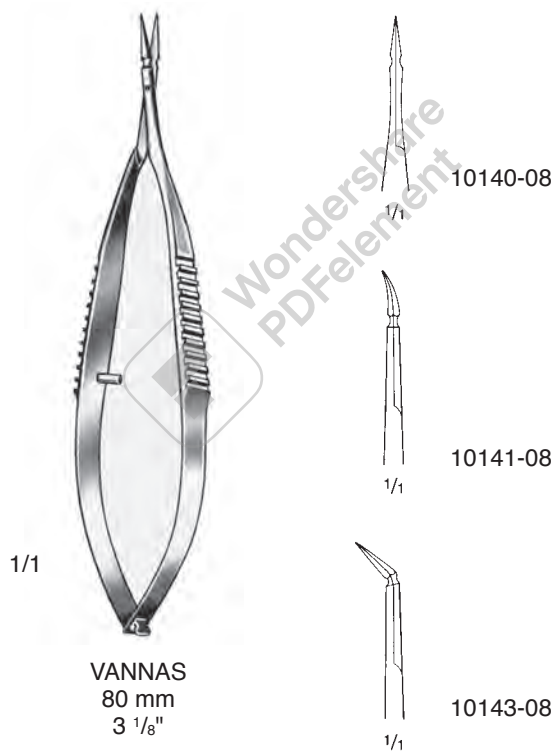

**HADEO**  
INSTRUMENTE GERMANY

Mikro Scheren  
Micro Scissors  
Micro tijeras  
Micro Forbice



10 mm

11 cm  
4 3/8"

10202-11

10203-11

14,5 cm  
5 3/4"

10202-14

10202-14T

10203-14

10203-14T

18 cm  
7"

10202-18

10202-18T

10203-18

10203-18T

21 cm  
8 1/4"

10202-21

10202-21T

10203-21

10203-21T

23 cm  
9"

10202-23

10203-23

T = Titan, titanium, titanio, titanio

**HADEO**  
INSTRUMENTE GERMANY

Mikro Scheren  
Micro Scissors  
Micro tijeras  
Micro Forbice



18 cm 7"



25°

10220-25

10220-25T



45°

10220-45

10220-45T



60°

10220-60

10220-60T



90°

10220-90

10220-90T



125°

10220-00

10220-00T

T = Titan, titanium, titanio, titanio

**HADEO**  
INSTRUMENTE GERMANY

Mikro Scheren  
Micro Scissors  
Micro tijeras  
Micro Forbice

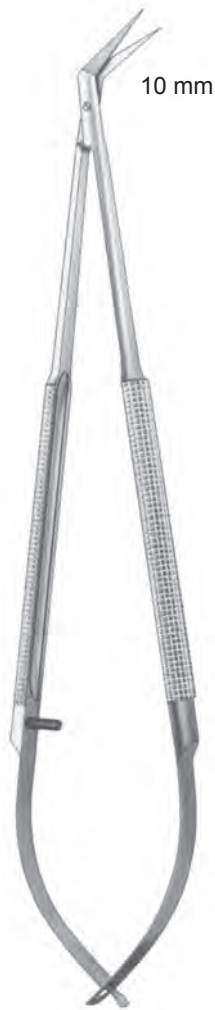

	11 cm 4 3/8"	14,5 cm 5 3/4"	18 cm 7"	21 cm 8 1/4"	23 cm 9"
25°	10226-11	10226-14	10226-18 <b>10226-18T</b>	10226-21	10226-23
45°	10227-11	10227-14	10227-18 <b>10227-18T</b>	10227-21	10227-23
60°	10228-11	10228-14	10228-18 <b>10228-18T</b>	10228-21	10228-23
90°	10229-11	10229-14	10229-18 <b>10229-18T</b>	10229-21	10229-23
125°	10230-11	10230-14	10230-18 <b>10230-18T</b>	10230-21	10230-23

T = Titan, titanium, titanio, titanio



**HADEO**  
INSTRUMENTE GERMANY

Mikro-Federscheren, bajonettförmig  
Micro Scissors (Spring Type), bayonet-shaped  
Micro tijeras, forma bayoneta  
Micro forbici a baionetta



YASARGIL



93094-16 165 mm / 6 1/2"  
93094-20 200 mm / 8"



93095-16 165 mm / 6 1/2"  
93095-20 200 mm / 8"



93097-20 200 mm / 8"



93098-20 200 mm / 8"  
Präparierscheren  
Dissecting Scissors  
Tijeras de disección  
Forbici per dissezione



93099-20 200 mm / 8"  
Präparierscheren  
Dissecting Scissors  
Tijeras de disección  
Forbici per dissezione

**HADEO**  
INSTRUMENTE GERMANY

Mikro-Federscheren, bajonettförmig  
Micro Scissors (Spring Type), bayonet-shaped  
Micro tijeras, forma bayoneta  
Micro forbici a baionetta



93100-22 225 mm / 9"  
93101-22 225 mm / 9"

YASARGIL  
Schneiden gezahnt  
toothed blades  
ramas dentadas  
tagli dentellati



93102-22 225 mm / 9" VANNAS



93103-22 225 mm / 9"  
93103-24 245 mm / 9 3/4"

YASARGIL



93105-22 225 mm / 9" VANNAS



93107-22 225 mm / 9" YASARGIL



93108-22 225 mm / 9" YASARGIL

Präparierscheren  
Dissecting Scissors  
Tijeras de disección  
Forbici per dissezione



93109-22 225 mm / 9" YASARGIL

Präparierscheren  
Dissecting Scissors  
Tijeras de disección  
Forbici per dissezione

**HADEO**  
INSTRUMENTE GERMANY

Mikro-Federschere, bajonettförmig  
Micro Scissors (Spring Type), bayonet-shaped  
Micro tijeras, forma bayoneta  
Micro forbici a baionetta

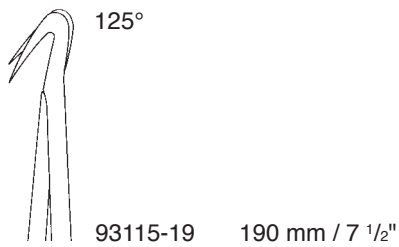
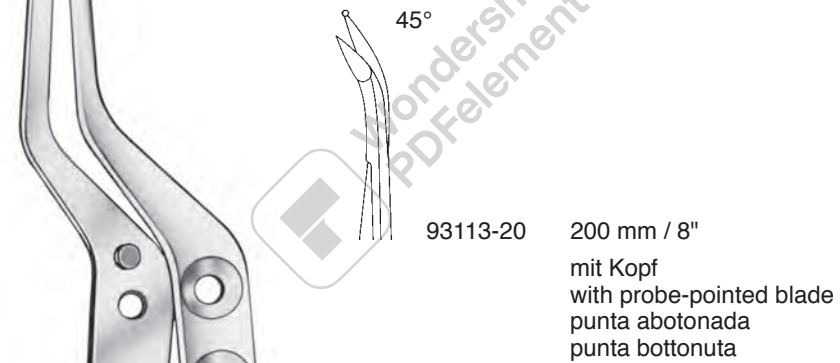
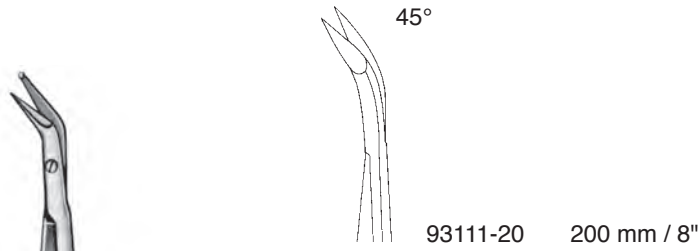



NAGEL





Mikro-Federscheren  
 Micro Scissors (Spring Type)  
 Micro tijeras  
 Micro forbici

	93180-12	120 mm / 4 3/4"	
	93180-16	160 mm / 6 1/4"	
	93182-16	160 mm / 6 1/4"	MILLES!
			Schneiden gezahnt ← toothed blades ramas dentadas tagli dentellati
	93180-18	185 mm / 7 1/4"	YASARGIL

	93181-12	120 mm / 4 3/4"	
	93181-16	160 mm / 6 1/4"	
	93183-16	160 mm / 6 1/4"	MILLES!
			Schneiden gezahnt ← toothed blades ramas dentadas tagli dentellati
	93181-18	185 mm / 7 1/4"	JACOBSON

	93190-12	120 mm / 4 3/4"	VANNAS
	93190-16	160 mm / 6 1/4"	

	93191-12	120 mm / 4 3/4"	VANNAS
	93191-16	160 mm / 6 1/4"	

	93192-13	130 mm / 5 1/8"	BIEMER
			Venenschere Vein Scissors Tijera para venas Forbice per vene

	93193-12	120 mm / 4 3/4"	VANNAS
---	----------	-----------------	--------

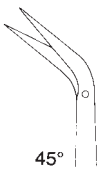
	93195-18	185 mm / 7 1/4"	POTTS-YASARGIL
			45°





Mikro-Federscheren  
 Micro Scissors (Spring Type)  
 Micro tijeras  
 Micro forbici

- |          |                   |          |
|----------|-------------------|----------|
| 93210-12 | 120 mm / 4 3/4"   |          |
| 93210-16 | 160 mm / 6 1/4"   |          |
| 93212-16 | 160 mm / 6 1/4"   | MILLES   |
|          | Schneiden gezahnt | ←        |
|          | toothed blades    |          |
|          | ramas dentadas    |          |
|          | tagli dentellati  |          |
| 93210-18 | 185 mm / 7 1/4"   | YASARGIL |



- |          |                   |          |
|----------|-------------------|----------|
| 93211-12 | 120 mm / 4 3/4"   |          |
| 93211-16 | 160 mm / 6 1/4"   |          |
| 93213-16 | 160 mm / 6 1/4"   | MILLES   |
|          | Schneiden gezahnt | ←        |
|          | toothed blades    |          |
|          | ramas dentadas    |          |
|          | tagli dentellati  |          |
| 93211-18 | 185 mm / 7 1/4"   | JACOBSON |
| 93216-12 | 120 mm / 4 3/4"   | VANNAS   |
| 93216-16 | 160 mm / 6 1/4"   |          |



- |          |                 |        |
|----------|-----------------|--------|
| 93217-12 | 120 mm / 4 3/4" | VANNAS |
| 93217-16 | 160 mm / 6 1/4" |        |



- |          |                   |        |
|----------|-------------------|--------|
| 93218-13 | 130 mm / 5 1/8"   | BIEMER |
|          | Venenschere       |        |
|          | Vein Scissors     |        |
|          | Tijera para venas |        |
|          | Forbice per vene  |        |

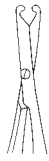

- |          |                 |        |
|----------|-----------------|--------|
| 93219-12 | 120 mm / 4 3/4" | VANNAS |
|----------|-----------------|--------|



- |          |                 |                |
|----------|-----------------|----------------|
| 93221-18 | 185 mm / 7 1/4" | POTTS-YASARGIL |
|----------|-----------------|----------------|

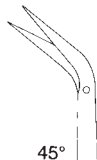

45°



**HADEO**  
INSTRUMENTE GERMANY

Mikro-Federscheren  
Micro Scissors (Spring Type)  
Micro tijeras  
Micro forbici



93270-14 145 mm / 5 3/4"  
93270-18 180 mm / 7"



93270-23 230 mm / 9"



93271-14 145 mm / 5 3/4"  
93271-18 180 mm / 7"



93273-14 145 mm / 5 3/4"  
93273-18 180 mm / 7"

Mikro Präparierscheren  
Micro dissecting Scissors  
Micro tijeras de disección  
Micro forbici per dissezione

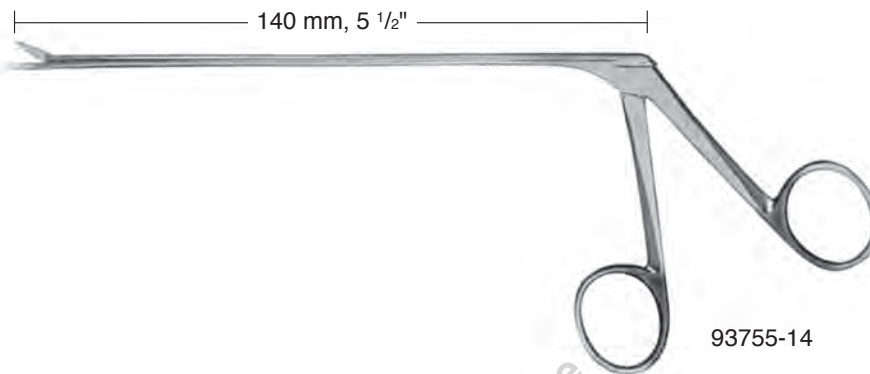
**HADEO**  
INSTRUMENTE GERMANYTumorschere  
Tumor scissors  
Tijera para tumores  
Forbice per tumori

93755-14

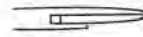
gerade  
straight  
recta  
retta

93756-14

rechts gebogen  
curved right  
curva hacia la derecha  
curva a destra

93757-14

links gebogen  
curved left  
curva hacia la izquierda  
curva a sinistra

**HADEO**  
INSTRUMENTE GERMANY

Rippenscheren  
Rib Shears  
Costótomos  
Costotomi



SAUERBRUCH  
57131-26  
26 cm, 10 1/4"



GIERTZ-STILLE  
57137-27  
27 cm, 10 1/2"



SAUERBRUCH-FREY  
57141-36  
36 cm, 14.2"



Wondershare PDFelement

PINZETTEN

FORCEPS

PINZAS

PINZETTE



[www.hadeo.co](http://www.hadeo.co)

**HADEO**  
INSTRUMENTE GERMANY

Anatomische und chirurgische Pinzetten  
Dressing and Tissue Forceps  
Pinzas de disección, sin/con dientes  
Pinze per dissezione, chirurgiche/anatomiche



1x2

## POTTS-SMITH

11112-18	18 cm, 7"	11116-18 TC
11112-21	21 cm, 8 1/4"	11116-21 TC
11112-25	25 cm, 10"	11116-25 TC

## POTTS-SMITH

11126-18	18 cm, 7"
11126-21	21 cm, 8 1/4"
11126-25	25 cm, 10"

Anatomische und chirurgische Pinzetten  
Dressing and Tissue Forceps  
Pinzas de disección, sin/con dientes  
Pinze per dissezione, chirurgiche/anatomiche



ADSON  
11170-12 12,0 cm, 4 3/4"  
11170-15 15,0 cm, 6"



ADSON  
11174-12 TC 12,0 cm, 4 3/4"  
11174-15 TC 15,0 cm, 6"



ADSON micro  
11176-12 12,0 cm, 4 3/4"  
11176-15 15,0 cm, 6"



ADSON-DE BAKEY atrauma  
11177-12  
12,0 cm, 4 3/4"



ADSON  
11178-12  
12,0 cm, 4 3/4"



ADSON  
11179-12  
12 cm, 4 3/4"

**HADEO**  
INSTRUMENTE GERMANY

Anatomische und chirurgische Pinzetten  
Dressing and Tissue Forceps  
Pinzas de disección, sin/con dientes  
Pinze per dissezione, chirurgiche/anatomiche



1x2

ADSON

11180-12 12,0 cm, 4 3/4"  
11180-15 15,0 cm, 6"



1x2

ADSON

11181-12 TC 12,0 cm, 4 3/4"  
11181-15 TC 15,0 cm, 6"



1x2

ADSON micro

11186-12 12,0 cm, 4 3/4"  
11186-15 15,0 cm, 6"



1x2

ADSON

11187-12  
12 cm, 4 3/4"



7x7

ADSON-BROWN

11188-12 12,0 cm, 4 3/4"  
11188-15 15,0 cm, 6"  
11189-12 TC 12,0 cm, 4 3/4"

**HADEO**  
INSTRUMENTE GERMANY

Anatomische und chirurgische Pinzetten  
Dressing and Tissue Forceps  
Pinzas de disección, sin/con dientes  
Pinze per dissezione, chirurgiche/anatomiche



9x9



1x2

**BROWN**

- 11189-15 15,0 cm, 6"
- 11189-20 20,0 cm, 8"
- 11189-25 25,0 cm, 10"

**WAUGH**

- 11187-18 18 cm, 7"
- 11187-20 20 cm, 8"
- 11187-25 25 cm, 10"
- 11187-30 30 cm, 11 3/4"



11220-17  
11224-17 TC



11221-17



11222-17  
11225-17 TC

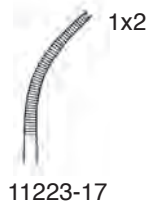

11223-17

**CUSHING**  
17 cm, 6 3/4"

**CUSHING**  
17 cm, 6 3/4"

**HADEO**  
INSTRUMENTE GERMANY

Anatomische und chirurgische Pinzetten  
Dressing and Tissue Forceps  
Pinzas de disección, sin/con dientes  
Pinze per dissezione, chirurgiche/anatomiche



BROPHY  
11231-20  
20,0 cm, 8"



BROPHY  
11233-20  
20,0 cm, 8"



11234-20



11235-20



BROPHY  
20,0 cm, 8"



ADLERKREUTZ  
11236-15 15,0 cm, 6"  
11236-20 20,0 cm, 8"

**HADEO**  
INSTRUMENTE GERMANY

Anatomische und chirurgische Pinzetten  
Dressing and Tissue Forceps  
Pinzas de disección, sin/con dientes  
Pinze per dissezione, chirurgiche/anatomiche



DUEHRSEN  
11237-20  
20 cm, 8"



McINDOE  
11257-15  
15,0 cm, 6"



McINDOE  
11258-15 15,0 cm, 6"  
11259-15 TC 15,0 cm, 6"



Anatomische und chirurgische Pinzetten  
 Dressing and Tissue Forceps  
 Pinzas de disección, sin/con dientes  
 Pinze per dissezione, chirurgiche/anatomiche



SEMKEN  
 11260-12 12,5 cm, 5"  
 11260-15 15,5 cm, 6"  
 11261-15 TC 15,5 cm, 6"



SEMKEN 1x2  
 11270-12 12,5 cm, 5"  
 11270-15 15,5 cm, 6"  
 11271-15 TC 15,5 cm, 6"  
 11271-18 TC 18,0 cm, 7"



GILLIES 1x2  
 11272-15 15,5 cm, 6"  
 11273-15 TC 15,5 cm, 6"



15,5 cm, 6"



11274-06  
 0,6 mm



11274-08  
 0,8 mm



11274-10  
 1,0 mm



GERALD  
 11302-17 17,5 cm, 6.9"  
 11302-23 23,0 cm, 9"  
 11304-17 TC 17,0 cm, 6 3/4"



GERALD  
 11303-17  
 17,5 cm, 6.9"



**HADEO**  
INSTRUMENTE GERMANY

Anatomische und chirurgische Pinzetten  
Dressing and Tissue Forceps  
Pinzas de disección, sin/con dientes  
Pinze per dissezione, chirurgiche/anatomiche



GERALD  
11305-17  
17,5 cm, 6.9"



GERALD  
11310-17 17,5 cm, 6.9"  
11312-17 TC 17,5 cm, 6.9"



GERALD  
11311-17  
17,5 cm, 6.9"



CUSHING-TAYLOR  
11312-18 TC 18,5 cm, 7 1/4"



GERALD  
11313-17 17,5 cm, 6.9"

**HADEO**  
INSTRUMENTE GERMANY

Anatomische und chirurgische Pinzetten  
Dressing and Tissue Forceps  
Pinzas de disección, sin/con dientes  
Pinze per dissezione, chirurgiche/anatomiche

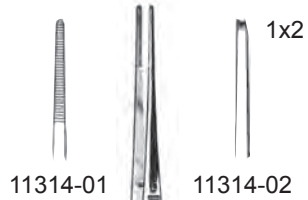

TAYLOR  
17 cm, 6 3/4"

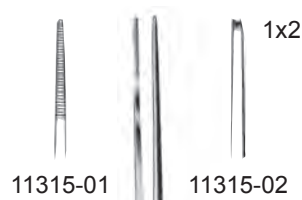

TAYLOR  
17 cm, 6 3/4"



WANGENSTEEN  
11324-23 23 cm 9"



WANGENSTEEN  
11325-15 TC 15 cm, 6"  
11325-23 TC 23 cm, 9"  
11325-25 TC 25 cm, 10"



MAYO  
11326-23 23 cm, 9"

**HADEO**  
INSTRUMENTE GERMANY

Hirnspatelpinzette  
Brain Spatula Forceps  
Pinza-espátula cerebral  
Pinze a spatola cerebrale

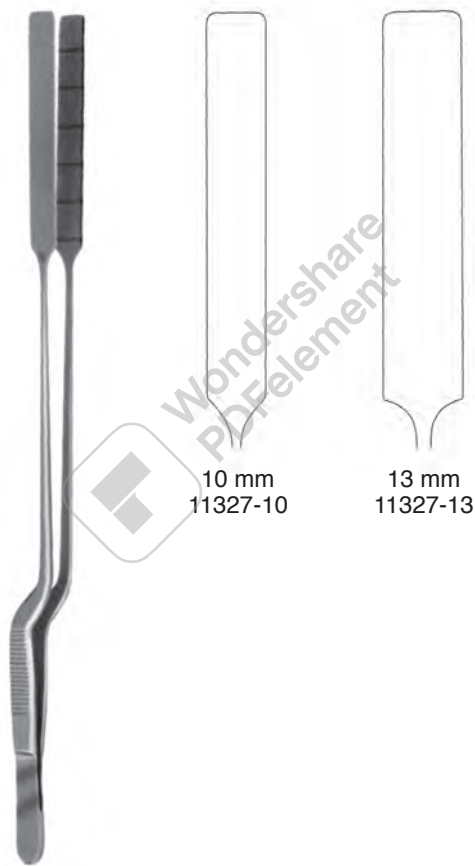

SCOVILLE  
22 cm, 8 <sup>3</sup>/<sub>4</sub>"

**HADEO**  
INSTRUMENTE GERMANY

Uhrmacherpinzette  
Jeweler Type Forceps  
Pinzas de relojero  
Pinze da orologiaio

Fig. 1



11401-01  
12 cm, 4 3/4"

Fig. 3



11403-03  
12 cm, 4 3/4"

Fig. 3c



11403-04  
11 cm, 4 3/8"

Fig. 4



11404-04  
11 cm, 4 3/8"

Fig. 5



11405-05  
11 cm, 4 3/8"

Fig. 7



11407-07  
12 cm, 4 3/4"

**HADEO**  
INSTRUMENTE GERMANY

Gefäßdilatoren  
Vessel dilators  
Dilatadores vasculares  
Pinze dilatatori vascolari



0,2 mm

0,3 mm

0,2 mm

0,3 mm



11408-01  
11 cm, 4 3/8"

11408-02  
11 cm, 4 3/8"

11408-03  
13,5 cm, 5 1/4"

11408-04  
13,5 cm, 5 1/4"

Juwelierpinzette/Uhrmacherpinzette  
Jeweler's Forceps/Jeweler Type Forceps  
Pinzas para joyero/Pinzas de relojero  
Pinze per gioielliere/Pinze da orologiaio



11409-11



11410-11



11,5 cm, 4 1/2"



11 cm, 4 3/8"

0,3 mm  
45°

11411-11

**HADEO**  
INSTRUMENTE GERMANY

Mikro Knüpfpinzetten  
Micro Suture Tying Forceps  
Micro Pinzas para ligaduras  
Micro Pinze per legature



	0,3 mm	0,8 mm
12 cm, 4 3/4"	12102-12 12102-12D	
15 cm, 6"	12104-15 12104-15D	
18 cm, 7"		12108-18 12108-18D
21 cm, 8 1/4"		12102-21 12102-21D
23 cm, 9"		12102-23 12102-23D



	0,3 mm	0,8 mm
12 cm, 4 3/4"	12103-12 12103-12D	
15 cm, 6"	12103-15 12103-15D	
18 cm, 7"		12109-18 12109-18D
21 cm, 8 1/4"		12109-21 12109-21D
23 cm, 9"		12109-23 12109-23D



	0,3 mm	0,3 mm	0,4 mm	0,4 mm	0,8 mm	0,8 mm
15 cm, 6"	12090-15D	12091-15D				
18 cm, 7"	12090-18D	12091-18D				
21 cm, 8 1/4"	12090-21D	12091-21D				
23 cm, 9"	12090-23D	12091-23D				



D = mit diamantiertem Maul  
with diamond jaw  
con boca de diamante  
con morso diamantato

**HADEO**  
INSTRUMENTE GERMANY

Mikro Knüpfpinzetten  
Micro Suture Tying Forceps  
Micro Pinzas para ligaduras  
Micro Pinze per legature

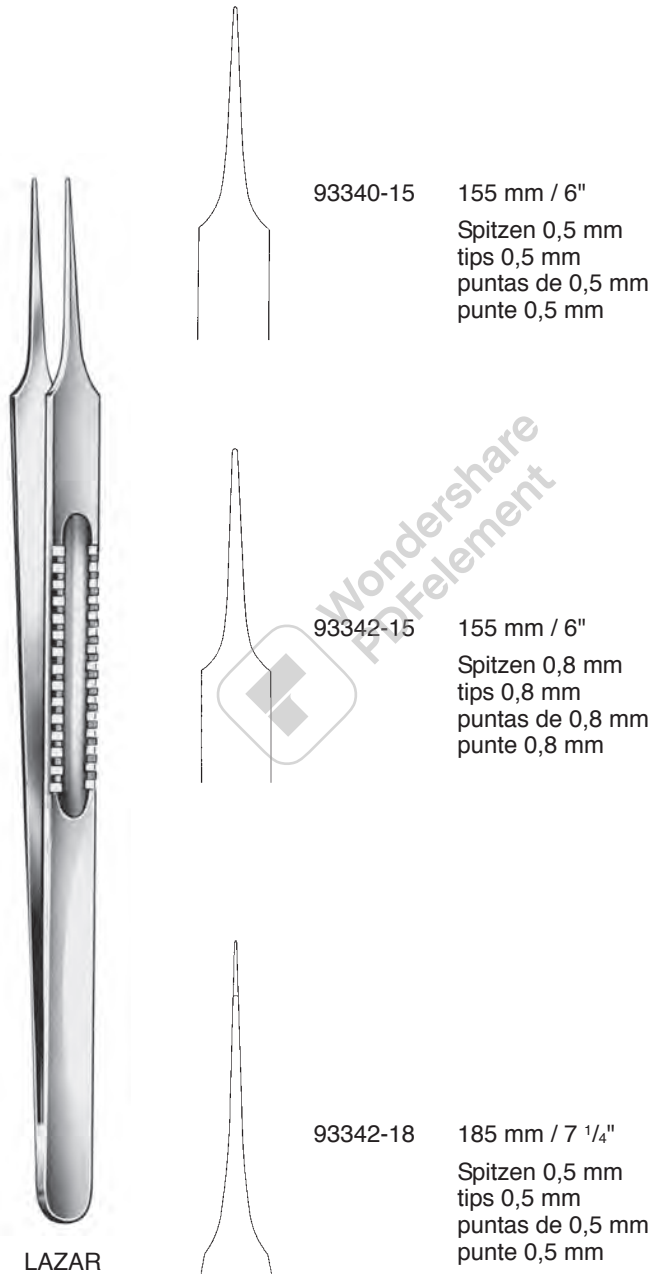

**HADEO**  
INSTRUMENTE GERMANY

Mikro Knüpfpinzetten  
Micro Suture Tying Forceps  
Micro Pinzas para ligaduras  
Micro Pinze per legature



WISE

0,3 mm 93350-12  
120 mm / 4 3/4"

0,3 mm 93350-13  
135 mm / 5 1/4"

0,3 mm 93351-13  
135 mm / 5 1/4"

1x2



93360-09  
95 mm  
3 3/4"

0,2 mm 93360-09  
95 mm / 3 3/4"

0,8 mm 93370-14  
140 mm / 5 1/2"

93370-18  
180 mm / 7" AUSTIN





**HADEO**  
INSTRUMENTE GERMANY

Ultra-Light-Pinzetten  
Ultra-Light-Forceps  
Pinzas-Ultra-Ligeras  
Pinza-Ultra-Leggera

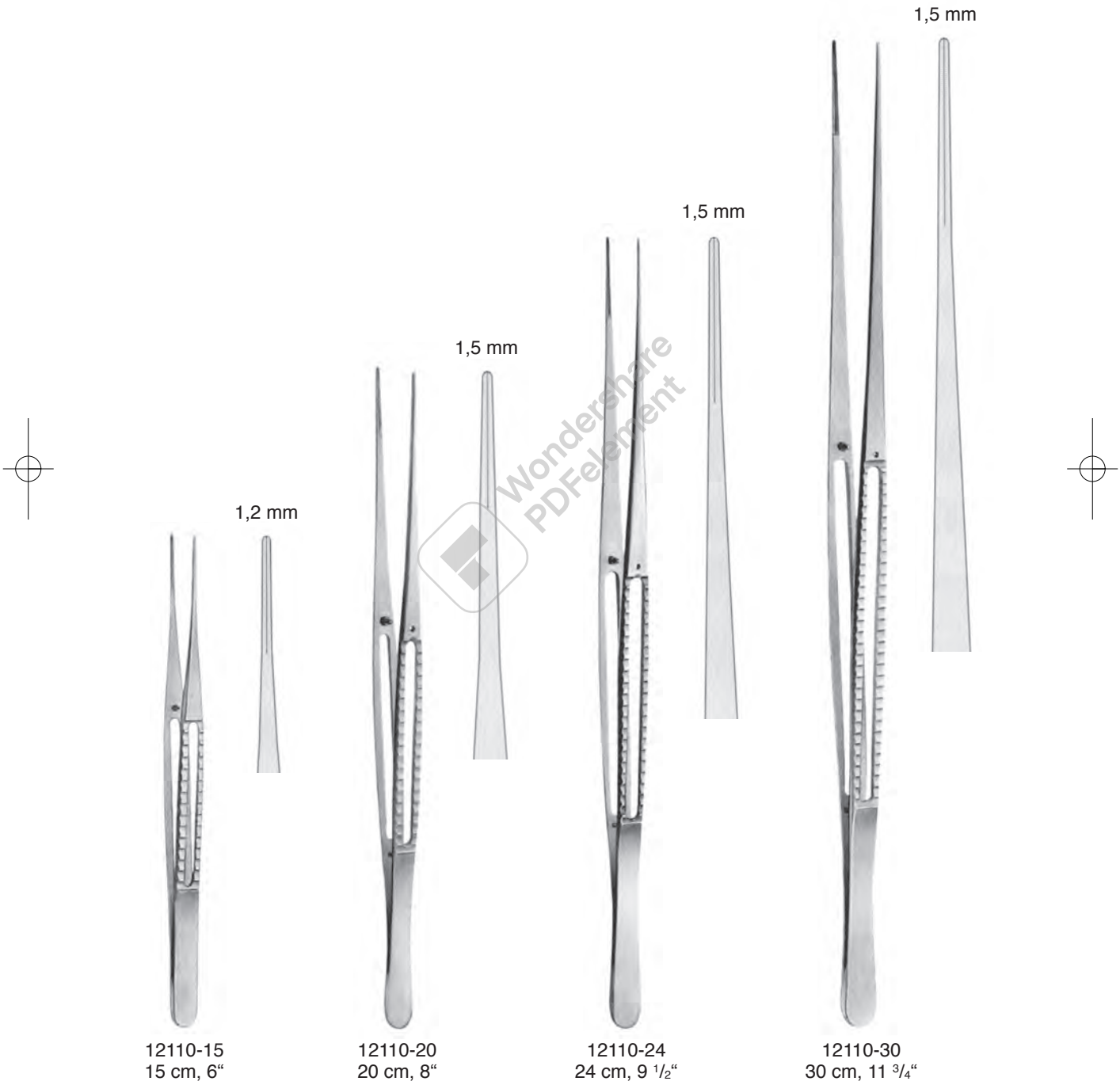

# HADEO

INSTRUMENTE GERMANY

Mikro Ring Pinzetten  
Micro Ring Forceps  
Micro Pinzas  
Micro Pinza



15 cm, 6"

Ø  
1 mm x 0,5 mm

Ø  
2 mm x 1 mm

12112-15D  
12112-15T

12114-15D  
12114-15T

18 cm, 7"

12112-18D  
12112-18T

12114-18D  
12114-18T

21 cm, 8 1/4"

12112-21D  
12112-21T

12114-21D  
12114-21T

23 cm, 9"

12112-23D  
12112-23T

12114-23D  
12114-23T

D = mit diamantiertem Maul  
with diamond jaw  
con boca de diamante  
con morso diamantato

T = Titan, titanium, titanio, titanio

**HADEO**  
INSTRUMENTE GERMANYAtrauma Mikro Pinzetten  
Atrauma Micro Forceps  
Micro Pinzas Atraumáticas  
Micro Pinza AtraumaticaWondershare  
PDFelement

	1,2 mm	2,0 mm
15 cm, 6"	12115-15 <b>12115-15T</b>	12116-15
18 cm, 7"	12115-18 <b>12115-18T</b>	12116-18
21 cm, 8 1/4"	12115-21 <b>12115-21T</b>	12116-21
23 cm, 9"	12115-23 <b>12115-23T</b>	12116-23

T = Titan, titanium, titanio, titanio

DE BAKEY

**HADEO**  
INSTRUMENTE GERMANY

TC Atrauma Pinzetten  
TC Atrauma Forceps  
Pinzas Atraumáticas con TC  
Pinza Atraumatica TC

Wondershare  
PDFelement

	1,2 mm	2,0 mm
18 cm, 7"	12117-18 TC	12118-18 TC
21 cm, 8 1/4"	12117-21 TC	12118-21 TC
23 cm, 9"	12117-23 TC	12118-23 TC

DE BAKEY TC

**HADEO**  
INSTRUMENTE GERMANY

Atraumatische Pinzetten  
Atraumatic Tissue Forceps  
Pinzas Atraumáticas  
Pinze Atraumatiche



DE BAKEY  
12302-16 16 cm, 6 1/4"  
12302-20 20 cm, 8"  
12302-24 24 cm, 9 1/2"



DE BAKEY  
12306-16 16 cm, 6 1/4"  
12306-20 20 cm, 8"  
12306-24 24 cm, 9 1/2"  
12306-30 30 cm, 11 3/4"



DE BAKEY  
12308-16 16 cm, 6 1/4"  
12308-20 20 cm, 8"  
12308-24 24 cm, 9 1/2"  
12308-30 30 cm, 11 3/4"



DE BAKEY  
12309-16 16 cm, 6 1/4"  
12309-20 20 cm, 8"  
12309-24 24 cm, 9 1/2"  
12309-30 30 cm, 11 3/4"



DE BAKEY  
12304-16 16 cm, 6 1/4"  
12304-20 20 cm, 8"  
12304-24 24 cm, 9 1/2"  
12304-30 30 cm, 11 3/4"



DE BAKEY  
12310-16 16 cm, 6 1/4"  
12310-20 20 cm, 8"  
12310-24 24 cm, 9 1/2"  
12310-30 30 cm, 11 3/4"

**HADEO**  
INSTRUMENTE GERMANY

Pinzetten zum Fassen von Gewebe, Tumoren  
Forceps for grasping tissue, tumors  
Pinzas para coger tejidos y tumores  
Pinze per afferrare tessuti e tumori

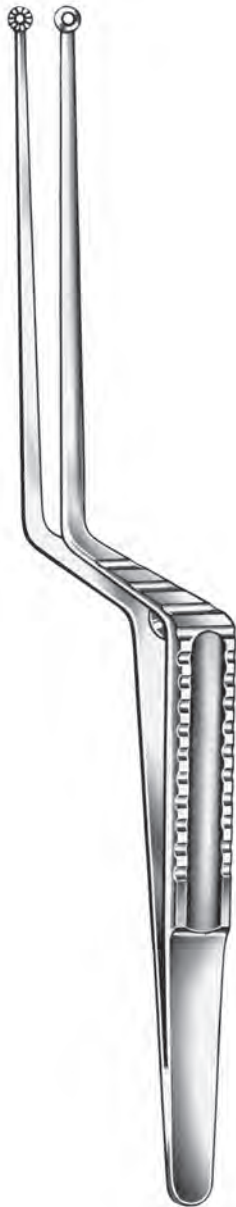

12295-22 200 mm / 8" YASARGIL  
Maul flach, gezahnt  
flat jaw, serrated  
boca plana, dentada  
morso piatto, striato



12297-22 200 mm / 8" HUNT  
Maul flach, gezahnt  
flat jaw, serrated  
boca plana, dentada  
morso piatto, striato

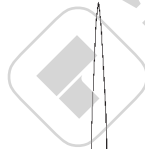

12300-18 185 mm / 7 1/4"  
feine Spitzen  
fine tips  
puntas finas  
punte acute



12302-18 185 mm / 7 1/4"  
breite Spitzen  
broad tips  
puntas anchas  
punte smusse



12303-18 185 mm / 7 1/4"  
breite Spitzen  
broad tips  
puntas anchas  
punte smusse

**HADEO**  
INSTRUMENTE GERMANY

Pinzetten zum Fassen von Gewebe, Tumoren  
Forceps for grasping tissue, tumors  
Pinzas para coger tejidos y tumores  
Pinze per afferrare tessuti e tumori

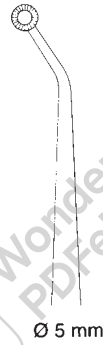

Maul flach, gezahnt  
flat jaw, serrated  
boca plana, dentada  
morso piatto, striato

Ø 5 mm

HUNT  
12305-20  
200 mm  
8"

**HADEO**  
 INSTRUMENTE GERMANY

Pinzetten zum Fassen von Gewebe, Tumoren  
 Forceps for grasping tissue, tumors  
 Pinzas para coger tejidos y tumores  
 Pinze per afferrare tessuti e tumori



⊙	93300-22	220 mm / 8 3/4"	YASARGIL
∅ 3 mm	93300-24	240 mm / 9 1/2"	YASARGIL-SAMII
		Maul löffelförmig	jaw spoon-shaped
		boca en forma de cucharilla	morso forma cucchiaio liscio
⊙	93302-22	220 mm / 8 3/4"	YASARGIL
∅ 5 mm	93302-24	240 mm / 9 1/2"	YASARGIL-SAMII
		Maul löffelförmig	jaw spoon-shaped
		boca en forma de cucharilla	morso forma cucchiaio liscio
⊙	93304-24	240 mm / 9 1/2"	YASARGIL-SAMII
∅ 7 mm		Maul löffelförmig	jaw spoon-shaped
		boca en forma de cucharilla	morso forma cucchiaio liscio
⊙	93306-22	220 mm / 8 3/4"	YASARGIL
∅ 3 mm		Maul flach, gezahnt	flat jaw, serrated
		boca plana, dentada	morso piatto, striato
⊙	93308-22	220 mm / 8 3/4"	YASARGIL
∅ 5 mm		Maul flach, gezahnt	flat jaw, serrated
		boca plana, dentada	morso piatto, striato
⊙	93310-22	220 mm / 8 3/4"	HEIFETZ
∅ 3 mm		Maul kürettenförmig	curette jaw, toothed
		boca en forma de cureta, estriada	morso forma curetta, striato
⊙	93312-22	220 mm / 8 3/4"	HEIFETZ
∅ 5 mm		Maul kürettenförmig	curette jaw, toothed
		boca en forma de cureta, estriada	morso forma curetta, striato



**HADEO**  
INSTRUMENTE GERMANY

Pinzetten zum Fassen von Gewebe, Tumoren  
Forceps for grasping tissue, tumors  
Pinzas para coger tejidos y tumores  
Pinze per afferrare tessuti e tumori

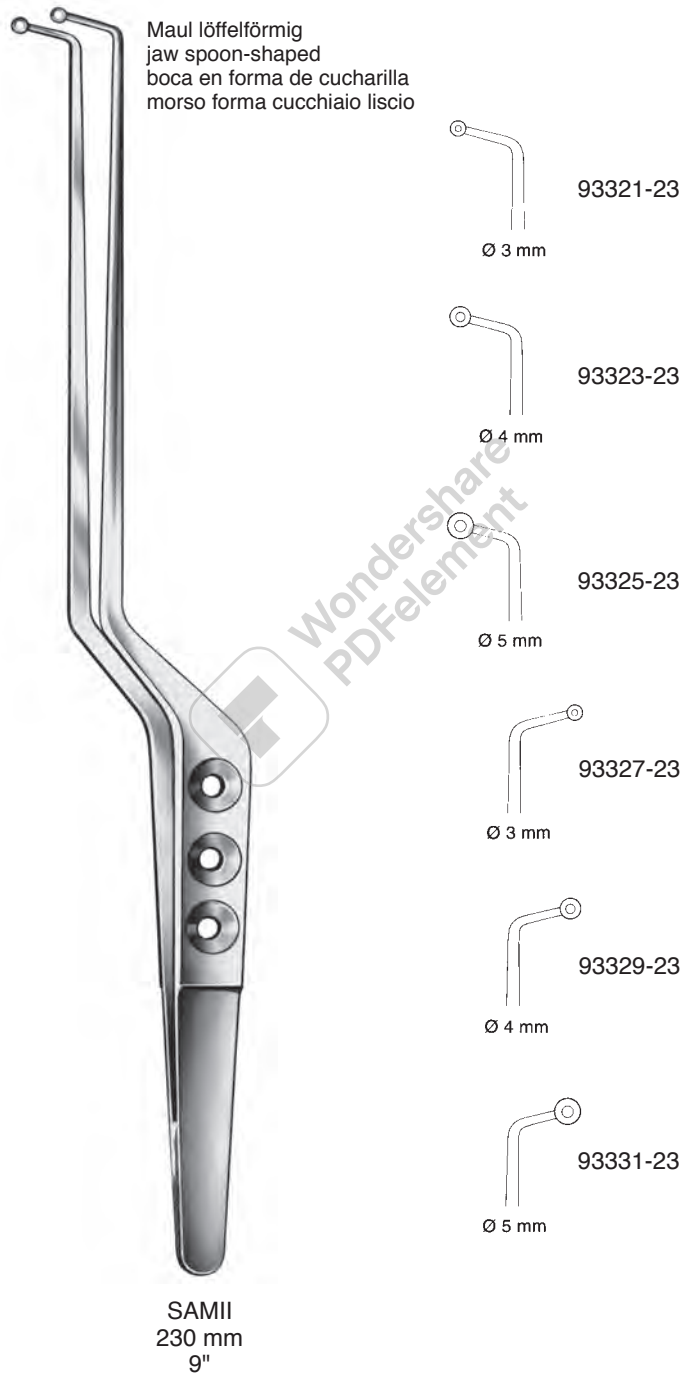

**HADEO**  
INSTRUMENTE GERMANY

Pinzetten, bajonettförmig  
Forceps, bayonet-shaped  
Pinzas, forma bayoneta  
Pinze, forma di baionetta



LUCAE  
45206-14 14 cm, 5 1/2"



LUCAE  
45206-16 16 cm, 6 1/4"



COTTLE  
45208-14 14 cm, 5 1/2"



JANSEN-GRUENWALD  
47154-20 20 cm, 8"



JANSEN  
47155-20 20 cm, 8"

**HADEO**  
 INSTRUMENTE GERMANY

Mikro Pinzetten, bajonettförmig  
 Micro Forceps, bayonet-shaped  
 Micro Pinzas, forma bayoneta  
 Micro Pinze, forma di baionetta



YASARGIL

93290-16	160 mm / 6 <sup>1</sup> / <sub>4</sub> "
93290-18	180 mm / 7"
93290-20	200 mm / 8"
93290-22	220 mm / 8 <sup>3</sup> / <sub>4</sub> "
93290-24	240 mm / 9 <sup>1</sup> / <sub>2</sub> "

Spitzen 0,6 mm  
 tips 0,6 mm  
 puntas de 0,6 mm  
 punte 0,6 mm

93292-16	160 mm / 6 <sup>1</sup> / <sub>4</sub> "
93292-18	180 mm / 7"
93292-20	200 mm / 8"
93292-22	220 mm / 8 <sup>3</sup> / <sub>4</sub> "
93292-24	240 mm / 9 <sup>1</sup> / <sub>2</sub> "

Spitzen 0,9 mm  
 tips 0,9 mm  
 puntas de 0,9 mm  
 punte 0,9 mm

93294-18	180 mm / 7"
----------	-------------

1 x 2 Zähne  
 1 x 2 teeth  
 1 x 2 dientes  
 1 x 2 denti



Wondershare PDFelement

KLEMMEN

CLAMPS

PINZAS

PINZE



[www.hadeo.co](http://www.hadeo.co)



Mini-Bulldogklemmen  
Mini Bulldog Clamps  
Clamps Bulldog Mini  
Pinze Bulldog Mini

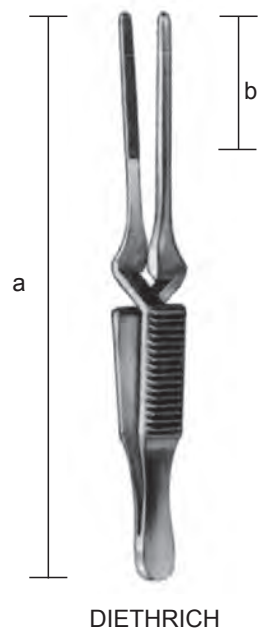

DIETHRICH

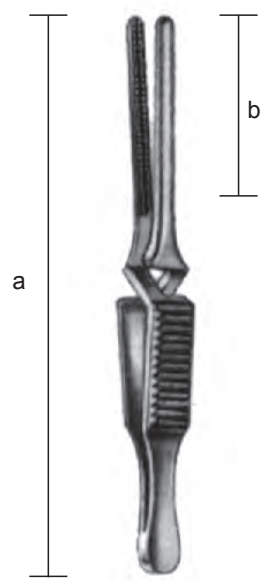
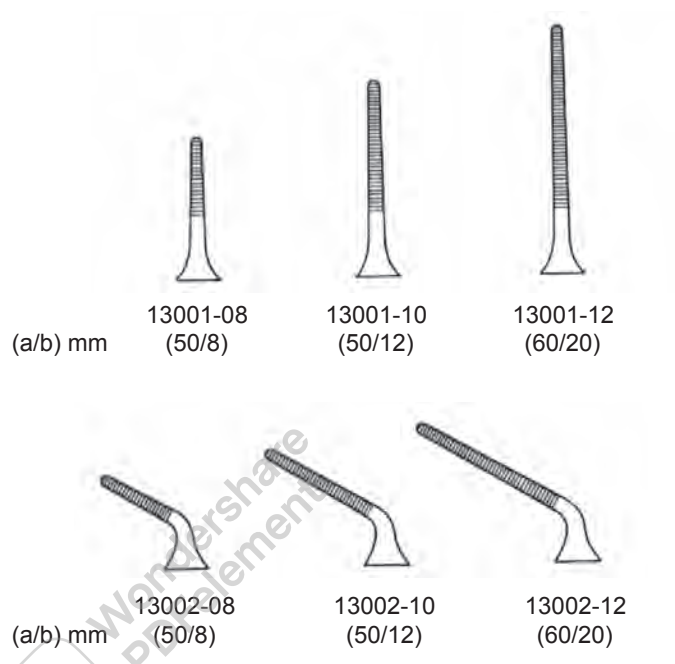

DE BAKEY-DIETHRICH

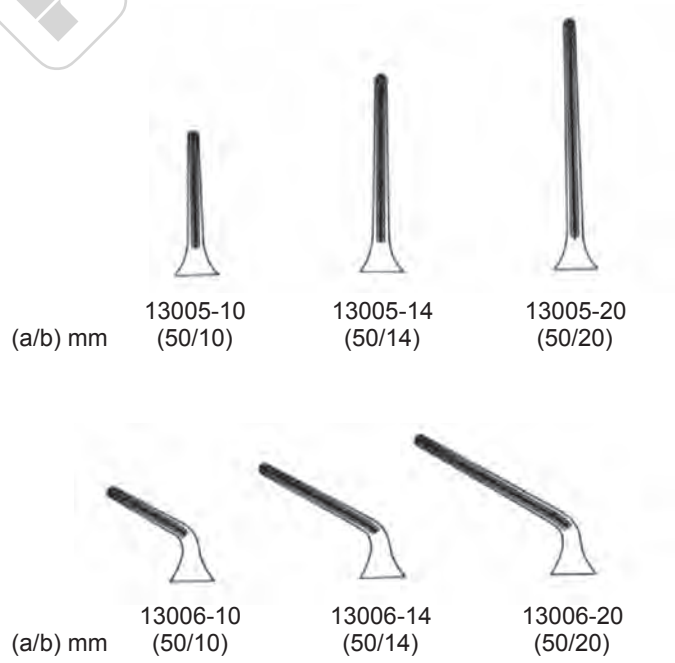



Titan-Atrauma-Bulldogklemmen  
 Titanium Atrauma Bulldog Clamps  
 Titan Clamp Bulldog  
 Titan Pinze Bulldog

	3 cm, 1.2"	3,5 cm, 1.4"	4 cm, 1 1/2"	5 cm, 2"
Vene	13010-30	13010-35	13010-40	13010-50
Arterie	13011-30	13011-35	13011-40	13011-50
	3 cm, 1.2"	3,5 cm, 1.4"	4 cm, 1 1/2"	5 cm, 2"
Vena	13012-30	13012-35	13012-40	13012-50
Arteria	13013-30	13013-35	13013-40	13013-50
	3 cm, 1.2"	3,5 cm, 1.4"	4 cm, 1 1/2"	5 cm, 2"
Vene	13014-30	13014-35	13014-40	13014-50
Arterie	13015-30	13015-35	13015-40	13015-50

**HADEO**  
INSTRUMENTE GERMANY

Atrauma-Bulldogklemmen  
Atrauma-Bulldog Clamps  
Clamps Atrauma Bulldog  
Pinze Atrauma Bulldog



13090-40  
40 mm / 1 1/2"  
  
13090-45  
45 mm / 1 3/4"  
  
13090-50  
50 mm / 2"



13091-40  
40 mm / 1 1/2"  
  
13091-45  
45 mm / 1 3/4"  
  
13091-50  
50 mm / 2"

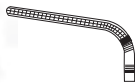

GLOVER  
13098-06  
57 mm  
2 3/8"



DE BAKEY  
13099-07  
73 mm  
2 3/4"



**HADEO**  
INSTRUMENTE GERMANY

Atrauma-Bulldogklemmen  
Atrauma Bulldog Clamps  
Clamps Atrauma Bulldog  
Pinze Atrauma Bulldog



DE BAKEY



13092-07	13092-08	13092-10	13092-12	13093-07	13093-08	13093-10	13093-12
7,5 cm	8,5 cm	10,5 cm	12 cm	7 cm	8 cm	10 cm	11,5 cm
3"	3.4"	4"	4 3/4"	2 3/4"	8 1/8"	4"	4 1/2"



GLOVER



13096-06	13096-07	13096-09	13096-11	13097-06	13097-07	13097-09	13097-11
6 cm	7 cm	9 cm	11 cm	5,5 cm	6,5 cm	8,5 cm	10,5 cm
2 1/4"	2 3/4"	3 1/2"	4 3/8"	2"	2 1/2"	3 1/4"	4"

**HADEO**  
INSTRUMENTE GERMANY

Atrauma-Bulldogklemmen  
Atrauma-Bulldog Clamps  
Clamps Atrauma Bulldog  
Pinze Atrauma Bulldog



DE BAKEY  
13094-09  
9 cm, 3 1/2"

DE BAKEY  
13095-10  
10 cm, 4"



3 cm, 1.2"

Maullänge  
Jaw length  
Largo de la boca  
Lunghezza del morso

DE BAKEY-HESS  
13113-03



Gefäßklemmen, Bulldogklemmen, Arterienklemmen  
 Bulldog Clamps, Hemostatic Forceps  
 Pinzas serra-finas, Pinzas hemostáticas  
 Pinze serrafina, Pinze emostatiche



**DIEFFENBACH**  
 13102-04 3,5 cm, 1.4"  
 13102-05 5,5 cm, 2.2"



**DIEFFENBACH**  
 13103-04 3,5 cm, 1.4"  
 13103-05 5,5 cm, 2.2"

gerade  
 straight  
 recta  
 rette



gebogen  
 curved  
 curva  
 curve

**JOHNS-HOPKINS**

13110-50	5,0 cm, 2"	13111-50
13110-55	5,5 cm, 2.2"	13111-55
13110-65	6,5 cm, 2.6"	13111-65
13110-70	7,0 cm, 2 3/4"	13111-70
13110-75	7,5 cm, 3"	13111-75
13110-90	9,0 cm, 3 1/2"	13111-90

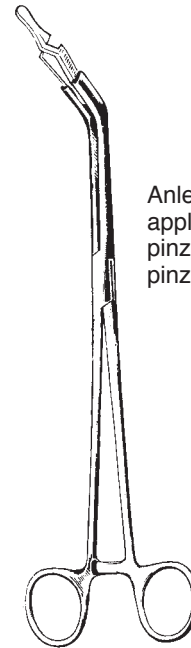

Anlegezange  
 applying Forceps  
 pinza aplicadora  
 pinza applicatrice

13115-00  
 23 cm, 9"

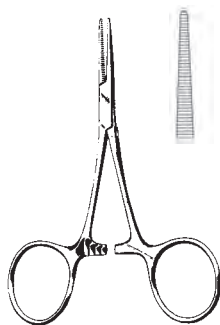

**HARTMANN**  
 13210-10  
 10 cm, 4"

**Micro-HARTMANN**  
 13214-10  
 10 cm, 4"

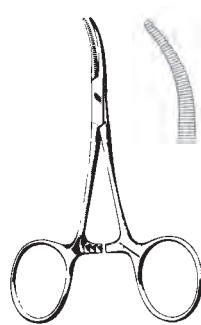

**HARTMANN**  
 13211-10  
 10 cm, 4"

**Micro-HARTMANN**  
 13215-10  
 10 cm, 4"

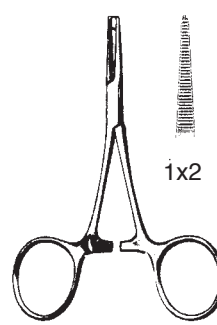

**HARTMANN**  
 13212-10  
 10 cm, 4"

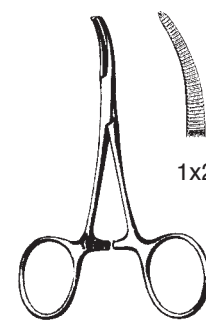

**HARTMANN**  
 13213-10  
 10 cm, 4"

**HADEO**  
INSTRUMENTE GERMANY

Arterienklemmen  
Hemostatic Forceps  
Pinzas hemostáticas  
Pinze emostatiche

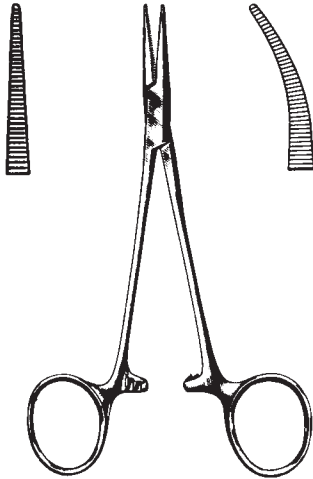

HALSTED-MOSQUITO

TITAN

**13224-12**

13220-12 12,5 cm, 5"

13220-14 14,0 cm, 5 1/2"

13220-18 18,0 cm, 7"

TITAN

**13225-12**

13221-12

13221-14

13221-18

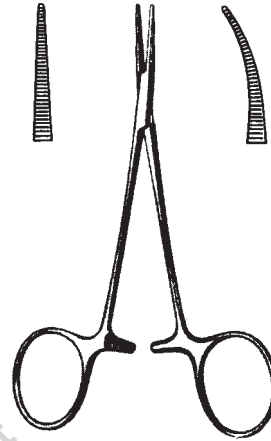

HALSTED-MOSQUITO micro

13222-12 12,5 cm, 5" 13223-12

JACOBSON micro

13226-12 12,0 cm, 4 3/4" 13227-12

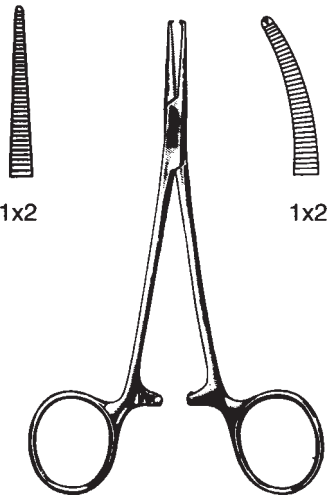

1x2

1x2

HALSTED-MOSQUITO

13230-12 12,5 cm, 5" 13231-12

13230-14 14,0 cm, 5 1/2" 13231-14

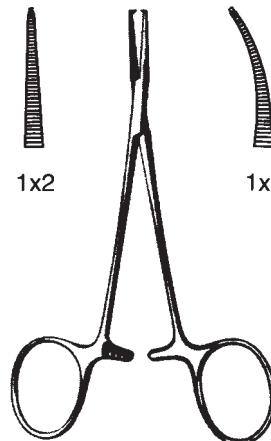

1x2

1x2

HALSTED-MOSQUITO micro

13232-12 12,5 cm, 5" 13233-12

**HADEO**  
INSTRUMENTE GERMANY

Arterienklemmen  
Hemostatic Forceps  
Pinzas hemostáticas  
Pinze emostatiche

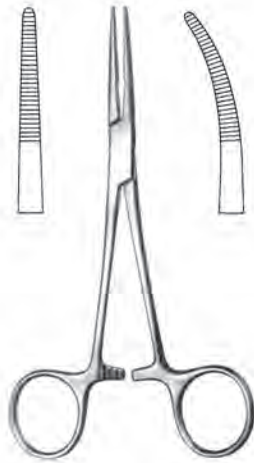

**KELLY**  
13240-14 14 cm, 5 1/2" 13241-14  
13240-18 18 cm, 7" 13241-18  
**13244-14** 14 cm, 5 1/2" **13245-14**  
TITAN TITAN

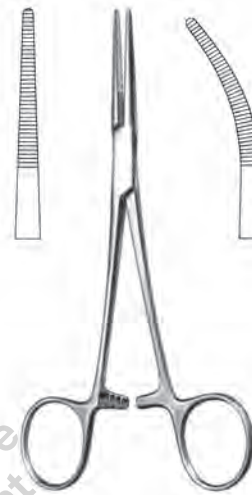

**KELLY-RANKIN**  
13242-16 16 cm, 6 1/4" 13243-16

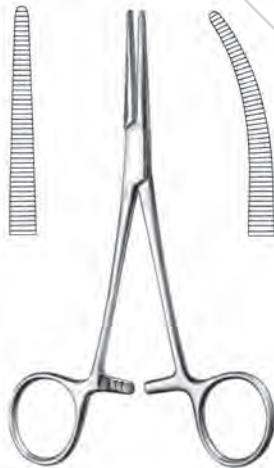

**CRILE**  
13250-14 14 cm, 5 1/2" 13251-14  
13250-18 18 cm, 7" 13251-18  
**13254-14** 14 cm, 5 1/2" **13255-14**  
TITAN TITAN

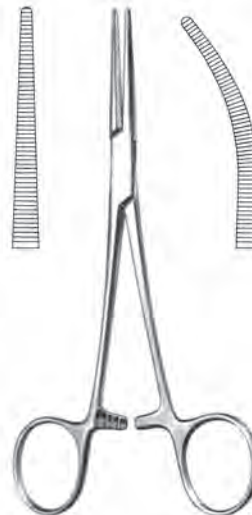

**CRILE-RANKIN**  
13262-16 16 cm, 6 1/4" 13263-16

**HADEO**  
INSTRUMENTE GERMANY

Arterienklemmen  
Hemostatic Forceps  
Pinzas hemostáticas  
Pinze emostatiche

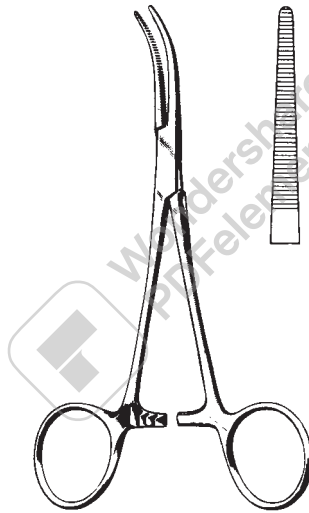

DANDY  
13345-12 12 cm, 4  $\frac{3}{4}$ "  
13345-14 14 cm, 5  $\frac{1}{2}$ "

**HADEO**  
INSTRUMENTE GERMANY

Kopfschwartzangen  
Scalp Flap Forceps  
Pinzas para el cuero cabelludo  
Pinze per cuoio capelluto

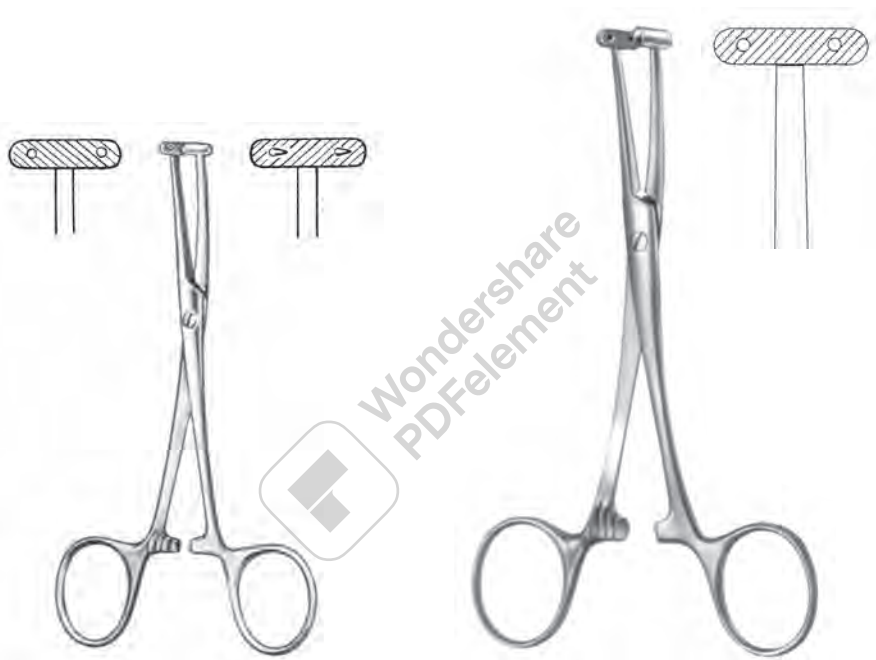

**MARTEL**  
13364-14 14 cm, 5 1/2"

**WILLET MARTEL**  
13366-19 19 cm, 7 1/2"

**HADEO**  
INSTRUMENTE GERMANY

Präparier- und Ligaturklemmen  
Dissecting and Ligature Forceps  
Pinzas para preparaciones y para ligaduras  
Pinze per preparazione e per legatura



**FUCHSIG**  
13414-20 19 cm, 7 1/2"



**ADSON BABY**  
13415-14 14,0 cm, 5 1/2"  
13415-18 18,5 cm, 7 1/4"



**HADEO**  
INSTRUMENTE GERMANY

Präparier- und Ligaturklemmen  
Dissecting and Ligature Forceps  
Pinzas para preparaciones y para ligaduras  
Pinze per preparazione e per legatura



GEMINI

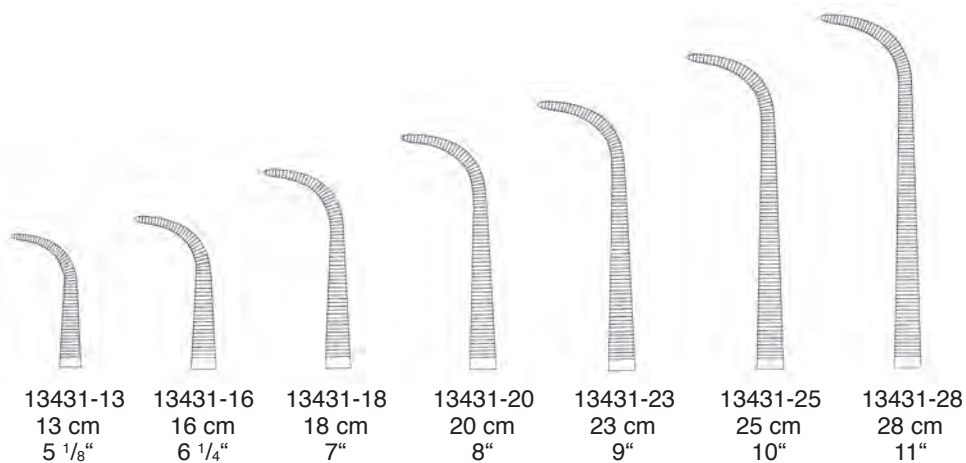

**HADEO**  
INSTRUMENTE GERMANY

Präparier- und Ligaturklemmen  
Dissecting and Ligature Forceps  
Pinzas para preparaciones y para ligaduras  
Pinze per preparazione e per legatura



MIXTER BABY  
13475-14  
14 cm, 5 1/2"



MIXTER BABY  
13475-18  
18 cm, 7"

**HADEO**  
INSTRUMENTE GERMANY

Tumorfäßzange  
Tumor Grasping Forcep  
Pinza para agarrar tumores  
Pinze per afferrare tumori



TOENNIS  
20 cm, 8"



13610-01



13610-02



13610-03

**HADEO**  
INSTRUMENTE GERMANY

Sehnenfaßzange  
Tendon grasping Forceps  
Pinza para agarrar tendones  
Pinze da presa per tendini



CAROLL  
33966-11  
11 cm, 4 <sup>3</sup>/<sub>8</sub>"

Wondershare PDFelement

NADELHALTER

NEEDLE HOLDERS

PORTA-AGUJAS

PORT'AGHI



[www.hadeo.co](http://www.hadeo.co)

**HADEO**  
INSTRUMENTE GERMANY

Nadelhalter  
Needle Holders  
Porta-agujas  
Port'aghi

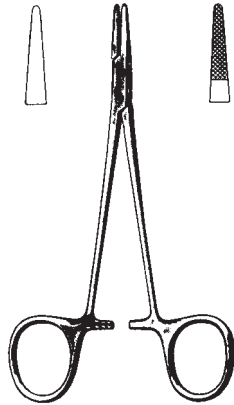

**HALSEY**  
25130-13 25140-13  
25134-13 TC 25144-13 TC  
13 cm, 5 1/8"

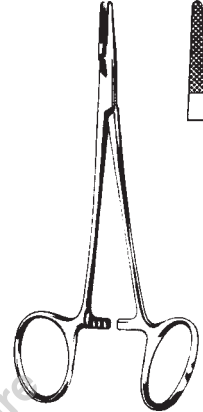

**NEIVERT**  
25148-13 TC  
13 cm, 5 1/8"

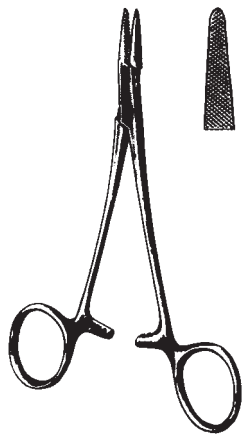

**BAUMGARTNER**  
25150-14 25154-14 TC  
14,0 cm, 5 1/2"



**CRILE-WOOD**  
25160-15 15 cm, 6" 25164-15 TC  
25160-18 18 cm, 7" 25164-18 TC  
25160-20 20 cm, 8" 25164-20 TC  
25160-23 23 cm, 9" 25164-23 TC

**HADEO**  
INSTRUMENTE GERMANY

Nadelhalter  
Needle Holders  
Porta-agujas  
Port'aghi

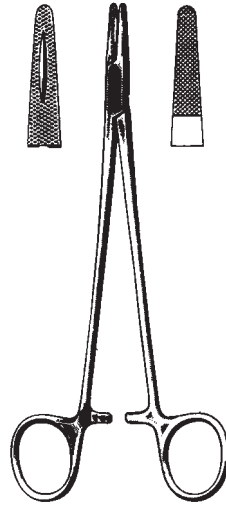

MAYO-HEGAR

25180-14	14 cm, 5 1/2"	25184-14 TC
25180-16	16 cm, 6 1/4"	25184-16 TC
25180-18	18 cm, 7"	25184-18 TC
25180-20	20 cm, 8"	25184-20 TC
25180-24	24 cm, 9 1/2"	25184-24 TC
25180-26	26 cm, 10 1/4"	25184-26 TC



DE BAKEY

25214-16 TC	16 cm, 6 1/4"
25214-18 TC	18 cm, 7"
25214-20 TC	20 cm, 8"
25214-23 TC	23 cm, 9"
25214-26 TC	26 cm, 10 1/4"



RYDER 1 mm

25224-13 TC	13 cm, 5 1/8"
25224-15 TC	15 cm, 6"
25224-18 TC	18 cm, 7"
25224-20 TC	20 cm, 8"
25224-23 TC	23 cm, 9"
25224-26 TC	26 cm, 10 1/4"

RYDER 2 mm

25225-13 TC
25225-15 TC
25225-18 TC
25225-20 TC
25225-23 TC
25225-26 TC

**HADEO**  
INSTRUMENTE GERMANY

Mikro-Nadelhalter  
Micro Needle Holders  
Micro-porta-agujas  
Micro portaghi

ohne Sperre  
without lock  
sin cremallera  
senza cremagliera

mit Sperre  
with lock  
con cremallera  
con cremagliera



11,5 cm, 4 1/2"  
13,0 cm, 5 1/8"  
14,0 cm, 5 1/2"  
18,0 cm, 7"  
21,0 cm, 8 1/4"  
23,0 cm, 9"



25660-12	25661-12
25660-13	25661-13
25660-14	25661-14
25700-18	25701-18

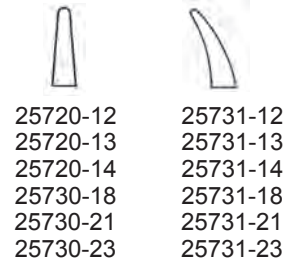

25720-12	25731-12
25720-13	25731-13
25720-14	25731-14
25730-18	25731-18
25730-21	25731-21
25730-23	25731-23

mit diamantiertem Maul  
with diamond jaw  
con boca de diamante  
con morso diamantato

11,5 cm, 4 1/2"  
13,0 cm, 5 1/8"  
14,0 cm, 5 1/2"  
18,0 cm, 7"  
21,0 cm, 8 1/4"  
23,0 cm, 9"

25720-12D	25671-12D
25720-13D	25671-13D
25720-14D	25671-14D
25730-18D	25731-18D
25730-21D	25731-21D
25730-23D	25731-23D

T = Titan, titanium, titanio, titanio



15,0 cm, 6"  
18,0 cm, 7"  
21,0 cm, 8 1/4"

93250-15T	93251-15T	93260-15T	93261-15T
93250-18T	93251-18T	93260-18T	93261-18T
93250-21T	93251-21T	93260-21T	93261-21T

BARRAQUER





Mikro-Nadelhalter mit Sperre  
 Micro Needle Holders, with lock  
 Micro-porta-agujas con cremallera  
 Micro portaghi, con cremagliera

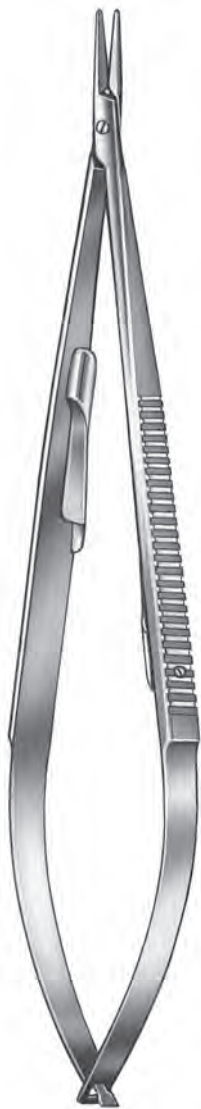

CASTROVIEJO



14,0 cm, 5 1/2"  
 18,0 cm, 7"  
 21,5 cm, 8 1/2"  
 23,0 cm, 9"

25670-14  
 25670-18  
 25670-21

25671-14  
 25671-18

25672-14  
 25672-18  
 25672-21  
 25672-23

25673-14  
 25673-18

mit TC 1,4 mm  
 with TC jaw 1,4 mm  
 con TC 1,4 mm  
 con morso in TC 1,4 mm

14,0 cm, 5 1/2"  
 18,0 cm, 7"  
 21,5 cm, 8 1/2"  
 23,0 cm, 9"

25674-14  
 25674-18  
 25674-21

25675-14  
 25675-18

25676-14  
 25668-18  
 25668-21  
 25668-23

25677-14  
 25691-18

mit diamantiertem Maul 0,8 mm  
 with diamond jaw 0,8 mm  
 con boca de diamante 0,8 mm  
 con morso diamantato 0,8 mm

14,0 cm, 5 1/2"  
 18,0 cm, 7"  
 21,5 cm, 8 1/2"  
 23,0 cm, 9"

25672-14D  
 25672-18D  
 25672-21D  
 25672-23D

25673-14D  
 25673-18D

T = Titan, titanium, titanio, titanio  
 Maul/jaw/boca/morso 0,4mm

14,0 cm, 5 1/2"  
 18,0 cm, 7"  
 21,5 cm, 8 1/2"

25672-14T  
 25672-18T  
 25672-21T

25673-14T  
 25673-18T  
 25673-21T

**HADEO**  
INSTRUMENTE GERMANY

Mikro-Nadelhalter, bajonettförmig  
Micro Needle Holders, bayonet-shaped  
Micro-porta-agujas, forma bayoneta  
Micro port'aghi, forma baionetta



93092-20	200 mm / 8"
93092-22	225 mm / 9"



93093-16	165 mm / 6 1/2"
93093-20	200 mm / 8"
93093-22	225 mm / 9"
93093-24	245 mm / 9 3/4"

YASARGIL

**HADEO**  
INSTRUMENTE GERMANY

Mikro-Nadelhalter  
Micro Needle Holders  
Micro-porta-agujas  
Micro port'aghi



93170-16 160 mm / 6 1/4"  
93170-18 185 mm / 7 1/4"

ohne Sperre  
without catch  
sin cremallera  
senza cremagliera



93171-16 160 mm / 6 1/4"  
93171-18 185 mm / 7 1/4"

ohne Sperre  
without catch  
sin cremallera  
senza cremagliera



**HADEO**  
INSTRUMENTE GERMANY

Mikro-Nadelhalter  
Micro Needle Holders  
Micro-porta-agujas  
Micro port'aghi



93200-16  
93200-18

160 mm / 6 1/4"  
185 mm / 7 1/4"

ohne Sperre  
without catch  
sin cremallera  
senza cremagliera



93201-16  
93201-18

160 mm / 6 1/4"  
185 mm / 7 1/4"

ohne Sperre  
without catch  
sin cremallera  
senza cremagliera

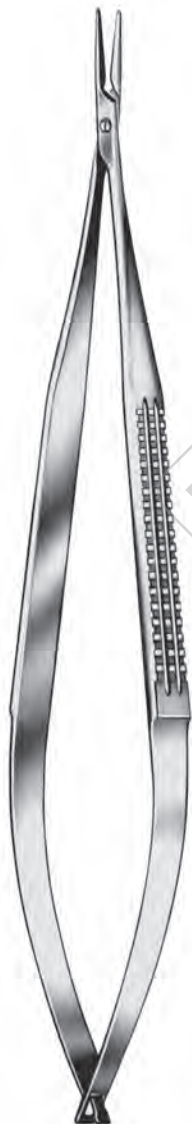



HAKEN

HOOKS

GANCHOS

UNCINI



[www.hadeo.co](http://www.hadeo.co)



Hauthäkchen  
 Skin Hooks  
 Ganchos para la piel  
 Uncini per pelle

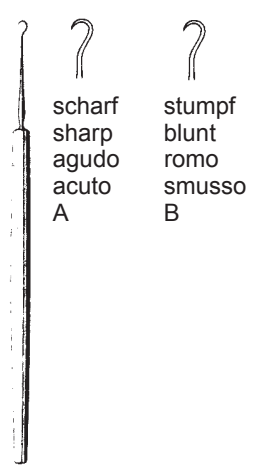

scharf  
 sharp  
 agudo  
 acuto  
 A

stumpf  
 blunt  
 romo  
 smusso  
 B

FRAZIER

- A 19214-13 13 cm, 5"
- A 19214-18 18 cm, 7"
- B 19215-13 13 cm, 5"
- B 19215-18 18 cm, 7"



JOSEPH  
 16 cm, 6 1/4"



19216-01



19216-02  
 2 mm



19216-05  
 5 mm



19216-07  
 7 mm



19216-10  
 10 mm



FREER  
 47558-15  
 15 cm, 6"



GILLIES  
 18 cm, 7"



Fig. 1  
 47560-18



Fig. 2  
 47562-18

**HADEO**  
INSTRUMENTE GERMANY

Wundhaken  
Retractors  
Separadores  
Divaricatori



Blattretractor  
blade retractor  
separador de hoja  
lama divaricatore

CLOWARD  
19128-18 18 mm  
19128-20 20 mm  
19128-23 23 mm



CUSHING  
19234-20  
20 cm, 8"

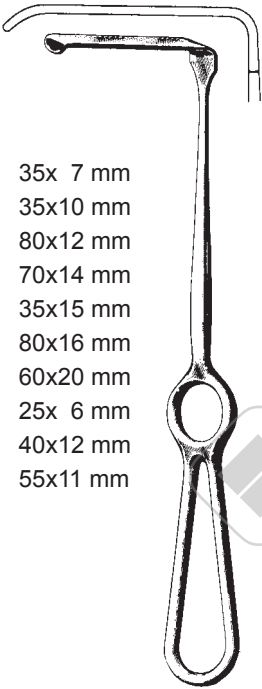

CUSHING  
19235-21  
21,5 cm, 8 1/2"

**HADEO**  
INSTRUMENTE GERMANYWundhaken  
Retractors  
Separadores  
Divaricatori

19314-07	35x 7 mm
19314-10	35x10 mm
19314-12	80x12 mm
19314-14	70x14 mm
19314-15	35x15 mm
19314-16	80x16 mm
19314-20	60x20 mm
19315-06	25x 6 mm
19330-40	40x12 mm
19330-55	55x11 mm

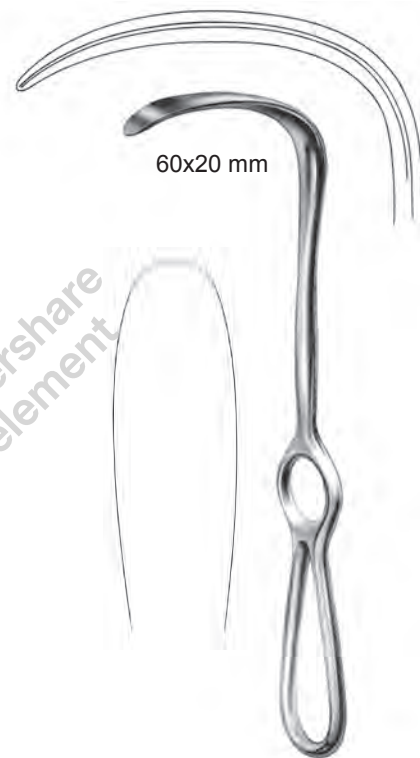
KOCHER-LANGENBECK  
21 cm, 8 1/4"LANGENBECK  
19315-21  
21 cm, 8 1/4"



**HADEO**  
INSTRUMENTE GERMANY

Wundhaken  
Retractors  
Separadores  
Divaricatori

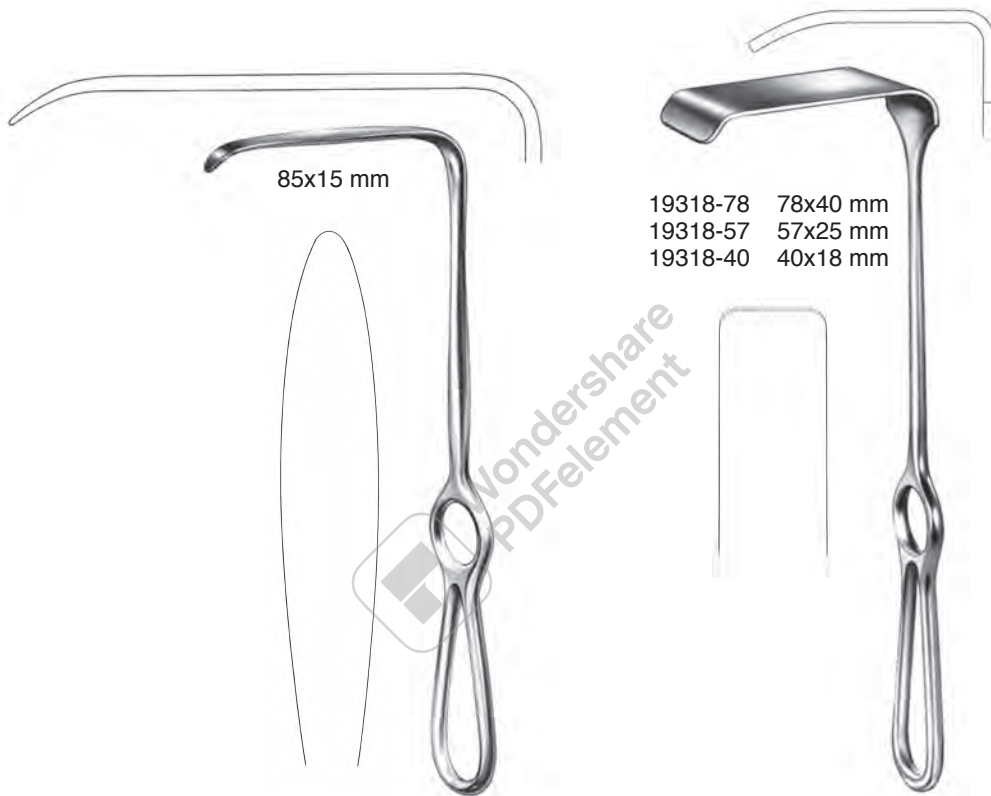

**LANGENBECK**  
19317-21  
21 cm, 8 1/4"

**KOCHER**  
23 cm, 9"

**HADEO**  
INSTRUMENTE GERMANY

Wundhaken  
Retractors  
Separadores  
Divaricatori

19694-01  
50 x 16 mm  
20 cm, 8"



19694-02  
75 x 25 mm  
23 cm, 9"



19694-03  
90 x 50 mm  
24 cm, 9 1/2"



MEYERDING

**HADEO**  
INSTRUMENTE GERMANY

Spinalhaken  
Spinal retractors  
Separadores espinales  
Divaricatori spinali



TAYLOR  
16,5 cm, 6 1/2"  
33831-16 75 x 30 mm  
33833-16 100 x 30 mm

**HADEO**  
INSTRUMENTE GERMANY

Nervhaken, Durahaken  
Nerve Hooks, Dura Hooks  
Ganchos para nervios y para dura-madre  
Unicini per nervi e per dura-madre



DANDY  
41051-20  
20 cm, 8"



DANDY  
41052-20  
20 cm, 8"



DANDY  
41053-20  
20 cm, 8"

**HADEO**  
INSTRUMENTE GERMANY

Nervhaken, Durahaken  
Nerve Hooks, Dura Hooks  
Ganchos para nervios y para dura-madre  
Unicini per nervi e per dura-madre



**CRILE**  
41054-20 20 cm, 8"  
41054-28 28 cm, 11"

Fig. 1



**CUSHING**  
41056-18 18 cm, 7"  
41056-28 28 cm, 11"

Fig. 2



**CUSHING**  
41058-18 18 cm, 7"  
41058-28 28 cm, 11"

**HADEO**  
INSTRUMENTE GERMANY

Nervhaken, Durahaken  
Nerve Hooks, Dura Hooks  
Ganchos para nervios y para dura-madre  
Unicini per nervi e per dura-madre



GRAHAM  
41061-16  
16,5 cm, 6 1/2"



SACHS  
41064-16  
18,5 cm, 7 1/4"



ADSON  
41068-20  
20 cm, 8"



ADSON  
41069-20  
20 cm, 8"



SMITHWICK  
41070-29  
29 cm, 11.4"

**HADEO**  
INSTRUMENTE GERMANY

Nervwurzelnhaken  
Nerve Root Retractors  
Separadores de raiz de nervios  
Uncini per le radici dei nervi

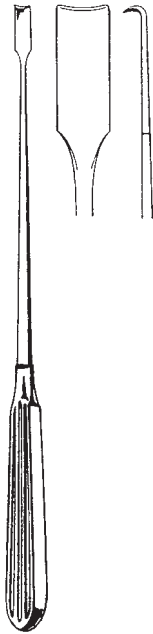

SCOVILLE  
41074-23  
23 cm, 9"



HOLSHER  
41075-24  
24 cm, 9 1/2"

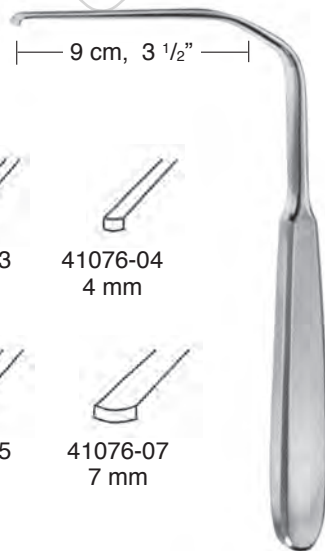

HESS  
17,5 cm, 7"

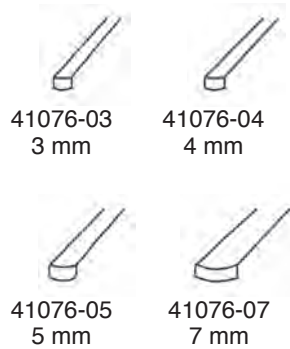

**HADEO**  
INSTRUMENTE GERMANY

Nervwurzelnhaken  
Nerve Root Retractors  
Separadores de raiz de nervios  
Uncini per le radici dei nervi

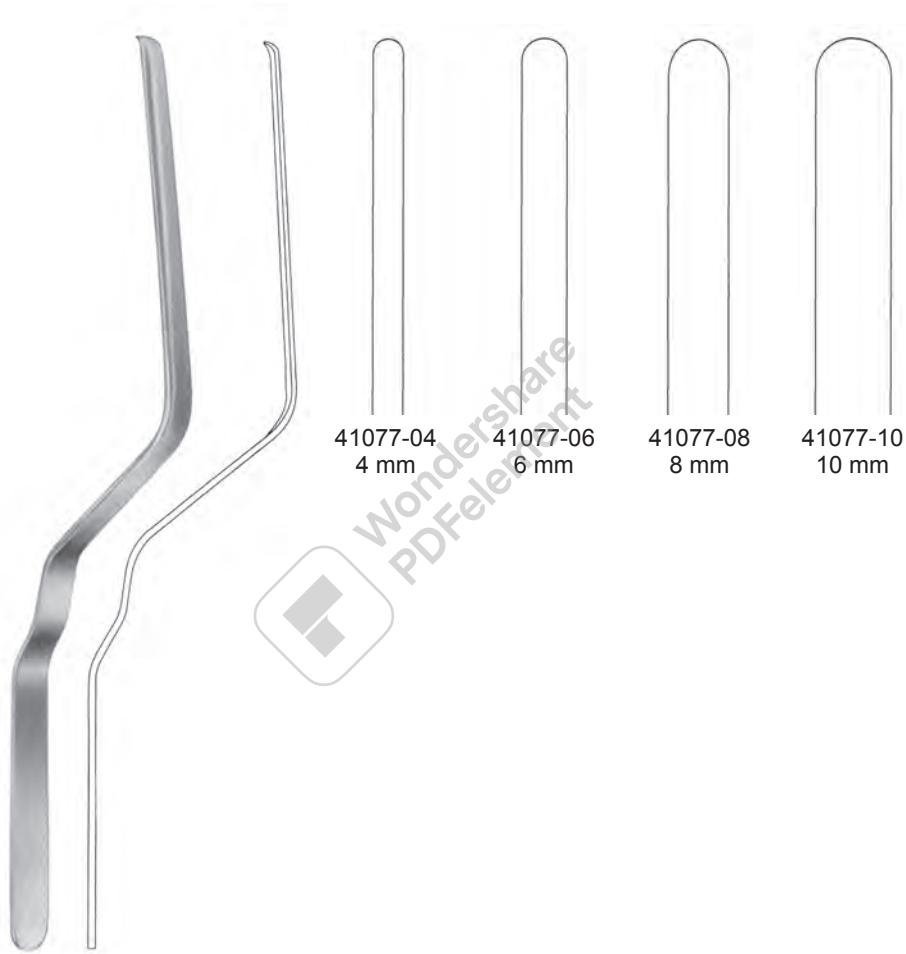

CASPAR  
24 cm, 9 1/2"



**HADEO**  
INSTRUMENTE GERMANY

Nervwurzelhaken  
Nerve Root Retractors  
Separadores de raiz de nervios  
Uncini per le radici dei nervi



D'ERRICO  
41078-23  
23 cm, 9"



LOVE  
41079-21  
21 cm, 8 1/4"

**HADEO**  
INSTRUMENTE GERMANY

Nervwurzelnhaken, Galea Haken  
Nerve Root Retractors, Galea Hooks  
Separadores de raiz de nervios, Gancho para galea  
Uncini per le radici dei nervi, Uncini galea

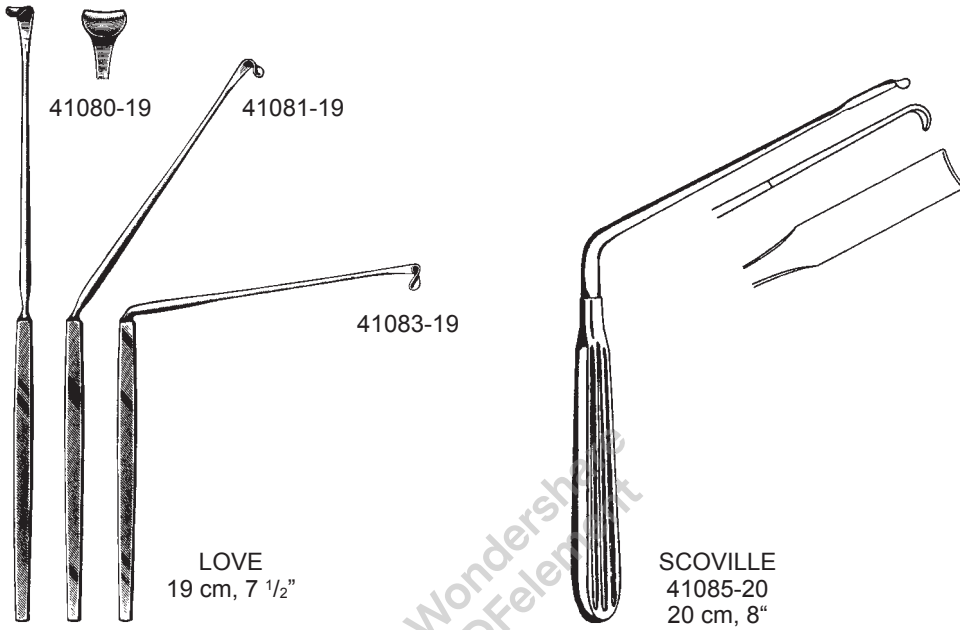

**HADEO**  
INSTRUMENTE GERMANY

Explorations- und Koagulationshäkchen  
Exploration- and Coagulation Hooks  
Ganchos para exploración y coagulación  
Uncini per esplorazione e coagulazione



CASPAR  
245 mm  
9 3/4"



93400-01 isoliert / insulated  
aislado / isolato

93400-02 nicht isoliert / not insulated  
no-aislado / non isolato



93401-01 isoliert / insulated  
aislado / isolato

93401-02 nicht isoliert / not insulated  
no-aislado / non isolato

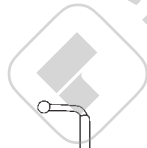

93402-01 isoliert / insulated  
aislado / isolato

93402-02 nicht isoliert / not insulated  
no-aislado / non isolato



93403-01 isoliert / insulated  
aislado / isolato

93403-02 nicht isoliert / not insulated  
no-aislado / non isolato

**HADEO**  
INSTRUMENTE GERMANY

Fadenführer, Nerv- und Gefäßhäkchen  
Ligature Guides, Nerve- and Vessel Hooks  
Guia para ligaduras, ganchos para nervios y vasos  
Conduitori per legature, uncini per nervi e vasi



**YASARGIL**  
185 mm / 7 1/4"

Fadenführer geknöpft  
Ligature Guides, probe pointed  
Guiador abotonado  
Conduittore bottonuto per legature



93405-01



93405-02



93405-03



93405-04



41242-19



41243-19



41244-19



41245-19

**KRAYENBÜHL**  
185 mm / 7 1/4"

Nerv- und Gefäßhäkchen  
Nerve- and Vessel Hooks  
Ganchos para nervios y vasos  
Uncini per nervi e vasi

**HADEO**  
INSTRUMENTE GERMANY

Griff für auswechselbare Gefäßmesser und Haken  
Handle for interchangeable Vessel Knives and Hooks  
Mangos para bisturí y ganchos intercambiables  
Manico per lame da bisturi e uncini intercambiabili



93440-02      95 mm / 3 3/4"      JACOBSON

auswechselbares Gefäßmesser für Griff 93440-01  
interchangeable vessel knife for handle 93440-01  
cuchillo suelto para mango 93440-01  
bisturi intercambiabile per manico 93440-01



93440-03      85 mm / 3 3/8"

auswechselbares Haken für Griff 93440-01  
interchangeable hook for handle 93440-01  
cuchillo suelto para mango 93440-01  
uncino intercambiabile per manico 93440-01







93440-01  
105 mm / 4 1/8"

Griff mit Spannfutter  
handle with chuck  
mango con chuck  
manico con mandrino

**HADEO**  
INSTRUMENTE GERMANY

Mikro-Häkchen, Mikro-Gefäßmesser  
Micro Hooks, Micro Vessel Knives  
Micro-ganchitos y micro-cuchillos  
Micro uncinetti e micro coltelli per vasi



	93450-01	230 mm / 9"	scharf sharp agudo acuto	
	93450-02	230 mm / 9"	stumpf blunt romo smusso	
90° 	41236-19	185 mm / 7 1/4"	FISCH scharf, gebogen sharp, curved agudo, curvado acuto, curva	
90° 	41237-19	185 mm / 7 1/4"	FISCH scharf, abgewinkelt sharp, angled agudo, angulado acuto, angolato	
	93450-04	185 mm / 7 1/4"	JACOBSON Mikro-Gefäßmesser Micro Vessel Knife Micro-cuchillo Micro coltello per vasi	

SPREIZER

SPREADER

SEPARADORES

DIVARICATORI



[www.hadeo.co](http://www.hadeo.co)

**HADEO**  
INSTRUMENTE GERMANY

Wundspreizer  
Self-retaining Retractors  
Separadores autoestáticos  
Divaricatori autostatici

scharf  
sharp  
agudo  
acuto

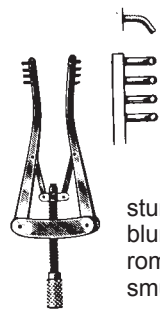

stumpf  
blunt  
romo  
smusso

	ALM	
19620-07	7 cm, 2 3/4"	19621-07
19620-10	10 cm, 4"	19621-10



JANSEN  
19630-10  
10 cm, 4"

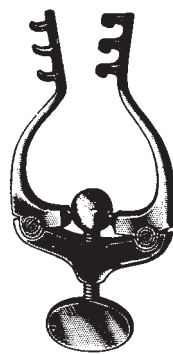

JANSEN  
19631-10  
10 cm, 4"

scharf  
sharp  
agudo  
acuto



stumpf  
blunt  
romo  
smusso

HOLZHEIMER  
19634-10 19635-10  
10 cm, 4"





Wundspreizer  
Self-retaining Retractors  
Separadores autoestáticos  
Divaricatori autostatici

2x3

scharf  
sharp  
agudo  
acuto

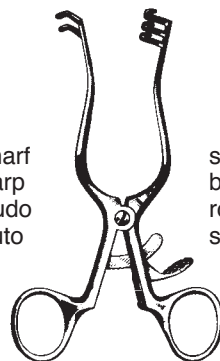

stumpf  
blunt  
romo  
smusso

WEITLANER  
19650-10 19651-10  
11,5 cm, 4 1/2"

3x3

scharf  
sharp  
agudo  
acuto

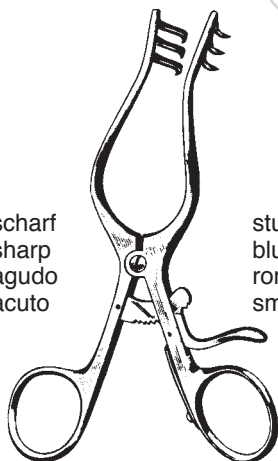

stumpf  
blunt  
romo  
smusso

WEITLANER-WULLSTEIN  
19654-13 19655-13  
13 cm, 5 1/8"

3x4

scharf  
sharp  
agudo  
acuto

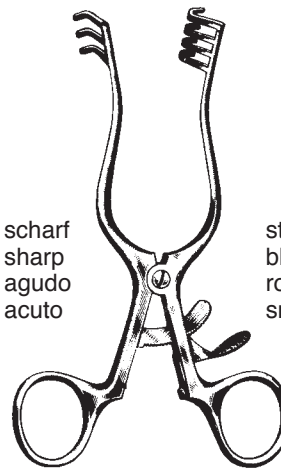

stumpf  
blunt  
romo  
smusso

WEITLANER  
19670-14 14,0 cm, 5 1/2" 19671-14  
19670-16 16,5 cm, 6 1/2" 19671-16  
19670-20 20,0 cm, 8" 19671-20  
19670-24 24,0 cm, 9 1/2" 19671-24

**HADEO**  
INSTRUMENTE GERMANY

Wundspreizer  
Self-retaining Retractors  
Separadores autoestáticos  
Divaricatori autostatici

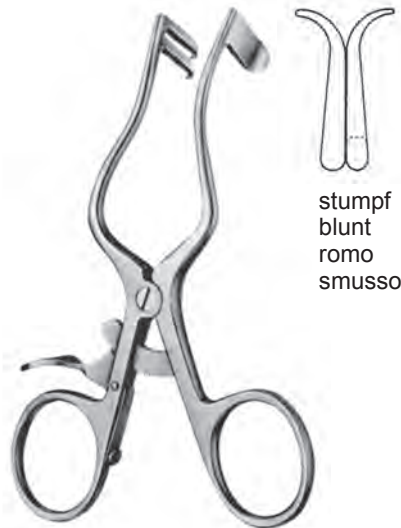

stumpf  
blunt  
romo  
smusso

PLESTER  
19672-11 11 cm, 4 3/8"

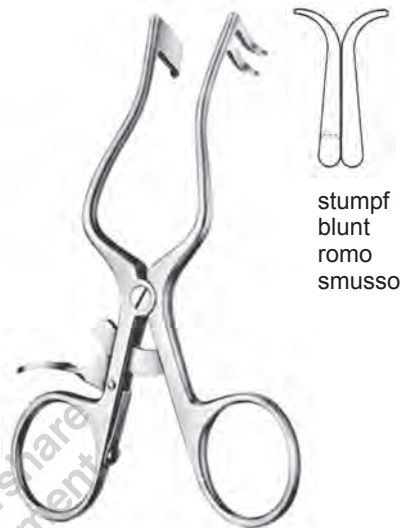

stumpf  
blunt  
romo  
smusso

PLESTER  
19673-11 11 cm, 4 3/8"

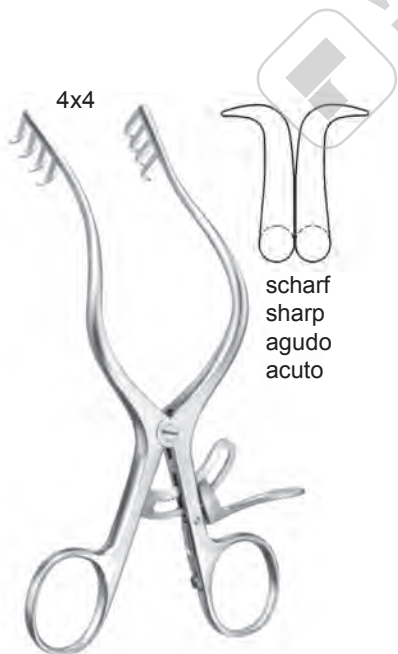

4x4

scharf  
sharp  
agudo  
acuto

MOLLISON  
19674-15 15 cm, 6"



3x3

stumpf  
blunt  
romo  
smusso

WULLSTEIN  
19675-13 13 cm, 5 1/8"

**Wundspreizer**  
**Self-retaining Retractors**  
**Separadores autoestáticos**  
**Divaricatori autostatici**

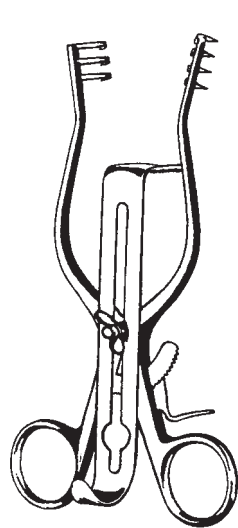

**HENLEY**  
16,5 cm, 6 1/2"



19675-00 komplett, stumpf, 3x4 Z. und 3 Valven  
19675-00 complete, blunt, 3x4 teeth and 3 blades  
19675-00 completo, romo, 3x4 dientes y 3 valvas  
19675-00 completo, smusso, 3x4 d. e 3 valve

19676-00 komplett, scharf, 3x4 Z. und 3 Valven  
19676-00 complete, sharp, 3x4 teeth and 3 blades  
19676-00 completo, agudo, 3x4 dientes y 3 valvas  
19676-00 completo con retr. acuto 3x4 d. e 3 valve

19678-05 Retraktor allein, stumpf 3x4 Zähne  
19678-05 Retractor only, blunt 3x4 teeth  
19678-05 Separador solo, romo, 3x4 dientes  
19678-05 Retrattore solo, smusso 3x4 denti

19678-06 Retraktor allein, scharf 3x4 Zähne  
19678-06 Retractor only, sharp 3x4 teeth  
19678-06 Separador solo, agudo, 3x4 dientes  
19678-06 Retrattore solo, acuto 3x4 denti



19677-19  
16x19 mm  
5/8" x 3/4"

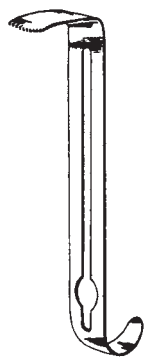

19677-25  
16x25 mm  
5/8" x 1"

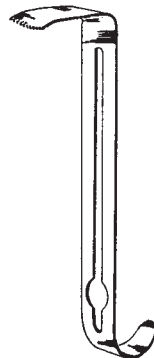

19677-32  
16x32 mm  
5/8" x 1 1/4"

**HADEO**  
INSTRUMENTE GERMANY

Wundspreizer  
Self-retaining Retractors  
Separadores autoestáticos  
Divaricatori autostatici



PLESTER  
19677-13 13 cm, 5 1/8"

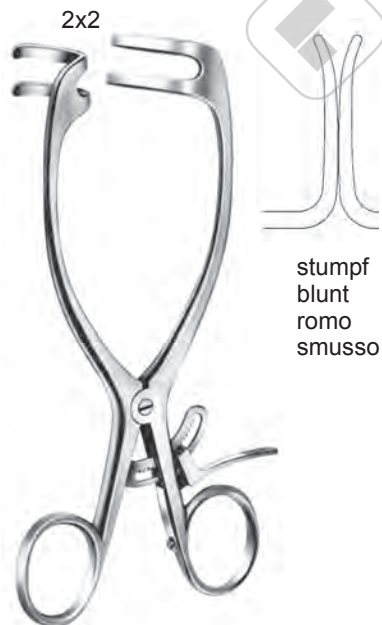

MAYO-ADAMS  
19678-16 16,5 cm, 6 1/2"

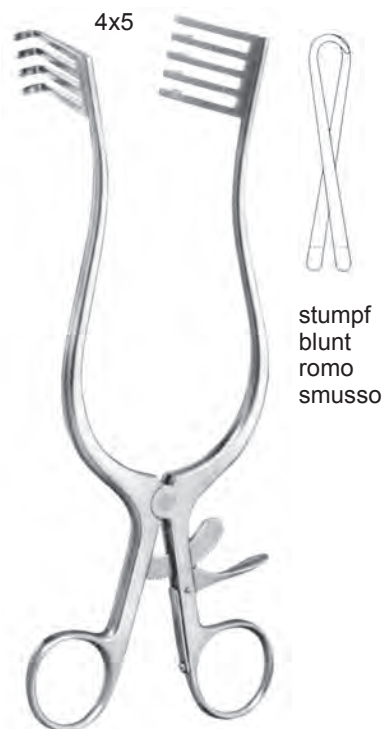

NORFOLK / NORWICH  
19679-22 22 cm, 8 3/4"

**HADEO**  
INSTRUMENTE GERMANY

Wundspreizer  
Self-retaining Retractors  
Separadores autoestáticos  
Divaricatori autostatici

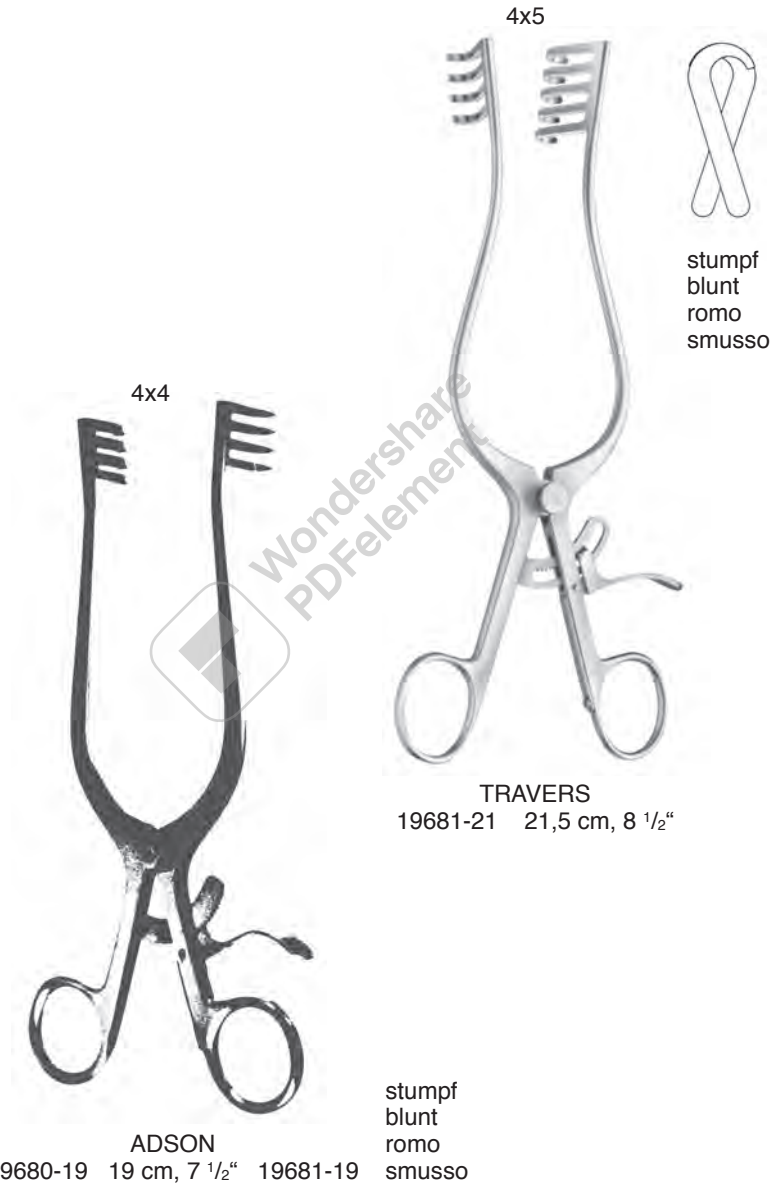

**HADEO**  
INSTRUMENTE GERMANY

Wundspreizer  
Self-retaining Retractors  
Separadores autoestáticos  
Divaricatori autostatici

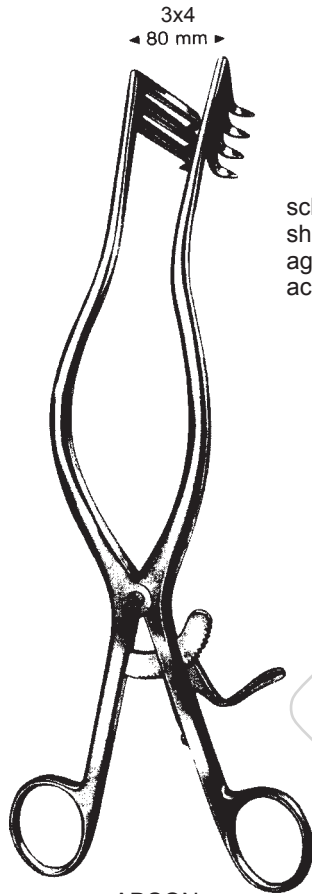

ADSON  
26,5 cm, 10 1/2"

scharf  
sharp  
agudo  
acuto

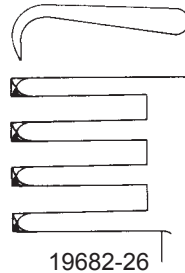

19682-26

stumpf  
blunt  
romo  
smusso

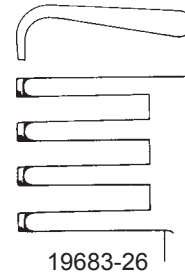

19683-26

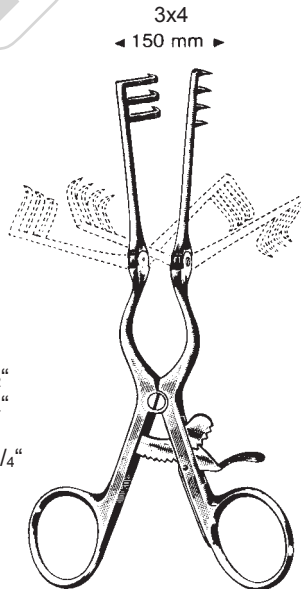

BECKMANN-ADSON (CONE)

- 19684-14 14 cm, 5 1/2"
- 19684-16 16 cm, 6 1/4"
- 19684-20 20 cm, 8"
- 19684-26 26 cm, 10 1/4"

scharf  
sharp  
agudo  
acuto

- 19685-14 14 cm, 5 1/2"
- 19685-16 16 cm, 6 1/4"
- 19685-20 20 cm, 8"
- 19685-26 26 cm, 10 1/4"

stumpf  
blunt  
romo  
smusso

**HADEO**  
INSTRUMENTE GERMANY

Kopfhautspreizer  
Scalp Retractor  
Separador para el cuero cabelludo  
Divaricatore automatico per cuoio capelluto

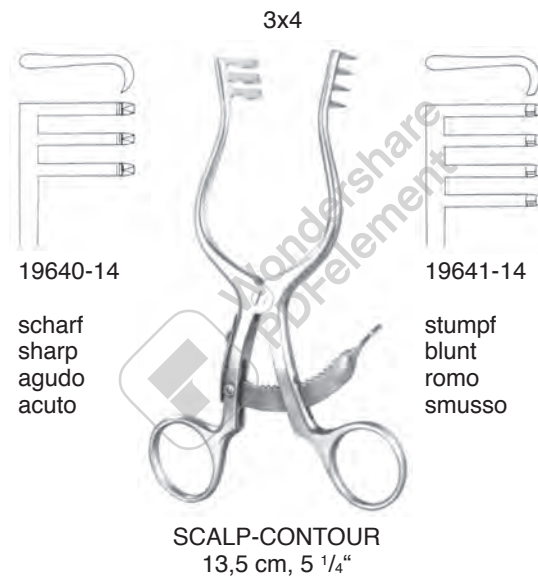

**HADEO**  
INSTRUMENTE GERMANY

Zerebellum-Spreizer  
Cerebellar Retractor  
Separador para cerebello  
Divaricatore per cervelletto

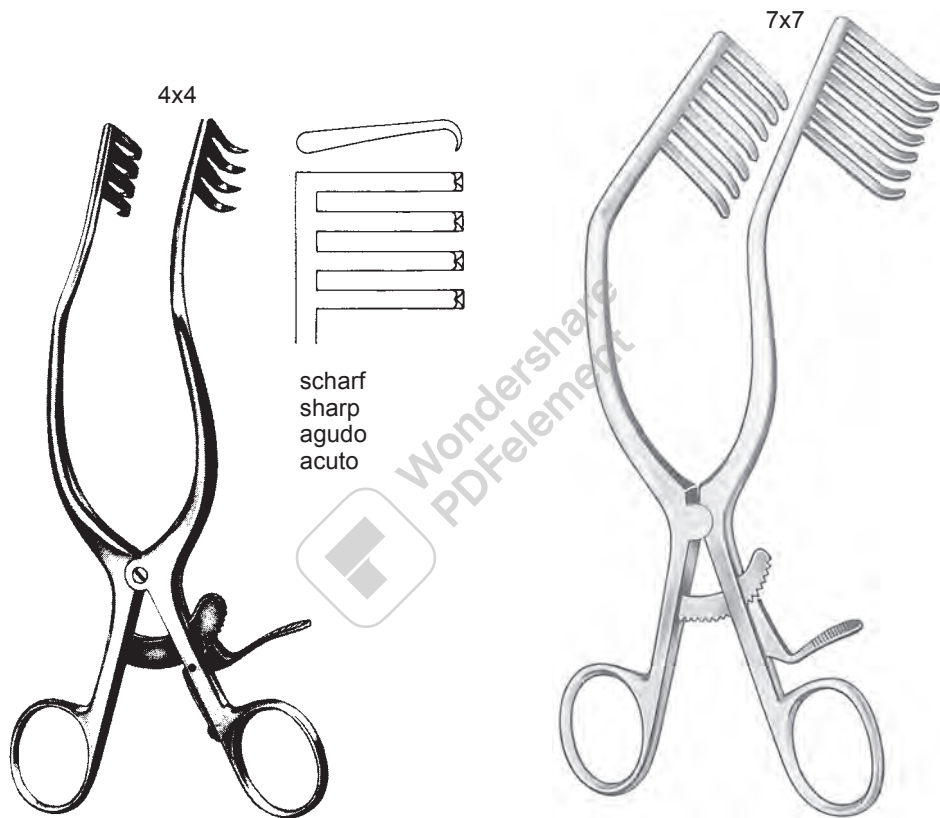

ANDERSON ADSON  
19679-20 19,5 cm, 7 3/4"

MISKIMON  
22 cm, 8 3/4"

19693-01	19693-02
scharf	stumpf
sharp	blunt
agudo	romo
acuto	smusso



**HADEO**  
INSTRUMENTE GERMANY

Laminektomie-Wundspreizer  
Laminectomy Retractors  
Separadores para laminectomía  
Divaricatori per laminectomia

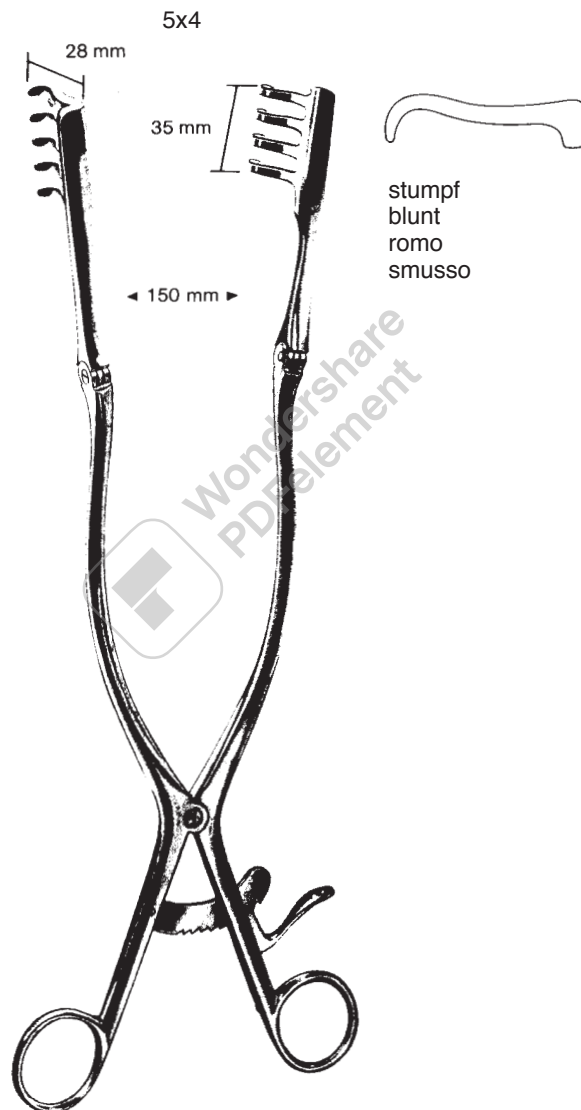

ADSON  
19686-32  
32 cm, 12 <sup>3</sup>/<sub>4</sub>"

**HADEO**  
INSTRUMENTE GERMANY

Laminektomie-Wundspreizer  
Laminectomy Retractors  
Separadores para laminectomía  
Divaricatori per laminectomia

4x4

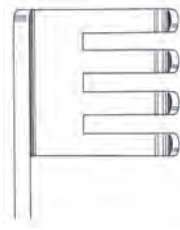

19687-01  
25 x 27 mm  
stumpf  
blunt  
romo  
smusso

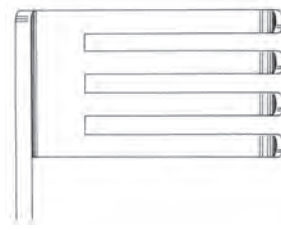

19688-01  
45 x 27 mm  
stumpf  
blunt  
romo  
smusso



19687-02  
25 x 27 mm  
scharf  
sharp  
agudo  
acuto

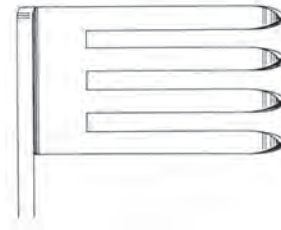

19688-02  
45 x 27 mm  
scharf  
sharp  
agudo  
acuto

BECKMANN-ADSON  
31 cm, 12 1/4"

**HADEO**  
INSTRUMENTE GERMANY

Laminektomie-Wundspreizer  
Laminectomy Retractors  
Separadores para laminectomía  
Divaricatori per laminectomia

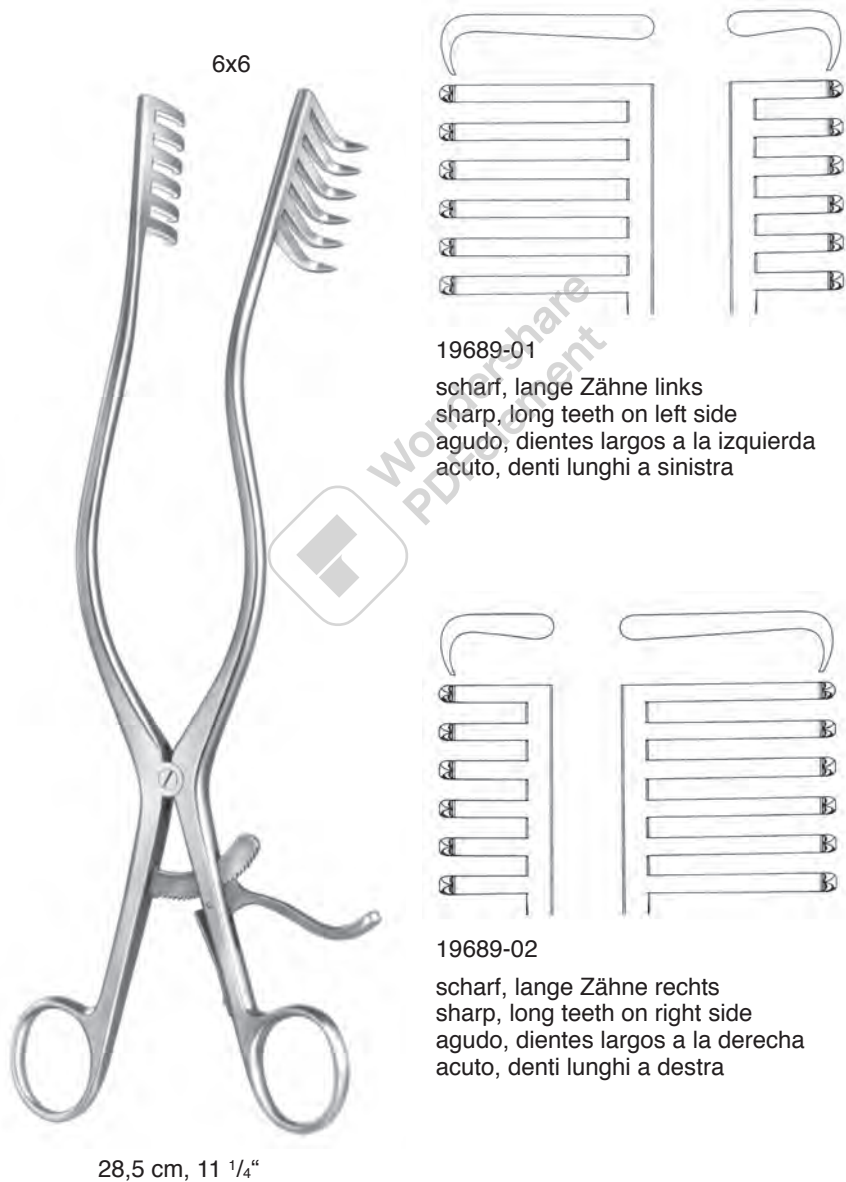

**HADEO**  
INSTRUMENTE GERMANY

Laminektomie-Wundspreizer  
Laminectomy Retractors  
Separadores para laminectomía  
Divaricatori per laminectomia

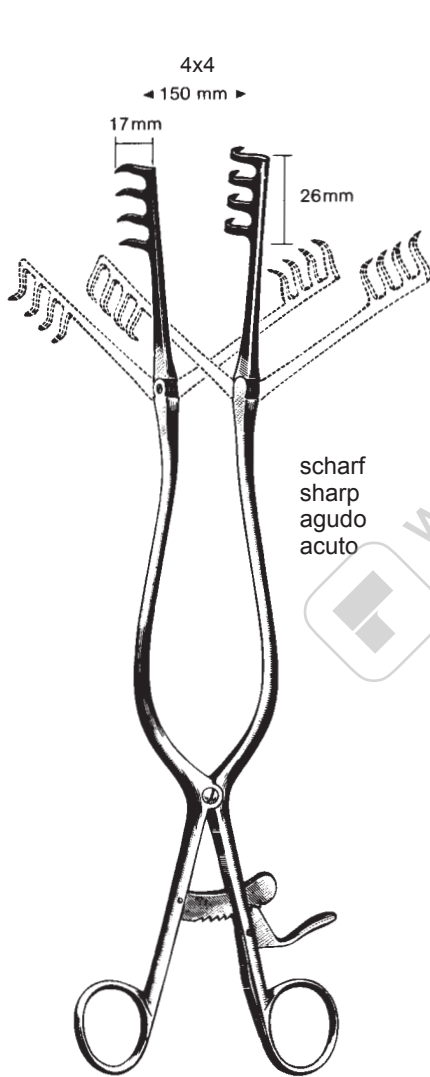

scharf  
sharp  
agudo  
acuto

BECKMANN  
19690-31  
31 cm, 12 1/4"

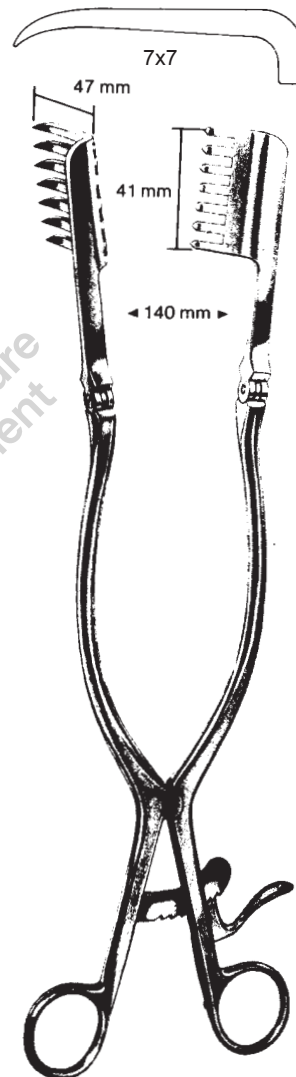

scharf  
sharp  
agudo  
acuto

BECKMANN-EATON  
19692-32  
32 cm, 12 3/4"

**HADEO**  
INSTRUMENTE GERMANY

Laminektomie-Wundspreizer  
Laminectomy Retractors  
Separadores para laminectomía  
Divaricatori per laminectomia

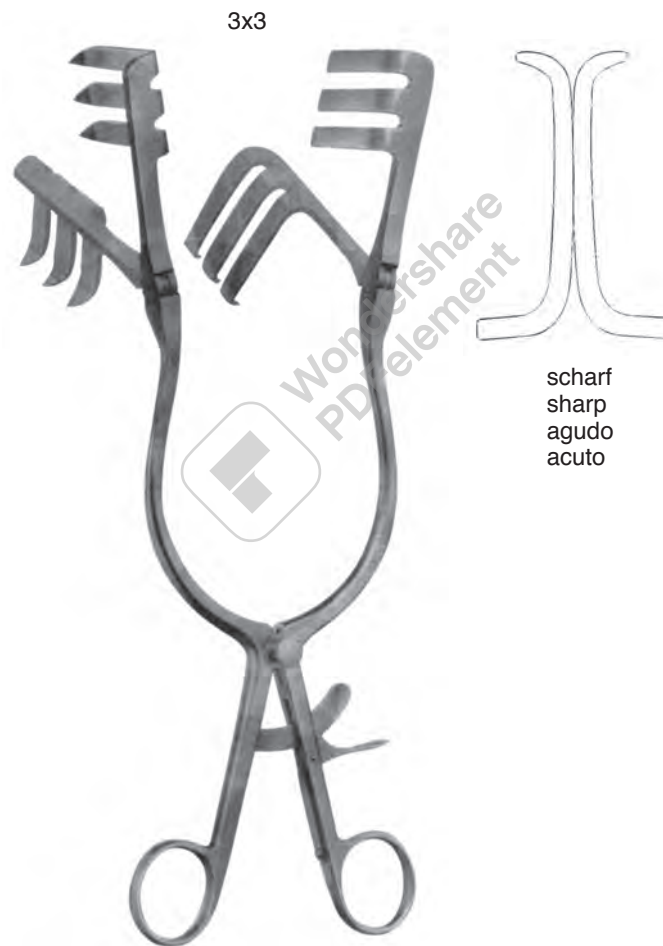

HARVEY-JACKSON  
19693-28  
28 cm, 11"

**HADEO**  
INSTRUMENTE GERMANY

Laminektomie-Wundspreizer  
Laminectomy Retractors  
Separadores para laminectomía  
Divaricatori per laminectomia

Blätter rechts  
blades right hand side  
valvas a la derecha  
Lame destra



KNIGHTON  
19694-18  
18 cm, 7"

Blätter links  
blades left hand side  
valvas a la izquierda  
Lame sinistra



KNIGHTON  
19695-18  
18 cm, 7"

**HADEO**  
INSTRUMENTE GERMANY

Laminektomie-Wundspreizer  
Laminectomy Retractors  
Separadores para laminectomía  
Divaricatori per laminectomia

Blätter rechts  
blades right hand side  
valvas a la derecha  
Lame destra



WALTON  
19695-01  
18 cm, 7"

Blätter links  
blades left hand side  
valvas a la izquierda  
Lame sinistra



WALTON  
19695-02  
18 cm, 7"



Laminektomie-Wundspreizer  
 Laminectomy Retractors  
 Separadores para laminectomía  
 Divaricatori per laminectomia



19770-00 CASPAR  
 Sperrer mit Haken 19772-38 und  
 5 Blättern 19774-37 - 19774-57  
 Retractor with hook 19772-38 and  
 5 blades 19774-37 - 19774-57  
 Retractor con gancho 19772-38 y  
 5 hojas 19774-37 - 19774-57  
 Divaricatore con gancio 19772-38 e  
 5 valve 19774-37 - 19774-57

19770-11  
 Sperrer, alleine  
 Retractor, only  
 Retractor, suelto  
 Divaricatore solo



19779-00  
 Drehschlüssel alleine  
 Key only  
 Llave sola  
 Chiave sola



19772-38 Haken 38 mm  
 Hook 38 mm  
 gancho de 38 mm  
 gancio 38 mm

19772-58 Haken 58 mm  
 Hook 58 mm  
 gancho de 58 mm  
 gancio 58 mm



19774-32 32 x 22 mm  
 19774-37 37 x 22 mm  
 19774-43 43 x 22 mm  
 19774-47 47 x 22 mm  
 19774-52 52 x 22 mm  
 19774-57 57 x 22 mm  
 19774-62 62 x 22 mm  
 19774-67 67 x 22 mm

Blätter / blades  
 hojas / valve



19776-32 32 x 37 mm  
 19776-37 37 x 37 mm  
 19776-43 43 x 37 mm  
 19776-47 47 x 37 mm  
 19776-52 52 x 37 mm  
 19776-57 57 x 37 mm  
 19776-62 62 x 37 mm  
 19776-67 67 x 37 mm

Blätter / blades  
 hojas / valve



19778-32 32 x 52 mm  
 19778-37 37 x 52 mm  
 19778-43 43 x 52 mm  
 19778-47 47 x 52 mm  
 19778-52 52 x 52 mm  
 19778-57 57 x 52 mm  
 19778-62 62 x 52 mm  
 19778-67 67 x 52 mm

Blätter / blades  
 hojas / valve



**HADEO**  
INSTRUMENTE GERMANY

Laminektomiespreizer  
Laminectomy Retractors  
Separadores para laminectomia  
Divaricatori per laminectomia

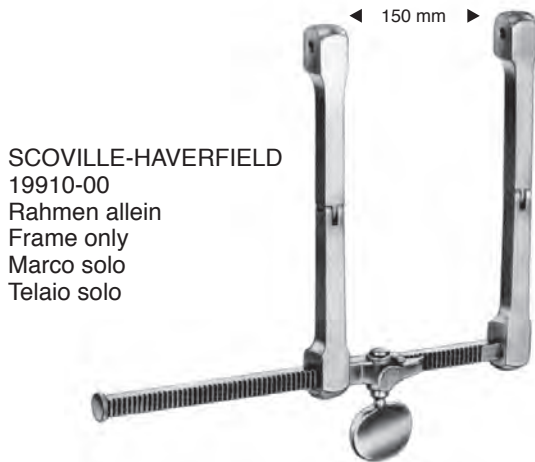

SCOVILLE-HAVERFIELD  
19910-00  
Rahmen allein  
Frame only  
Marco solo  
Telaio solo



SCOVILLE  
19911-00  
Rahmen allein  
Frame only  
Marco solo  
Telaio solo

SCOVILLE-HAVERFIELD  
19910-01  
komplett bestehend aus:  
complete consisting of:  
completo con:  
completo con:  
19910-00 + 19913-50 + 19917-64

SCOVILLE  
19911-01  
komplett bestehend aus:  
complete consisting of:  
completo con:  
completo con:  
19911-00 + 19913-50 + 19917-64



SCOVILLE  
19912-50  
50 mm



SCOVILLE  
19912-70  
70 mm



SCOVILLE  
19914-41 41 x 38 mm  
19914-67 67 x 44 mm



TAYLOR  
19915-48 48 x 50 mm  
19915-64 64 x 50 mm  
19916-64 64 x 64 mm  
19916-80 80 x 57 mm



SCOVILLE  
19913-50  
50 mm



SCOVILLE  
19913-70  
70 mm



SCOVILLE  
19917-64 64 x 25 mm  
19918-64 64 x 50 mm  
19918-88 88 x 25 mm

**HADEO**  
INSTRUMENTE GERMANY

Laminektomiespreizer  
Laminectomy Retractors  
Separadores para laminectomia  
Divaricatori per laminectomia

62 x 52 mm      62 x 37 mm



19919-02  
1 Paar / 1 pair / 1 par / 1 paio



19919-03  
47 x 51 mm



19919-00  
Rahmen allein  
Frame only  
Marco solo  
Telaio solo

SCOVILLE-RICHTER  
19919-01  
komplett / complete / completo / completo



19919-04  
30 x 40 mm



19919-05  
37 x 62 mm

Rahmen mit 1 Paar Valven 19919-02  
frame with one pair of blades 19919-02  
marco con 1 par de valvas 19919-02  
divaricatore con valve 19919-02

**HADEO**  
INSTRUMENTE GERMANY

Laminektomie-Wundspreizer  
Laminectomy Retractors  
Separadores para laminectomía  
Divaricatori per laminectomia

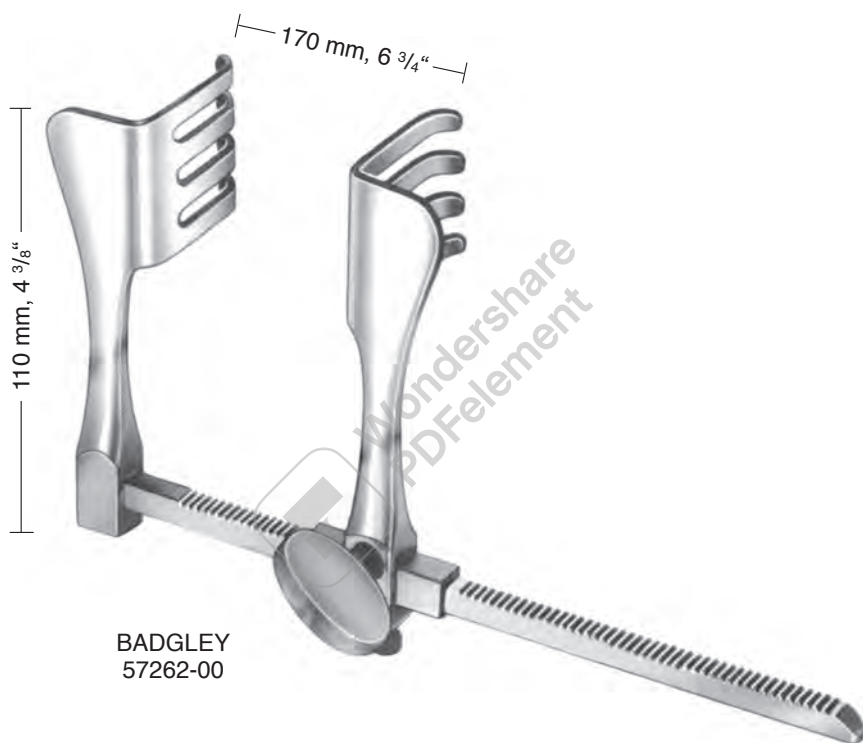

BADGLEY  
57262-00

# HADEO

INSTRUMENTE GERMANY

Cervicalspreizer  
Cervical Retractor  
Separador cervical  
Divaricatore cervicale

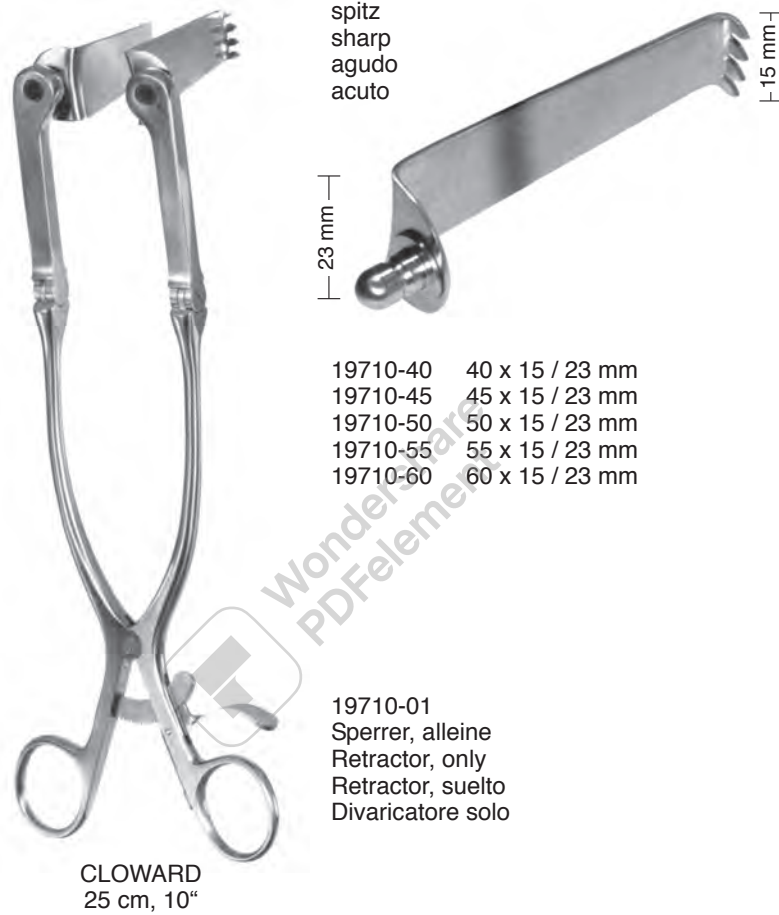

19710-00  
Sperrer komplett mit 5 Valven spitz  
Retractor complete with 5 blades sharp  
Separador completo con 5 valvas agudas  
Divaricatore completo con 5 valve acute

**HADEO**  
 INSTRUMENTE GERMANY

 Cervicalspreizer  
 Cervical Retractor  
 Separador cervical  
 Divaricatore cervicale

 CLOWARD  
 25 cm, 10"

 stumpf  
 blunt  
 romo  
 smusso

19711-40	40 x 15 / 23 mm
19711-45	45 x 15 / 23 mm
19711-50	50 x 15 / 23 mm
19711-55	55 x 15 / 23 mm
19711-60	60 x 15 / 23 mm

 19710-01  
 Sperrer, alleine  
 Retractor, only  
 Retractor, suelto  
 Divaricatore solo

 19712-00  
 Sperrer komplett mit 5 Valven stumpf  
 Retractor complete with 5 blades blunt  
 Separador completo con 5 valvas romas  
 Divaricatore completo con 5 valve smusse

# HADEO

INSTRUMENTE GERMANY

Cervicalspreizer  
Cervical Retractor  
Separador cervical  
Divaricatore cervicale



19710-40	40 x 15 / 23 mm
19710-45	45 x 15 / 23 mm
19710-50	50 x 15 / 23 mm
19710-55	55 x 15 / 23 mm
19710-60	60 x 15 / 23 mm



CLOWARD  
16 cm, 6 1/4"

19711-01  
Sperrer, alleine  
Retractor, only  
Retractor, suelto  
Divaricatore solo

19711-00  
Sperrer komplett mit 5 Valven spitz  
Retractor complete with 5 blades sharp  
Separador completo con 5 valvas agudas  
Divaricatore completo con 5 valve acute

**HADEO**  
 INSTRUMENTE GERMANY

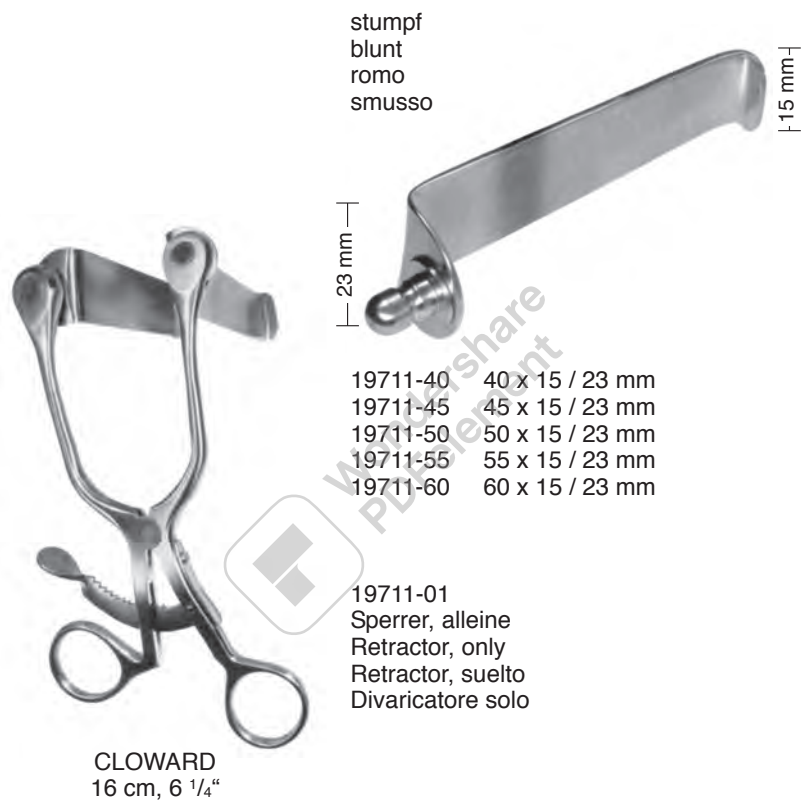
 Cervicalspreizer  
 Cervical Retractor  
 Separador cervical  
 Divaricatore cervicale

19713-00  
Sperrer komplett mit 5 Valven stumpf  
Retractor complete with 5 blades blunt  
Separador completo con 5 valvas romas  
Divaricatore completo con 5 valve smusse

**HADEO**  
INSTRUMENTE GERMANY

Cervicalspreizer  
Cervical Retractor  
Separador cervical  
Divaricatore cervicale

90 mm, 3 1/2"



CASPAR  
19721-15  
165 mm, 5 1/2"

Sperrer, alleine  
Retractor, only  
Retractor, suelto  
Divaricatore solo



19726-01

Blätter-Wechselpinzette  
Blade ejector  
Pinza para cambiar hojas  
Pinze per cambiare valve

19721-00 compl.  
5 Valven / 5 blades / 5 valvas / 5 valve  
Blätter, stumpf / blunt blades, only stainless steel /  
hojas romas de acero inox. / valve smusse di acciaio inox

19738-45 45 x 23 mm  
19738-50 50 x 23 mm  
19738-55 55 x 23 mm  
19738-60 60 x 23 mm  
19738-65 65 x 23 mm





**HADEO**  
INSTRUMENTE GERMANY

Titan Blätter, gefenstert  
Titanium blades, fenestrated  
Valvas de titanio, fenestradas  
Valve de titanio, fenestrada

- 19 mm x 25 mm 19727-25T
- 19 mm x 30 mm 19727-30T
- 19 mm x 35 mm 19727-35T
- 19 mm x 40 mm 19727-40T
- 19 mm x 45 mm 19727-45T
- 19 mm x 50 mm 19727-50T
- 19 mm x 55 mm 19727-55T
- 19 mm x 60 mm 19727-60T

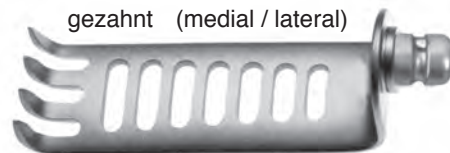

- 19 mm x 25 mm 19728-25T
- 19 mm x 30 mm 19728-30T
- 19 mm x 35 mm 19728-35T
- 19 mm x 40 mm 19728-40T
- 19 mm x 45 mm 19728-45T
- 19 mm x 50 mm 19728-50T
- 19 mm x 55 mm 19728-55T
- 19 mm x 60 mm 19728-60T

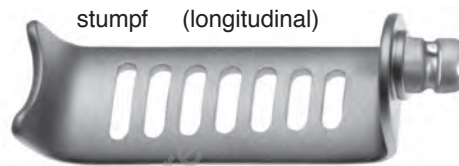

- 24 mm x 30 mm 19729-30T
- 24 mm x 35 mm 19729-35T
- 24 mm x 40 mm 19729-40T
- 24 mm x 45 mm 19729-45T
- 24 mm x 50 mm 19729-50T
- 24 mm x 55 mm 19729-55T
- 24 mm x 60 mm 19729-60T
- 24 mm x 65 mm 19729-65T
- 24 mm x 70 mm 19729-70T

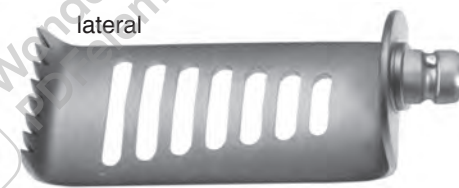

- 24 mm x 30 mm 19730-30T
- 24 mm x 35 mm 19730-35T
- 24 mm x 40 mm 19730-40T
- 24 mm x 45 mm 19730-45T
- 24 mm x 50 mm 19730-50T
- 24 mm x 55 mm 19730-55T
- 24 mm x 60 mm 19730-60T
- 24 mm x 65 mm 19730-65T
- 24 mm x 70 mm 19730-70T

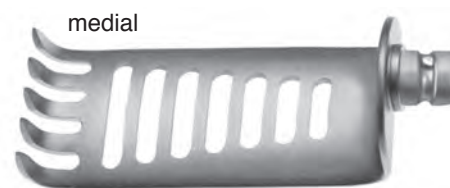

- 24 mm x 35 mm 19731-35T
- 24 mm x 40 mm 19731-40T
- 24 mm x 45 mm 19731-45T
- 24 mm x 50 mm 19731-50T
- 24 mm x 55 mm 19731-55T
- 24 mm x 60 mm 19731-60T
- 24 mm x 65 mm 19731-65T
- 24 mm x 70 mm 19731-70T
- 24 mm x 75 mm 19731-75T

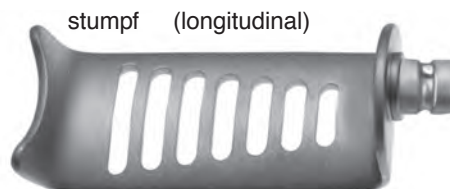

# HADEO

INSTRUMENTE GERMANY

Blätter für Cervicalspreizer  
Blades for cervical Retractors  
Hojas sueltas para separador cervical  
Valve per divaricatori cervicale



19724-55  
55 x 20 mm

Blätter, medial / medial blades, only stainless steel /  
hojas mediales de acero inox. / valve mediali di acciaio inox

19724-40	40 x 23 mm	19724-55	55 x 23 mm
19724-45	45 x 23 mm	19724-60	60 x 23 mm
19724-50	50 x 23 mm		

Blätter, medial, TITAN / medial blades, only, TITANIUM /  
hojas mediales de TITANIO / valve mediali di TITANIO

19732-25 T	25 x 24 mm	19732-50 T	50 x 24 mm
19732-30 T	30 x 24 mm	19732-55 T	55 x 24 mm
19732-35 T	35 x 24 mm	19732-60 T	60 x 24 mm
19732-40 T	40 x 24 mm	19732-65 T	65 x 24 mm
19732-45 T	45 x 24 mm	19732-70 T	70 x 24 mm



19734-50  
50 x 23 mm

Blätter, lateral / lateral blades, only stainless steel /  
hojas laterales de acero inox. / valve laterali di acciaio inox

19725-40	40 x 23 mm	19725-55	55 x 23 mm
19725-45	45 x 23 mm	19725-60	60 x 23 mm
19725-50	50 x 23 mm		

Blätter, lateral, TITAN / lateral blades, only, TITANIUM /  
hojas laterales de TITANIO / valve laterali di TITANIO

19736-25 T	25 x 24 mm	19736-50 T	50 x 24 mm
19736-30 T	30 x 24 mm	19736-55 T	55 x 24 mm
19736-35 T	35 x 24 mm	19736-60 T	60 x 24 mm
19736-40 T	40 x 24 mm	19736-65 T	65 x 24 mm
19736-45 T	45 x 24 mm	19736-70 T	70 x 24 mm



19738-55  
55 x 23 mm

Blätter, stumpf / blunt blades, only stainless steel /  
hojas romas de acero inox. / valve smusse di acciaio inox

19738-45	45 x 23 mm	19738-60	60 x 23 mm
19738-50	50 x 23 mm	19738-65	65 x 23 mm
19738-55	55 x 23 mm		

Blätter, stumpf, TITAN / blunt blades, only, TITANIUM /  
hojas romas de TITANIO / valve smusse di TITANIO

19739-30 T	30 x 24 mm	19739-55 T	55 x 24 mm
19739-35 T	35 x 24 mm	19739-60 T	60 x 24 mm
19739-40 T	40 x 24 mm	19739-65 T	65 x 24 mm
19739-45 T	45 x 24 mm	19739-70 T	70 x 24 mm
19739-50 T	50 x 24 mm	19739-75 T	75 x 24 mm



Blätter, stumpf / blunt blades, only stainless steel /  
hojas romas de acero inox. / valve smusse di acciaio inox

19740-50	50 x 25 mm
19740-60	60 x 25 mm

**HADEO**  
INSTRUMENTE GERMANY

Hemilaminektomiespreizer  
Hemilaminectomy Retractor  
Separadores para hemilaminectomía  
Divaricatori per emilaminectomia



DARLING  
19696-18 18 cm, 7"

links  
left  
a la izquierda  
a sinistra

DARLING  
19698-18 18 cm, 7"

rechts  
right  
a la derecha  
a destra

**HADEO**  
INSTRUMENTE GERMANY

Hemilaminectomiespreizer  
Hemilaminectomy Retractor  
Separadores para hemilaminectomía  
Divaricatori per emilaminectomia

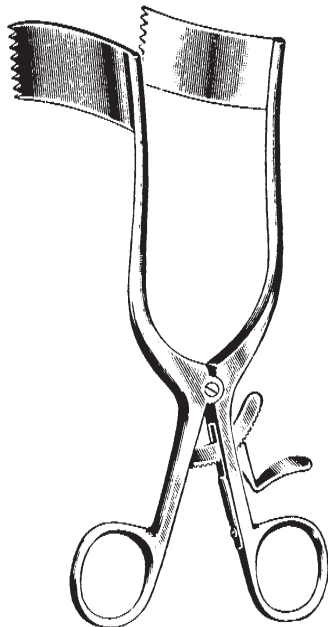
**MEYERDING**

17 cm, 6 3/4"

19748-01 2,5 x 3,2 cm  
19748-02 2,5 x 5,4 cm  
19748-03 1,9 x 6,0 cm  
19748-04 2,5 x 6,0 cm

**MARKHAM-MEYERDING**

19749-01

18 cm, 7"

**MARKHAM-MEYERDING**

19749-02

18 cm, 7"

**HADEO**  
INSTRUMENTE GERMANY

Hemilaminectomiespreizer  
Hemilaminectomy Retractor  
Separadores para hemilaminectomía  
Divaricatori per emilaminectomia



**WILLIAMS**  
20 cm, 8"

- |            |          |
|------------|----------|
| 50 x 10 mm | 19750-01 |
| 60 x 10 mm | 19750-02 |
| 70 x 10 mm | 19750-03 |
| 50 x 20 mm | 19750-04 |
| 60 x 20 mm | 19750-05 |
| 70 x 20 mm | 19750-06 |

links  
left  
a la izquierda  
a sinistra



**WILLIAMS**  
20 cm, 8"

- |            |          |
|------------|----------|
| 50 x 10 mm | 19751-01 |
| 60 x 10 mm | 19751-02 |
| 70 x 10 mm | 19751-03 |
| 50 x 20 mm | 19751-04 |
| 60 x 20 mm | 19751-05 |
| 70 x 20 mm | 19751-06 |

rechts  
right  
a la derecha  
a destra

**HADEO**  
INSTRUMENTE GERMANY

Wundspreizer  
Retractors  
Separadores  
Divaricatori

&lt; 100 mm &gt;

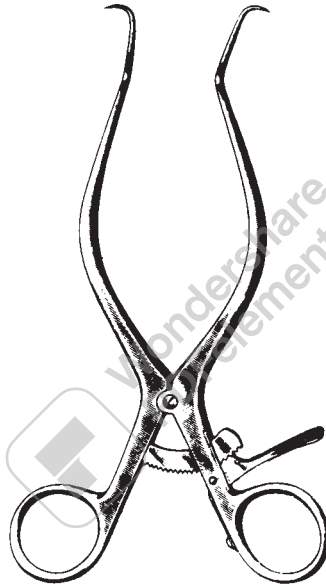
**GELPI**

19802-09	9 cm, 3 1/2"
19802-11	11 cm, 4 3/8"
19802-14	14 cm, 5 1/2"
19802-16	16 cm, 6 1/4"
19802-18	18 cm, 7"

**HADEO**  
INSTRUMENTE GERMANY

Lamina Spreizer  
Lamina Retractor  
Separadores para vertebrales  
Separatori per vertebre



CLOWARD  
41401-16  
16 cm, 6 1/4"

**HADEO**  
INSTRUMENTE GERMANY

Lamina Spreizer  
Lamina Retractor  
Separadores para vertebrales  
Separatori per vertebre

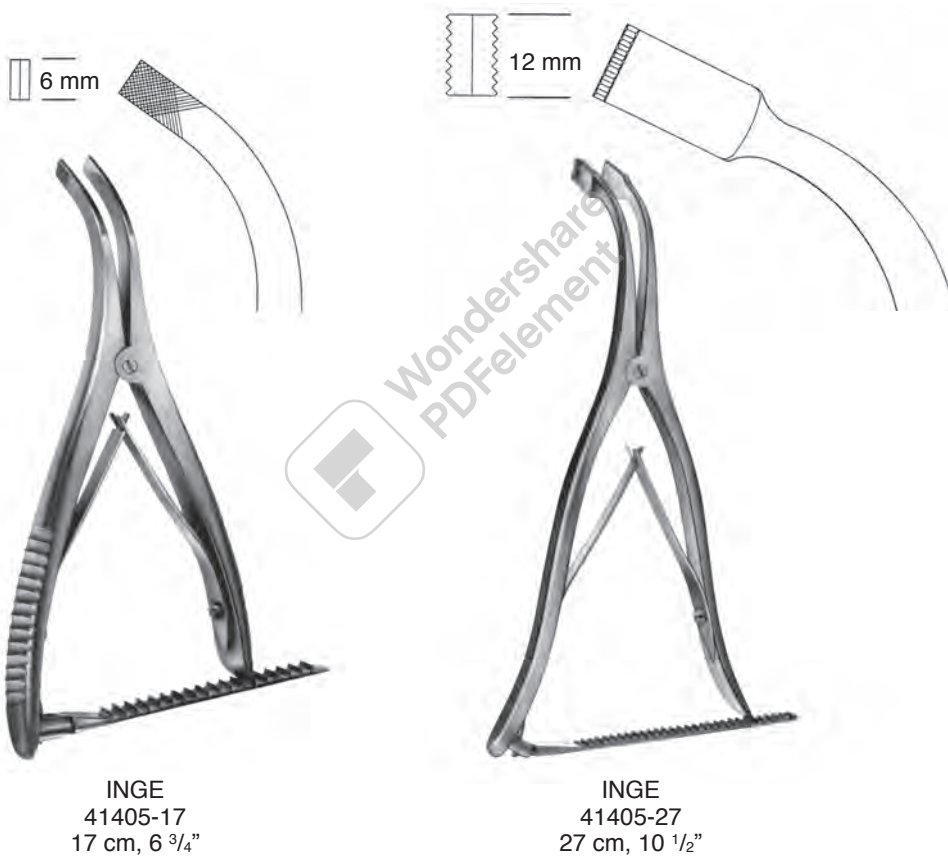



**HADEO**  
INSTRUMENTE GERMANY

Lamina Spreizer  
Lamina Retractor  
Separadores para vertebrales  
Separatori per vertebre



CLOWARD  
41406-01  
12,5 cm, 5"



CLOWARD  
41406-02  
7,6 cm, 3"

**HADEO**  
INSTRUMENTE GERMANY

Lumbal-Wundspreizer  
Lumbal Retractors  
Separadores lumbales autoestáticos  
Divaricatori autostatici lombari

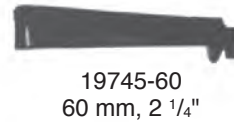
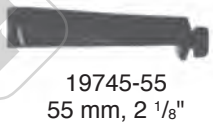
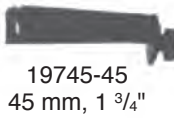

CASPAR  
19744-00  
compl. incl. 7 Blätter  
compl. incl. 7 blades  
completo con 7 valvas  
complete di 7 valve

19744-17  
ohne Blätter  
without blades  
sin valvas  
senza valve

**HADEO**  
INSTRUMENTE GERMANY

Spekula für lumbale Bandscheibenoperationen  
Specula for lumbar operations  
Especulas para operaciones lumbales  
Specolo per ernia discale lombare



CASPAR

19748-40	40 mm / 1 1/2"
19748-45	45 mm / 1 3/4"
19748-50	50 mm / 2"
19748-55	55 mm / 2 1/8"
19748-60	60 mm / 2 1/4"
19748-65	65 mm / 2 1/2"
19748-70	70 mm / 2 3/4"
19748-75	75 mm / 3"
19748-85	85 mm / 3 1/4"



**HADEO**  
INSTRUMENTE GERMANY

Lumbal-Wundspreizer  
Lumbal Retractors  
Separadores lumbales autoestáticos  
Divaricatori autostatici lombari

19726-01 Blätter-Wechselpinzette  
Blade ejector  
Pinza para cambiar hojas  
Pinze per cambiare valve



60 mm



CASPAR

100 mm

19742-35 35 mm  
19742-40 40 mm  
19742-45 45 mm  
19742-50 50 mm  
19742-55 55 mm  
19742-60 60 mm



Valven, lateral / blades, lateral  
valvas, laterales / valve, laterali

19930-00 Gegensperrer, komplett mit 6 Blättern  
Counter Retractor, complete with 6 blades  
Contra-retractor, completo, con 6 hojas  
Divaricatore completo di 6 valve

19930-01 Gegensperrer, alleine  
Counter Retractor, only  
Contra-retractor, suelto  
Divaricatore solo

**HADEO**  
INSTRUMENTE GERMANY**Lumbal-Wundspreizer  
Lumbal Retractors  
Separadores lumbal  
Divaricatore lombare**

19742-35	35 mm / 1 1/4"
19742-40	40 mm / 1 1/2"
19742-45	45 mm / 1 3/4"
19742-50	50 mm / 2"
19742-55	55 mm / 2 1/8"
19742-60	60 mm / 2 1/4"
19742-65	65 mm / 2 1/2"
19742-75	75 mm / 3"
19742-85	85 mm / 3 1/4"

Blätter alleine, lateral  
blades only, lateral  
hojas sueltas, lateral  
valve sole, laterale



19743-35	35 mm / 1 1/4"
19743-40	40 mm / 1 1/2"
19743-45	45 mm / 1 3/4"
19743-50	50 mm / 2"
19743-55	55 mm / 2 1/8"
19743-60	60 mm / 2 1/4"
19743-65	65 mm / 2 1/2"

Blätter alleine, medial  
blades only, medial  
hojas sueltas, medial  
valve sole, mediali

**HADEO**  
INSTRUMENTE GERMANY

Cervicales Wirbelkörper Distraktions System  
Cervical Vertebral Body Distraction System  
Cervical Sistema de distracción vertebral  
Sistema di distrazione vertebrale cervicale



- 19920-01 Distraktor alleine, rechts  
Distractor only, right  
Distractor suelto, lado derecho  
Distrattore solo, a destra
- 19920-02 Distraktor alleine, links  
Distractor only, left  
Distractor suelto, lado izquierdo  
Distrattore solo, a sinistra
- 19930-03 Distraktor alleine, rechts mit verlängerter Führungsstange für mehrere Distraktionen  
Distractor only, right with elongated toothed bar for multilevel distraction  
Distractor suelto, lado derecho, con guía alargada para distracciones multiples  
Distrattore solo, a destra, allungato, per multi-distrazioni
- 19930-02 Distraktor alleine, links  
Distractor only, left  
Distractor suelto, lado izquierdo  
Distrattore solo, a sinistra

**HADEO**  
INSTRUMENTE GERMANY

Cervicales Wirbelkörper Distraktions System  
Cervical Vertebral Body Distraction System  
Cervical Sistema de distracción vertebral  
Sistema di distrazione vertebrale cervicale



19940-01

**19940-01**

Bohrlehre, rechts, für Distraktor 19920-01 + 19930-01  
Drill guide, right, for distractor 19920-01 + 19930-01  
Guía, lado derecho, para distractor 19920-01 + 19930-01  
Guida a destra per distrattore 19920-01 + 19930-01

**19940-02**

Bohrlehre, links, für Distraktor 19920-02 + 19930-02  
Drill guide, left, for distractor 19920-02 + 19930-02  
Guía, lado izquierdo, para distractor 19920-02 + 19930-02  
Guida a sinistra per distrattore 19920-02 + 19930-02

**HADEO**  
INSTRUMENTE GERMANY

Wirbelkörper Distraktions System  
Vertebral Body Distraction System  
Sistema de distracción vertebral  
Sistema di distrazione vertebrale



Bohrer Ø 1,7 mm  
für Distraktionsschrauben  
Bohrtiefe 8 mm  
Twist drill Ø 1,7 mm  
for distraction screws  
drilling depth: 8 mm  
perforador Ø 1,7 mm  
para tornillos de distracción  
profundidad de 8 mm  
perforatore Ø 1,7 mm  
per viti di distrazione  
profondità 8 mm

19950-14  
145 mm  
5 3/4"



Schraubendreher  
für Distraktionsschrauben  
Screw driver  
for distraction screws  
Atornillador  
para tornillos de distracción  
Cacciavite  
per viti di distrazione

19960-20  
200 mm  
8"



19970-12 12 mm  
19970-14 14 mm  
19970-16 16 mm  
19970-18 18 mm

Distraktionsschrauben  
Distraction screws  
Tornillos de distracción  
Vite distrattore



ZANGEN

FORCEPS

PINZAS

PINZE



[www.hadeo.co](http://www.hadeo.co)

**HADEO**  
INSTRUMENTE GERMANY

Hohlmeißelzangen  
Bone Rongeurs  
Pinzas-gubias  
Pinze sgorbie

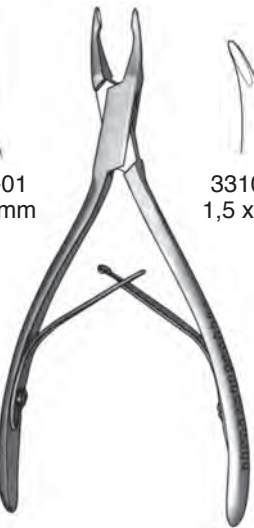
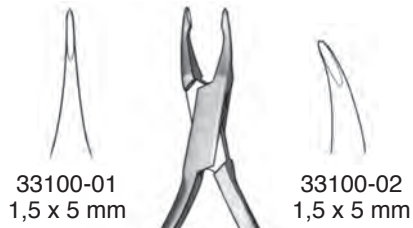

**MICRO FRIEDMAN**  
14 cm, 5 1/2"



**FRIEDMAN Mini**  
33101-12 12 cm, 4 3/4"



**FRIEDMAN**  
33101-14 14 cm, 5 1/2"

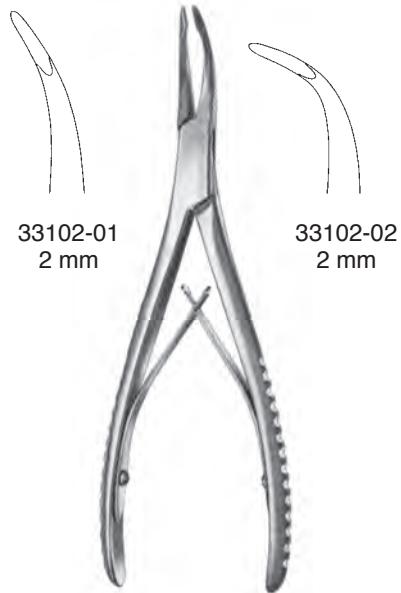

**STELLBRINK**  
17 cm, 6 3/4"

**HADEO**  
INSTRUMENTE GERMANY

Hohlmeißelzangen  
Bone Rongeurs  
Pinzas-gubias  
Pinze sgorbie



4,5 mm

LUER  
33131-15 15 cm, 5.9"

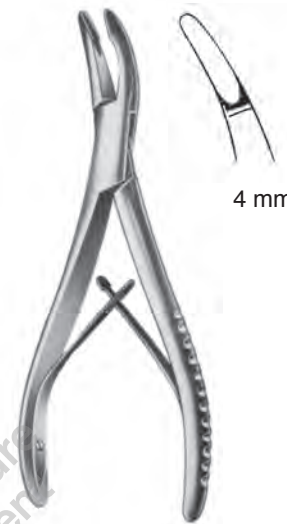

4 mm

LUER  
33133-15 15 cm, 5.9"

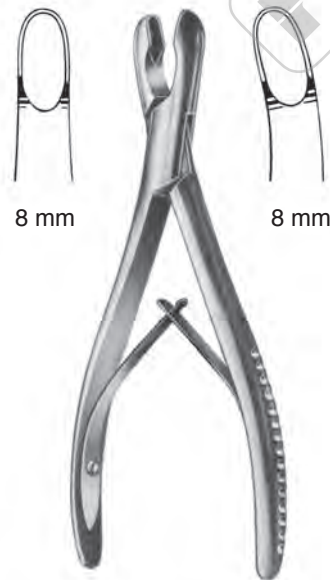

8 mm

8 mm

LUER  
33136-17 33137-17  
17 cm, 6 3/4"



9 mm

ADSON  
33142-20 33143-20  
20 cm, 7.9"

**HADEO**  
INSTRUMENTE GERMANY

Hohlmeißelzangen  
Bone Rongeurs  
Pinzas-gubias  
Pinze sgorbie



**OLIVECRONA**  
33147-20 20 cm, 7.9"

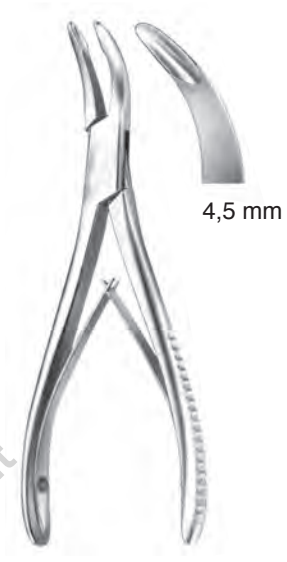

**BANE-HARTMANN**  
33148-18 17,5 cm, 7"



**LEMPERT**  
33150-16 33151-16  
16 cm, 6 1/4"



**JANSEN**  
33152-17 33153-17  
17 cm, 6 3/4"

**HADEO**  
INSTRUMENTE GERMANY

Hohlmeißelzangen  
Bone Rongeurs  
Pinzas-gubias  
Pinze sgorbie



LEMPERT  
33154-18 33155-18  
18,5 cm, 7 1/4"



BEYER  
33156-18  
18 cm, 7"

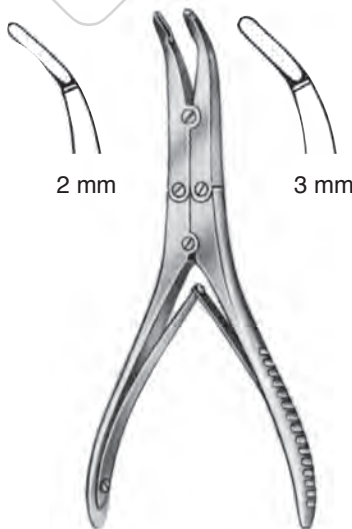

KLEINERT-KUTZ  
33157-02 33157-03  
15 cm, 6"

**HADEO**  
INSTRUMENTE GERMANY

Hohlmeißelzangen  
Bone Rongeurs  
Pinzas-gubias  
Pinze sgorbie

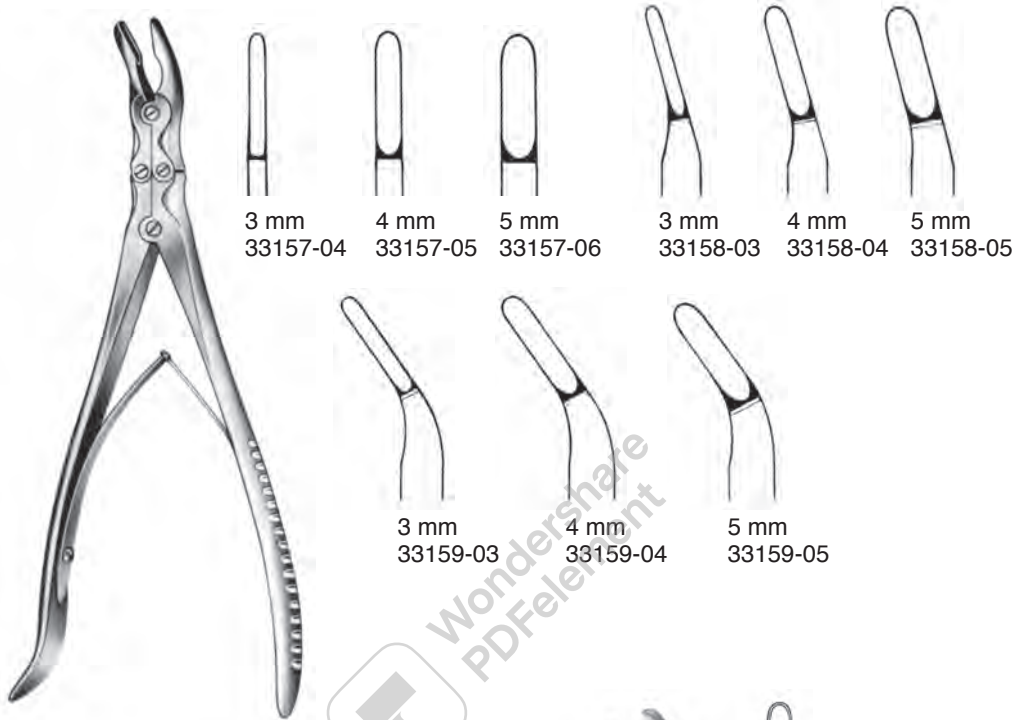

3 mm 33157-04    4 mm 33157-05    5 mm 33157-06    3 mm 33158-03    4 mm 33158-04    5 mm 33158-05

3 mm 33159-03    4 mm 33159-04    5 mm 33159-05

**SMITH-PETERSEN**  
24 cm, 9 1/2"



**BACON**  
33159-20  
20 cm, 8"

**HADEO**  
INSTRUMENTE GERMANY

Hohlmeißelzangen  
Bone Rongeurs  
Pinzas-gubias  
Pinze sgorbie



BEYER  
33201-18  
18 cm, 7"



MAYFIELD  
33202-18  
18 cm, 7"



ZAUFAL-JANSEN  
33205-18  
18 cm, 7"



— BÖHLER —  
33211-15 33213-15  
15 cm, 6"

**HADEO**  
INSTRUMENTE GERMANY

Hohlmeißelzangen  
Bone Rongeurs  
Pinzas-gubias  
Pinze sgorbie

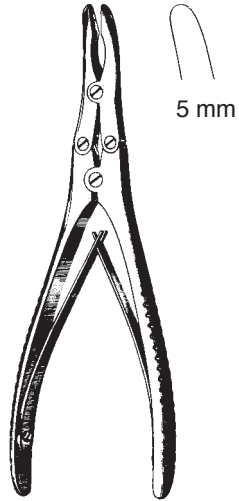

— RUSKIN —  
33216-18 33217-18  
18 cm, 7"

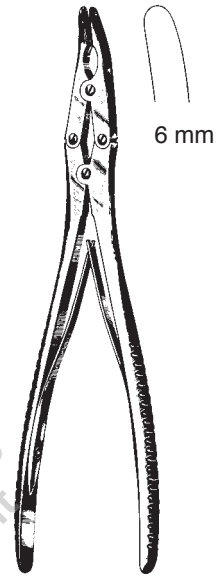

RUSKIN  
33219-23 23 cm, 9"



MARQUARDT  
33220-20 20 cm, 8"



**HADEO**  
INSTRUMENTE GERMANY

Hohlmeißelzangen  
Bone Rongeurs  
Pinzas-gubias  
Pinze sgorbie

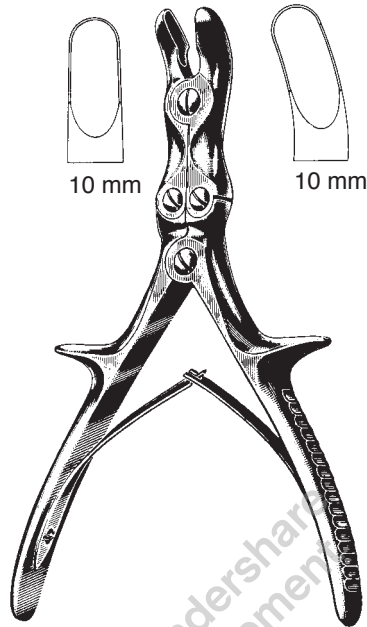

10 mm

10 mm

STILLE-LUER

33230-22	22 cm, 8 3/4"	33231-22
33230-26	26 cm, 10 1/4"	33231-26

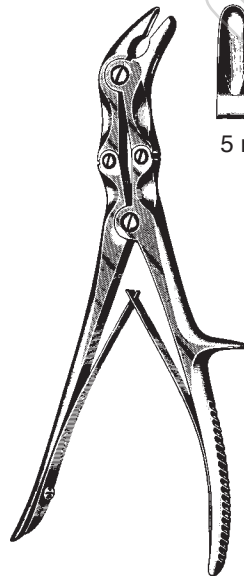

5 mm

STILLE-LUER  
33235-23  
23 cm, 9"

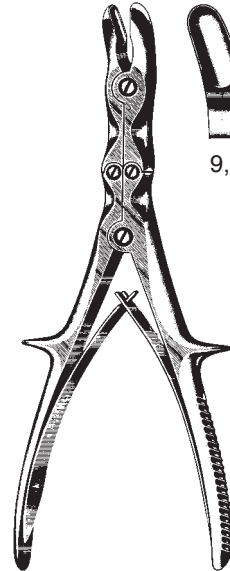

9,5 mm

STILLE-RUSKIN  
33237-23  
23 cm, 9"

**HADEO**  
INSTRUMENTE GERMANY

Hohlmeißelzangen  
Bone Rongeurs  
Pinzas-gubias  
Pinze sgorbie

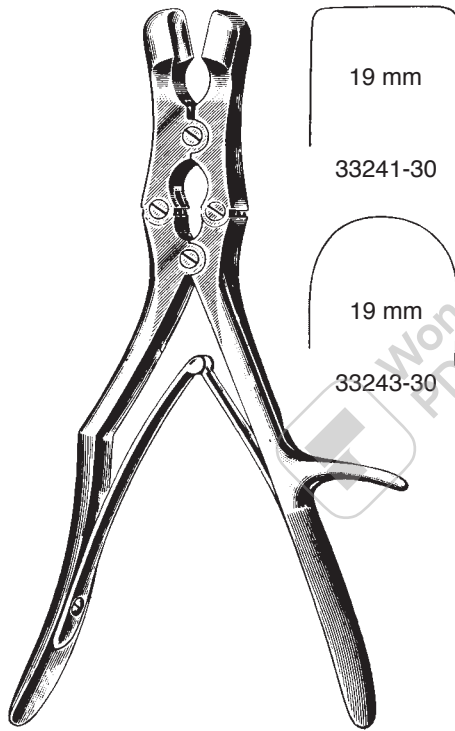

**SAUERBRUCH**  
30 cm, 10 3/4"



**LEKSELL (STILLE)**  
23 cm, 9"

**HADEO**  
INSTRUMENTE GERMANY

Hohlmeißelzangen  
Bone Rongeurs  
Pinzas-gubias  
Pinze sgorbie

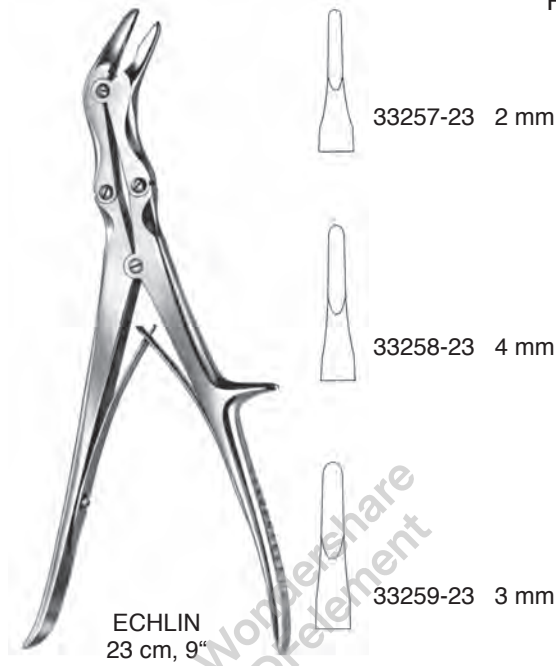

**HADEO**  
INSTRUMENTE GERMANY

Knochensplitterzangen  
Bone Cutting Forceps  
Pinzas cortantes para huesos  
Cesoie per ossa

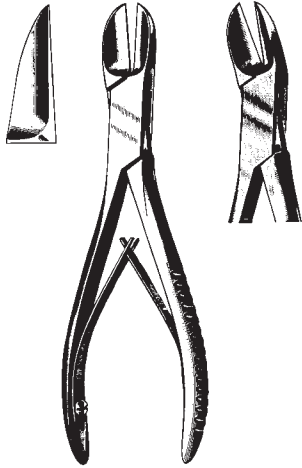

**LISTON**  
33274-14 14 cm, 5 1/2" 33275-14  
33274-17 17 cm, 6 3/4" 33275-17  
33274-19 19 cm, 7 1/2" 33275-19



**BÖHLER**  
33280-15 33281-15  
15 cm, 6"



**COTTLE-KAZANJIAN**  
33282-19  
19 cm, 7 1/2"



**MC INDOE**  
33283-17  
17 cm, 6 3/4"



**STAMM**  
33284-15  
15 cm, 6"



**RUSKIN-LISTON**  
33286-18 33289-18  
18 cm, 7"

**HADEO**  
INSTRUMENTE GERMANY

Knochensplitterzangen  
Bone Cutting Forceps  
Pinzas cortantes para huesos  
Cesoie per ossa



**STILLE-LISTON**  
33290-23 23 cm, 9" 33291-23  
33290-27 27 cm, 10 1/2" 33291-27



**STILLE-LISTON**  
33292-26  
26 cm, 10 1/4"



**STILLE-HORSLEY**  
33293-27  
27 cm, 10 1/2"



**SEMB**  
33295-24  
24 cm, 9 1/2"

**HADEO**  
INSTRUMENTE GERMANY

Anlegezangen, Klammerblock  
Applying Forceps, Clip Rack  
Pinzas aplicadoras, riel para grapas  
Pinza per applicare, porta-fermagli

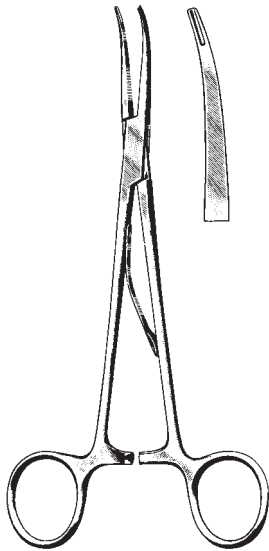

**McKENZIE**  
41011-15 15 cm, 6"  
41011-19 19 cm, 7 1/2"

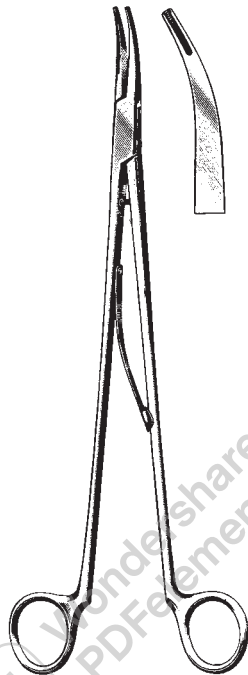

**SMITHWICK**  
41015-23 23 cm, 9"  
41015-26 26 cm, 10 1/4"

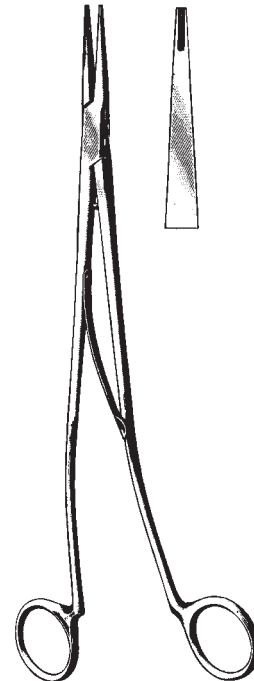

**SWEET**  
41017-23 23 cm, 9"  
41017-26 26 cm, 10 1/4"



**OLIVECRONA-TOENNIS**  
41019-14

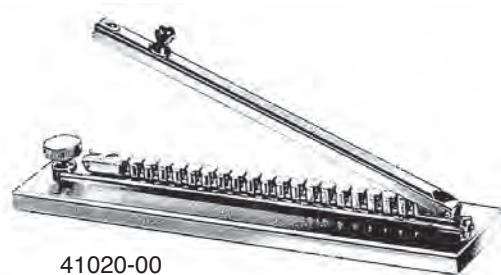

**41020-00**  
148 x 40 x 6 mm

SCHÄDELHALTER  
DRAHTSÄGEN  
TREPINEN

SKULL HOLDER  
WIRE SAWS  
TREPINE

CRÁNEO TITULAR  
ALAMBRE DE SIERRAS  
TREPANO

SKULL TITOLARE  
SEGHE A FILO  
TRAPANO

**HADEO**  
STRUMENTE GERMANY

[www.hadeo.co](http://www.hadeo.co)

**HADEO**  
INSTRUMENTE GERMANY

Schädelhalter, Kopfhautklammer, Anlegezange  
Cervical Traction Tongs, Clips, Applying Forceps  
Pinzas de tracción craneal, Clips, pinza aplicadora para clips  
Arco per trazione craniale, Pinza applicatrice

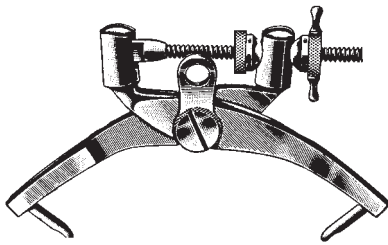

CRUTCHFIELD  
41025-01



CRUTCHFIELD  
41025-02



41026-35  
3,5 mm Ø



41026-50  
5 mm Ø

Stainless steel  
Acciaio inox  
acero inoxidable



RANEY  
41027-00

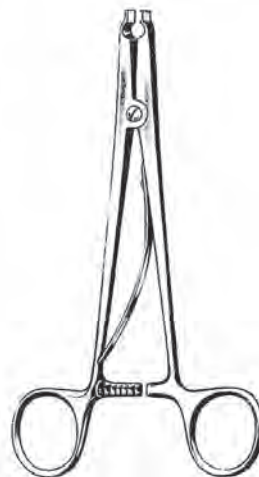

RANEY  
41028-00 16 cm, 6 1/4"



**HADEO**  
INSTRUMENTE GERMANY

Drahtsägen, Einführungsinstrument  
Wire Saws, Guiding Instruments  
Sierras de hilo de metal, Instrumentos para su introducción  
Seghe di filo d'acciaio, Strumenti introduttori



DeMARTEL  
41090-33  
33 cm, 13"

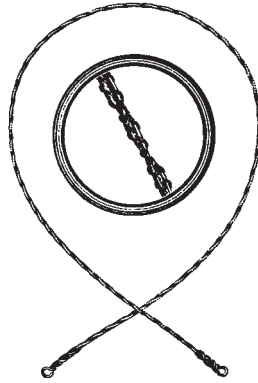

OLIVECRONA	cm	
41092-30	30,	11 3/4"
41092-40	40,	15 3/4"
41092-50	50,	19 3/4"
41092-60	60,	23 3/4"
41092-70	70,	27 1/2"



GIGLI STRULLY  
41093-00



GIGLI  
41094-00



HADEO  
41095-00

**HADEO**  
INSTRUMENTE GERMANY

Schädelzange  
Skull Punches  
Pinzas sacabocado craneal  
Pinza per craniotomia

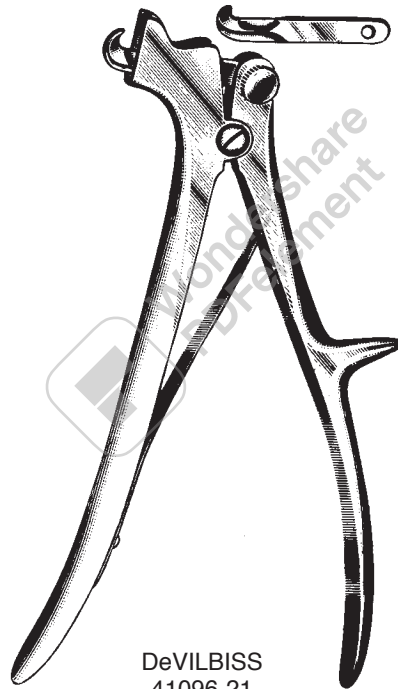

DeVILBISS  
41096-21  
21 cm, 8 1/4"

**HADEO**  
INSTRUMENTE GERMANY

Schädelstanze  
Cranial Punch  
Pinzas sacabocado craneal  
Pinza per craniotomia



CONE  
41097-22  
22,5 cm 9"

**HADEO**  
INSTRUMENTE GERMANY

Bohrloch-Schutzzange  
Bore hole protection Forceps  
Pinzas para la protección de orificio  
Pinze per la protezione del foro

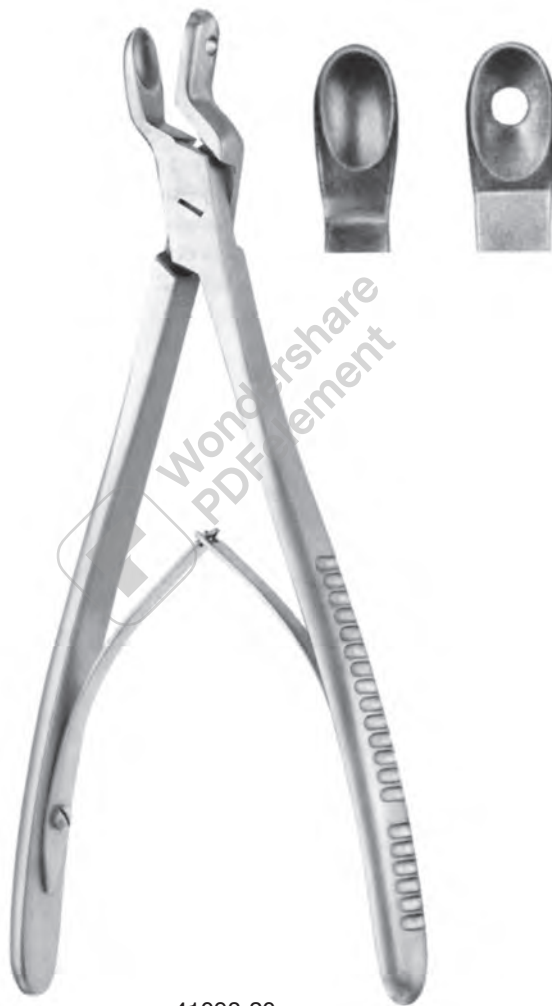

41098-20  
20,5 cm 8"

**HADEO**  
INSTRUMENTE GERMANYSchädeltrephine  
Skull Trephine  
Trépanos craneales  
Trapano cranicoSchädeltrephine mit verstellbarem Dorn  
und abnehmbarem Quergriff  
Skull trephines with adjustable centering point  
and detachable cross-bar handle  
Trépano craneal con guía-central ajustable  
y mango transversal desmontable  
Trapano cranico con punta regolabile  
e manico trasversale smontabile

GALT

34816-13 Ø 13 mm  
34816-16 Ø 16 mm  
34816-19 Ø 19 mm

Bohrlochzange

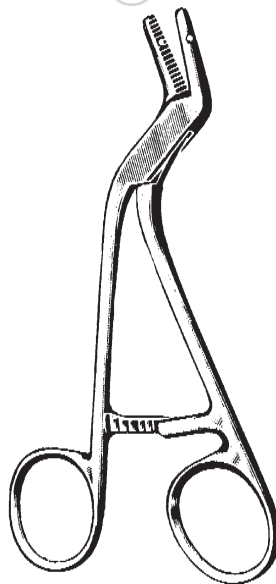
Drill Guide and Dura Protecting Forceps  
Pinza guía taladros y protectora de duramadre  
Pinze guida-perforatore e proteggi dura-madreADSON  
34231-15  
15 cm, 6"



Trephine  
Trephine  
Trepano  
Punta trapano

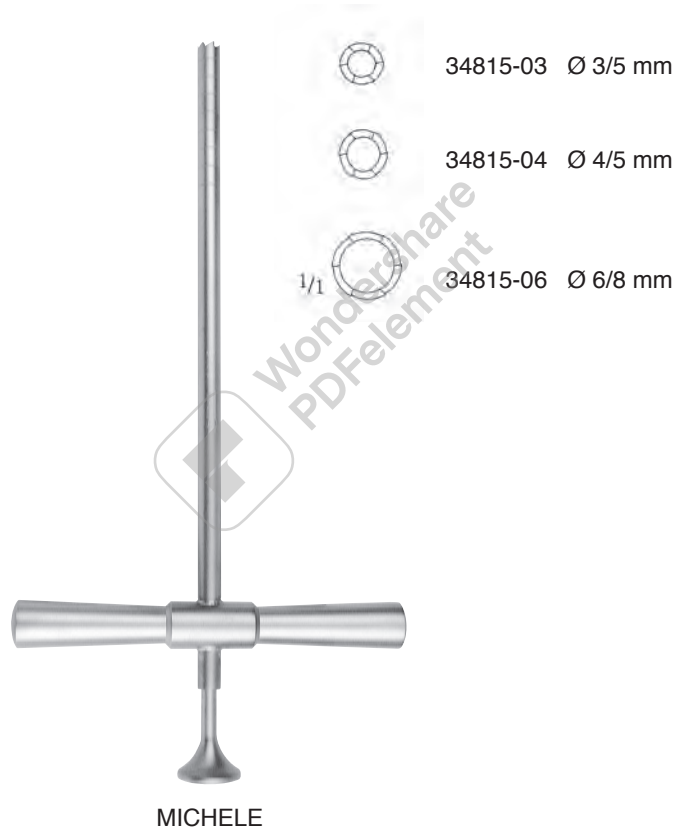

LÖFFEL, MEISSEL

CURETTES, CHISELS

CUCHARILLAS, CINCELES

CUCCHIAI, SCALPELLI

**HADEO**  
INSTRUMENTE GERMANY

[www.hadeo.co](http://www.hadeo.co)

**HADEO**  
INSTRUMENTE GERMANY

Scharfe Löffel  
Bone Currettes  
Cucharillas cortantes  
Curette taglienti

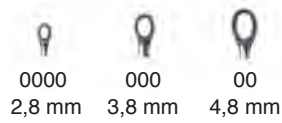

Fig.	
0000	33469-96
000	33469-97
00	33469-98
0	33470-00
1	33470-01
2	33470-02
3	33470-03
4	33470-04
5	33470-05
6	33470-06



**VOLKMANN**  
17 cm, 6 3/4"

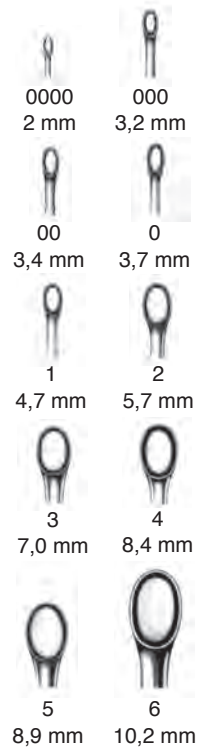

Fig.	
0000	33474-96
000	33474-97
00	33474-98
0	33475-00
1	33475-01
2	33475-02
3	33475-03
4	33475-04
5	33475-05
6	33475-06



**SPRATT**  
17 cm, 6 3/4"



**HADEO**  
INSTRUMENTE GERMANY

Scharfe Löffel  
Bone Currettes  
Cucharillas cortantes  
Curette taglienti



COBB  
27,9 cm 11"

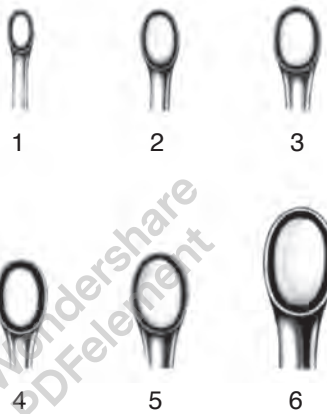
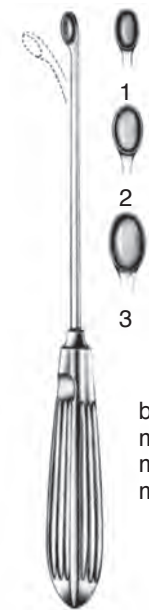

Fig.		
1	33473-01	3,5 mm
2	33473-02	4,5 mm
3	33473-03	5,5 mm
4	33473-04	7,5 mm
5	33473-05	8,5 mm
6	33473-06	10,0 mm

**HADEO**  
INSTRUMENTE GERMANY

Scharfe Löffel  
Bone Currettes  
Cucharillas cortantes  
Curette taglienti



- Fig.  
1 33476-01 4,8 mm  
2 33476-02 5,8 mm  
3 33476-03 6,8 mm

biegsam  
malleable  
maleable  
malleabile

HALLE  
21 cm, 8 1/4"



- Fig.  
000 33476-98 2,8 mm  
00 33476-99 3,3 mm  
0 33477-00 3,7 mm  
1 33477-01 4,3 mm  
2 33477-02 4,8 mm  
3 33477-03 5,6 mm  
4 33477-04 6,1 mm  
5 33477-05 6,7 mm  
6 33477-06 8,8 mm

SPINAL  
20 cm, 8"

**HADEO**  
INSTRUMENTE GERMANY

Scharfe Löffel  
Bone Currettes  
Cucharillas cortantes  
Curette taglianti

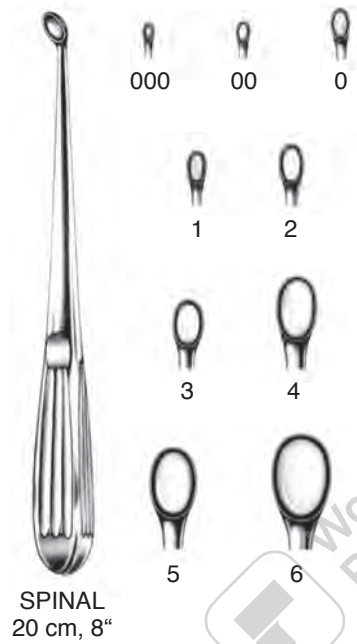

Fig.	Code	Tip Size
000	33478-98	2,8 mm
00	33478-99	3,3 mm
0	33479-00	3,7 mm
1	33479-01	4,3 mm
2	33479-02	4,8 mm
3	33479-03	5,6 mm
4	33479-04	6,1 mm
5	33479-05	6,7 mm
6	33479-06	8,8 mm



33482-01	4,7 mm
33482-02	4,7 mm
33482-03	4,7 mm

SCOVILLE  
25 cm, 10"

**HADEO**  
INSTRUMENTE GERMANY

Scharfe Löffel  
Bone Currettes  
Cucharillas cortantes  
Curette taglienti

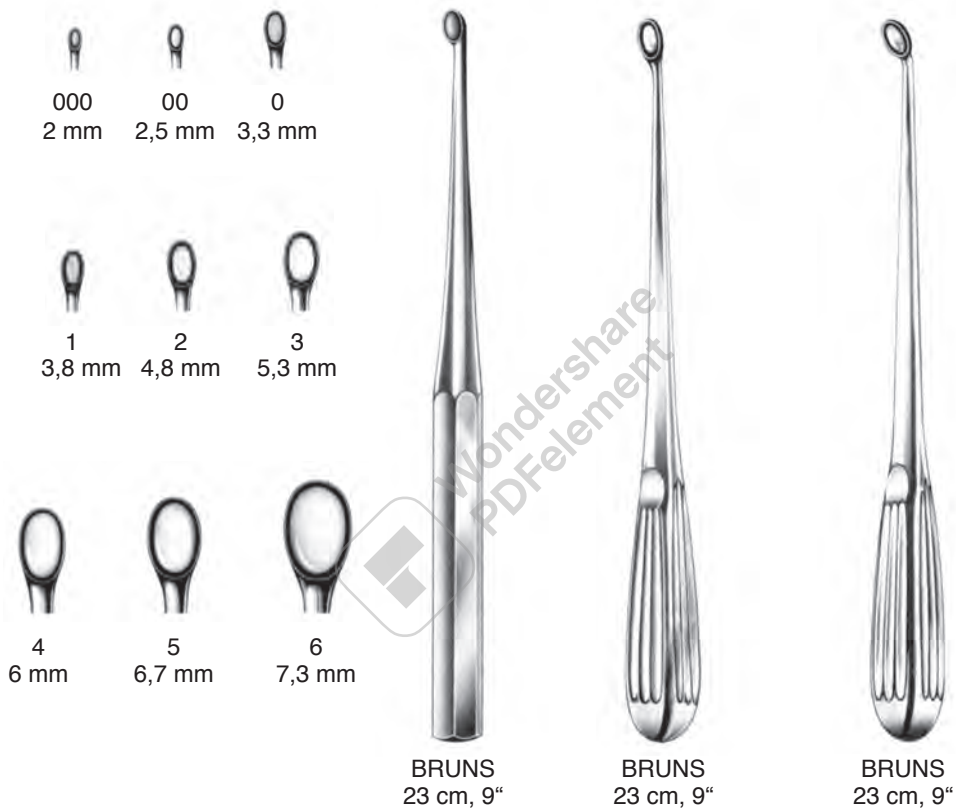

Fig.	33480-97	33482-97	2,8 mm	33484-97	2,8 mm
000	33480-98	33482-98	3,3 mm	33484-98	3,3 mm
0	33481-00	33483-00	3,7 mm	33485-00	3,7 mm
1	33481-01	33483-01	4,3 mm	33485-01	4,3 mm
2	33481-02	33483-02	4,8 mm	33485-02	4,8 mm
3	33481-03	33483-03	5,6 mm	33485-03	5,6 mm
4	33481-04	33483-04	6,1 mm	33485-04	6,1 mm
5	33481-05	33483-05	6,7 mm	33485-05	6,7 mm
6	33481-06	33483-06	8,8 mm	33485-06	8,8 mm

**HADEO**  
INSTRUMENTE GERMANY

Scharfe Löffel  
Bone Currettes  
Cucharillas cortantes  
Curette taglianti



DAUBENSPECK  
20 cm, 8"

Fig.	00	33487-99
	0	33488-00
	1	33488-01
	2	33488-02



27 cm, 10 1/2"

Fig.	0	33489-00
	1	33489-01
	2	33489-02
	3	33489-03



Scharfe Löffel  
 Bone Currettes  
 Cucharillas cortantes  
 Curette taglienti

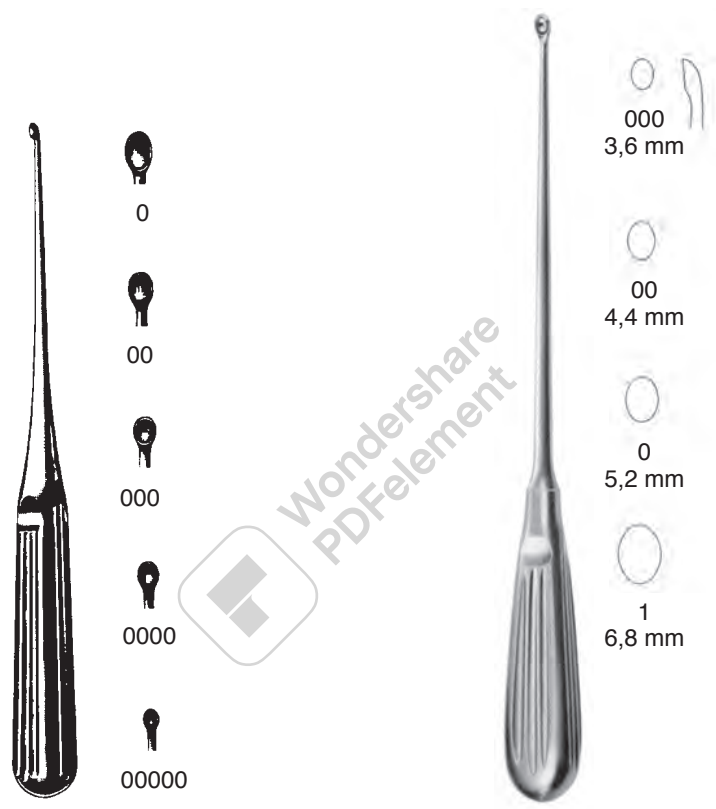

LEMPERT  
 17,5 cm, 7"

HADEO  
 25 cm, 10"

Fig. 0	33490-10	3,3 mm
00	33490-20	3,0 mm
000	33490-30	2,7 mm
0000	33490-40	2,4 mm
00000	33490-50	2,0 mm

Fig. 000	33491-01
00	33491-02
0	33491-03
1	33491-04



Scharfe Löffel  
Bone Currettes  
Cucharillas cortantes  
Curette taglienti

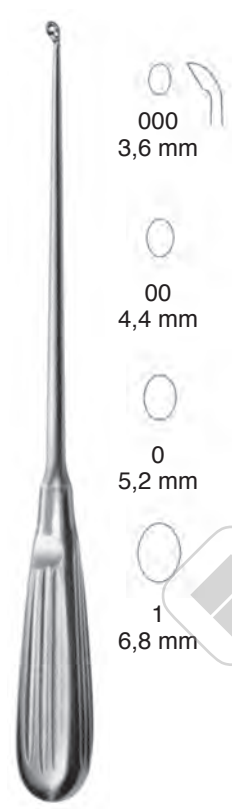

HADEO  
25 cm, 10"

- Fig. 000 33491-05
- 00 33491-06
- 0 33491-07
- 1 33491-08

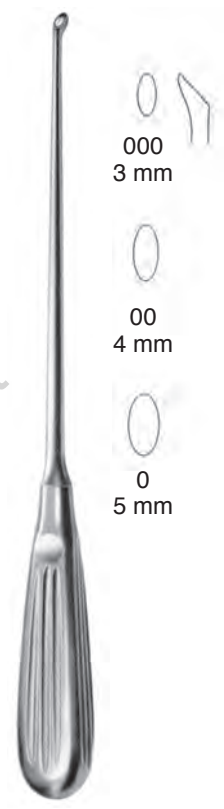

BUSHE  
25 cm, 10"

- Fig. 000 33500-01
- 00 33500-02
- 0 33500-03

**HADEO**  
INSTRUMENTE GERMANY

Scharfe Löffel  
Bone Currettes  
Cucharillas cortantes  
Curette taglienti

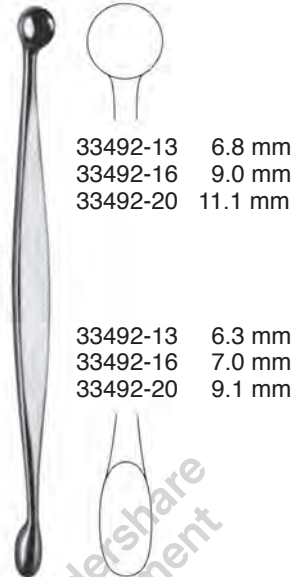

33492-13 6.8 mm  
33492-16 9.0 mm  
33492-20 11.1 mm

33492-13 6.3 mm  
33492-16 7.0 mm  
33492-20 9.1 mm

**VOLKMANN**

33492-13 13 cm, 5 1/8"  
33492-16 16 cm, 6 1/4"  
33492-20 20 cm, 8"



33494-13 6.4 mm  
33494-14 6.6 mm  
33494-17 6.8 mm

33494-13 6.3 mm  
33494-14 6.9 mm  
33494-17 7.3 mm

**VOLKMANN**

33494-13 13 cm, 5 1/8"  
33494-14 14 cm, 5 1/2"  
33494-17 17 cm, 6 3/4"



5.2 mm

3.5 mm

**JANSEN**

33495-16  
16 cm, 6 1/4"



**HADEO**  
INSTRUMENTE GERMANYMikro-Löffel  
Micro Scoops  
Micro-cucharillas  
Micro curette

93430-01 230 mm / 9"  
scharf  
sharp  
cortante  
tagliente

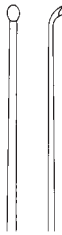

93430-02 230 mm / 9"  
scharf  
sharp  
cortante  
tagliente

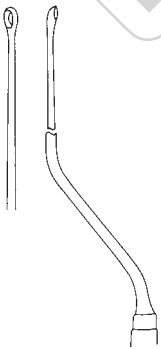

93430-03 185 mm / 7 1/4" YASARGIL  
scharf  
sharp  
cortante  
tagliente

**HADEO**  
INSTRUMENTE GERMANY

Knochenspanhalter und Einsetzinstrument  
Bone graft holder and impactor  
Injerto óseo titular y impactador  
Sostegno osseo e impattatore



CASPAR  
33508-22  
220 mm, 8 3/4"

**HADEO**  
INSTRUMENTE GERMANY

Stößel  
Hemostats  
Hemostáticos  
Pistoni



CASPAR  
200 mm, 8"

- 33509-03  
Ø 3 mm
- 33509-05  
Ø 5 mm
- 33509-08  
Ø 8 mm



200 mm, 8"

- 33510-12  
Ø 12 mm
- 33510-14  
Ø 14 mm
- 33510-16  
Ø 16 mm

**HADEO**  
INSTRUMENTE GERMANY

Flachmeißel, Osteotome, Hohlmeißel  
Chisels, Osteotomes, Gouges  
Cinceles, Osteotomos, Gubias  
Scalpelli, Osteotomi, sgorbie



STILLE  
20 cm, 8"

STILLE  
20 cm, 8"

6 mm	33630-06	
8 mm	33630-08	
10 mm	33630-10	33631-10
12 mm	33630-12	33631-12
15 mm	33630-15	33631-15
20 mm	33630-20	33631-20
25 mm	33630-25	33631-25
30 mm	33630-30	33631-30



STILLE  
20 cm, 8"

STILLE  
20 cm, 8"

STILLE  
20 cm, 8"

6 mm	33632-06	33633-06	33634-06
8 mm	33632-08	33633-08	33634-08
10 mm	33632-10	33633-10	33634-10
12 mm	33632-12	33633-12	33634-12
15 mm	33632-15	33633-15	33634-15
20 mm	33632-20	33633-20	33634-20
25 mm	33632-25	33633-25	33634-25
30 mm	33632-30	33633-30	33634-30

**HADEO**  
 INSTRUMENTE GERMANY

 Osteotome, Hohlmeißel  
 Osteotomes, Gouges  
 Osteotomos, Gubias  
 Osteotomi, sgorbie

 SMITH-PETERSEN  
 20 cm, 8"

6 mm	33644-06	33645-06	33647-06	
9 mm	33644-09	33645-09	33647-09	33649-09
13 mm	33644-13	33645-13		
14 mm			33647-14	33649-14
16 mm	33644-16	33645-16	33647-16	33649-16
19 mm	33644-19	33645-19	33647-19	33649-19
25 mm	33644-25	33645-25	33647-25	33649-25
32 mm	33644-32	33645-32	33647-32	33649-32



Osteotome  
 Osteotomes  
 Osteotomos  
 Osteotomi

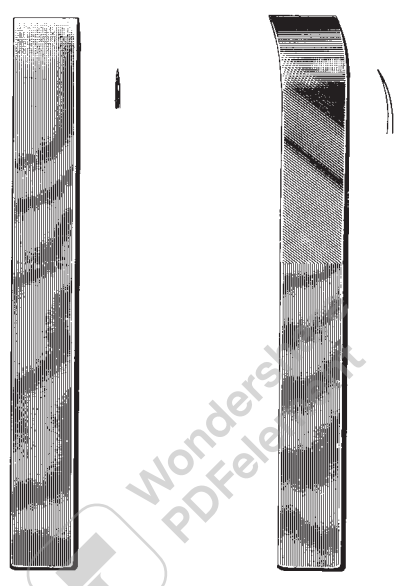

LAMBOTTE

24 cm, 9 1/2"		23 cm, 9"
33650-04	4 mm	33651-04
33650-06	6 mm	33651-06
33650-08	8 mm	33651-08
33650-10	10 mm	33651-10
33650-13	13 mm	33651-13
33650-16	16 mm	33651-16
33650-18	18 mm	33651-18
33650-20	20 mm	33651-20
33650-25	25 mm	33651-25
33650-30	30 mm	33651-30
33650-38	38 mm	33651-38
33650-44	44 mm	33651-44
33650-50	50 mm	33651-50

**HADEO**  
INSTRUMENTE GERMANY

Osteotome  
Osteotomes  
Osteotomos  
Mini Osteotomi

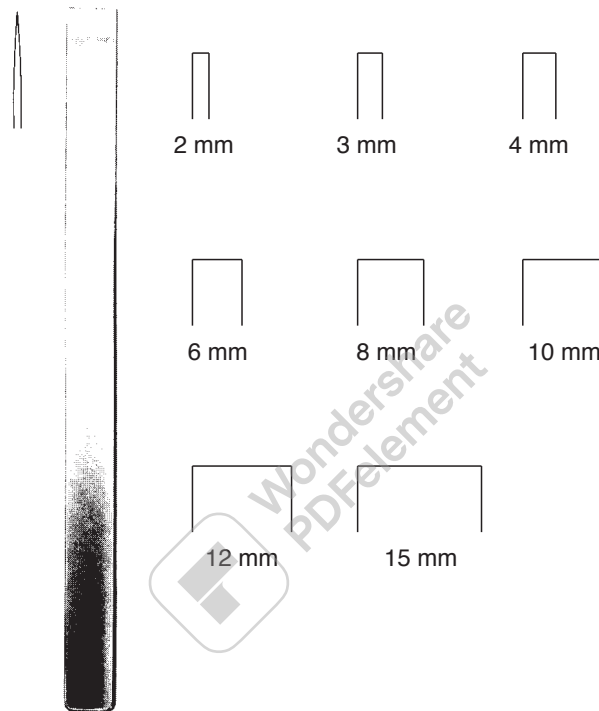

MINI-LAMBOTTE		
12,5 cm, 5"		17 cm, 6 3/4"
33654-02	2 mm	33652-02
33654-03	3 mm	33652-03
33654-04	4 mm	33652-04
33654-06	6 mm	33652-06
33654-08	8 mm	33652-08
33654-10	10 mm	33652-10
33654-12	12 mm	33652-12
33654-15	15 mm	33652-15



Hohlmeißel mit Ferrozellgriff  
Gouges with Ferrozell-Handle  
Gubias con mango de Ferrozell  
Sgorbie con manico di Ferrozell

8 mm



COBB  
28 cm, 11"  
33656-28

8 mm



COBB  
28 cm, 11"  
33657-28

8 mm



COBB  
28 cm, 11"  
33658-28

8 mm



COBB  
28 cm, 11"  
33659-28



**HADEO**  
INSTRUMENTE GERMANY

Osteotome, Hohlmeißel mit Ferrozell-Griff  
Osteotomes, Gouges with Ferrozell-Handle  
Osteotomos, Gubias con mango de Ferrozell  
Sgorbie, Osteotomo, con manico di Ferrozell



**LEXER**  
22 cm, 8 3/4"

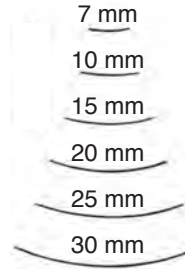
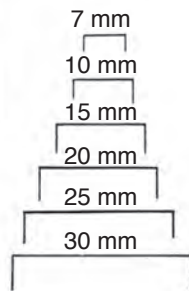

33660-07	7 mm	33661-07
33660-10	10 mm	33661-10
33660-15	15 mm	33661-15
33660-20	20 mm	33661-20
33660-25	25 mm	33661-25
33660-30	30 mm	33661-30



**LEXER**  
22 cm, 8 3/4"



**LEXER MINI**  
18 cm, 7"

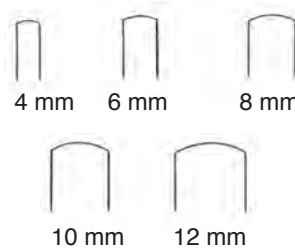
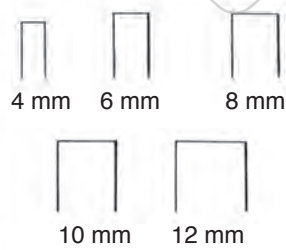

33664-04	4 mm	33665-04
33664-06	6 mm	33665-06
33664-08	8 mm	33665-08
33664-10	10 mm	33665-10
33664-12	12 mm	33665-12



**LEXER MINI**  
18 cm, 7"

**HADEO**  
INSTRUMENTE GERMANY

Flachmeißel, Hohlmeißel  
Chisels, Gouges  
Cinceles, Gubias  
Scalpelli, sgorbie



20 mm

33665-24  
24,5 cm, 9 3/4"



16 mm

33665-26  
26,5 cm, 10 1/2"



ZIELKE  
23 cm, 9"  
33665-55 5,5 mm  
33665-90 9,0 mm



9 mm

33666-22  
22 cm, 8 3/4"

**HADEO**  
INSTRUMENTE GERMANY

Meißel  
Gouges  
Gubias  
Sgorbie

Wirbelsäulenmeißel  
Lamina gouge  
Gubias para la columna vertebral  
Sgorbie per la colonna vertebrale



23,5 cm, 9 1/4"  
33667-06 6 mm  
33667-08 8 mm  
33667-11 11 mm  
33667-16 16 mm

Hohlmeißel mit NOVOTEX-Griff  
Gouges with NOVOTEX-Handle  
Gubias con mango de NOVOTEX  
Sgorbie con manico di NOVOTEX



25 cm, 10"  
33669-05 5 mm 33670-05  
33669-10 10 mm 33670-10  
33669-15 15 mm 33670-15



Septum Osteotom  
Rhinoplastic Osteotome  
Osteotomos para la plástica nasal  
Osteotomo per plastica nasale

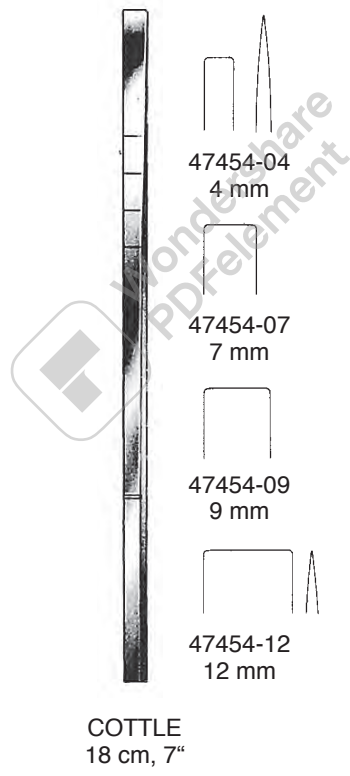

ELEVATORIEN  
RASPATORIEN  
DISSEKTOREN

ELEVATORS  
RASPATORIES  
DISSECTORS

ELEVADORES  
PERIOSTÓTOMOS  
DISECTORES

ELEVATORI  
PERIOSTOTOMI  
DISSETTORI

**HADEO**  
STRUMENTE GERMANY

[www.hadeo.co](http://www.hadeo.co)



**HADEO**  
INSTRUMENTE GERMANY

Elevatoren, Raspatorien, Dissektoren  
Elevators, Raspatories, Dissectors  
Elevadores, Periostótomos, Disectores  
Elevatori, Periostotomi, Dissettori

15 mm



JANSEN  
33701-16  
16,5 cm, 6 1/2"

12,5 mm



FARABEUF  
33702-15  
15 cm, 5.9"

12,5 mm



FARABEUF  
33703-15  
15 cm, 5.9"

11 mm



FARABEUF-COLLIN  
33704-01  
15,5 cm, 6"

**HADEO**  
INSTRUMENTE GERMANY

Elevatoren, Raspatorien, Dissektoren  
Elevators, Raspatories, Dissectors  
Elevadores, Periostótomos, Disectores  
Elevatori, Periostotomi, Dissettori

11 mm

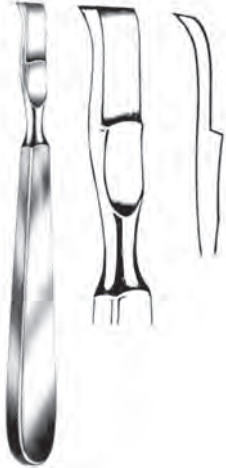

**FARABEU-FOLLIN**  
33704-02  
15,5 cm, 6"



**LAMBOTTE**  
21 cm, 8 1/4"  
33705-05 5 mm  
33705-10 10 mm  
33705-15 15 mm  
33705-20 20 mm  
33705-25 25 mm

18 mm



**SEDILLOT**  
33706-18  
18 cm, 7"

6 mm



**CUSHING  
(LITTLE-JOKER)**  
33707-15  
15 cm, 5.9"

**HADEO**  
INSTRUMENTE GERMANY

Elevatoren, Raspatorien, Dissektoren  
Elevators, Raspatories, Dissectors  
Elevadores, Periostótomos, Disectores  
Elevatori, Periostotomi, Dissettori

5 mm



SEBILLEAU  
33707-17  
17,5 cm, 7"

6 mm



QUERVAIN  
33708-19  
19,5 cm, 7 3/4"

15 mm

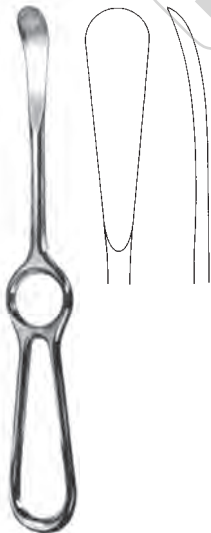

SEDILLOT  
33709-21  
21 cm, 8 1/4"

33710-01  
15 mm

33710-02  
16 mm



CUSHING  
18 cm, 7"





Elevatorien, Raspatorien, Dissektoren  
 Elevators, Raspatories, Dissectors  
 Elevadores, Periostótomos, Disectores  
 Elevatori, Periostotomi, Dissettori

halbscharf  
 semi-sharp  
 semi agudo  
 semiacuto



HOEN  
 18 cm, 7"

7 mm



33710-07

15 mm



33710-15

20 mm



33710-20

16 mm



LANGENBECK  
 33710-19  
 19 cm, 7 1/2"

14 mm



LANGENBECK  
 33711-18  
 18 cm, 7"



LANGENBECK  
 20 cm, 8"  
 33711-20 8 mm  
 33711-21 10 mm

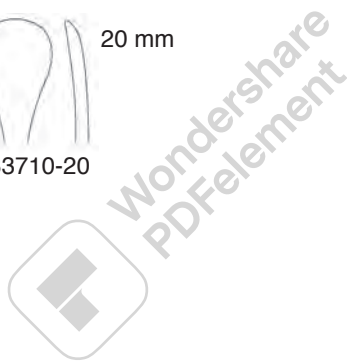

**HADEO**  
INSTRUMENTE GERMANY

Elevatoren, Raspatorien, Dissektoren  
Elevators, Raspatories, Dissectors  
Elevadores, Periostótomos, Disectores  
Elevatori, Periostotomi, Dissettori

4 mm



WILLIGER  
33711-16  
16 cm, 6 1/4"

6,5 mm



WILLIGER  
33712-16  
16 cm, 6 1/4"

5 mm



WILLIGER  
33713-16  
16 cm, 6 1/4"

5,5 mm



WILLIGER  
33713-17  
17 cm, 6 3/4"

5 mm



KÖNIG  
33714-15  
15,5 cm, 6"

12 mm

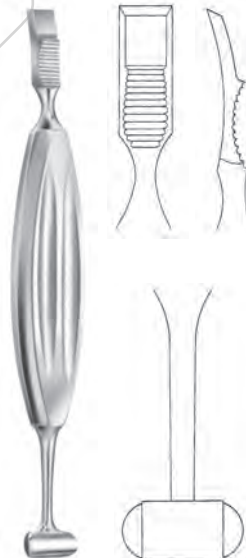

ALEXANDER  
33715-20  
21 cm, 8 1/4"



MOLT  
33716-18  
18 cm, 7"

**HADEO**  
INSTRUMENTE GERMANY

Elevatoren, Raspatorien, Dissektoren  
Elevators, Raspatories, Dissectors  
Elevadores, Periostótomos, Disectores  
Elevatori, Periostotomi, Dissettori

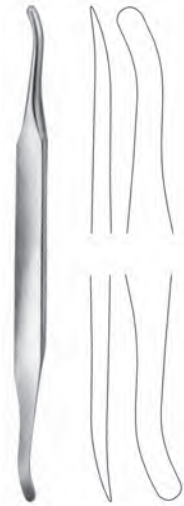

**SELDIN**  
33717-19-01  
19,5 cm, 7 3/4"

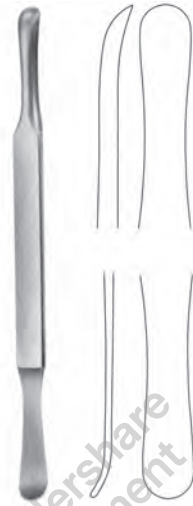

**SELDIN**  
33717-19-02  
19,5 cm, 7 3/4"

4 mm



**JOSEPH**  
33718-16  
16 cm, 6 1/4"



**FOMON**  
33719-17  
17 cm, 6 3/4"

9 mm



**BOIES**  
33720-19  
19 cm, 7 1/2"



**GORNEY**  
33720-21  
21 cm, 8 1/4"

**HADEO**  
INSTRUMENTE GERMANY

Elevatoren, Raspatorien, Dissektoren  
Elevators, Raspatories, Dissectors  
Elevadores, Periostótomos, Disectores  
Elevatori, Periostotomi, Dissettori

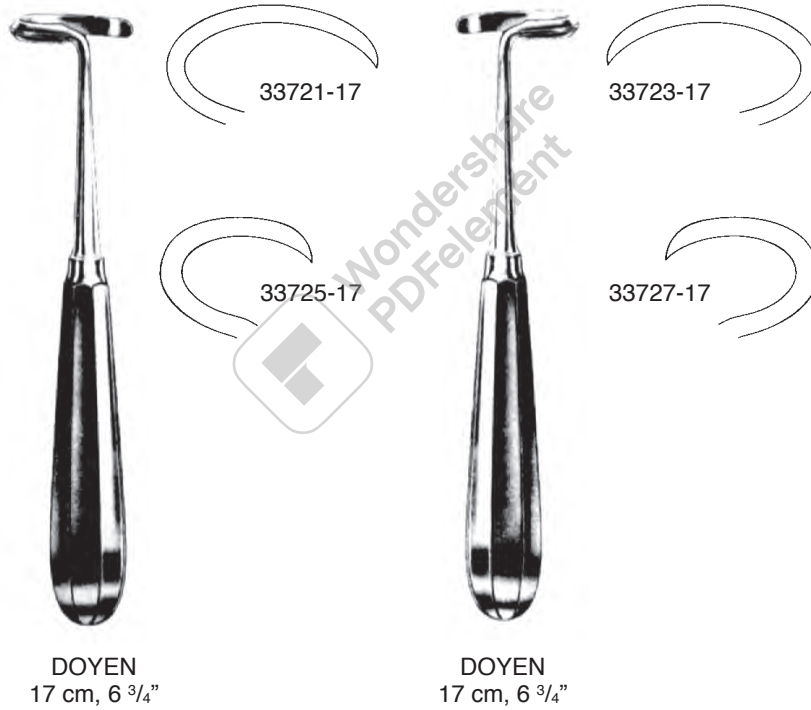

**HADEO**  
INSTRUMENTE GERMANY

Elevatoren, Raspatorien, Dissektoren  
Elevators, Raspatories, Dissectors  
Elevadores, Periostótomos, Disectores  
Elevatori, Periostotomi, Dissettori

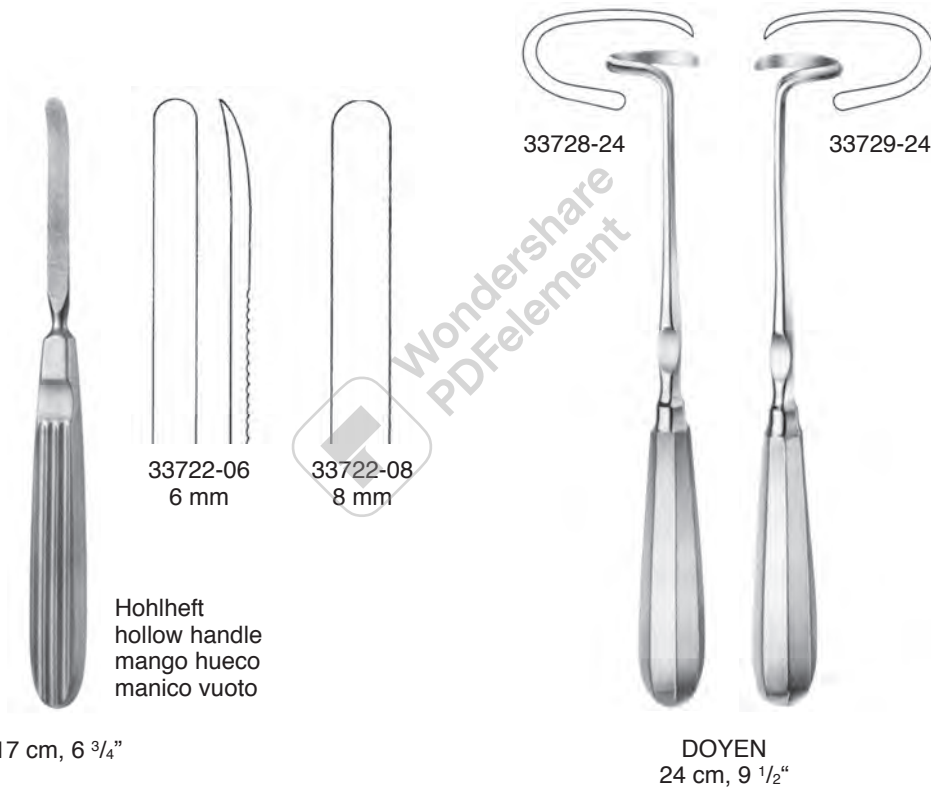

**HADEO**  
INSTRUMENTE GERMANY

Elevatoren, Raspatorien, Dissektoren  
Elevators, Raspatories, Dissectors  
Elevadores, Periostótomos, Disectores  
Elevatori, Periostotomi, Dissettori



**MATSON-ALEXANDER**  
33731-22  
22 cm, 8 3/4"



**MATSON**  
33733-22  
22 cm, 8 3/4"



Elevatoren, Raspatorien, Dissektoren  
 Elevators, Raspatories, Dissectors  
 Elevadores, Periostótomos, Disectores  
 Elevatori, Periostotomi, Dissettori



33740-19  
 19 cm, 7 1/2"



33741-18  
 18,5 cm, 7 1/4"



33742-18  
 18,5 cm, 7 1/4"



33743-18  
 18,5 cm, 7 1/4"

**HADEO**  
INSTRUMENTE GERMANY

Elevatoren, Raspatorien, Dissektoren  
Elevators, Raspatories, Dissectors  
Elevadores, Periostótomos, Disectores  
Elevatori, Periostotomi, Dissettori

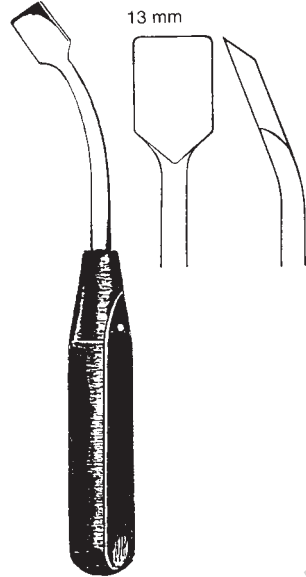

33745-19  
18,5 cm, 7 1/4"

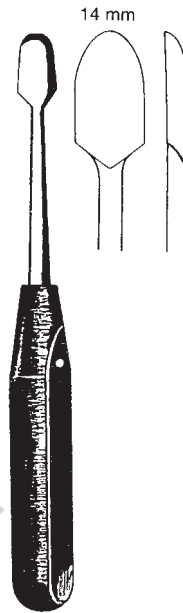

33746-19  
19,5 cm, 7 3/4"

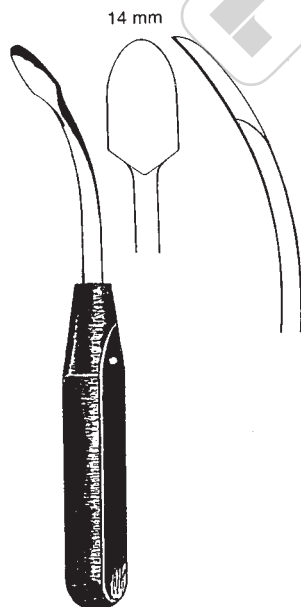

33747-18  
18,5 cm, 7 1/4"

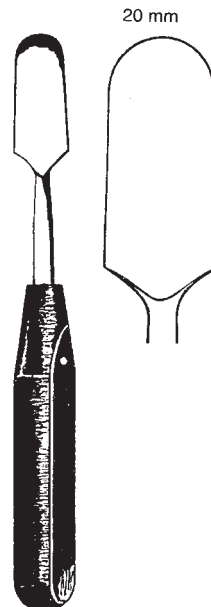

33748-20  
20 cm, 8"





Elevatorien, Raspatorien, Dissektoren  
 Elevators, Raspatories, Dissectors  
 Elevadores, Periostótomos, Disectores  
 Elevatori, Periostotomi, Dissettori

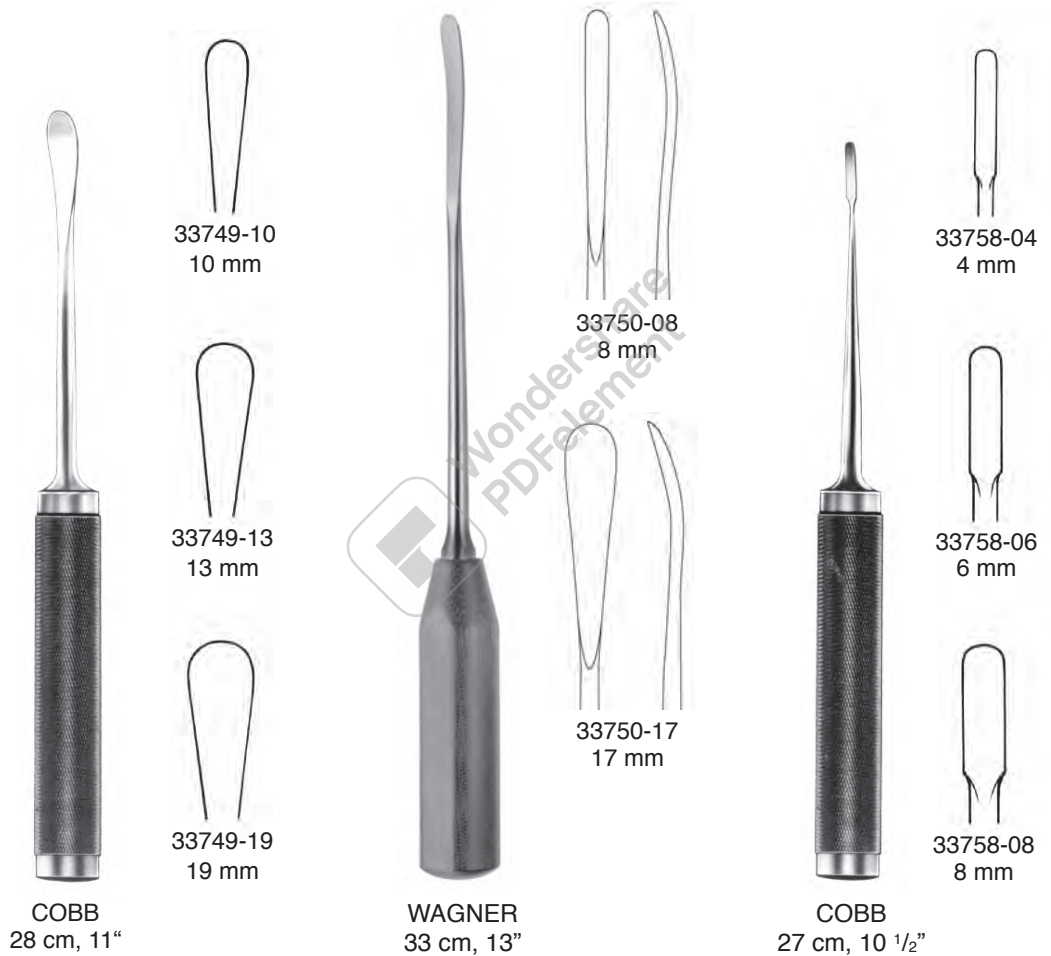

mit NOVOTEX-Kunststoffgriff  
 with NOVOTEX plastic handle  
 con mango de materia plástica NOVOTEX  
 con manico di materia plastica NOVOTEX



Elevatoren, Raspatorien, Dissektoren  
Elevators, Raspatories, Dissectors  
Elevadores, Periostótomos, Disectores  
Elevatori, Periostotomi, Dissettori

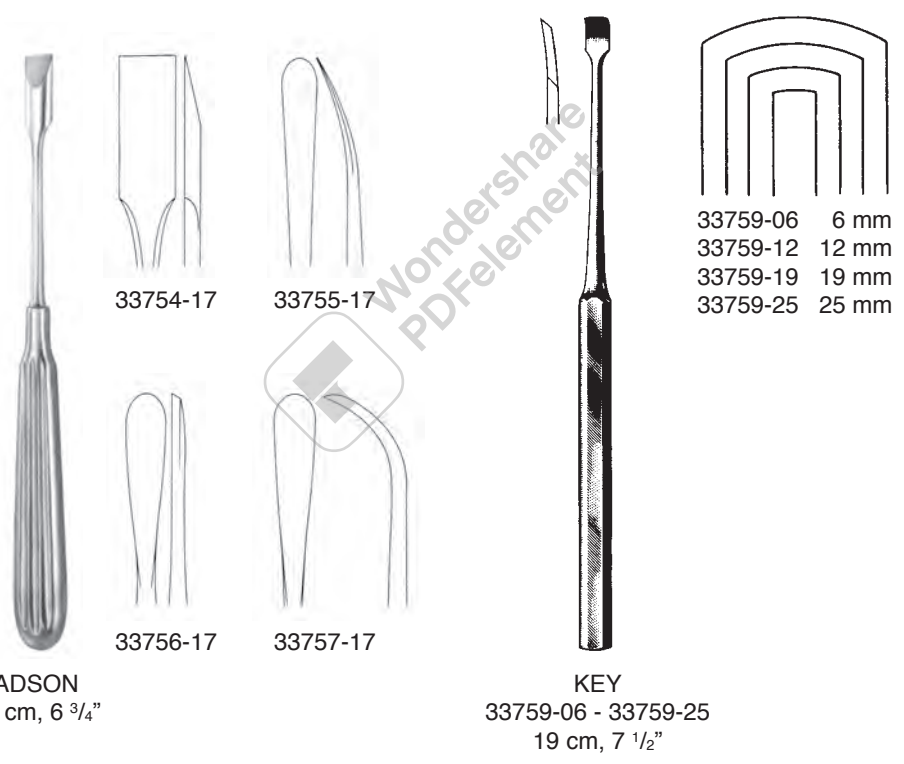



Elevatoren, Raspatorien, Dissektoren  
 Elevators, Raspatories, Dissectors  
 Elevadores, Periostótomos, Disectores  
 Elevatori, Periostotomi, Dissettori

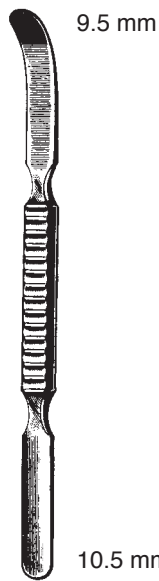

**WATSON-CHEYNE**  
 33765-17  
 17,5 cm, 7"



**MC DONALD**  
 33767-19  
 19 cm, 7 1/2"



**JOSEPH**  
 47411-16  
 16 cm, 6 1/4"



**SEWALL**  
 47412-20  
 20 cm, 8"

**HADEO**  
INSTRUMENTE GERMANY

Elevatoren, Raspatorien, Dissektoren  
Elevators, Raspatories, Dissectors  
Elevadores, Periostótomos, Disectores  
Elevatori, Periostotomi, Dissettori

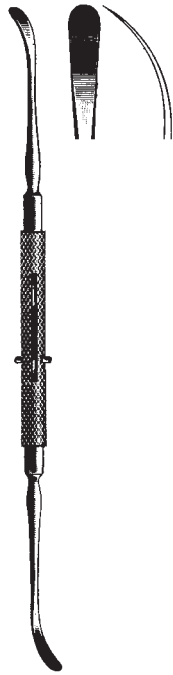

ROGER  
47413-19  
19 cm, 7 1/2"

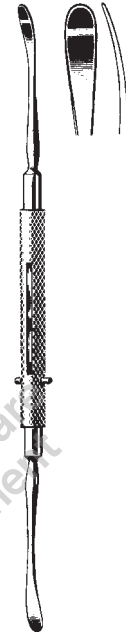

FREER  
47415-18  
18 cm, 7"

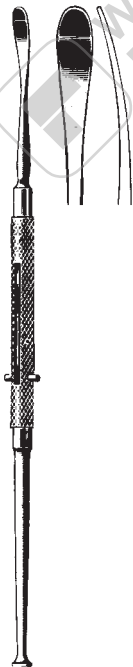

FREER  
47417-19  
19 cm, 7 1/2"

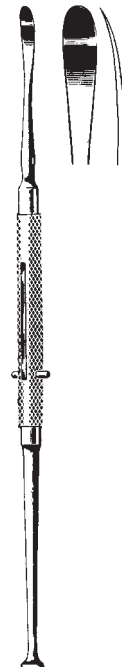

FREER  
47419-19  
19 cm, 7 1/2"

**HADEO**  
INSTRUMENTE GERMANY

Dura Dissektoren  
Dura Dissectors  
Disectores para duramadre  
Dissettori per dura-madre



SACHS  
41143-21  
21 cm, 8 1/4"

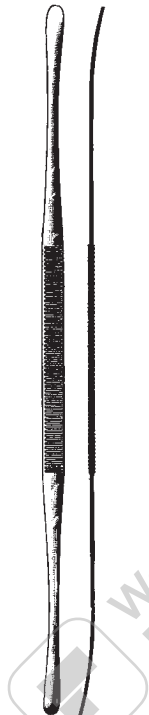

TOENNIS  
41141-25  
25 cm, 10"

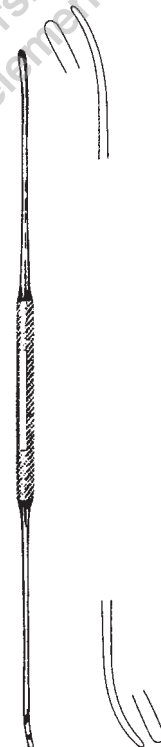

OLIVECRONA  
41146-18 18 cm, 7"  
41146-24 24 cm, 9 1/2"



DAVIS  
41142-19  
19 cm, 7 1/2"

**HADEO**  
INSTRUMENTE GERMANY

Dura Dissektoren  
Dura Dissectors  
Disectores para duramadre  
Dissettori per dura-madre

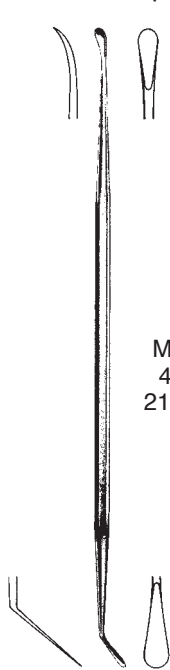

MILLIGAN  
41147-21  
21 cm, 8 1/4"

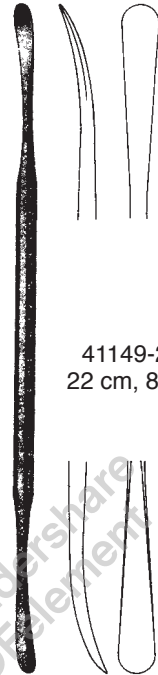

41149-22  
22 cm, 8 3/4"

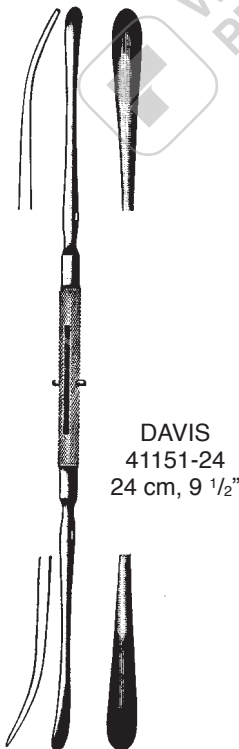

DAVIS  
41151-24  
24 cm, 9 1/2"

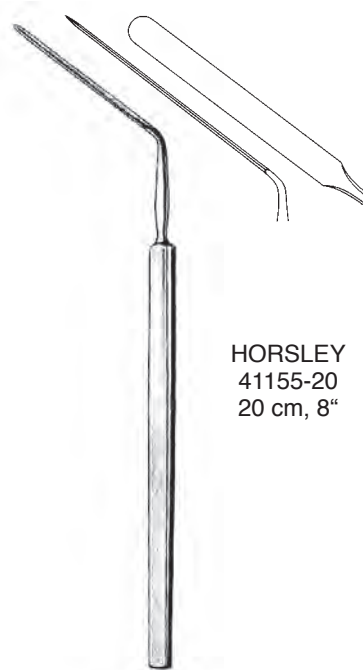

HORSLEY  
41155-20  
20 cm, 8"

**HADEO**  
INSTRUMENTE GERMANY

Dura Dissektoren  
Dura Dissectors  
Disectores para duramadre  
Dissettori per dura-madre



WOODSON  
41156-18  
18 cm, 7"

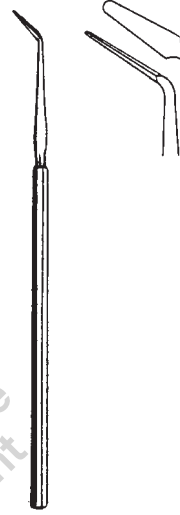

FRAZIER  
41158-01  
15 cm, 6"

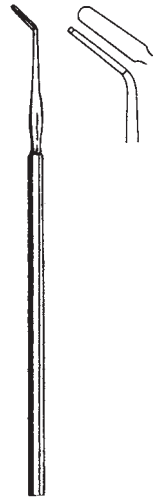

HOEN  
41158-02  
15 cm, 6"

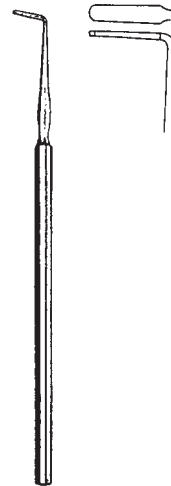

HOEN  
41158-03  
15 cm, 6"



Dissektoren, doppelendig  
Dissectors, double ended  
Disectores, de doble extremo  
Dissettori, doppio

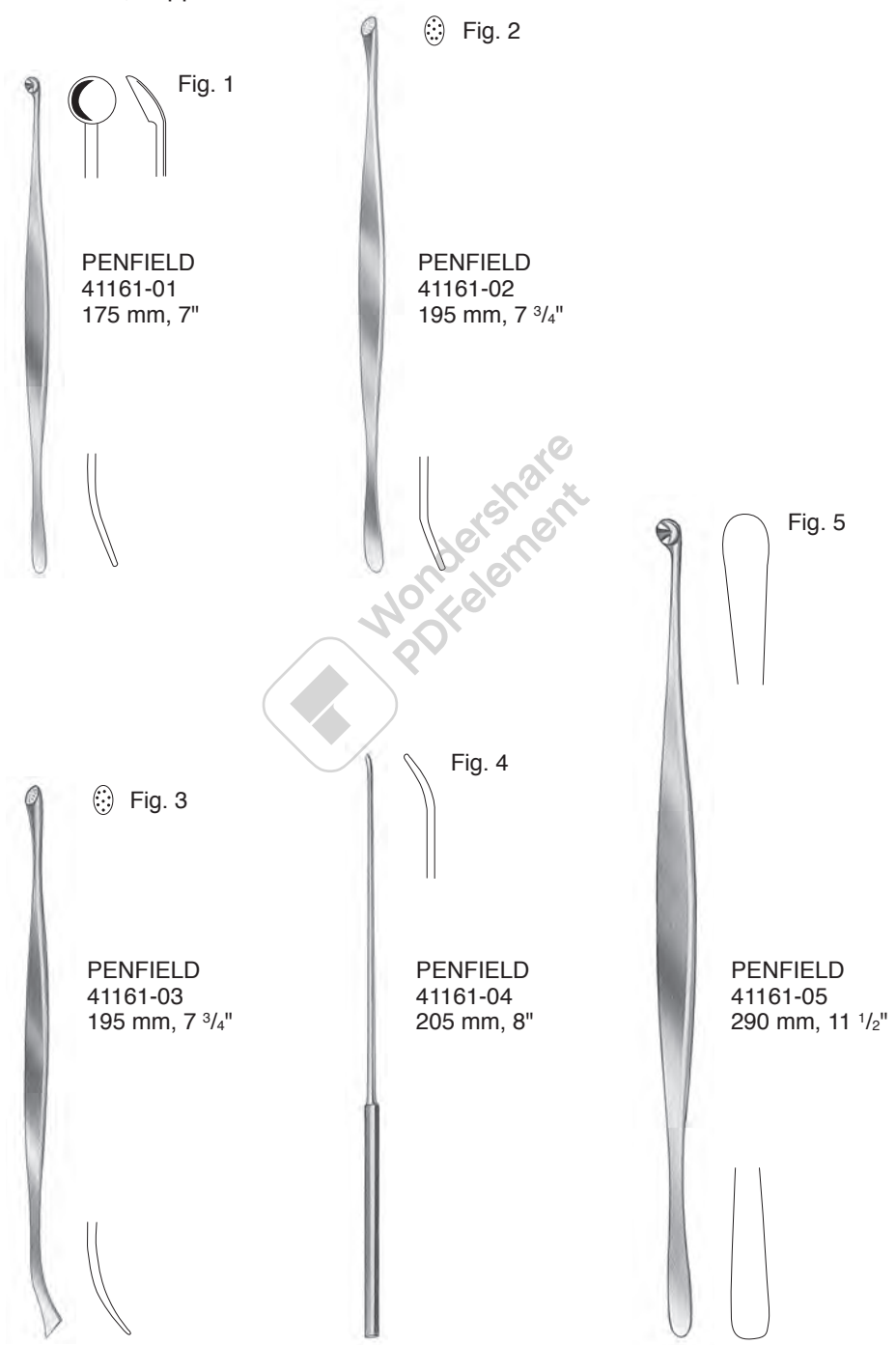



**HADEO**  
INSTRUMENTE GERMANY

Mikro-Raspatorien  
Micro-Raspatories  
Legras para micro-cirugía  
Micro periostotomi

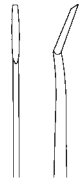

93410-01 185 mm / 7 1/4" YASARGIL

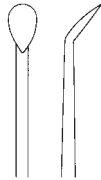

93410-02 185 mm / 7 1/4" YASARGIL



93410-03 185 mm / 7 1/4" YASARGIL



93410-05 185 mm / 7 1/4" YASARGIL



93410-06 230 mm / 9"  
plattenförmig  
round blade  
redondo  
rotondo piatto



93410-07 230 mm / 9"  
plattenförmig  
round blade  
redondo  
rotondo piatto



Mikro-Raspatorien  
Micro-Raspatories  
Legras para micro-cirugía  
Micro periostotomi

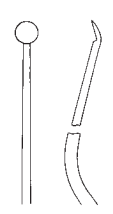

93420-01 230 mm / 9"

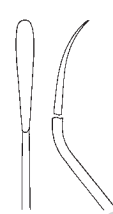

93420-02 185 mm / 7 1/4" YASARGIL

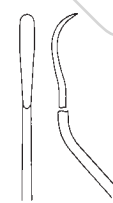

93420-03 185 mm / 7 1/4" YASARGIL

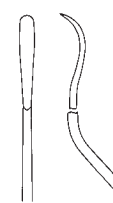

93420-04 185 mm / 7 1/4" YASARGIL

**HADEO**  
INSTRUMENTE GERMANY

Mikro-Dissektoren  
Micro Dissectors  
Micro dissectores  
Micro scollatori



4,5 mm



CASPAR  
93480-23  
230 mm / 9"

1,0 mm



CASPAR  
93481-20  
200 mm / 8"

1,4 mm



93482-23  
230 mm / 9"

2,0 mm



93483-23  
230 mm / 9"

1,8 mm



93484-23  
230 mm / 9"

3,0 mm



93485-18  
185 mm / 7 1/4"

3,0 mm



93486-21  
215 mm / 8 1/2"

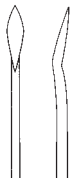

YASARGIL  
93487-18  
185 mm / 7 1/4"

**HADEO**  
INSTRUMENTE GERMANY

Mikro-Dissektoren  
Micro Dissectors  
Micro dissectores  
Micro scollatori

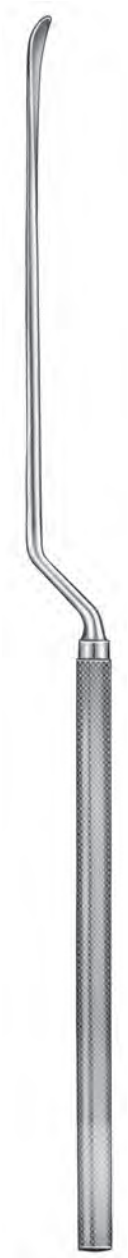

93490-01 230 mm / 9" CASPAR



93490-02 230 mm / 9" CASPAR



93490-03 210 mm / 8 1/4" CASPAR



93490-04 210 mm / 8 1/4" CASPAR



93490-05 230 mm / 9"



93490-06 230 mm / 9"

SAUGROHRE

SUCTION TUBES

TUBOS DE ASPIRACIÓN

TUBI D'ASPIRAZIONE

**HADEO**  
INSTRUMENTE GERMANY

[www.hadeo.co](http://www.hadeo.co)

**HADEO**  
INSTRUMENTE GERMANY

Saugrohre  
Suction Tubes  
Tubos de aspiración  
Tubi aspirazioni



ADSON  
41290-21  
21 cm, 8 1/4"  
ø 4 mm



FERGUSON  
41294-40  
18 cm, 7"  
ø 4 mm, 90°

isoliert  
insolated  
aislado  
isolato



Saugrohre, Punktionskanüle  
Suction Tubes, Puncture Cannulas  
Tubos de aspiración, Tubo de punción  
Tubi aspirazioni, cannula per punzione

Charr.	↗	
F.G. 30°		75°
6	41295-06	41297-06
7	41295-07	41297-07
8	41295-08	41297-08
9	41295-09	41297-09
10	41295-10	41297-10
11	41295-11	41297-11
12	41295-12	41297-12
15	41295-15	

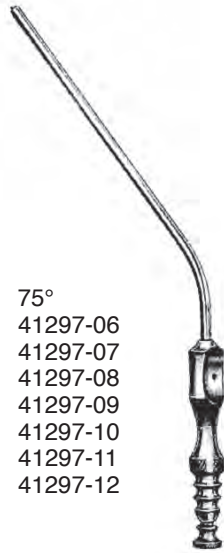

FRAZIER/FERGUSSON  
41295-06 – 41297-12  
19 cm, 7 1/2"



FRAZIER/FERGUSSON  
41298-12  
12 cm, 4 3/4" / 3 mm

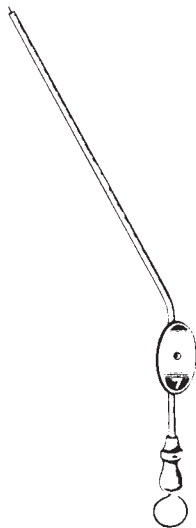

BARON  
16 cm, 6 1/4"  
41299-03 3FR 1,0 mm  
41299-05 5FR 1,6 mm  
41299-07 7FR 2,3 mm



SCHUHKNECHT  
13 cm, 5"  
41300-09 Ø 0,9 mm / 20 swg  
41300-06 Ø 0,6 mm / 24 swg

Saugadapter  
mit Saugunterbrecher  
Suction adapter  
with finger cut-off  
Adaptador para  
aspiración con interrupto  
Adattator per  
aspirazione con interruttore



HOUSE  
41300-00  
5,5 cm, 2 1/4"

**HADEO**  
INSTRUMENTE GERMANY

Saugrohre  
Suction Tubes  
Tubos de aspiración  
Tubi aspirazioni

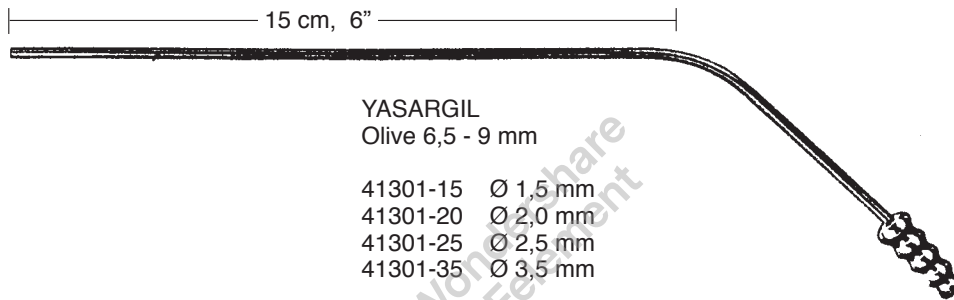
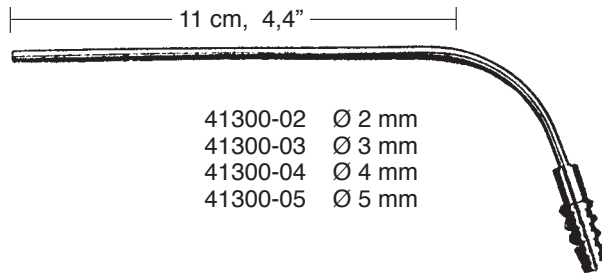

ZÖLLNER  
41302-01



ZÖLLNER  
41302-02



- |          |          |
|----------|----------|
| 0,5 mm Ø | 41306-05 |
| 0,7 mm Ø | 41306-07 |
| 0,9 mm Ø | 41306-09 |
| 1,2 mm Ø | 41306-12 |

Kanüle für Sauggriff  
für Zöllner und Wullstein

Tip for Suction Handle  
for Zöllner and Wullstein

Cánula para mango  
para Zöllner y Wullstein

Cannula per manico di aspirazione  
per Zöllner e Wullstein

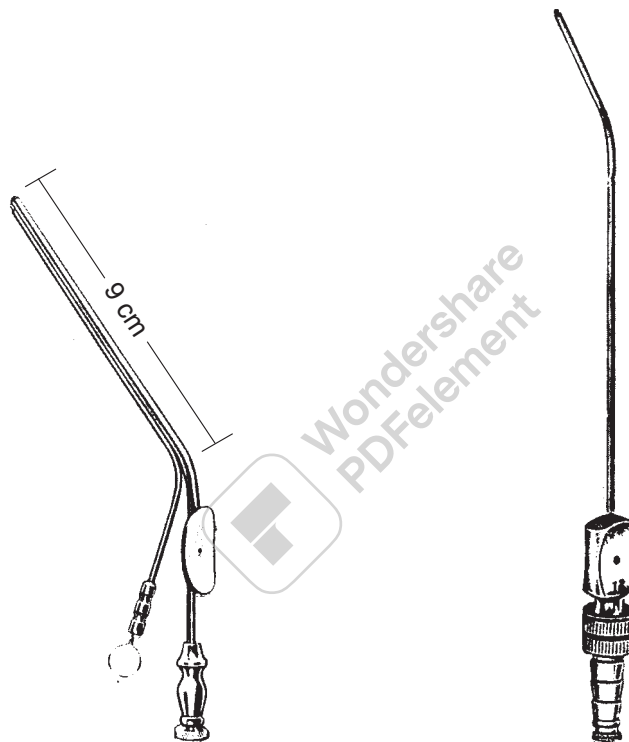

**HADEO**  
INSTRUMENTE GERMANYSaugrohre  
Suction Tubes  
Tubos de aspiración  
Tubi aspirazioni**HOUSE**

9 cm, 3 1/2"

41303-09	Ø 0,9 x 0,7 mm
41303-12	Ø 1,2 x 0,9 mm
41303-15	Ø 1,5 x 1,2 mm
41303-18	Ø 1,8 x 1,8 mm
41303-25	Ø 2,5 x 2,0 mm
41303-30	Ø 3,0 x 2,0 mm
41303-45	Ø 4,5 x 2,0 mm

**PLESTER 30°**

Charr. 6	41304-06
Charr. 8	41304-08
Charr. 10	41304-10

**HADEO**  
INSTRUMENTE GERMANY

Saugrohre  
Suction Tubes  
Tubos de aspiración  
Tubi aspirazioni

Mikro-Saugkanüle  
Micro suction cannula  
Micro tubo de aspiración  
Micro-cannula d'aspirazione

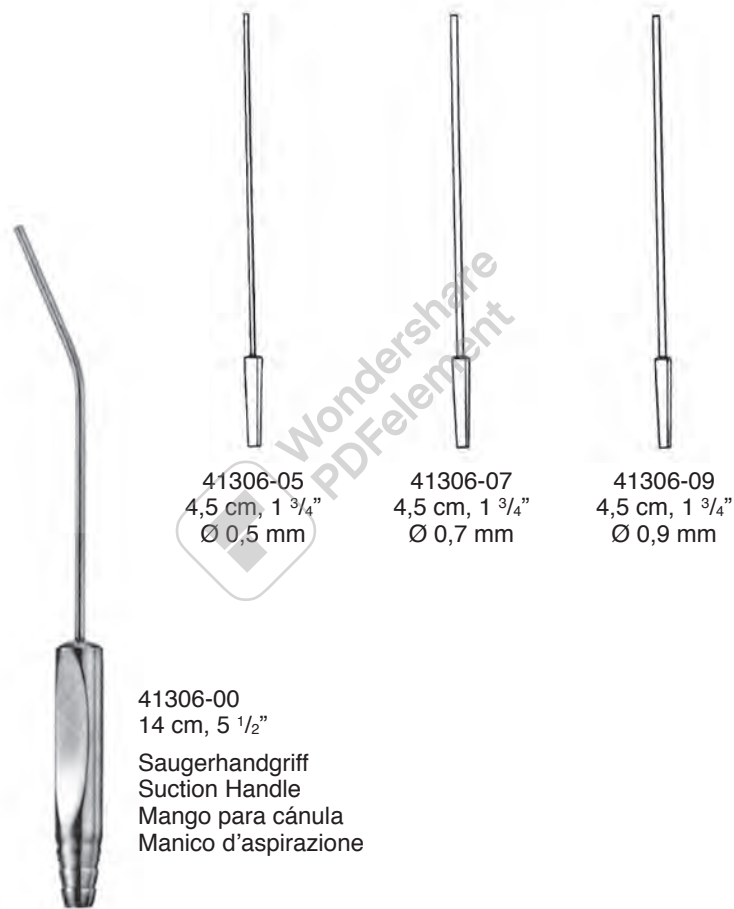

WULLSTEIN  
41308-00

komplett, mit Griff und drei Aufsätzen  
complete, with handle and 3 tips  
completo, con mango y 3 puntas  
completo, con manico e 3 punte

**HADEO**  
INSTRUMENTE GERMANY

Saugraspatorium  
Suction Raspatory  
Legra de succión  
Raspatorio con aspiratore

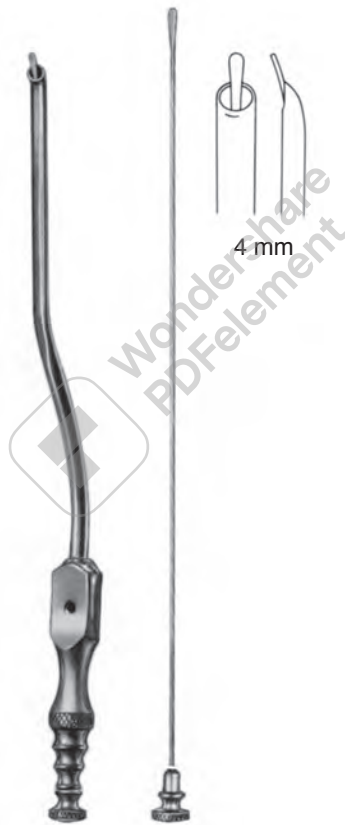

GUILLEN  
47347-20  
19 cm, 7 1/2"



LAMINEKTOMIE

LAMINECTOMY

LAMINECTOMIA

LAMINECTOMIA





[www.hadeo.co](http://www.hadeo.co)





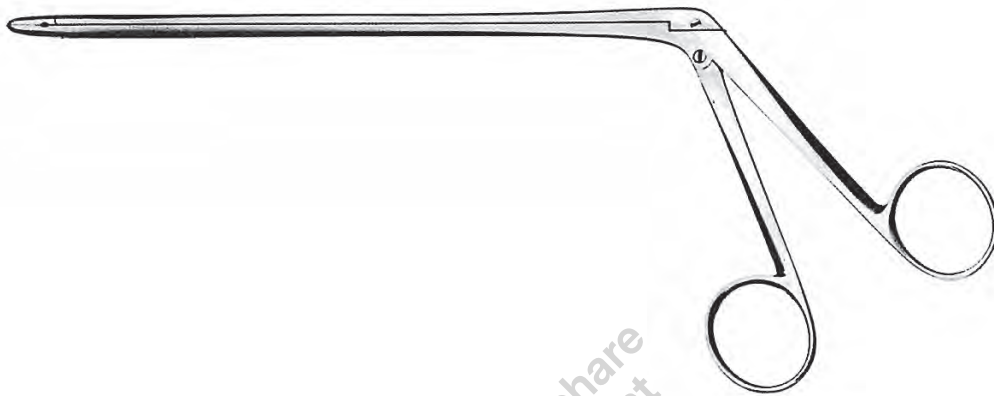

**HADEO**  
INSTRUMENTE GERMANY



Laminektomie Zangen  
Laminectomy Forceps  
Pinzas para laminectomia  
Pinze per laminectomia



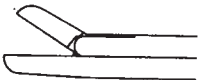

  
CUSHING  
2 x 10 mm

	41420-01	41420-02		45°		45°	
	41421-01	41421-02					125 mm / 5"
	41422-01	41422-02					150 mm / 6"
							180 mm / 7"

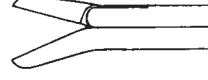
  
LOVE-GRUENWALD  
3 x 10 mm

	41430-01	41430-02		45°		45°	
	41431-01	41431-02					125 mm / 5"
	41432-01	41432-02					150 mm / 6"
							180 mm / 7"

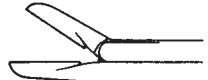
  
SPURLING  
4 x 10 mm

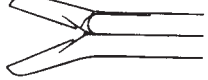
	41440-01	41440-02		45°		45°	
	41441-01	41441-02					125 mm / 5"
	41442-01	41442-02					150 mm / 6"
							180 mm / 7"

**HADEO**  
INSTRUMENTE GERMANY

Laminektomie Zangen  
Laminectomy Forceps  
Pinzas para laminectomia  
Pinze per laminectomia

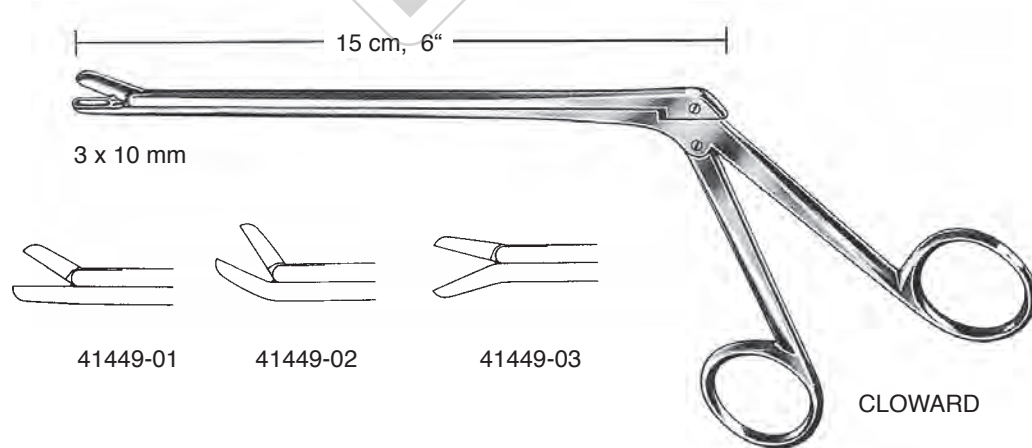
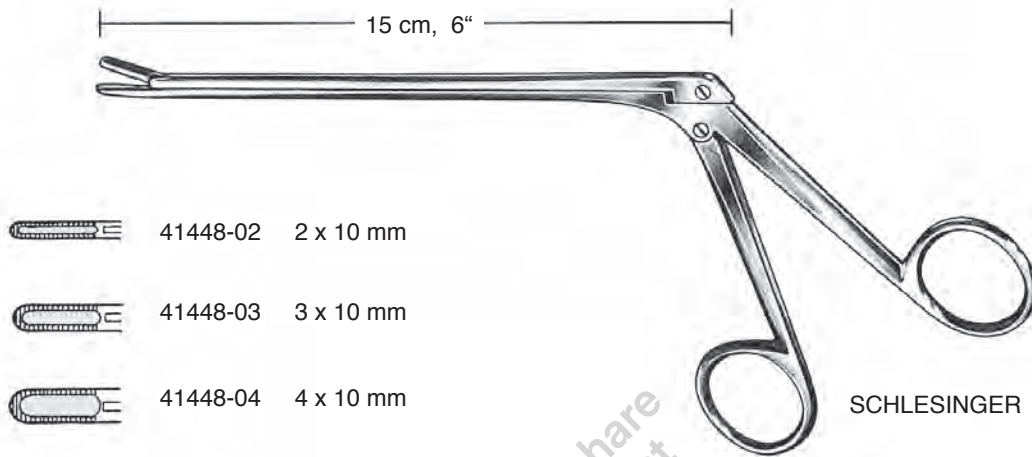



Laminektomie Zangen  
Laminectomy Forceps  
Pinzas para laminectomia  
Pinze per laminectomia



140 mm, 5 1/2"



HOEN  
41450-00



**HADEO**  
INSTRUMENTE GERMANY

Laminektomie Zangen  
Laminectomy Forceps  
Pinzas para laminectomia  
Pinze per laminectomia

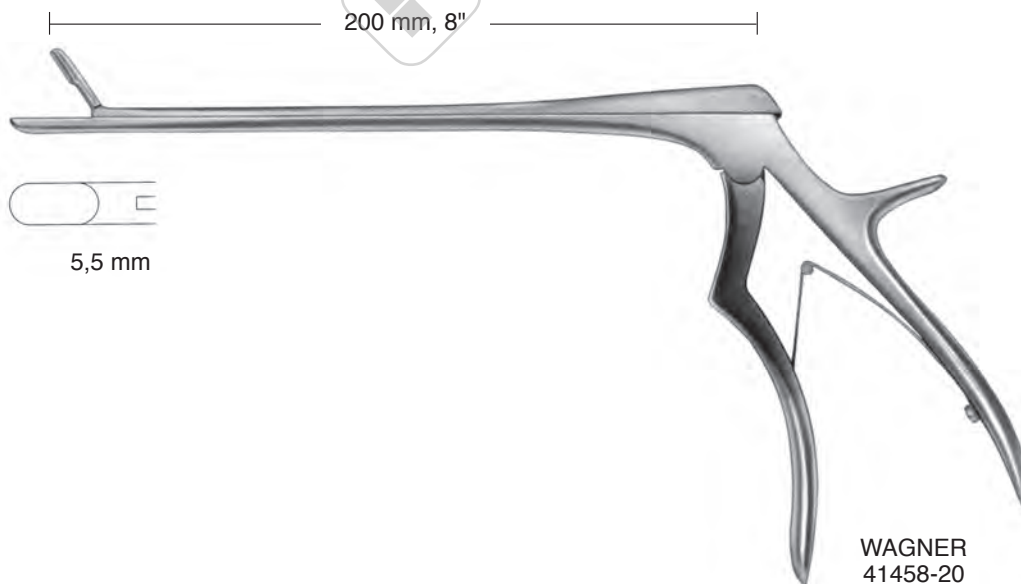
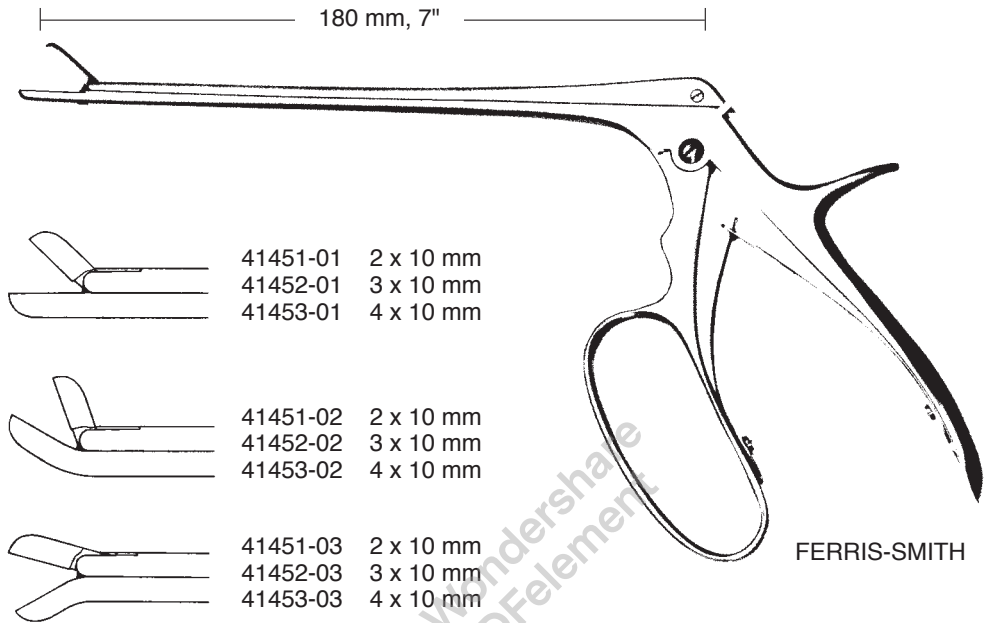



Laminektomie Zangen  
 Laminectomy Forceps  
 Pinzas para laminectomia  
 Pinze per laminectomia



Maulteile gezahnt  
 Serrated jaws  
 Parte de la boca dentada  
 Morsi dentellati

CASPAR



2 x 12 mm

41460-01  
 41461-01  
 41462-01

41460-02  
 41461-02  
 41462-02

41460-03  
 41461-03  
 41462-03

140 mm / 5 1/2"  
 160 mm / 6 1/4"  
 185 mm / 7 1/4"



3 x 12 mm

41465-01  
 41466-01  
 41467-01

41465-02  
 41466-02  
 41467-02

41465-03  
 41466-03  
 41467-03

140 mm / 5 1/2"  
 160 mm / 6 1/4"  
 185 mm / 7 1/4"

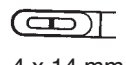

4 x 14 mm

41470-01  
 41471-01  
 41472-01

41470-02  
 41471-02  
 41472-02

41470-03  
 41471-03  
 41472-03

140 mm / 5 1/2"  
 160 mm / 6 1/4"  
 185 mm / 7 1/4"



5 x 14 mm

41475-01  
 41476-01  
 41477-01

41475-02  
 41476-02  
 41477-02

41475-03  
 41476-03  
 41477-03

140 mm / 5 1/2"  
 160 mm / 6 1/4"  
 185 mm / 7 1/4"



6 x 16 mm

41480-01  
 41481-01  
 41482-01

41480-02  
 41481-02  
 41482-02





41480-03  
 41481-03  
 41482-03

140 mm / 5 1/2"  
 160 mm / 6 1/4"  
 185 mm / 7 1/4"

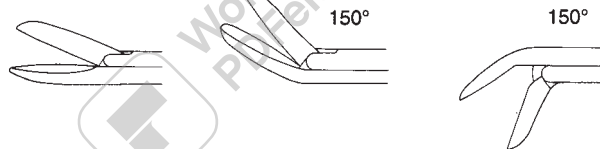
**HADEO**  
INSTRUMENTE GERMANY

Laminektomie Zangen  
Laminectomy Forceps  
Pinzas para laminectomia  
Pinze per laminectomia



 2 mm	41490-01	41490-02	41490-03
 3 mm	41492-01	41492-02	41492-03
 4 mm	41494-01	41494-02	41494-03
 5 mm	41496-01	41496-02	41496-03



Laminektomie Zangen  
 Laminectomy Forceps  
 Pinzas para laminectomia  
 Pinze per laminectomia

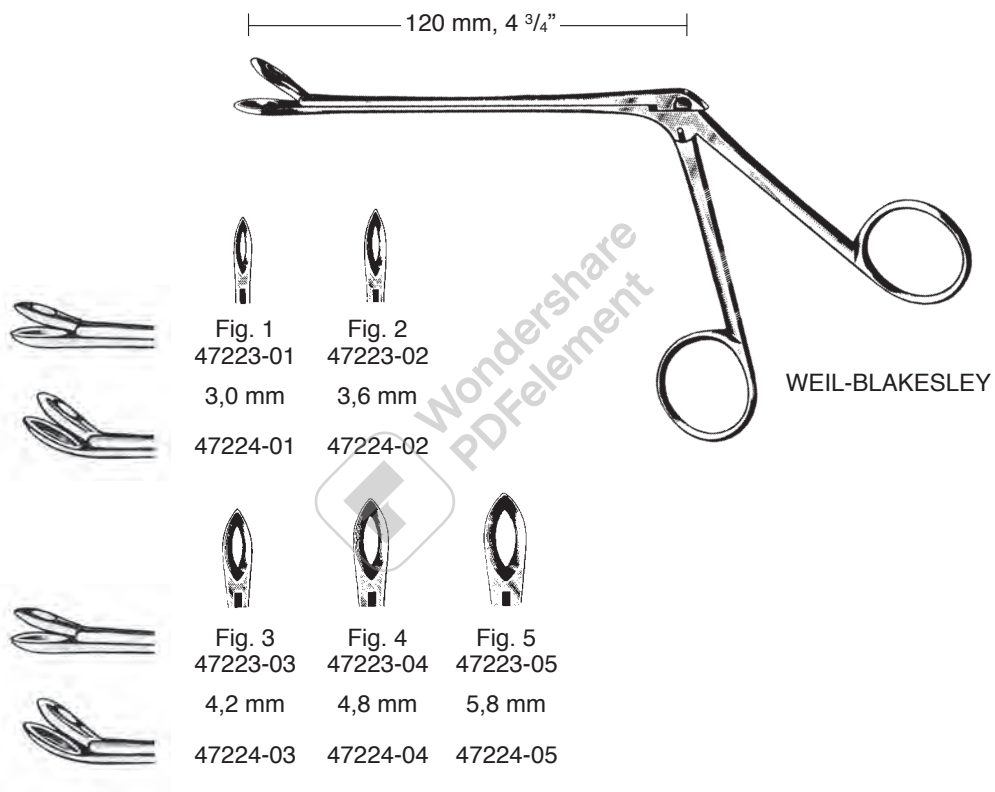

**HADEO**  
 INSTRUMENTE GERMANY

Hypophysen- und Tumorzangen  
 Pituitary Rongeurs and Tumor Grasping Forceps  
 Pinzas cortantes para hipófisis y para tumores  
 Pinze per ipofisi e tumori



41445-25 180 mm / 7" OLDBERG  
 Scharfe Hypophysenzange  
 Sharp Pituitary Rongeur  
 Pinza para hipófisis cortante  
 Pinze per ipofisi tagliente

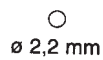

41446-02 190 mm / 7 1/2" LANDOLT  
 Scharfe Hypophysenzange  
 Sharp Pituitary Rongeur  
 Pinza para hipófisis cortante  
 Pinze per ipofisi tagliente

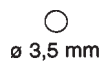

41446-03 190 mm / 7 1/2" YASARGIL  
 Scharfe Hypophysenzange  
 Sharp Pituitary Rongeur  
 Pinza para hipófisis cortante  
 Pinze per ipofisi tagliente



41446-09 200 mm / 8" LANDOLT  
 Tumor-Faßzange, stumpf  
 Tumor Grasping Forceps, blunt  
 Pinza para tumores, roma  
 Pinze per ipofisi smussa



MIKRO-RUNDGRIFF-  
INSTRUMENTE

MICRO INSTRUMENTS  
WITH ROUND HANDLE

INSTRUMENTOS PARA  
MICROCIRUGÍA CON  
MANGOS REDONDOS

STRUMENTI PER  
MICROCHIRURGIA CON  
MANICO ROTONDO

**HADEO**  
INSTRUMENTE GERMANY

[www.hadeo.co](http://www.hadeo.co)

Wondershare  
PDFelement



Mikro Gefäßmesser  
Micro Vessel Knives  
Micro cuchillos  
Micro coltelli per vasi

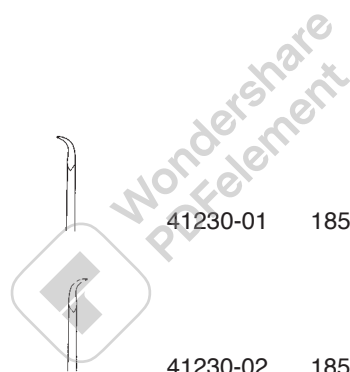

41230-01 185 mm / 7 1/4" KOOS



41230-02 185 mm / 7 1/4" KOOS



41230-03 185 mm / 7 1/4" KOOS

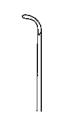

41230-05 185 mm / 7 1/4" YASARGIL



41230-06 185 mm / 7 1/4" YASARGIL



**HADEO**  
INSTRUMENTE GERMANY

Messer, Haken, Sonden  
Knives, Hooks, Probes  
Bisturies, Ganchos, Sondas  
Bisturi, Uncino, Sonde

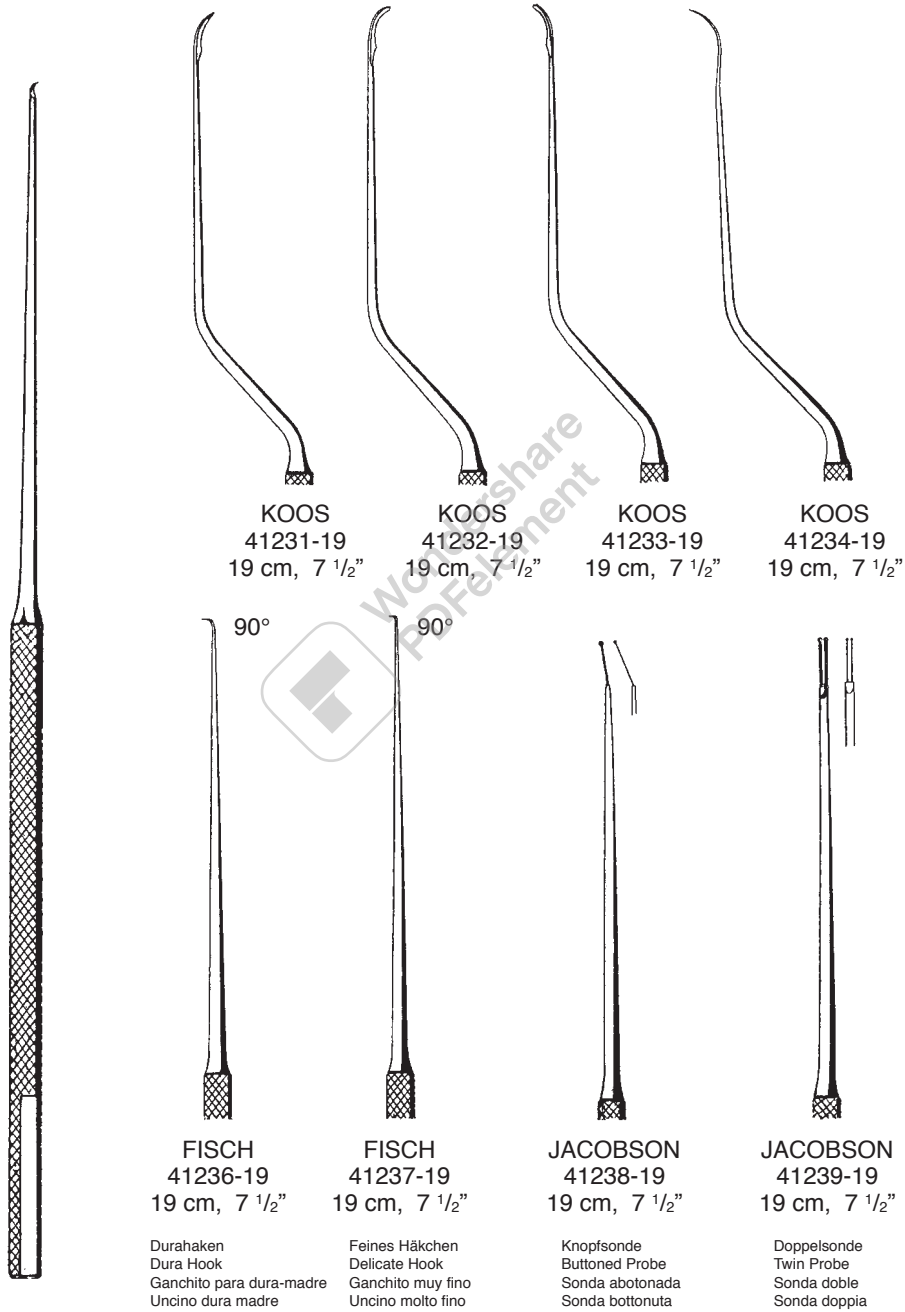

**HADEO**  
INSTRUMENTE GERMANY

Gefäßdilatoren, Gefäßspreizer  
Vessel dilators, Vessel Spreader  
Dilatadores vasculares, Separador para vasos  
Dilatatori vascolari, Divaricatore per vasi

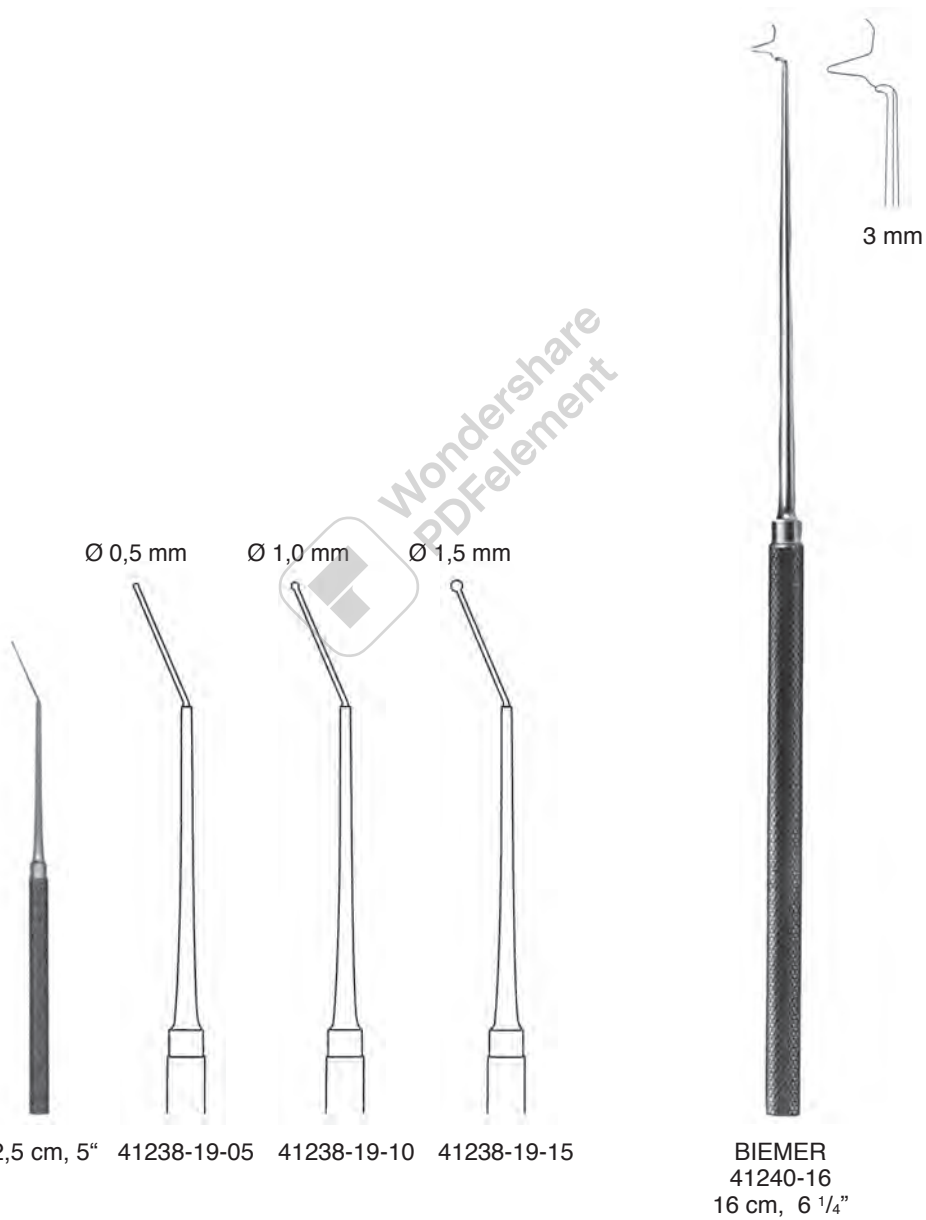



Tumormesser  
Knives for tumor tissue  
Cuchillos para tumores  
Coltelli per tumori



SAMII

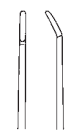

1,0 mm

93460-20 200 mm / 8"  
93460-23 230 mm / 9"



1,5 mm

93461-20 200 mm / 8"  
93461-23 230 mm / 9"



2,0 mm

93462-20 200 mm / 8"  
93462-23 230 mm / 9"

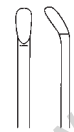

2,5 mm

93463-20 200 mm / 8"  
93463-23 230 mm / 9"



3,0 mm

93464-20 200 mm / 8"  
93464-23 230 mm / 9"



3,5 mm

93465-20 200 mm / 8"  
93465-23 230 mm / 9"



4,0 mm

93466-20 200 mm / 8"  
93466-23 230 mm / 9"



5,0 mm

93467-20 200 mm / 8"  
93467-23 230 mm / 9"



Tumormesser  
Knives for tumor tissue  
Cuchillos para tumores  
Coltelli per tumori



SAMII

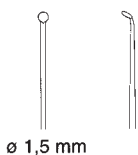

ø 1,5 mm

93470-20 200 mm / 8"  
93470-23 230 mm / 9"

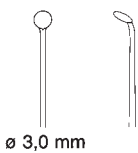

ø 3,0 mm

93471-20 200 mm / 8"  
93471-23 230 mm / 9"

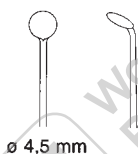

ø 4,5 mm

93472-20 200 mm / 8"  
93472-23 230 mm / 9"

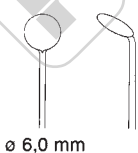

ø 6,0 mm

93473-20 200 mm / 8"  
93473-23 230 mm / 9"

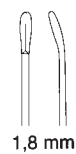

1,8 mm

93474-23 230 mm / 9"  
Lanzettenmesser  
Lancet knives  
Cuchillo lanceolar  
Coltelli lanceolari

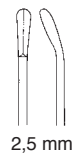

2,5 mm

93475-23 230 mm / 9"  
Lanzettenmesser  
Lancet knives  
Cuchillo lanceolar  
Coltelli lanceolari

**HADEO**  
INSTRUMENTE GERMANY

Fadengabel  
Suture Pusher  
Empujadores de suturas  
Sonda Conduitrice a forchetta



93500-18 185 mm / 7 1/4" JACOBSON

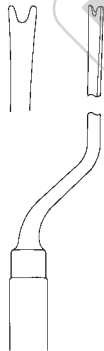

93501-23 230 mm / 9" CASPAR



Tumorgabeln  
Tumor Forks  
Horquillas para tumores  
Forchetta per tumori



3 mm

93505-01



4 mm

93505-02

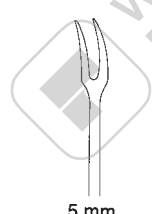

5 mm

93505-03

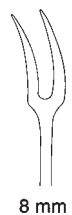

8 mm

93505-04

OKONEK-YASARGIL  
230 mm  
9"

**HADEO**  
INSTRUMENTE GERMANY

Gewebekralle  
Tissue Pick  
Garra para tejido  
Uncini per tessuti

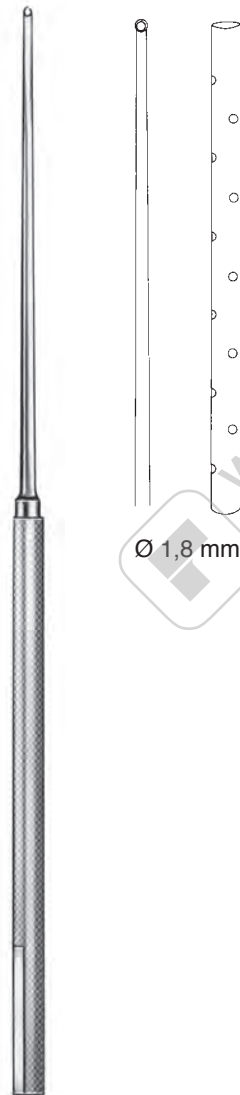

mit Schutzkappe  
with guard  
con protector  
con capuccio di protezione

Ø 1,8 mm

93510-18  
185 mm  
7 1/4"

**HADEO**  
INSTRUMENTE GERMANY

Mikro-Rundgriffinstrumente  
Micro Instruments with round Handle  
Instrumentos para microcirugía con mangos redondos  
Strumenti per Microchirurgia con manico rotondo

		41170-01 Ø 1 mm Raspatorium Raspatories Legra Periostotomi		41170-07 Ø 1,2 mm Dissektor Dissector Disector Dissettore		41170-11 2 mm 90° Häkchen, halbscharf Hook, semi-sharp Gancho, semi agudo Gancio, semiacuto
		41170-02 Ø 2 mm Raspatorium Raspatories Legra Periostotomi		41170-08 Ø 2,8 mm Dissektor Dissector Disector Dissettore		41170-12 2 mm 90° Häkchen, stumpf Hook, blunt Gancho, romo Gancio, smusso
		41170-03 Ø 3 mm Raspatorium Raspatories Legra Periostotomi		41170-04 Ø 1 mm Dissektor, spatelförmig Dissector, spatula Disector, espatulado Dissettore, spatulate		41170-13 3 mm 45° Häkchen, halbscharf Hook, semi-sharp Gancho, semi agudo Gancio, semiacuto
		41170-05 Ø 1,5 mm Dissektor, spatelförmig Dissector, spatula Disector, espatulado Dissettore, spatulate		41170-09 1 x 2 mm Scharfe Löffel, oval Curette, oval Cucharilla, oval Curette, ovale		41170-14 Nadel, halbscharf Needle, semi-sharp Aguja, semi agudo Ago, semiacuto
		41170-06 Ø 2 mm Dissektor, spatelförmig Dissector, spatula Disector, espatulado Dissettore, spatulate		41170-10 1 x 2 mm 45° Scharfe Löffel, oval Curette, oval Cucharilla, oval Curette, ovale		41170-15 90° Knopfsonde Buttoned probes Sonda abotonada Sonda bottonute

RHOTON  
19 cm, 7 1/2"





Tumorgabel  
Tumor fork  
Horquilla para tumores  
Forchette per tumori



93506-05  
5 mm

93506-08  
8 mm

YASARGIL  
20 cm, 8"





HYPOPHYSEKTOMIE

HYPOPHYSECTOMY

HIPOFISECTOMÍA

IPOFISECTOMIA



[www.hadeo.co](http://www.hadeo.co)



Ringküretten  
Ring Curettes  
Curetas anulares  
Curette anulari



CONE  
23 cm 9"

33751-01  
33751-02  
33751-03

Ø 3 mm  
Ø 6 mm  
Ø 8 mm

33753-01  
33753-02  
33753-03

**HADEO**  
INSTRUMENTE GERMANY

Hypophyse Pinzetten  
Hypophyseal Forceps  
Pinzas para hipófisis  
Pinze per ipofisi



ADSON  
41210-23  
23 cm, 9"



ADSON  
41211-23  
23 cm, 9"



ADSON  
41213-23  
23 cm, 9"

**HADEO**  
INSTRUMENTE GERMANY

Küretten  
Curette  
Curetas  
Curette

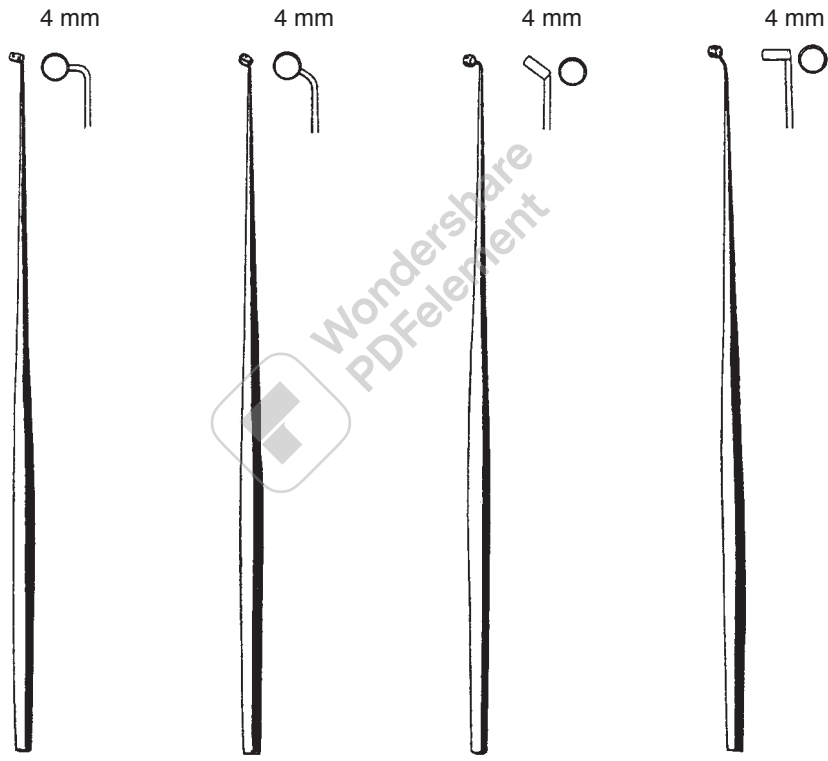

41221-00  
19 cm, 7 1/2"

41222-00  
19 cm, 7 1/2"

41223-00  
19 cm, 7 1/2"

41224-00  
19 cm, 7 1/2"

**HADEO**  
INSTRUMENTE GERMANY

Hypophysektomie Instrumente  
Pituitary Instruments  
Instrumentos para hipofisis  
Strumenti per ipofisi

**CUSHING-LANDOLT**

93600-01 70 x 15 mm

93600-02 90 x 15 mm

93600-03 110 x 15 mm

Spekula für trans-sphenoidale Hypophysektomie  
specula for trans-sphenoidale hypophysectomy  
especulos para hipofisectomía transfenoidal  
specoli per ipofisectomia trasfenoidale



**LANDOLT**  
93605-21  
210 mm, 8 1/4"

Spreizzange zum Spreizen der Spekula  
spreader for specula  
pinza para abrir el espejulo  
pinze per aprire gli specoli

**HADEO**  
INSTRUMENTE GERMANY

Hypophysektomie Instrumente  
Pituitary Instruments  
Instrumentos para hipófisis  
Strumenti per ipofisi



PAPAVERO-CASPAR  
93610-11 80 x 11 mm  
93610-13 90 x 13 mm  
93610-15 100 x 15 mm

Spekula für trans-sphenoidale Hypophysektomie  
specula for trans-sphenoidale hypophysectomy  
espéculos para hipofisectomía transfenoidal  
specoli per ipofisectomia trasfenoidale



PAPAVERO-HARTMANN  
93615-01  
140 mm, 5 1/2"

Spreizer für Spekula  
spreader for specula  
pinza para abrir el espéculo  
pinze per aprire gli specoli



LANDOLT  
93620-14  
215 mm, 8 1/2"



**HADEO**  
INSTRUMENTE GERMANY

Hypophysektomie-Instrumente  
Pituitary Instruments  
Instrumentos para hipofisis  
Strumenti per ipofisi

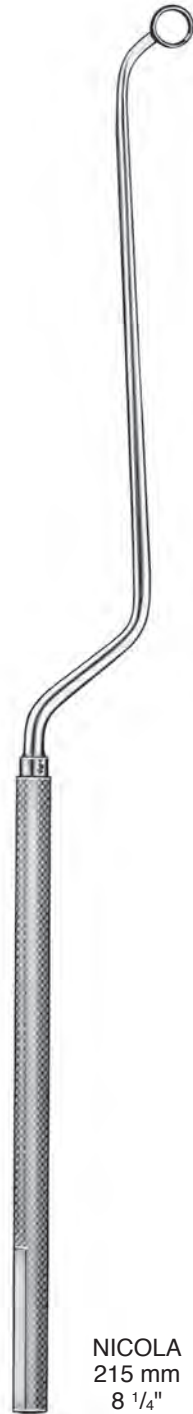

NICOLA  
215 mm  
8 1/4"

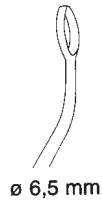

ø 6,5 mm

93660-01

Kürette, biegsam, nach rechts schneidend  
curette, malleable, cutting to the right  
cureta, maleable, cortante hacia la derecha  
curetta, malleabile, tagliente a destra



ø 6,5 mm

93660-02

Kürette, biegsam, nach links schneidend  
curette, malleable, cutting to the left  
cureta, maleable, cortante hacia la izquierda  
curetta, malleabile, tagliente a sinistra



ø 6,5 mm

93660-03

Kürette, biegsam  
curette, malleable  
cureta, maleable  
curetta, malleabile

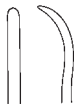

93660-04

Raspatorium  
raspatory  
legra  
raspatore

**HADEO**  
 INSTRUMENTE GERMANY

 Hypophysektomie-Instrumente  
 Pituitary Instruments  
 Instrumentos para hipófisis  
 Strumenti per ipofisi

 93670-01 245 mm / 9 3/4" rechts/right/derecha/a destra HARDY  
 93670-02 245 mm / 9 3/4" links/left/izquierda/a sinistra

 Eukleator, stumpf  
 enucleator, blunt  
 enucleador, romo  
 enucleatore, smusso

 93670-05 245 mm / 9 3/4" rechts/right/derecha/a destra HARDY  
 93670-06 245 mm / 9 3/4" links/left/izquierda/a sinistra

 Eukleator, scharf  
 enucleator, sharp  
 enucleador, cortante  
 enucleatore, tagliente

93670-09 245 mm / 9 3/4" HARDY

 Implantationsgabel  
 implant fork  
 horquilla de implante  
 forchetta per trapianti

93670-10 245 mm / 9 3/4" HARDY-FAHLBUSCH

 Dissektor, innen scharf  
 dissector sharpened inner edge  
 disector, lado interno cortante  
 disettore, lato interno sinistro tagliente

93670-12 245 mm / 9 3/4" HARDY-FAHLBUSCH

 Dissektor, innen scharf  
 dissector sharpened inner edge  
 disector, lado interno cortante  
 disettore, lato interno destro tagliente

**HADEO**  
 INSTRUMENTE GERMANY

 Hypophysektomie-Instrumente  
 Pituitary Instruments  
 Instrumentos para hipófisis  
 Strumenti per ipofisi

 93680-01 260 mm / 10 <sup>3</sup>/<sub>4</sub>" LANDOLT

rechts/right/derecha/a destra

 93680-02 260 mm / 10 <sup>3</sup>/<sub>4</sub>"

links/left/izquierda/a sinistra

Enukleator, stumpf, biegsam

enucleator, blunt, malleable

enucleador, romo, maleable

enucleatore, smusso, malleabile

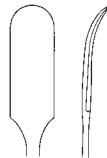

 93680-05 260 mm / 10 <sup>3</sup>/<sub>4</sub>" LANDOLT

Kürette, biegsam

curette, malleable

cureta, maleable

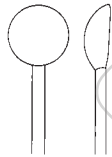
curetta, malleabile

 93680-06 260 mm / 10 <sup>3</sup>/<sub>4</sub>" LANDOLT

Löffel, biegsam

scoop, malleable

cucharilla, maleable

cucchiaio, malleabile

 93680-07 260 mm / 10 <sup>3</sup>/<sub>4</sub>" LANDOLT

stumpfes Hähchen, biegsam

blunt hook, malleable

gancho, romo, maleable

uncino smusso, malleabile

 93690-01 260 mm / 10 <sup>3</sup>/<sub>4</sub>" HOSOBUCHI

gabelförmige Spatel, fest

fork spatula, rigid

espátula forma horquilla, rígida

spatola forma a forchetta, rigida

**HADEO**  
INSTRUMENTE GERMANY

Hypophysenküretten  
Pituitary Currettes  
Cureta para hipófisis  
Curetta per ipofisi



**HARDY**  
24 cm, 9 1/2"  
93700-03 3 mm  
93700-05 5 mm

aufwärts gewinkelt  
angled up  
en ángulo hacia arriba  
angolato verso l'alto



**HARDY**  
24 cm, 9 1/2"  
93702-03 3 mm  
93702-05 5 mm

links gewinkelt  
left curved  
curvo hacia la izquierda  
curva a destra



**HARDY**  
24 cm, 9 1/2"  
93701-03 3 mm  
93701-05 5 mm

abwärts gewinkelt  
angled down  
ángulo hacia abajo  
angolato verso il basso



**HARDY**  
24 cm, 9 1/2"  
93703-03 3 mm  
93703-05 5 mm

rechts gewinkelt  
right curved  
curvo hacia la derecha  
curva a sinistra

**HADEO**  
INSTRUMENTE GERMANY

Hypophysektomie-Instrumente  
Pituitary Instruments  
Instrumentos para hipófisis  
Strumenti per ipofisi

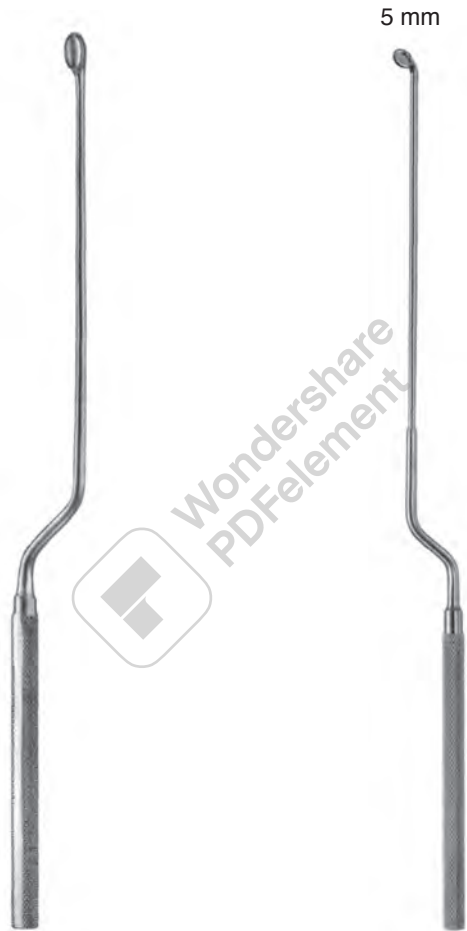

HARDY  
93704-24  
23,5 cm, 9 1/4"

Löffel, biegsam  
Spoon, malleable  
Cucharilla, maleable  
Cucchiaio, malleabile

HARDY  
93705-00  
23 cm, 9"

Mikrospiegel  
Micro mirror  
Micro espejo  
Micro-specchio

**HADEO**  
 INSTRUMENTE GERMANY

 Hypophysektomie-Instrumente  
 Pituitary Instruments  
 Instrumentos para hipófisis  
 Strumenti per ipofisi

93710-01 260 mm / 10 1/4" FAHLBUSCH

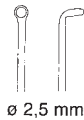
 Löffel, biegsam  
 scoop, malleable  
 cucharilla, maleable  
 cucchiaio, malleabile

93710-02 260 mm / 10 1/4" FAHLBUSCH

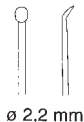
 Kürette, biegsam  
 curette, malleable  
 cureta, maleable  
 curetta, malleabile

93710-03 260 mm / 10 1/4" LANDOLT-REULEN

 Raspatorium, fest  
 raspatories, rigid  
 legra, rígida  
 raspatore, rigido

93710-04 260 mm / 10 1/4" LANDOLT-REULEN

 Raspatorium, fest  
 raspatories, rigid  
 legra, rígida  
 raspatore, rigido

93710-05 260 mm / 10 1/4" LANDOLT-REULEN

 Kürette, fest  
 curette, rigid  
 cureta, rígida  
 curetta, rigido



93710-06 260 mm / 10 1/4" LANDOLT-REULEN

 stumpfes Häkchen, fest  
 blunt hook, rigid  
 gancho, romo, rígido  
 uncino smusso, rigida

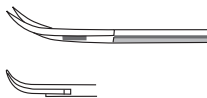
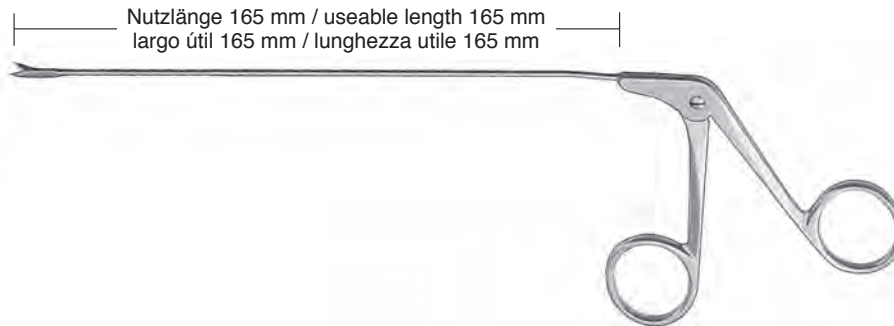

93710-07 260 mm / 10 1/4" LANDOLT-REULEN

 Dissektor, fest  
 dissector, rigid  
 disector, rígido  
 dissettore, rigida

**HADEO**  
 INSTRUMENTE GERMANY

 Hypophysektomie-Instrumente  
 Pituitary Instruments  
 Instrumentos para hipófisis  
 Strumenti per ipofisi

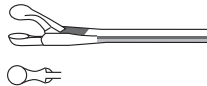
93720-01 165 mm / 6 1/2" FAHLBUSCH

 Mikro-Schere, gebogen, horizontal schneidend  
 Micro scissors, horizontal cutting  
 Micro-tijera, curva, cortante en forma horizontal  
 Micro forbice, curva, tagliante orizzontale

93720-02 165 mm / 6 1/2" NICOLA

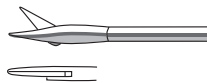
 Scharfe Zange  
 Forceps scoop-shaped  
 Pinza en forma de cuchara, cortante  
 Pinze tagliente

93720-03 165 mm / 6 1/2" NICOLA

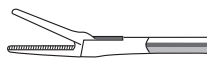
 Mikro-Schere, gerade  
 Micro Scissors, straight  
 Micro-tijera, recta  
 Micro forbice, retta

93720-04 165 mm / 6 1/2" YASARGIL-NICOLA

 Faßzange  
 Grasping Forceps  
 Pinza de agarre  
 Pinze da presa



Hypophysectomie-Instrumente  
 Pituitary Instruments  
 Instrumentos para hipófisis  
 Strumenti per ipofisi

Nutzlänge 80 mm / useable length 80 mm  
 largo útil 80 mm / lunghezza utile 80 mm

Mikrozangen  
 Micro forceps  
 Micro-pinzas  
 Micro pinze



4 mm



6 mm

gerade  
 straight  
 recta  
 retta



93730-04



93730-06

aufgebogen  
 angled up  
 curva hacia arriba  
 curva in alto



93731-04

Löffelzangen  
 Cup-shaped Forceps  
 Pinzas en forma de cuchara  
 Pinze, morso a forma di cucchiaio

gerade  
 straight  
 recta  
 retta

rund  
 round  
 redondo  
 rotondo



93740-01

oval  
 oval  
 oval  
 ovale



93740-02

Mikro-Scheren  
 Micro Scissors  
 Micro tijeras  
 Micro Forbici

gerade  
 straight  
 recta  
 retta



93750-01

rechts gebogen  
 curved right  
 curva hacia la derecha  
 curva a destra



93750-03

aufgebogen  
 angled up  
 curva hacia arriba  
 curva in alto



93750-02

links gebogen  
 curved left  
 curva hacia la izquierda  
 curva a sinistra



93750-04



HIRNSPATEL

BRAIN SPATULAS

ESPÁTULAS CEREBRALES

SPATOLE CEREBRALI

**HADEO**  
INSTRUMENTE GERMANY

[www.hadeo.co](http://www.hadeo.co)

# HADEO

INSTRUMENTE GERMANY

Hirnspatel  
Brain Spatulas  
Espátulas cerebrales  
Spatole cerebrali



biegsam  
malleable  
maleable  
malleabile

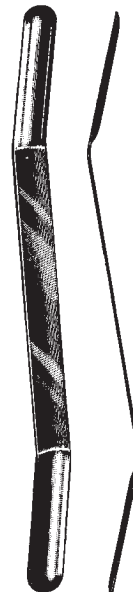

#### AACHEN

41249-07	7/8 x 200 mm
41249-10	10/11 x 200 mm
41249-13	13/14 x 200 mm
41249-16	16/17 x 200 mm
41249-19	19/20 x 200 mm
41249-22	22/25 x 200 mm

#### CUSHING

41250-11	8 x 10 mm
41250-15	13 x 15 mm
41250-18	16 x 18 mm

#### OLIVECRONA

41253-07	7/9 mm
41253-11	11/13 mm
41253-15	15/18 mm
41253-18	18/22 mm



Hirnspatel  
Brain Spatulas  
Espátulas cerebrales  
Spatole cerebrali



biegsam  
malleable  
maleable  
malleabile

DAVIS  
18 cm, 7"

- 41254-06 6 mm
- 41254-10 9 mm
- 41254-13 13 mm
- 41254-16 16 mm
- 41254-19 19 mm
- 41254-25 25 mm
- 41254-32 32 mm
- 41254-38 38 mm



200 mm / 8"  
41860-14 14 mm  
41860-17 17 mm  
41860-20 20 mm

155 mm / 6"  
41870-08 8 mm  
41870-11 11 mm  
41870-14 14 mm  
41870-17 17 mm

HEIFETZ

biegsam  
malleable  
maleable  
malleabile



biegsam  
malleable  
maleable  
malleabile

- 41880-01 9 x 200 mm, 8"
- 41880-02 12 x 200 mm, 8"
- 41880-03 12 x 250 mm, 10"

**HADEO**  
INSTRUMENTE GERMANY

LEYLA Retraktor System  
LEYLA Retractor System  
Separador de sistema LEYLA  
LEYLA Sistema di fissaggio



#### YASARGIL

41801-01 Hirnspatelhalter, flexibel, für 1 flachen Spatel, komplett, bestehend aus:  
brain retractor, flexible, for 1 flat spatula, complete, consisting of:  
separador autoretentivo, flexible, para espátula con 1 brazo flexible, completo, compuesto de:  
divaricatore autostatico, flessibile, per spatole piatte, con 1 braccio flessibile, completo, composto da:

41810-10 flexibler Spannarm  
flexible arm  
brazo flexible  
braccio flessibile

41826-26 Fixiervorrichtung für 1 flexiblen Spannarm  
fixation base for 1 flexible arm  
fijador para 1 brazo flexible  
fissatore per 1 braccio al braccio rigido

41830-30 Spatelhalter für flache Spatel  
support for flat brain spatula  
soporte para espátulas cerebrales planas  
sostegno per spatole piatte

#### YASARGIL

41802-02 Hirnspatelhalter, flexibel für 2 flache Spatel, komplett, bestehend aus:  
brain retractor, flexible, for 2 flat spatulas, complete, consisting of:  
separador autoretentivo, flexible, para 2 espátulas planas con 2 brazos flexibles, completo, compuesto de:  
divaricatore autostatico, flessibile, per spatole piatte, con 2 bracci flessibili, completo, composto da:

41810-10 flexibler Spannarm (2x)  
flexible arm (2x)  
brazo flexible (2x)  
braccio flessibile (2x)

41822-22 Fixiervorrichtung für 2 flexible Spannarme  
fixation base for 2 flexible arms  
fijador para 2 brazos  
fissatore per 2 bracci al cranio

41830-30 Spatelhalter für flache Spatel (2x)  
support for flat brain spatula (2x)  
soporte para espátulas cerebrales planas (2x)  
sostegno per spatole piatte (2x)



**HADEO**  
 INSTRUMENTE GERMANY

 LEYLA Retraktor System  
 LEYLA Retractor System  
 Separador de sistema LEYLA  
 LEYLA Sistema di fissaggio

41821-21

 Fixiervorrichtung für 1 flexiblen Spannarm zum Festschrauben an Rohrteilen bis  
 ø 16 mm

Fixation base for mounting on bars up to ø16 mm, for 1 flexible arm

Fijador para 1 brazo flexible, para atornillar a tubos hasta 16 mm

Fissatore per 1 braccio al braccio rigido

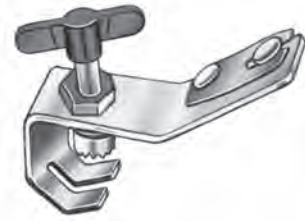

41822-22

Fixiervorrichtung für 2 flexible Spannarme zum Festschrauben am Schädel

Fixation base for skull mounting, holding 2 flexible arms

Fijador para 2 brazos flexibles, para atornillar al craneo

Fissatore per 2 bracci al cranio



41826-26

Fixiervorrichtung für 1 flexiblen Spannarm zum Festschrauben am Schädel

Fixation base for skull mounting, holding 1 flexible arm

Fijador para 1 brazos flexibles, para atornillar al craneo

Fissatore per 1 braccio al cranio



41830-30

Spatelhalter für flache Hirnspatel zur Befestigung am Spannarm

Support for flat brain spatula

Soporte para espátulas cerebrales planas para fijacion al brazo flexible

Sostegno per spatole piate



41832-32

Halter für Hirnspatel mit rundem Schaft bis ø 5,5 mm zur Befestigung am Spannarm

Support for brain spatula with round shaft

Soporte para espátulas cerebrales con mango redondo hasta ø 5,5 mm para

fijacion al brazo flexible

Sostegno flessibile per spatola cerebrale



**HADEO**  
INSTRUMENTE GERMANY

LEYLA Retraktor System  
LEYLA Retractor System  
Separador de sistema LEYLA  
LEYLA Sistema di fissaggio



YASARGIL

41810-10 flexibler Spannarm, allein  
flexible arm, only  
brazo flexible, suelto  
braccio flessibile, solo

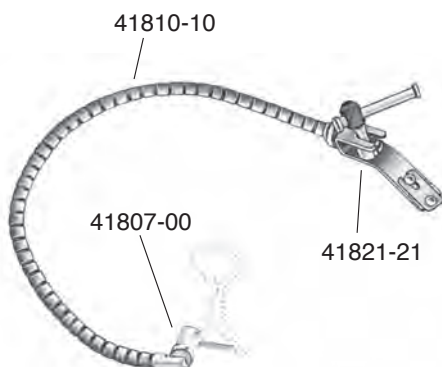

YASARGIL

41803-01 Ohrspekulahalter, komplett, bestehend aus:  
ear specula holder, complete, consisting of:  
soporte para espejos auriculares completo,  
compuesto de:  
sostegno per specolo auricolare, completo  
composto da:

41810-10 flexibler Spannarm  
flexible arm, only  
brazo flexible, suelto  
braccio flessibile, solo

41821-21 Fixiervorrichtung zum Befestigen an Rohrteilen  
bis Ø 16 mm  
clamp for fixation on bars up to Ø 16 mm  
fijador para 1 brazo flexible, para atornillar a  
tubos hasta 16 mm  
fissatore al braccio rigido Ø 16 mm

41807-00 Ohrtrichterhalter, allein  
ear specula holder, only  
soporte para espejos auriculares, suelto  
sostegno per specolo auricolare

**HADEO**  
 INSTRUMENTE GERMANY

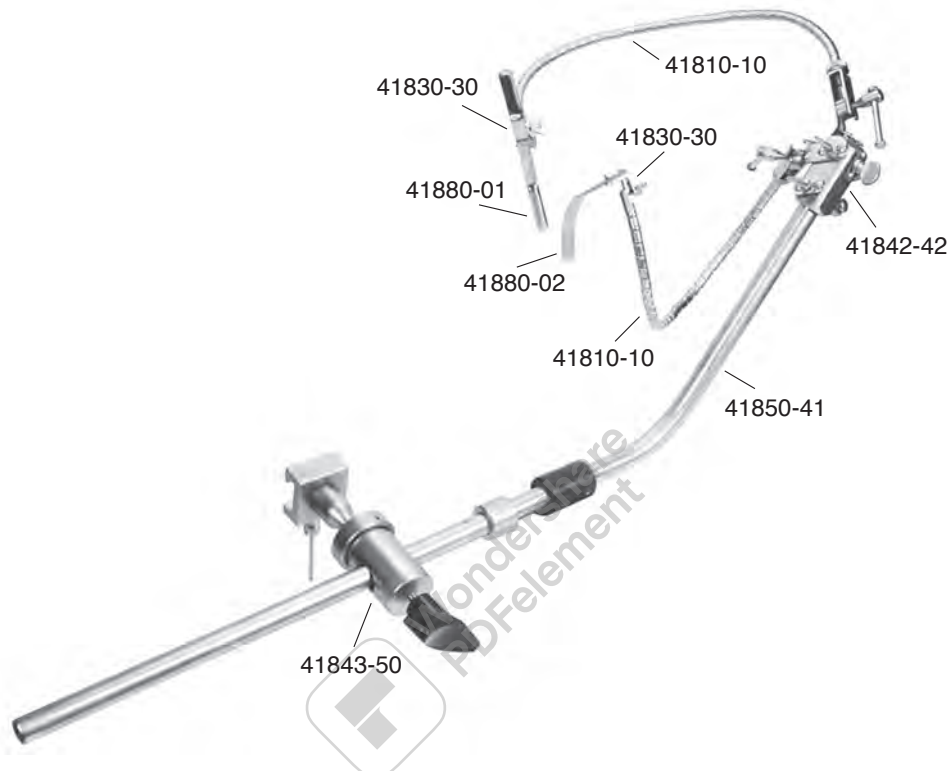
 LEYLA Retraktor System  
 LEYLA Retractor System  
 Separador de sistema LEYLA  
 LEYLA Sistema di fissaggio

41802-00 LEYLA-Retraktor-System zum Fixieren am OP-Tisch komplett, bestehend aus:

LEYLA Self-Retraining Retractor for fixation to operating table, complete, consisting of:

Separador LEYLA para fijación a la mesa de operaciones, completo, compuesto de:

LEYLA Sistema di fissaggio al tavolo operatorio, composto da:

- |   |  |
|---|--|
| 41843-50 Kugelgelenkkloben (1x)<br>ball and socket joint (1x)<br>articulacion esferica (1x)<br>giunto per fissare (1x)        | 41830-30 Spatelhalter für flache Spatel (2x)<br>support for flat brain spatula (2x)<br>soporte para espátulas cerebrales planas (2x)<br>sostegno per spatole piatte (2x) |
| 41850-41 starrer Haltearm (1x)<br>rigid holding rod (1x)<br>brazo de fijación rigido (1x)<br>braccio di fissaggio rigido (1x) | 41880-01 CUSHING Hirnspatel (1x)<br>CUSHING brain spatula (1x)<br>CUSHING espátula para cerebro (1x)<br>CUSHING spatola cerebrale (1x)                                   |
| 41842-42 Kupplungskopf (1x)<br>coupling head (1x)<br>cabeza de acoplamiento (1x)<br>giunto per combinare (1x)                 | 41880-02 CUSHING Hirnspatel (1x)<br>CUSHING brain spatula (1x)<br>CUSHING espátula para cerebro (1x)<br>CUSHING spatola cerebrale (1x)                                   |
| 41810-10 flexibler Spannarm (2x)<br>flexible arm, only (2x)<br>brazo flexible, suelto (2x)<br>braccio flessibile, solo (2x)   |  |

**HADEO**  
 INSTRUMENTE GERMANY

LEYLE Retraktor System  
 LEYLE Retractor System  
 Separador de sistema LEYLE  
 LEYLE Sistema di fissaggio



41843-50 Kugelgelenkkloben  
 zum Befestigen an der OP-Tisch-  
 schiene und zur Aufnahme des  
 Haltearms 41850-41

ball and socket joint  
 for fixation of holding rod 41850-41  
 at the operating table

articulacion esferica, para sujetar el  
 brazo de soporte rigido sobre la  
 mesa de operaciones 9 x 32 mm  
 giunto per fissare il braccio, articola-  
 to 9 x 32 mm



41850-41 starrer Haltearm, auseinandernehmbar, zur Fixation im  
 Kugelgelenkkloben 41843-50 und zur wahlweisen Auf-  
 nahme der Kupplungsköpfe 41842-42, 41842-44 und  
 41842-46

holding rod, detachable, for fixation in ball and socket  
 joint 41843-50 and to hold a desired coupling head  
 41842-42, 41842-44 or 41842-46

brazo de soporte rigido, desmontable, para fijacion a la  
 articulacion esferica 41843-50 y opcionalmente a las  
 cabezas 41842-42, 41842-44 y 41842-46

braccio di sostegno rigido, per fissaggio al giunto  
 41843-50 e dei giunti 41842-42, 41842-44 e 41842-46



41842-42 Kupplungskopf, zur Aufnahme von  
 max. 5 flexiblen Spannarmen  
 41810-10

coupling head to hold 5 flexible  
 arms 41810-10  
 cabeza de acoplamiento para fijar  
 hasta 5 brazos flexibles  
 giunto per combinare 5 bracci



41842-44 Kupplungskopf, drehbar, zur Aufnahme von 1 flexiblen  
 Spannarm 41810-10

coupling head, turnable, to hold 1 flexible arm 41810-10  
 acoplamiento, girable y se puede fijar en todas las  
 posturas para sujetar un brazo flexible 41810-10  
 giunto per combinare, rotabile, per sostegno del braccio  
 41810-10

41842-46 Kupplungskopf, seitlich offen zur Aufnahme von 1  
 flexiblen Spannarm 41810-10

coupling head, lateral open, to hold 1 flexible arm  
 41810-10  
 acoplamiento, abierto al lado, para un brazo flexible  
 41810-10  
 giunto per fissare il braccio, per 41810-10



STANZEN

PUNCHES

PINZAS SACABOCADO

PINZE LAMINOTOMO







[www.hadeo.co](http://www.hadeo.co)

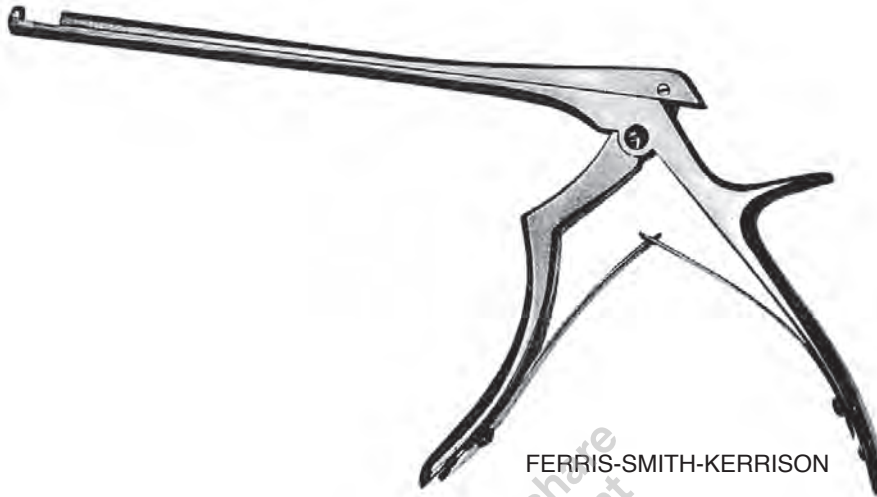

**HADEO**  
INSTRUMENTE GERMANY

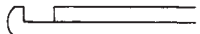
Bandscheibenstanzen  
Intervertebral Disc Rongeurs  
Pinzas sacabocado para discos intervertebrales  
Pinze taglienti per dischi intervertebrali

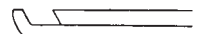
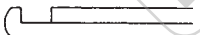
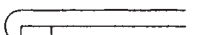
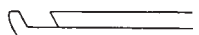
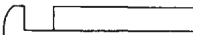
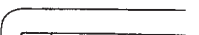
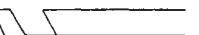
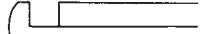

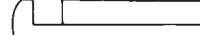
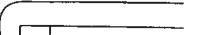
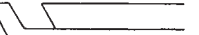
	90°	90°	40°
18 cm, 7" 20 cm, 8"	 41510-01 1 mm 41513-01 1 mm	 41511-01 1 mm 41514-01 1 mm	 41512-01 1 mm 41515-01 1 mm
18 cm, 7" 20 cm, 8"	 41510-02 2 mm 41513-02 2 mm	 41511-02 2 mm 41514-02 2 mm	 41512-02 2 mm 41515-02 2 mm
18 cm, 7" 20 cm, 8"	 41510-03 3 mm 41513-03 3 mm	 41511-03 3 mm 41514-03 3 mm	 41512-03 3 mm 41515-03 3 mm
18 cm, 7" 20 cm, 8"	 41510-04 4 mm 41513-04 4 mm	 41511-04 4 mm 41514-04 4 mm	 41512-04 4 mm 41515-04 4 mm
18 cm, 7" 20 cm, 8"	 41510-05 5 mm 41513-05 5 mm	 41511-05 5 mm 41514-05 5 mm	 41512-05 5 mm 41515-05 5 mm

auch lieferbar mit Dünnfuß  
also available with thin foot plate  
tambien disponible con lámina de punzonar estrecha  
anche disponibile con morso sottile





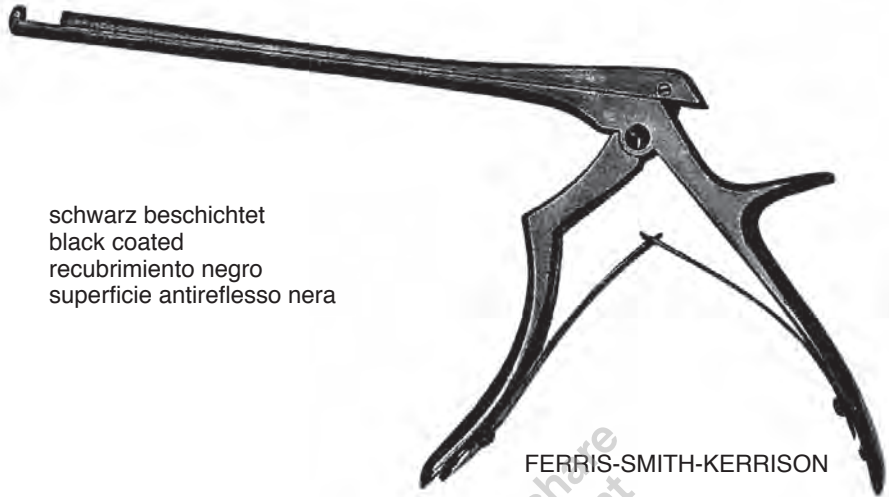

Bandscheibenstanzen  
 Intervertebral Disc Rongeurs  
 Pinzas sacabocado para discos intervertebrales  
 Pinze taglienti per dischi intervertebrali

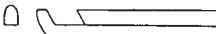
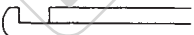

schwarz beschichtet  
 black coated  
 recubrimiento negro  
 superficie antireflesso nera

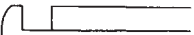
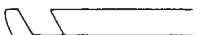
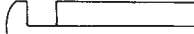
FERRIS-SMITH-KERRISON

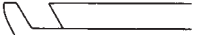
	90°		40°
18 cm, 7"	 41510-01B 1 mm		 41512-01B 1 mm
20 cm, 8"	41513-01B 1 mm		41515-01B 1 mm
18 cm, 7"	 41510-02B 2 mm		 41512-02B 2 mm
20 cm, 8"	41513-02B 2 mm		41515-02B 2 mm
18 cm, 7"	 41510-03B 3 mm		 41512-03B 3 mm
20 cm, 8"	41513-03B 3 mm		41515-03B 3 mm
18 cm, 7"	 41510-04B 4 mm		 41512-04B 4 mm
20 cm, 8"	41513-04B 4 mm		41515-04B 4 mm
18 cm, 7"	 41510-05B 5 mm		 41512-05B 5 mm
20 cm, 8"	41513-05B 5 mm		41515-05B 5 mm

**HADEO**  
INSTRUMENTE GERMANY

Bandscheibenstanzen, zerlegbar  
Intervertebral Disc Rongeurs, dismantable  
Pinzas sacabocado para discos intervertebrales, desmontable  
Pinze taglienti per dischi intervertebrali, smontabile a fucile

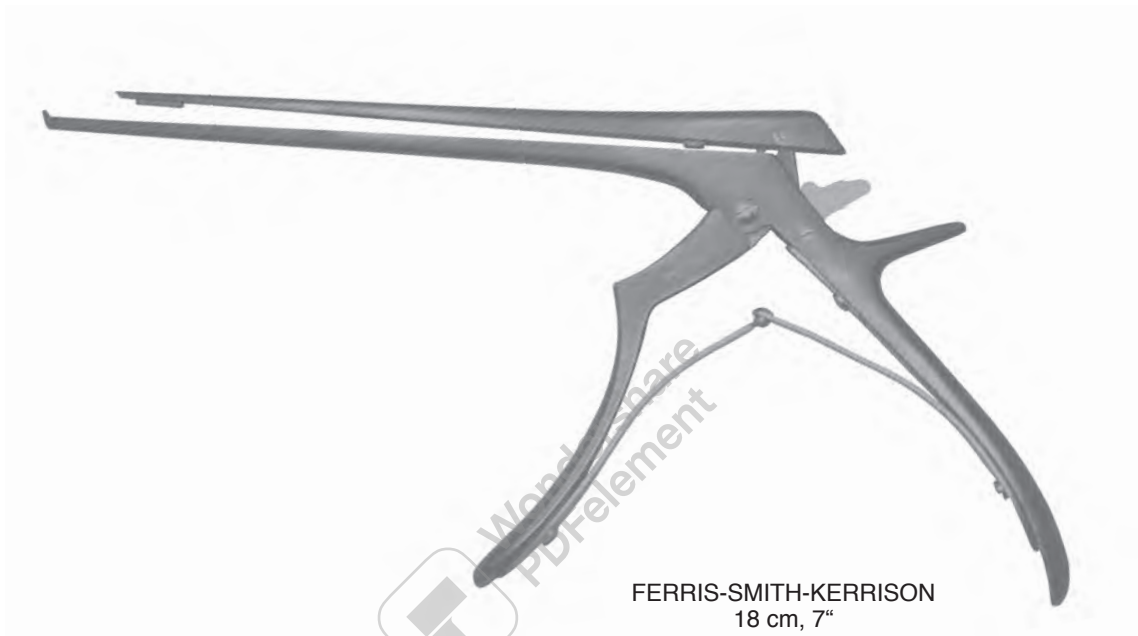

90°



41540-02 2 mm

41540-03 3 mm

41540-04 4 mm

41540-05 5 mm

130°



41542-02 2 mm

41542-03 3 mm

41542-04 4 mm

41542-05 5 mm

**HADEO**  
 INSTRUMENTE GERMANY

Bandscheibenstanzen, zerlegbar  
 Intervertebral Disc Rongeurs, dismantable  
 Pinzas sacabocado para discos intervertebrales, desmontable  
 Pinze taglianti per dischi intervertebrali, smontabile a fucile



90°

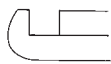

41540-02B 2 mm

41540-03B 3 mm

41540-04B 4 mm

41540-05B 5 mm

130°



41542-02B 2 mm

41542-03B 3 mm

41542-04B 4 mm

41542-05B 5 mm

**HADEO**  
INSTRUMENTE GERMANY

Bandscheibenstanzen  
Intervertebral Disc Rongeurs  
Pinzas sacabocado para discos intervertebrales  
Pinze taglienti per dischi intervertebrali

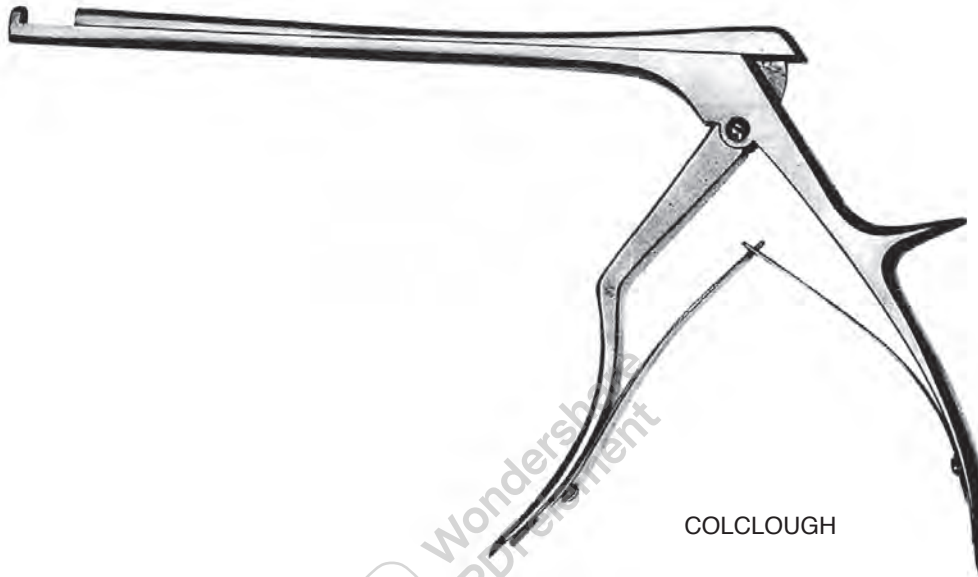

COLCLOUGH



3 mm  
41520-03 15 cm, 6"  
41522-03 20 cm, 8"



5 mm  
41520-05 15 cm, 6"  
41522-05 20 cm, 8"

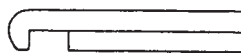

3 mm  
41524-03 15 cm, 6"  
41526-03 20 cm, 8"



5 mm  
41524-05 15 cm, 6"  
41526-05 20 cm, 8"

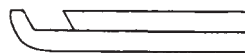

3 mm  
41527-03 15 cm, 6"  
41529-03 20 cm, 8"

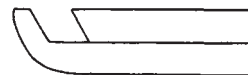

5 mm  
41527-05 15 cm, 6"  
41529-05 20 cm, 8"

**HADEO**  
INSTRUMENTE GERMANY

Stanzen  
Punches  
Pinzas  
Pinze-Punzoni



**KERRISON**  
17 cm, 6 3/4"  
3x3 mm 47303-03  
4x4 mm 47303-04  
5x5 mm 47303-05  
6x6 mm 47303-06

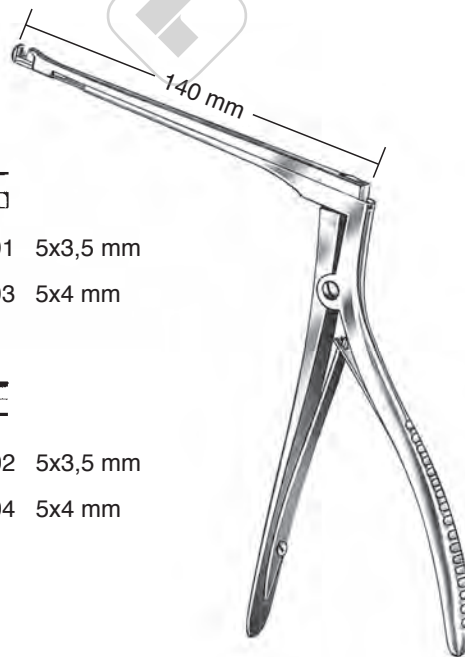

⌒ 47304-01 5x3,5 mm

⌒ 47304-03 5x4 mm



⌒ 47304-02 5x3,5 mm

⌒ 47304-04 5x4 mm

**HAJEK-KOFLER**  
47304-01 - 47304-04

**HADEO**  
INSTRUMENTE GERMANY

Stanzen  
Punches  
Pinzas  
Pinze-Punzoni



CITELLI  
47311-10 1,0 mm  
47311-25 2,5 mm  
47311-30 3,0 mm



HAJEK-KOFLER  
47316-16  
3,5 mm





CLIPS

CLIPS

CLIPS

CLIPS PER ANEURISMA



[www.hadeo.co](http://www.hadeo.co)

**HADEO**  
INSTRUMENTE GERMANY

YASARGIL – Aneurysmen – Gefäß – Clips  
 YASARGIL – Aneurysm – Vessel – Clips  
 YASARGIL – Clips para aneurisma  
 YASARGIL – Clips per aneurisma

aus hochwertigem Implantat-Stahl antimagnetisch  
 in high quality Implant steel antimagnetic  
 de acero inoxidable para implantes de alta calidad, antimagnético  
 Prodotto in acciaio di alta qualità, antimagnetico

## Features of the Clip

### SERIAL-NUMBER

Each clip is coded with an individual serial number – marked by laser technology-  
 The serial number guarantees a detailed follow-up of

- the whole production process
- the closure force
- from raw material to the final product

These informations are registered in our company for the period of 10 years.

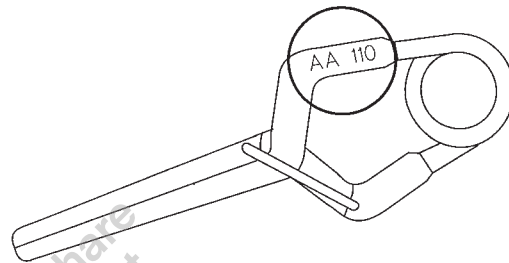

### PACKING – LABELING

Each clip is individually packaged in a transparent box made of resistant plastic.  
 Special wishes of customers regarding the packaging will be considered by us. This will be marked on an internal instruction.

The transparent box is marked with a label in order to assure a quick and sure identification of the clip.

On the label you can find the following data:

- catalogue number
- Product description
- Illustration
- Closing force in g
- Tolerance range of closing force
- Blade length
- Maximum opening
- Blade geometry
- Serial number
- Jaw profile
- Material description
- Lot number
- the notes "NOT STERILE"
- WARNING

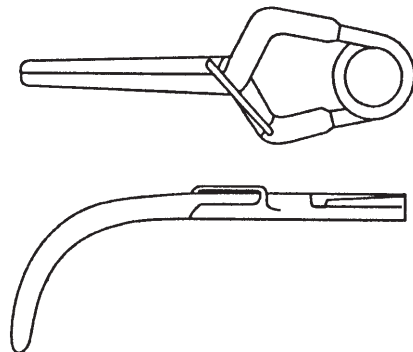

**HADEO**  
 INSTRUMENTE GERMANY

YASARGIL – Aneurysmen – Gefäß – Clips  
 YASARGIL – Aneurysm – Vessel – Clips  
 YASARGIL – Clips para aneurisma  
 YASARGIL – Clips per aneurisma

aus hochwertigem Implantat-Stahl antimagnetisch  
 in high quality Implant steel antimagnetic  
 de acero inoxidable para implantes de alta calidad, antimagnético  
 Prodotto in acciaio di alta qualità, antimagnetico

## Features of the Clip

### JAW-PROFILE

The rounded, pyramid-like structure is stamped into the jaw through a special step in production and prevents sharp edged which could perforate an aneurysm

No edges or burrs through additional rounding of structures that border the clip outer side because of this, real atraumatic application of the clip

Increased surface area due to the pyramid-like design of the jaws inner surface the cross-like structure of the inner jaws pyramid surface doubles the tissue-holding area.

The applied pressure distributes itself evenly over the length of the jaw.

The convex closure of the clip assures an atraumatic and secure closure of the aneurysm.

Sliding of the clip is prevented.

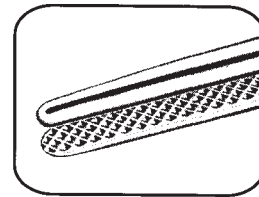
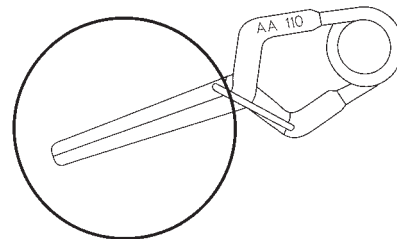

### SPRING-DESIGN

The spring size, which is different in the Standard and Mini clips, is the same within the same type of the Clip.

Through this, the highest degree of a secure fit is ensured by the clip applicator (clip/clip applicator fit)

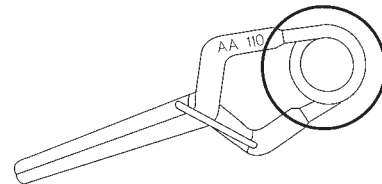

### LINK-DESIGN

Laser welded

The link ensures the precise guidance of the jaws and a "soft" opening of the clip during the whole spreading process.

The contact surface of the jaws are guided symmetrically in an exact way "over the whole length" this fact guarantees an additional stability of the clip.

No over-stress of the material because the design of the link limits the maximum opening width.

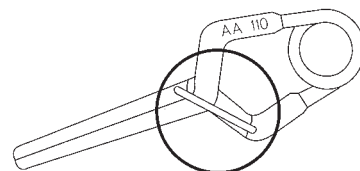

**HADEO**  
INSTRUMENTE GERMANY

YASARGIL – Aneurysmen – Gefäß – Clips  
YASARGIL – Aneurysm – Vessel – Clips  
YASARGIL – Clips para aneurisma  
YASARGIL – Clips per aneurisma

aus hochwertigem Implantat-Stahl antimagnetisch  
in high quality Implant steel antimagnetic  
de acero inoxidable para implantes de alta calidad, antimagnético  
Prodotto in acciaio di alta qualità, antimagnetico

## Features of the Clip

### CLOSING-FORCE

The closing force is measured at one third of the jaw length and an opening of 0,5 mm.

The final quality control of the clip is effected by a microprocessor-controlled measuring equipment.

The closing force is indicated exactly within a certain tolerance.

By the help of a special software program we assure that before the clip passes the final quality control its closure force is fixed.

As a consequence we exclude any kind of manipulation.

All relevant technical data are stored during the control procedure and printed on the label.

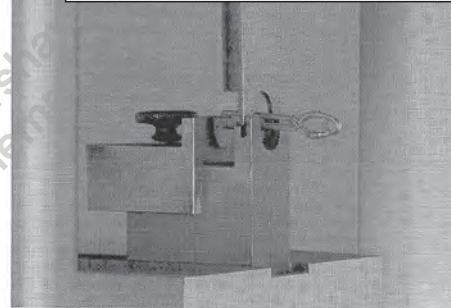
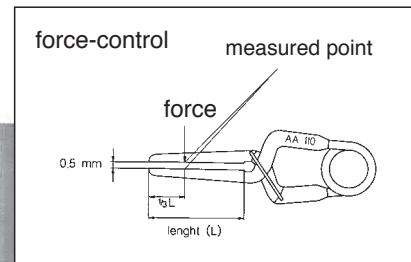

## Material and Quality Assurance

According to DIN 17445, implant steel is used in the production of our Aneurysm Clip

High stability characteristics

Excellent tissue compatibility

Secure closure of blood vessels

Antimagnetic

Ideally suited as implantation material

Security against over straining

**HADEO**  
INSTRUMENTE GERMANY

YASARGIL – Aneurysmen – Gefäß – Clips  
YASARGIL – Aneurysm – Vessel – Clips  
YASARGIL – Clips para aneurisma  
YASARGIL – Clips per aneurisma

aus hochwertigem Implantat-Stahl antimagnetisch  
in high quality Implant steel antimagnetic  
de acero inoxidable para implantes de alta calidad, antimagnético  
Prodotto in acciaio di alta qualità, antimagnetico

Erklärung zum Katalog-System  
Instructions for the catalogue-system  
Explicaciones para el sistema del catálogo  
Esempio del sistema del catalogo

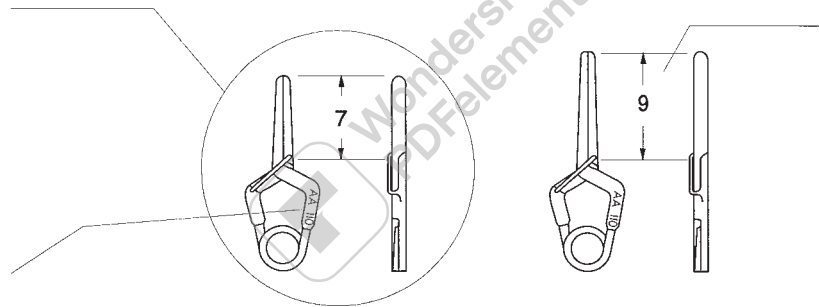



YASARGIL – Aneurysmen – Gefäß – Clips  
 YASARGIL – Aneurysm – Vessel – Clips  
 YASARGIL – Clips para aneurisma  
 YASARGIL – Clips per aneurisma

aus hochwertigem Implantat-Stahl antimagnetisch  
 in high quality Implant steel antimagnetic  
 de acero inoxidable para implantes de alta calidad, antimagnético  
 Prodotto in acciaio di alta qualità, antimagnetico

YASARGIL-STANDARD für permanenten Verschluss  
 YASARGIL-STANDARD for permanent closure  
 YASARGIL-STANDARD para cierre permanente  
 YASARGIL-STANDARD con chiusura permanente

Standard

Cat. Nr.	41600-62	41600-70	41600-78	41600-92	41601-10	41601-11
	<b>41600-62 T</b>	<b>41600-70 T</b>	<b>41600-78 T</b>	<b>41600-92 T</b>	<b>41601-10 T</b>	<b>41601-11 T</b>
max. opening	6,2 mm	7,0 mm	7,8 mm	9,2 mm	10,6 mm	11,4 mm
Force	150 gms	180 gms	180 gms	200 gms	200 gms	200 gms
	41601-13	41602-60	41602-68	41602-75	41602-87	41603-55
	<b>41601-13 T</b>	<b>41602-60 T</b>	<b>41602-68 T</b>	<b>41602-75 T</b>	<b>41602-87 T</b>	<b>41603-55 T</b>
	13,3 mm	6,0 mm	6,8 mm	7,5 mm	8,7 mm	5,5 mm
	200 gms	150 gms	180 gms	180 gms	200 gms	150 gms
	41603-61	41603-65	41603-74	41604-54	41604-58	41604-62
	<b>41603-61 T</b>	<b>41603-65 T</b>	<b>41603-74 T</b>	<b>41604-54 T</b>	<b>41604-58 T</b>	<b>41604-62 T</b>
	6,1 mm	6,5 mm	7,4 mm	5,4 mm	5,8 mm	6,2 mm
	180 gms	180 gms	200 gms	180 gms	180 gms	200 gms
	41604-79	41604-87	41604-87	41604-87	41604-87	41604-87
	<b>41604-79 T</b>	<b>41604-87 T</b>	<b>41604-87 T</b>	<b>41604-87 T</b>	<b>41604-87 T</b>	<b>41604-87 T</b>
	7,9 mm	8,7 mm	8,7 mm	8,7 mm	8,7 mm	8,7 mm
	200 gms	200 gms	200 gms	200 gms	200 gms	200 gms



YASARGIL – Aneurysmen – Gefäß – Clips  
 YASARGIL – Aneurysm – Vessel – Clips  
 YASARGIL – Clips para aneurisma  
 YASARGIL – Clips per aneurisma

aus hochwertigem Implantat-Stahl antimagnetisch  
 in high quality Implant steel antimagnetic  
 de acero inoxidable para implantes de alta calidad, antimagnético  
 Prodotto in acciaio di alta qualità, antimagnetico

YASARGIL-STANDARD für permanenten Verschluss  
 YASARGIL-STANDARD for permanent closure  
 YASARGIL-STANDARD para cierre permanente  
 YASARGIL-STANDARD con chiusura permanente

Standard

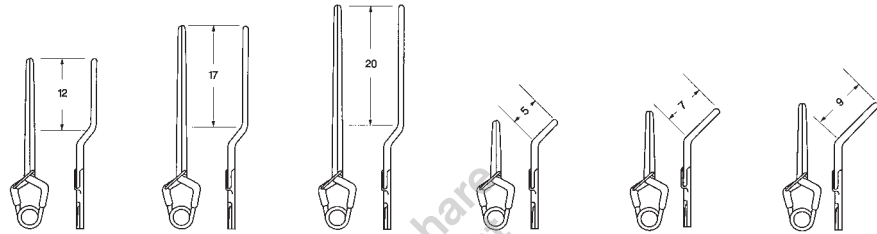

Cat. Nr.	41605-10 <b>41605-10 T</b>	41605-12 <b>41605-12 T</b>	41605-13 <b>41605-13 T</b>	41606-62 <b>41606-62-T</b>	41606-65 <b>41606-65 T</b>	41606-78 <b>41606-78 T</b>
max. opening Force	10,2 mm 200 gms	11,9 mm 180 gms	13,0 mm 180 gms	6,2 mm 200 gms	6,5 mm 200 gms	7,8 mm 200 gms

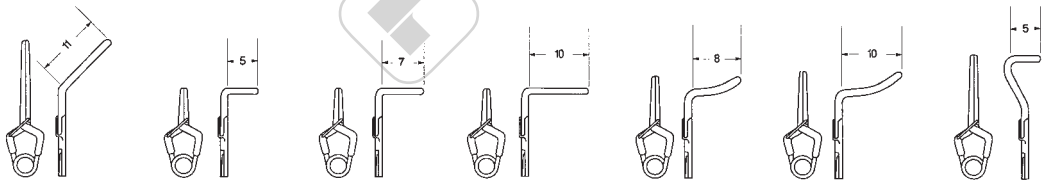

41606-84 <b>41606-84 T</b>	41607-56 <b>41607-56 T</b>	41607-57 <b>41607-57 T</b>	41607-58 <b>41607-58 T</b>	41607-59 <b>41607-59 T</b>	41607-60 <b>41607-60 T</b>	41607-72 <b>41607-72 T</b>
8,4 mm 200 gms	5,6 mm 200 gms	5,6 mm 200 gms	5,6 mm 200 gms	5,4 mm 200 gms	5,6 mm 200 gms	7,2 mm 200 gms

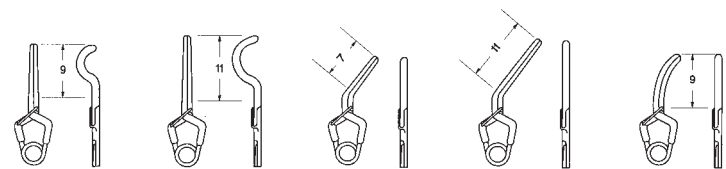

41607-73 <b>41607-73 T</b>	41607-82 <b>41607-82 T</b>	41608-57 <b>41608-57 T</b>	41608-80 <b>41608-80 T</b>	41609-70 <b>41609-70 T</b>
7,2 mm 200 gms	8,2 mm 200 gms	5,7 mm 200 gms	8,0 mm 200 gms	7,0 mm 200 gms

# HADEO

INSTRUMENTE GERMANY

YASARGIL – Aneurysmen – Gefäß – Clips  
 YASARGIL – Aneurysm – Vessel – Clips  
 YASARGIL – Clips para aneurisma  
 YASARGIL – Clips per aneurisma

aus hochwertigem Implantat-Stahl antimagnetisch  
 in high quality Implant steel antimagnetic  
 de acero inoxidable para implantes de alta calidad, antimagnético  
 Prodotto in acciaio di alta qualità, antimagnetico

YASARGIL-STANDARD für temporären Verschluss  
 YASARGIL-STANDARD for temporary closure  
 YASARGIL-STANDARD para cierre temporal  
 YASARGIL-STANDARD con chiusura temporanea

## Standard

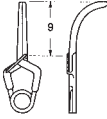
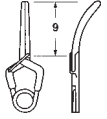
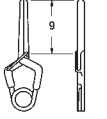
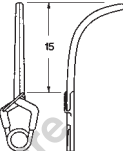
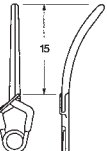
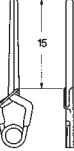
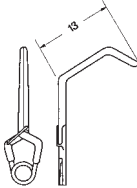
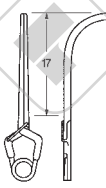
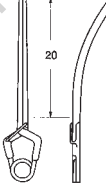
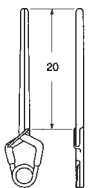
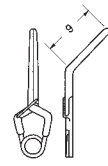
						
Cat. Nr.	41610-61	41610-68	41610-70	41611-74	41611-87	41611-92
	<b>41610-61 T</b>	<b>41610-68 T</b>	<b>41610-70 T</b>	<b>41611-74 T</b>	<b>41611-87 T</b>	<b>41611-92 T</b>
max. opening	6,1 mm	6,8 mm	7,0 mm	7,4 mm	8,7 mm	9,2 mm
Force	70 gms	70 gms	70 gms	70 gms	70 gms	70 gms
						
	41612-07	41612-09	41612-11	41612-12	41612-62	
	<b>41612-07 T</b>	<b>41612-09 T</b>	<b>41612-11 T</b>	<b>41612-12 T</b>	<b>41612-62 T</b>	
	7,5 mm	9,9 mm	11,0 mm	11,4 mm	6,2 mm	
	90 gms	90 gms	90 gms	90 gms	70 gms	



**HADEO**  
 INSTRUMENTE GERMANY

YASARGIL – Aneurysmen – Gefäß – Clips  
 YASARGIL – Aneurysm – Vessel – Clips  
 YASARGIL – Clips para aneurisma  
 YASARGIL – Clips per aneurisma

aus hochwertigem Implantat-Stahl antimagnetisch  
 in high quality Implant steel antimagnetic  
 de acero inoxidable para implantes de alta calidad, antimagnético  
 Prodotto in acciaio di alta qualità, antimagnetico

YASARGIL-STANDARD für permanenten Verschluss  
 YASARGIL-STANDARD for permanent closure  
 YASARGIL-STANDARD para cierre permanente  
 YASARGIL-STANDARD con chiusura permanente

**Standard**

Cat. Nr.	41613-74	41613-84	41613-96	41614-58	41614-65	41614-72
	<b>41613-74 T</b>	<b>41613-84 T</b>	<b>41613-96 T</b>	<b>41614-58 T</b>	<b>41614-65 T</b>	<b>41614-72 T</b>
max. opening	7,4 mm	8,4 mm	9,6 mm	5,8 mm	6,5 mm	7,2 mm
Force	150 gms	150 gms	180 gms	150 gms	150 gms	180 gms
	41615-49	41615-50	41615-51			
	<b>41615-49 T</b>	<b>41615-50 T</b>	<b>41615-51 T</b>			
	4,9 mm	4,9 mm	4,9 mm			
	150 gms	150 gms	180 gms			

**HADEO**  
INSTRUMENTE GERMANY

YASARGIL – Aneurysmen – Gefäß – Clips  
YASARGIL – Aneurysm – Vessel – Clips  
YASARGIL – Clips para aneurisma  
YASARGIL – Clips per aneurisma

aus hochwertigem Implantat-Stahl antimagnetisch  
in high quality Implant steel antimagnetic  
de acero inoxidable para implantes de alta calidad, antimagnético  
Prodotto in acciaio di alta qualità, antimagnetico

YASARGIL-STANDARD für permanenten Verschluss  
YASARGIL-STANDARD for permanent closure  
YASARGIL-STANDARD para cierre permanente  
YASARGIL-STANDARD con chiusura permanente

### Standard

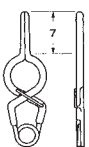
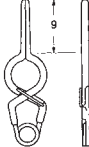
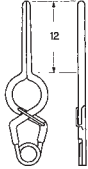
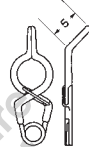
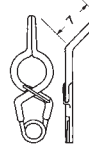
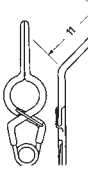
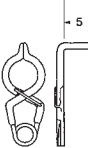
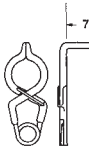
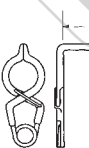
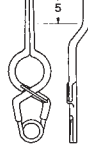
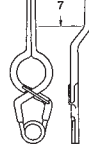
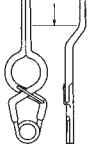
						
Cat. Nr.	41616-79	41616-91	41617-10	41617-65	41617-72	41617-78
max. opening	7,9 mm	9,1 mm	10,3 mm	6,5 mm	7,2 mm	7,8 mm
Force	150 gms	150 gms	180 gms	150 gms	150 gms	180 gms
						
	41618-55	41618-56	41618-57	41618-79	41618-88	41619-00
	41618-55 T	41618-56 T	41618-57 T	41618-79 T	41618-88 T	41619-00 T
	5,5 mm	5,5 mm	5,5 mm	7,9 mm	8,8 mm	10,0 mm
	150 gms	150 gms	180 gms	150 gms	150 gms	180 gms



YASARGIL – Aneurysmen – Gefäß – Clips  
 YASARGIL – Aneurysm – Vessel – Clips  
 YASARGIL – Clips para aneurisma  
 YASARGIL – Clips per aneurisma

aus hochwertigem Implantat-Stahl antimagnetisch  
 in high quality Implant steel antimagnetic  
 de acero inoxidable para implantes de alta calidad, antimagnético  
 Prodotto in acciaio di alta qualità, antimagnetico

YASARGIL-STANDARD für permanenten Verschluss  
 YASARGIL-STANDARD for permanent closure  
 YASARGIL-STANDARD para cierre permanente  
 YASARGIL-STANDARD con chiusura permanente

Standard

Cat. Nr.	41620-58	41620-59	41620-60	41620-61	41620-62	41620-63
max. opening	5,8 mm	5,8 mm	5,8 mm	5,8 mm	5,8 mm	5,8 mm
Force	150 gms	150 gms	150 gms	150 gms	150 gms	150 gms
	41620-70	41620-78	41620-88	41621-58	41621-62	41622-58
	41620-70 T	41620-78 T	41620-88 T	41621-58 T	41621-62 T	41622-58 T
	7,0 mm	7,8 mm	8,8 mm	5,8 mm	6,2 mm	5,8 mm
	150 gms	150 gms	150 gms	150 gms	150 gms	150 gms
	41623-56	41624-56	41625-56	41626-56		
	41623-56 T	41624-56 T	41625-56 T	41626-56 T		
	5,6 mm	5,6 mm	5,6 mm	5,6 mm		
	150 gms	150 gms	150 gms	150 gms		



YASARGIL – Aneurysmen – Gefäß – Clips  
 YASARGIL – Aneurysm – Vessel – Clips  
 YASARGIL – Clips para aneurisma  
 YASARGIL – Clips per aneurisma

aus hochwertigem Implantat-Stahl antimagnetisch  
 in high quality Implant steel antimagnetic  
 de acero inoxidable para implantes de alta calidad, antimagnético  
 Prodotto in acciaio di alta qualità, antimagnetico

YASARGIL-STANDARD für permanenten Verschluss  
 YASARGIL-STANDARD for permanent closure  
 YASARGIL-STANDARD para cierre permanente  
 YASARGIL-STANDARD con chiusura permanente

Mini

Cat. Nr.	41627-33	41627-40	41628-33	41628-40	41628-46	41629-32
	<b>41627-33 T</b>	<b>41627-40 T</b>	<b>41628-33 T</b>	<b>41628-40 T</b>	<b>41628-46 T</b>	<b>41629-32 T</b>
max. opening	3,3 mm	4,0 mm	3,3 mm	4,0 mm	4,6 mm	3,2 mm
Force	110 gms	110 gms	110 gms	110 gms	110 gms	110 gms
	41629-38	41630-36	41630-38	41631-36	41631-40	41631-44
	<b>41629-38 T</b>	<b>41630-36 T</b>	<b>41630-38 T</b>	<b>41631-36 T</b>	<b>41631-40 T</b>	<b>41631-44 T</b>
	3,8 mm	3,6 mm	3,8 mm	3,6 mm	4,0 mm	4,4 mm
	110 gms	110 gms	110 gms	110 gms	110 gms	110 gms
	41633-35	41633-40	41634-35	41634-60	41634-70	41635-57
	<b>41633-35 T</b>	<b>41633-40 T</b>	<b>41634-35 T</b>	<b>41634-60 T</b>	<b>41634-70 T</b>	<b>41635-57 T</b>
	3,5 mm	4,0 mm	3,5 mm	6,0 mm	7,0 mm	5,7 mm
	110 gms	110 gms	130 gms	130 gms	130 gms	130 gms
	41636-45					
	<b>41636-45 T</b>					
	4,5 mm					
	130 gms					







**HADEO**  
 INSTRUMENTE GERMANY

YASARGIL – Aneurysmen – Gefäß – Clips  
 YASARGIL – Aneurysm – Vessel – Clips  
 YASARGIL – Clips para aneurisma  
 YASARGIL – Clips per aneurisma

aus hochwertigem Implantat-Stahl antimagnetisch  
 in high quality Implant steel antimagnetic  
 de acero inoxidable para implantes de alta calidad, antimagnético  
 Prodotto in acciaio di alta qualità, antimagnetico

YASARGIL-STANDARD für temporären Verschluss  
 YASARGIL-STANDARD for temporary closure  
 YASARGIL-STANDARD para cierre temporal  
 YASARGIL-STANDARD con chiusura temporanea

**Mini**

						
Cat. Nr.	41637-33 <b>41637-33 T</b>	41637-40 <b>41637-40 T</b>	41638-38 <b>41638-38 T</b>	41638-46 <b>41638-46 T</b>	41639-44 <b>41639-44 T</b>	41640-40 <b>41640-40 T</b>
max. opening	3,3 mm	4,0 mm	3,8 mm	4,6 mm	4,4 mm	4,0 mm
Force	50 gms	50 gms	50 gms	70 gms	70 gms	70 gms

**HADEO**  
INSTRUMENTE GERMANY

Anlegezange mit Rundgriff – FLEXIBEL – mit und ohne drehbarem Maulteil  
 Applying forceps with round shaft – FLEXIBLE – with and without rotation  
 Pinzas de aplicaci3n con mango redondo – FLEXIBLE – con y sin rotaci3n  
 Posa clips con manico rotondo guaina flessibile con sistema rotante ed non rotante

Länge		
Length		
Largo		
Lunghezza	MINI	STANDARD
70 mm	41641-07	41643-07
90 mm	41641-09	41643-09
110 mm	41641-11	41643-11

nicht drehbar  
 non rotating  
 no giratorio  
 non rotante

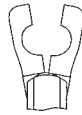

Länge		
Length		
Largo		
Lunghezza	MINI	STANDARD
70 mm	41642-07	41644-07
90 mm	41642-09	41644-09
110 mm	41642-11	41644-11

drehbar  
 rotating  
 giratorio  
 rotante



drehbar  
 rotating  
 giratorio  
 rotante

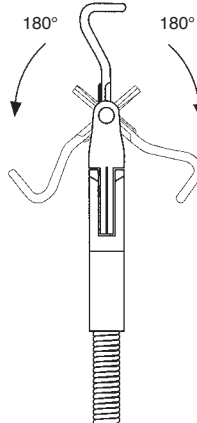

Beispiel für Drehmechanismus  
 Example for rotation  
 Ejemplo del mecanismo giratorio  
 Esempio della rotazione

Clips drehbar im Maul  
 Clips rotabile in jaw  
 Clips giratorios en la boca  
 Clips rotabile nel morso

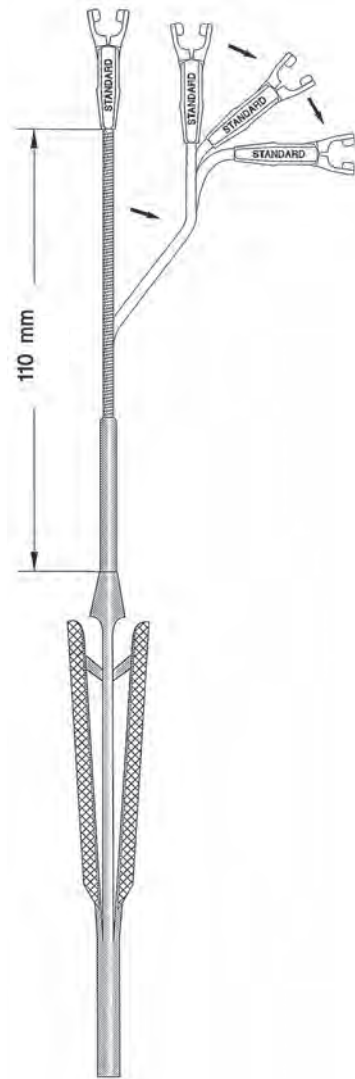

41641-07 - 41644-11



Anlegezange mit Rundgriff – starr – mit und ohne drehbarem Maulteil  
 Applying forceps with round shaft – rigid – with and without rotation  
 Pinzas de aplicación con mango redondo – rigido – con y sin rotación  
 Posa clips con manico rotondo guaina rigida con sistema rotante ed non rotante

Länge		
Length		
Largo		
Lunghezza	MINI	STANDARD
70 mm	41645-07	41647-07
90 mm	41645-09	41647-09
110 mm	41645-11	41647-11

nicht drehbar  
 non rotating  
 no giratorio  
 non rotante

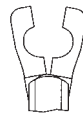

Länge		
Length		
Largo		
Lunghezza	MINI	STANDARD
70 mm	41646-07	41648-07
90 mm	41646-09	41648-09
110 mm	41646-11	41648-11

drehbar  
 rotating  
 giratorio  
 rotante



drehbar  
 rotating  
 giratorio  
 rotante

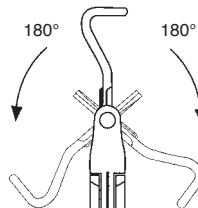

Beispiel für Drehmechanismus  
 Example for rotation  
 Ejemplo del mecanismo giratorio  
 Esempio della rotazione

Clips drehbar im Maul  
 Clips rotabile in jaw  
 Clips giratorios en la boca  
 Clips rotabile nel morso

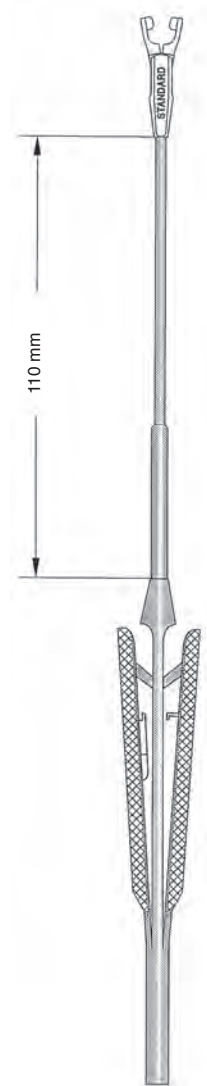

41645-07 - 41648-11

**HADEO**  
INSTRUMENTE GERMANY

Anlegezange mit Rundgriff – starr – mit und ohne drehbarem Maulteil  
 Applying forceps with round shaft – rigid – with and without rotation  
 Pinzas de aplicación con mango redondo – rígido – con y sin rotación  
 Posa clips con manico rotondo guaina rigida con sistema rotante ed non rotante

Länge		
Length		
Largo		
Lunghezza	MINI	STANDARD
70 mm	41649-07	41651-07
90 mm	41649-09	41651-09
110 mm	41649-11	41651-11

nicht drehbar  
 non rotating  
 no giratorio  
 non rotante

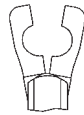

Länge		
Length		
Largo		
Lunghezza	MINI	STANDARD
70 mm	41650-07	41652-07
90 mm	41650-09	41652-09
110 mm	41650-11	41652-11

drehbar  
 rotating  
 giratorio  
 rotante



drehbar  
 rotating  
 giratorio  
 rotante

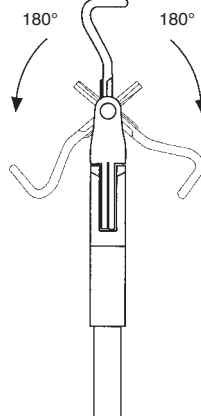

Beispiel für Drehmechanismus  
 Example for rotation  
 Ejemplo del mecanismo giratorio  
 Esempio della rotazione

Clips drehbar im Maul  
 Clips rotabile in jaw  
 Clips giratorios en la boca  
 Clips rotabile nel morso

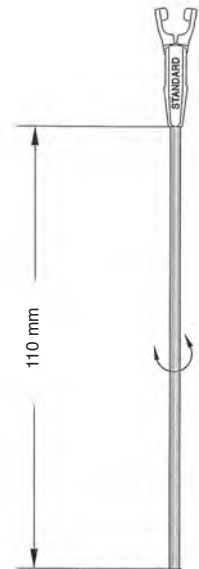

41649-07 - 41652-11



**HADEO**  
INSTRUMENTE GERMANY

Anlegezange – mit und ohne drehbarem Maulteil  
Applying Forceps – with and without rotation  
Pinzas de aplicación, con y sin rotación  
Pinza posa clips, con ed senza rotazione

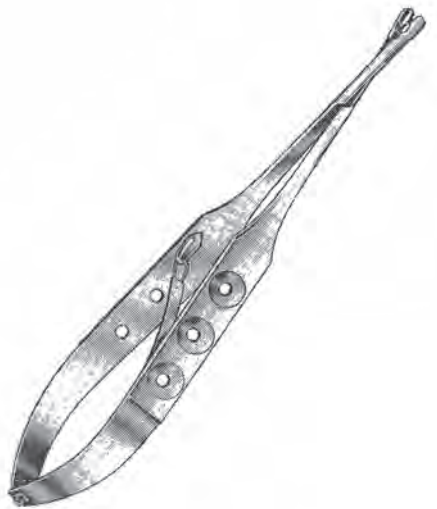

MINI 41653-18  
STANDARD 41654-18  
MINI 41655-18 drehbar / rotating  
giratorio / rotante  
STANDARD 41656-18 drehbar / rotating  
giratorio / rotante

Anlegezange gerade, mit Sperre, Länge 18 cm, 7"  
Applying Forceps straight, with ratchet, Length 18 cm, 7"  
Pinza de aplicación, con cremallera, 18 cm, 7"  
Posa clips, retta con bloccaggio lunghezza 18 cm, 7"





Länge  
Length  
Largo  
Lunghezza 17 cm, 6 <sup>3</sup>/<sub>4</sub>" 21 cm, 8 <sup>1</sup>/<sub>4</sub>" 23 cm, 9"  
MINI 41657-17 41657-21 41657-23  
STANDARD 41658-17 41658-21 41658-23  
MINI 41659-17 41659-21 41659-23  
drehbar / rotating / giratorio / rotante  
STANDARD 41660-17 41660-21 41660-23  
drehbar / rotating / giratorio / rotante

Clips drehbar im Maul  
Clips rotabile in jaw  
Clips giratorios en la boca  
Clips rotabile nel morso

Anlegezange bayonett, mit Sperre  
Applying Forceps bajonett, with ratchet  
Pinza de aplicación bayoneta, con cremallera  
Posa clips a baionetta con bloccaggio

**HADEO**  
 INSTRUMENTE GERMANY

Gefäßclips nach BIEMER  
 BIEMER Vessel Clips  
 Clips para vasos de BIEMER  
 Clips per vasi secondo BIEMER

	Maulöffnung Opening	Maullänge Length of jaws	Schließkraft Closing Force
 41661-40	4,0 mm	6,0 mm	30 - 40 g (0,29 - 0,39 N)
 41661-50	5,0 mm	9,0 mm	30 - 40 g (0,29 - 0,39 N)
 41662-50	5,0 mm	9,0 mm	20 - 25 g (0,20 - 0,25 N)

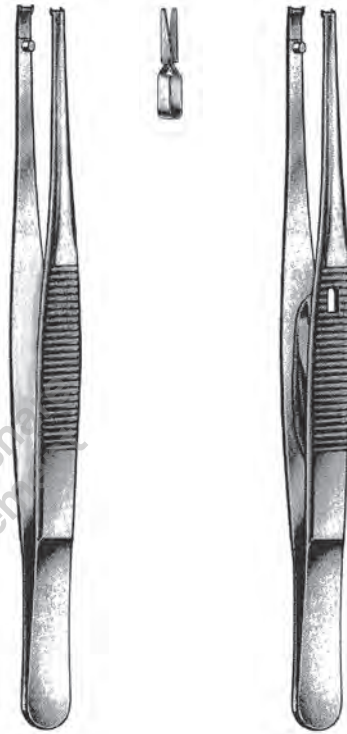

für temporären Gebrauch

gekennzeichnet durch gelb eingefärbte Federenden für  
 Gefäße mit einem Durchmesser 0,5 - 2,0 mm

Maulinnenflächen schräg gerieft für schonendes, sicheres  
 Festhalten der Gefäße

Der fest eingestellte Schließdruck gewährt risikofreie An-  
 wendung

for temporary occlusion

(identified by yellow coloured spring ends) for vessel diam.  
 0,5 - 2,0 mm

Blade gripping surface with oblique serrations for save but  
 careful gripping of vessels

No risk due to rigidly fixed pressure measure

para uso temporal

clips marcados con baño dorado en los resortes, para  
 vasos con un diámetro de 0,5 - 2,0 mm

El interior de las quijadas viene con estrias finas para un  
 agarre seguro y cuidadoso de los vasos

Debido a la calibración exacta de la fuerza de cierre se  
 ofrece una aplicación sin riesgo

per chiusura temporanea

per vasi con Diametro 0,5 - 2,0 mm

La chiusura regolata garantisce nessun rischio

BIEMER  
 41663-01

Anlegepinzette ohne Schloß,  
 für Mikro-Gefäßclips  
 41661-40 - 41662-50  
 und  
 Approximatoren  
 41667-30 - 41670-50  
 und  
 41672-01 - 41672-04

Applying forceps without lock.  
 for vessel clips  
 41661-40 - 41662-50  
 and  
 Aproximators  
 41667-30 - 41670-50  
 and  
 41672-01 - 41672-04

BIEMER  
 41663-02

Anlegepinzette mit Schloß,  
 für Mikro-Gefäßclips  
 41661-40 - 41662-50  
 und  
 Approximatoren  
 41667-30 - 41670-50  
 und  
 41672-01 - 41672-04

Applying forceps with lock.  
 for vessel clips  
 41661-40 - 41662-50  
 and  
 Aproximators  
 41667-30 - 41670-50  
 and  
 41672-01 - 41672-04

**HADEO**  
INSTRUMENTE GERMANY

Gefäßclips nach MEHDORN  
MEHDORN Vessel Clips  
Clips para vasos de MEHDORN  
Clips secondo MEHDORN

für temporären Gebrauch

gekennzeichnet durch gelb eingefärbte Federenden für Gefäße mit einem Durchmesser 0,5 - 1,5 mm

Maulinnenflächen schräg gerieft für schonendes, sicheres Festhalten der Gefäße

Der fest eingestellte Schließdruck gewährt risikofreie Anwendung

for temporary occlusion

(identified by yellow coloured spring ends) for vessel diam. 0,5 - 1,5 mm

Blade gripping surface with oblique serrations for save but careful gripping of vessels

No risk due to rigidly fixed pressure measure

para uso temporal

clips marcados con baño dorado en los resortes, para vasos con un diámetro de 0.5 - 1.5 mm

El interior de las quijadas viene con estrias finas para un agarre seguro y cuidadoso de los vasos

Debido a la calibración exacta de la fuerza de cierre se ofrece una aplicación sin riesgo

per chiusura temporanea

per vasi con Diametro 0,5 - 1,5 mm

La chiusura regolata garantisce nessun rischio



Beispiele für die variable Position des Clips  
Ejemplo para la variedad de la aplicación del clip  
Esempio: posizioni variabili delle clips

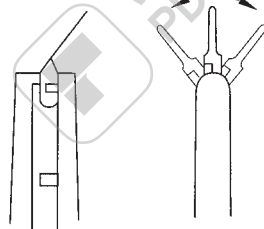

		Maullänge Length of jaws Largo de la boca Lunghezza del morso	Schließkraft Closing Force Fuerza del cierre Forza di chiusura	MEHDORN 41666-00
	41664-10	4 x 1,0 mm	10 - 15 g (0,10 - 0,15 N)	Anlegepinzette für Mikro-Gefäßclips 41664-10 - 41665-14
	41664-14	4 x 1,4 mm	15 - 20 g (0,15 - 0,20 N)	Applying Forceps for vessel clips 41664-10 - 41665-14
	41665-10	6 x 1,0 mm	10 - 15 g (0,10 - 0,15 N)	Pinza applicadora para micro-vasos 41664-10 - 41665-14
	41665-14	6 x 1,4 mm	15 - 20 g (0,15 - 0,20 N)	Pinza posa clips per microvasi 41664-10 - 41665-14



**Approximatoren nach Biemer-Müller**  
**Approximators Biemer-Müller**  
**Aproximadores de Biemer-Müller**  
**Approssimatore secondo Biemer-Müller**

**für temporären Gebrauch**

gekennzeichnet durch gelb eingefärbte Federenden für Gefäße mit einem Durchmesser 0,5 - 2,0 mm  
 Maulinnenflächen schräg gerieft für schonendes, sicheres Festhalten der Gefäße  
 Der fest eingestellte Schließdruck gewährt risikofreie Anwendung

**for temporary occlusion**

(identified by yellow coloured spring ends) for vessel diam. 0,5 - 2,0 mm  
 Blade gripping surface with oblique serrations for save but careful gripping of vessels  
 No risk due to rigidly fixed pressure measure

**para uso temporal**

clips marcados con baño dorado en los resortes, para vasos con un diámetro de 0,5 - 2,0 mm  
 El interior de las quijadas viene con estrias finas para un agarre seguro y cuidadoso de los vasos  
 Debido a la calibración exacta de la fuerza de cierre se ofrece una aplicación sin riesgo

**per chiusura temporanea**

per vasi con Diametro 0,5 - 2,0 mm  
 La chiusura regolata garantisce nessun rischio

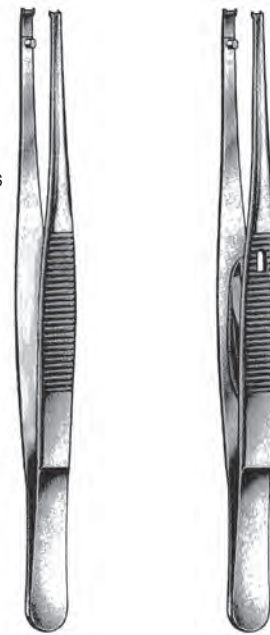

	Maulöffnung Opening	Maullänge Length of jaws	Schließkraft Closing Force
	Apertura de la boca	Largo de la boca	Fuerza del cierre
	Apertura del morso	Lunghezza del morso	Forza di chiusura
	3,0 mm	4,5 mm	30 - 40 g (0,29 - 0,39 N)
	5,0 mm	9,0 mm	30 - 40 g (0,29 - 0,39 N)
	5,0 mm	9,0 mm	30 - 40 g (0,20 - 0,25 N)
	5,0 mm	9,0 mm	30 - 40 g (0,20 - 0,25 N)
	5,0 mm	9,0 mm	30 - 40 g (0,20 - 0,25 N)

BIEMER 41663-01	BIEMER 41663-02
Anlegepinzette ohne Schloß, für Mikro-Gefäßclips 41661-40 - 41662-50 und Approximatoren 41667-30 - 41670-50 und 41672-01 - 41672-04	Anlegepinzette mit Schloß, für Mikro-Gefäßclips 41661-40 - 41662-50 und Approximatoren 41667-30 - 41670-50 und 41672-01 - 41672-04
Applying forceps without lock. for vessel clips 41661-40 - 41662-50 and Aproximators 41667-30 - 41670-50 and 41672-01 - 41672-04	Applying forceps with lock. for vessel clips 41661-40 - 41662-50 and Aproximators 41667-30 - 41670-50 and 41672-01 - 41672-04



Approximatoren nach Müller  
 Müller Approximators  
 Aproximadores de Müller  
 Approssimatore secondo Müller

**für temporären Gebrauch**

gekennzeichnet durch gelb eingefärbte Federenden für Gefäße mit einem Durchmesser 0,5 - 2,0 mm  
 Maulinnenflächen schräg gerieft für schonendes, sicheres Festhalten der Gefäße  
 Der fest eingestellte Schließdruck gewährt risikofreie Anwendung

**for temporary occlusion**

(identified by yellow coloured spring ends) for vessel diam. 0,5 - 2,0 mm  
 Blade gripping surface with oblique serrations for save but careful gripping of vessels  
 No risk due to rigidly fixed pressure measure

**para uso temporal**

clips marcados con baño dorado en los resortes, para vasos con un diámetro de 0,5 - 2,0 mm  
 El interior de las quijadas viene con estrias finas para un agarre seguro y cuidadoso de los vasos  
 Debido a la calibración exacta de la fuerza de cierre se ofrece una aplicación sin riesgo

**per chiusura temporanea**

per vasi con Diametro 0,5 - 2,0 mm  
 La chiusura regolata garantisce nessun rischio

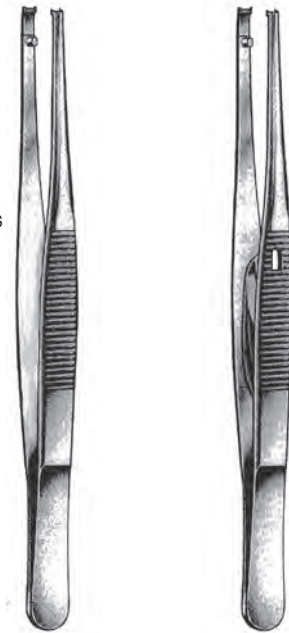

	Ø Diameter	Schließkraft Closing Force Fuerza del cierre Forza di chiusura	BIEMER 41663-01	BIEMER 41663-02
	1,0 mm	25 - 30 g (0,25 - 0,29 N)	Anlegepinzette ohne Schloß, für Mikro-Gefäßclips 41661-40 - 41662-50 und Approximatoren 41667-30 - 41670-50 und 41672-01 - 41672-04	Anlegepinzette mit Schloß, für Mikro-Gefäßclips 41661-40 - 41662-50 und Approximatoren 41667-30 - 41670-50 und 41672-01 - 41672-04
	2,0 mm	25 - 30 g (0,25 - 0,29 N)	Applying forceps without lock. for vessel clips 41661-40 - 41662-50 and Aproximators 41667-30 - 41670-50 and 41672-01 - 41672-04	Applying forceps with lock. for vessel clips 41661-40 - 41662-50 and Aproximators 41667-30 - 41670-50 and 41672-01 - 41672-04
	3,0 mm	25 - 30 g (0,25 - 0,29 N)		
	4,0 mm	25 - 30 g (0,25 - 0,29 N)		

**HADEO**  
 INSTRUMENTE GERMANY

Gefäßclips nach Müller  
 Müller Vessel Clips  
 Clips para vasos de Müller  
 Clip secondo Müller

**für temporären Gebrauch**

Maulinnenflächen pyramidenförmig  
 für schonendes, sicheres Festhalten  
 der Gefäße

Der fest eingestellte Schließdruck  
 gewährt risikofreie Anwendung

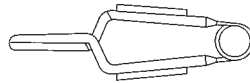

41674-50 50 g

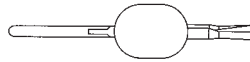

41674-80 80 g

**for temporary occlusion**

Blade gripping surface with pyramid-  
 like impressions for safe but careful  
 gripping of vessels

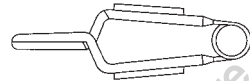

41675-50 50 g

No risk due to rigidly fixed pressure  
 measure



41675-80 80 g

**para uso temporal**

El interior de las quijadas viene en  
 forma de pirámide para un agarre  
 seguro y cuidadoso de los vasos.



41676-50 50 g



41676-80 80 g

Debido a la calibración exacta de  
 la fuerza de cierre se ofrece una  
 aplicación sin riesgo.



41677-50 50 g

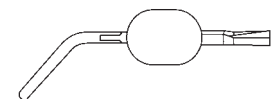

41677-80 80 g

**per uso temporaneo**

Morso interno con forma piramidale  
 per garantire una chiusura sicura del  
 vaso

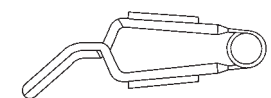

41678-50 50 g



41678-80 80 g

Schließkraft  
 Closing Force  
 Fuerza del cierre  
 Forza di chiusura

**HADEO**  
 INSTRUMENTE GERMANY

Approximator nach Biemer  
 Biemer Approximator  
 Aproximadores de Biemer  
 Approssimatore secondo Biemer

#### für Mikro-Gefäßanastomosen im oberflächlichem Bereich

Maulinnenflächen schräg gerieft für schonendes, sicheres Festhalten der Gefäße

Der fest eingestellte Schließdruck gewährt risikofreie Anwendung

Der Abstand zwischen den Clips ist durch einfaches Verschieben einzustellen und wird durch Verkanten fixiert

#### for micro vessel anastomosis in the superficial range

Blade gripping surface with oblique serrations for save but careful gripping of vessels

No risk due to rigidly fixed pressure measure

Adjustable distance between the clips and automatic fixation by tilting

#### para micro-anastomosis en la superficie

El interior de la quijada viene con estrias finas para un agarre seguro y cuidadoso de los vasos.

Debido a la calibración exacta de la fuerza de cierre se ofrece una aplicación sin riesgo.

El espacio entre los clips se logra fácilmente por el desplazamiento.

#### per micro vasi anastomosi sulla parte della superficie

Parte interna del morso è leggermente striata obliqua per ottenere la presa sulla superficie del vaso.

La chiusura regolata garantisce nessun rischio.

Lo scorrimento delle due clips viene regolato con semplice movimento che consente una chiusura ottimale.



BIEMER  
41680-00

Anlegepinzette für  
Gefäß-Approximator  
nach BIEMER

Applying forceps for  
BIEMER vessel  
approximator

Pinza aplicadora  
para aproximadores  
de BIEMER

Pinza posa clips per  
vasi approssimatori  
secondo BIEMER

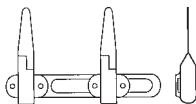

41679-25 25 - 30 g  
(0,25 - 0,29 N)

Schließkraft  
Closing Force  
Fuerza de cierre  
Forza di chiusura



**HADEO**  
INSTRUMENTE GERMANY

Mikro-Gefäßclips  
Micro Vessel Clips  
Micro Clips vasculares  
Micro Clips vascolari



BIEMER  
41679-00

Nerv-Approximator komplett mit Schlüssel 41690-01  
Approximator for nerves complete with key 41690-01  
Aproximador para nervios, completo con llave 41690-01  
Approssimatore per nervi completo di chiave 41690-01

41679-01  
Nadeln allein (Paar)  
Needle only (pair)  
Agujas sueltas (par)  
Aghi soli (paio)



BIEMER  
41690-00

Approximator mit einstellbarem Clip-Abstand und Druck,  
komplett mit Schlüssel 41690-01

Approximator with adjustable clip distance and pressure,  
complete with key 41690-01

Aproximador con distancia de clip y presión ajustable,  
completo con llave 41690-01

Approssimatore con distanza per clip e pressione regolabile,  
completo di chiave 41690-01



41690-01  
Ersatzschlüssel  
für Approximator 41679-00 + 41690-00  
Replacement key  
for approximator 41679-00 + 41690-00  
Llave de repuesto  
para el aproximador 41679-00 + 41690-00  
Chiave di ricambio  
per approssimatore 41679-00 + 41690-00



**HADEO**  
 INSTRUMENTE GERMANY

Sterilisations- und Lagerungscontainer  
 Sterilisation and Utility Tray Storage  
 Contenedor para esterilizacion y almacenaje  
 Container dotato di alloggi interni per la conservazione e la sterilizzazione degli strumenti

41700-01  
 528 x 254 x 40 mm

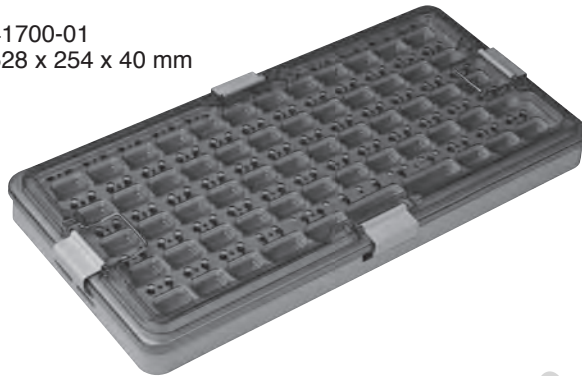

Clip Lagertray für 58 Y-Aneurysmenclips,  
 Kunststoff, dampfsterilisierbar bis 3 bar  
 (143° C / 289° F)

Storage tray for 58 Y-Aneurysm-Clips, with lid  
 made out of PPSU

Cesta de plástico para almacenaje de  
 58 Y-clips de aneurisma

Contenitore di plastica con 58 alloggi per clip  
 per aneurisma. Resistente in autoclave fino a  
 3 bar (143° C / 289° F)

41700-02  
 528 x 254 x 40 mm

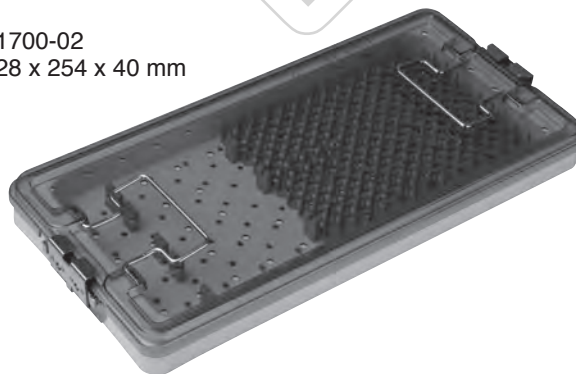

Lagertray für Clipanlegezangen und Instru-  
 mente, Kunststoff, dampfsterilisierbar bis  
 3 bar (143° C / 289° F).

Storage tray for clip applicators and instru-  
 ments, stacking system, made out of PPSU, for steam  
 sterilisation up to 3 bar (143° C / 289° F)

Cesta de plástico para almacenaje de pinzas  
 aplicadoras y instrumentos, para esteriliza-  
 cion de vapor hasta 3 bar (143° C / 289° F).

Contenitore di plastica per pinza applicatore  
 clips e strumentario. Resistente in autoclave  
 3 bar (143° C / 289° F)

**HADEO**  
INSTRUMENTE GERMANY

Sterilisations- und Lagerungscontainer  
Sterilisation and Utility Tray Storage  
Contenedor para esterilizacion y almacenaje  
Container dotato di alloggi interni per la conservazione e la sterilizzazione degli strumenti

41700-03  
528 x 254 x 40 mm

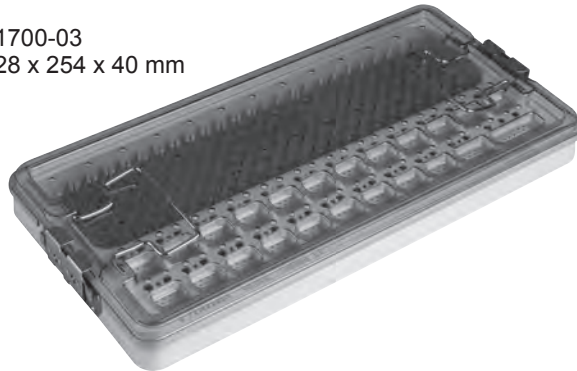

Lagertray für 23 Y-Aneurysmenclips und Clip-  
anlegezangen Kunststoff mit Deckel, dampf-  
sterilisierbar bis 3 bar (143° C / 289° F)

Storage tray for 23 Y-Aneurysmen-Clips and  
clip appliers, stacking system, with lid made  
out of PPSU, for steam sterilisation up to 3 bar  
(143° C / 289° F)

Cesta de plastico con tapa para almacenaje de  
23 Y-clips de aneurisma y pinzas aplicadoraas,  
para esterilizacion de vapor hasta 3 bar  
(143° C / 289° F)

Contenitore di plastica dotato di alloggio per  
23 clips per aneurisma e pinza posa clips con  
coperchio. Resistente in autovlave 3 bar  
(143° C / 289° F)



41700-04  
150 x 95 x 13 mm

mit 18 Vertiefungen  
space for 18 Clips  
con espacio para 18 clips  
con cavita per 18 clips



41700-05  
210 x 125 x 17 mm

mit 42 Vertiefungen  
space for 42 Clips  
con espacio para 42 clips  
con cavita per 42 clips

**HADEO**  
INSTRUMENTE GERMANY

“Neue Form” NS  
“New S tyle” NS  
“Nueva Forma” NS  
“Nuove Forme” NS

ACLAND Mikro-Gefäßclips  
ACLAND Micro Vessel Clips  
ACLAND Micro Clips vasculares  
ACLAND Micro Clips vascolari

Einzelklemmen  
Single Clamps  
Single clamp  
Pinza singola



A		V	
41710-08	8 mm	41711-08	
41710-11	11 mm	41711-11	
41710-17	17 mm	41711-17	



A		V	
41718-25	25 mm	41719-25	
41718-36	36 mm	41719-36	

Doppelklemme mit Rahmen  
Double Clamps with frame  
Clamp doble con marco  
Pinza doppia con telaio

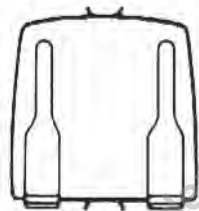

A		V	
41714-08	8 mm	41715-08	
41714-11	11 mm	41715-11	
41714-17	17 mm	41715-17	

Approximator ohne Rahmen  
Approximator without frame  
Aproximador sin marco  
Apressimatore senza telaio

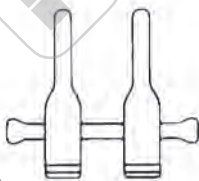

A		V	
41712-08	8 mm	41713-08	
41712-11	11 mm	41713-11	
41712-17	17 mm	41713-17	

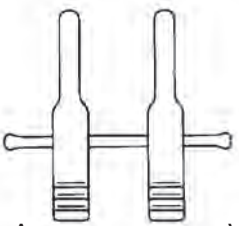

A		V	
41720-25	25 mm	41721-25	
41720-36	36 mm	41721-36	

Approximator mit Rahmen  
Approximator with frame  
Aproximador con marco  
Apressimatore con telaio

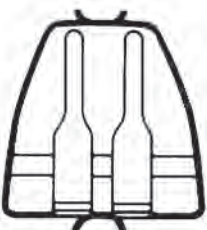

A		V	
41716-08	8 mm	41717-08	
41716-11	11 mm	41717-11	
41716-17	17 mm	41717-17	

A = Arterie/Artery  
CURVED JAW



V = Vene/Vein  
STRAIGHT JAW



**HADEO**  
 INSTRUMENTE GERMANY

ACLAND Mikro-Gefäßclips  
 ACLAND Micro Vessel Clips  
 ACLAND Micro Clips vasculares  
 ACLAND Micro Clips vascolari

“Alte Form” OS  
 “Classic Style” OS  
 “Forma antigua” OS  
 “Vecchia tipologia” OS

Einzelklemmen  
 Single Clamps  
 Single clamp  
 Pinza singola

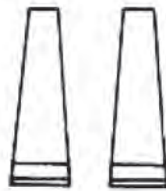

A		V
41722-08	8 mm	41723-08
41722-11	11 mm	41723-11
41722-14	14 mm	41723-14
41722-17	17 mm	41723-17
41722-23	23 mm	41723-23

Doppelklemme mit Rahmen  
 Double Clamps with frame  
 Clamp doble con marco  
 Pinza doppia con telaio



A		V
41726-08	8 mm	41727-08
41726-11	11 mm	41727-11
41726-14	14 mm	41727-14
41726-17	17 mm	41727-17
41726-23	23 mm	41727-23

A = Arterie/Artery  
 CURVED JAW



V = Vene/Vein  
 STRAIGHT JAW





“Alte Form” OS  
 “Classic Style” OS  
 “Forma antigua” OS  
 “Vecchia tipologia” OS

ACLAND Mikro-Gefäßclips  
 ACLAND Micro Vessel Clips  
 ACLAND Micro Clips vasculares  
 ACLAND Micro Clips vascolari

Approximator ohne Rahmen  
 Approximator without frame  
 Aproximador sin marco  
 Approssimatore senza telaio

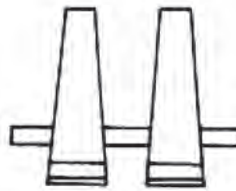

	A	V
41724-08	8 mm	41725-08
41724-11	11 mm	41725-11
41724-14	14 mm	41725-14
41724-17	17 mm	41725-17
41724-23	23 mm	41725-23

Approximator mit Rahmen  
 Approximator with frame  
 Aproximador con marco  
 Approssimatore con telaio



	A	V
41728-08	8 mm	41729-08
41728-11	11 mm	41729-11
41728-14	14 mm	41729-14
41728-17	17 mm	41729-17
41728-23	23 mm	41729-23

A = Arterie/Artery  
 CURVED JAW



V = Vene/Vein  
 STRAIGHT JAW



**HADEO**  
INSTRUMENTE GERMANY

Clip-Anlegepinzetten für ACLAND-Clips  
Clip Applying Forceps for ACLAND clips  
Pinzas aplicadora para clips ACLAND  
Pinze per applicare clips di ACLAND

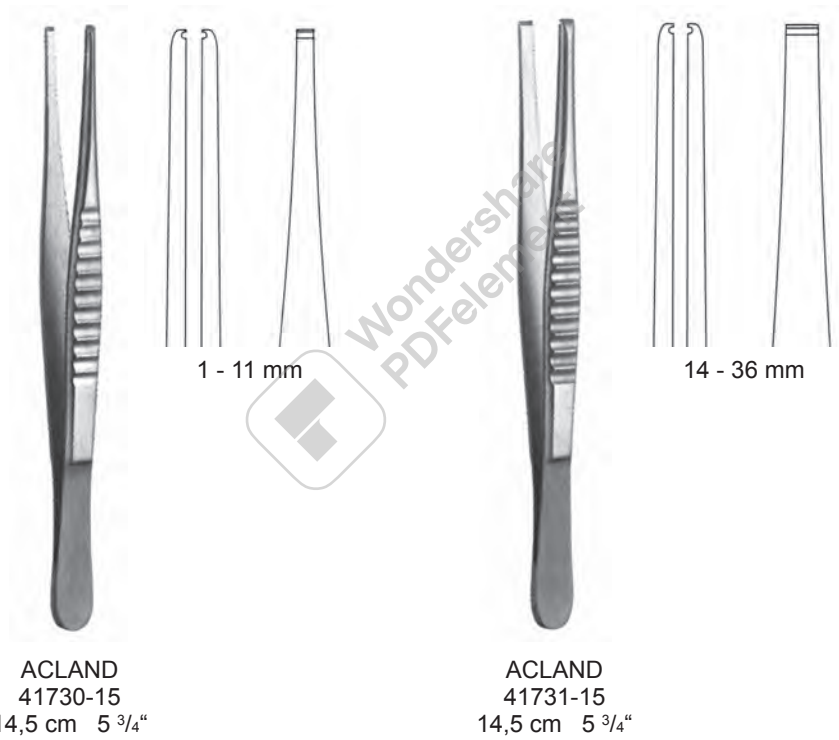

**HADEO**  
 INSTRUMENTE GERMANY

Clipanlagezangen für die offene Chirurgie 25° aufgebogen  
 Clip Appliers for open Surgery 25° upcurved  
 Pinza aplicadora de clips para cirugía abierta con ángulo de 25°  
 Pinza applicatore clips per chirurgia aperta, curva in alto 25°



15 cm, 6"

**Horizon**

61460-15 Small gelb / yellow / jaune/ amarillo/ giallo  
 61461-15 Medium blau / blue / bleu / azul / blu

**SLS Clips**

61464-15 Micro weiss / white / blanc / blanco / bianco  
 61465-15 Small gelb / yellow / jaune/ amarillo/ giallo  
 61466-15 Small medium lila / lilac / lilas / lila / lilla  
 61467-15 Medium blau / blue / bleu / azul / blu

**Ethicon**

61470-15 Small blau / blue / bleu / azul / blu  
 61471-15 Medium weiss / white / blanc / blanco / bianco

**Pilling**

61481-15 Small gelb / yellow / jaune / amarillo / giallo  
 61482-15 Medium blau / blue / bleu / azul / blu

**Horizon**

61460-19 Small gelb / yellow / jaune / amarillo / giallo  
 61461-19 Medium blau / blue / bleu / azul / blu  
 61462-19 Medium Large grün / green / verde / verde  
 61463-19 Large orange / naranja / arancione

**SLS Clips**

61464-19 Micro weiss / white / blanc / blanco / bianco  
 61465-19 Small gelb / yellow/ jaune / amarillo / giallo  
 61466-19 Small medium lila / lilac / lilas / lila / lilla  
 61467-19 Medium blau / blue / bleu / azul / blu  
 61468-19 Medium Large grün / green / verde / verde  
 61469-19 Large orange / naranja / arancione

**Ethicon**

61470-19 Small blau / blue / bleu / azul / blu  
 61471-19 Medium weiss / white / blanc / blanco / bianco  
 61472-19 Medium Large grün / green / verde / verde  
 61473-19 Large gelb / yellow / jaune / amarillo / giallo

**Pilling**

61481-19 Small gelb / yellow / jaune / amarillo / giallo  
 61482-19 Medium blau / blue / bleu / azul / blu  
 61484-19 Medium Large grün / green / verde / verde  
 61483-19 Large orange / naranja / arancione



19 cm, 7 1/2"

**HADEO**  
INSTRUMENTE GERMANY

Clipanlegezangen für die offene Chirurgie 25° aufgebogen  
Clip Appliers for open Surgery 25° upcurved  
Pinza aplicadora de clips para cirugía abierta con ángulo de 25°  
Pinza applicatore clips per chirurgia aperta, curva in alto 25°

**Horizon**

61461-28 Medium blau / blue / bleu / azul / blu  
61462-28 Medium Large grün / green / verde / verde  
61463-28 Large orange / naranja / arancione

**SLS Clips**

61464-28 Micro weiss / white / blanco / bianco  
61465-28 Small gelb / yellow / jaune / amarillo / giallo  
61466-28 Small medium lila / lilac / lilas / lila / lilla  
61467-28 Medium blau / blue / bleu / azul / blu  
61468-28 Medium Large grün / green / verde / verde  
61469-28 Large orange / naranja / arancione

**Ethicon**

61471-28 Medium weiss / white / blanco / bianco  
61472-28 Medium Large grün / green / verde / verde  
61473-28 Large gelb / yellow / jaune / amarillo / giallo

**Pilling**

61482-28 Medium blau / blue / bleu / azul / blu  
61484-28 Medium Large grün / green / verde / verde  
61483-28 Large orange / naranja / arancione



28 cm, 11"



BOHRAPPARATE

BONE HAND DRILLS

PERFORADORES DE MANO

PERFORATORI A MANO

**HADEO**  
INSTRUMENTE GERMANY

[www.hadeo.co](http://www.hadeo.co)

Wondershare  
PDFelement

**HADEO**  
INSTRUMENTE GERMANY

Bohrapparate  
Bone Hand Drills  
Perforadores de mano  
Perforatori a mano

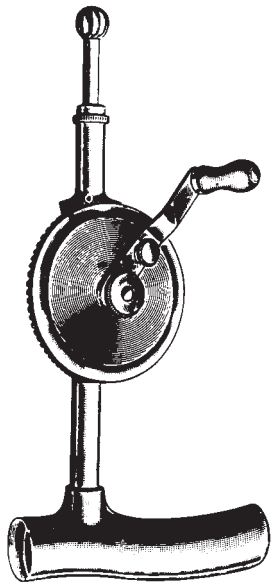

**STILLE**  
34210-20 20 cm, 8"  
compl. incl. 34212-25 - 34214-16



34212-25  
2,5 mm



34212-30  
3,0 mm



34212-35  
3,5 mm



34212-40  
4,0 mm



34214-05  
10 mm



34214-08  
5 mm



34214-10  
8 mm



34214-12  
12 mm

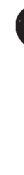

34214-16  
16 mm



34216-10  
1,0 mm



34216-15  
1,5 mm



34216-20  
2,0 mm

**HADEO**  
INSTRUMENTE GERMANY

Bohrapparate  
Bone Hand Drills  
Perforadores de mano  
Perforatori a mano



34222-25 2,5 mm  
34222-30 3,0 mm  
34222-35 3,5 mm

**STILLE-SHERMAN**  
34220-24 24 cm, 9 1/2"  
compl. incl. 34222-25 - 34222-35



34232-00

**MOORE**  
34230-28 28 cm, 11"  
compl. incl. 34232-00

**HADEO**  
INSTRUMENTE GERMANY

Bohrapparate  
Bone Hand Drills  
Perforadores de mano  
Perforatori a mano



34241-00  
Griff allein  
Handle only  
Mango solo

HUDSON  
34240-27  
27 cm, 10 1/2"  
compl. incl.  
34242-09, -14, -16, -22,  
34246-00



34242-09  
9 mm



34242-14  
14 mm



34242-16  
16 mm



34242-22  
22 mm



34246-00

Verlängerungsstück  
Extension piece  
Pieza alargadera  
Giunto di prolungamento



ø 2 mm  
34243-02



CUSHING  
34244-10  
34244-14  
34244-16



ERRICO  
34244-17  
ø 16 mm



MC KENZIE  
34248-00  
ø 13 mm

**HADEO**  
 INSTRUMENTE GERMANY

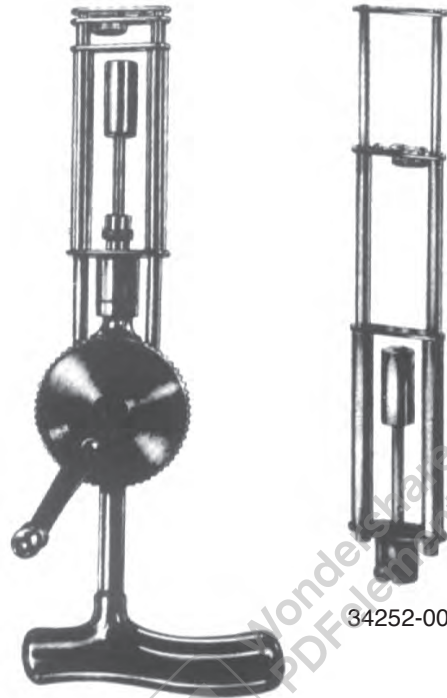
 Bohrrapparate  
 Bone Hand Drills  
 Perforadores de mano  
 Perforatori a mano

34252-00

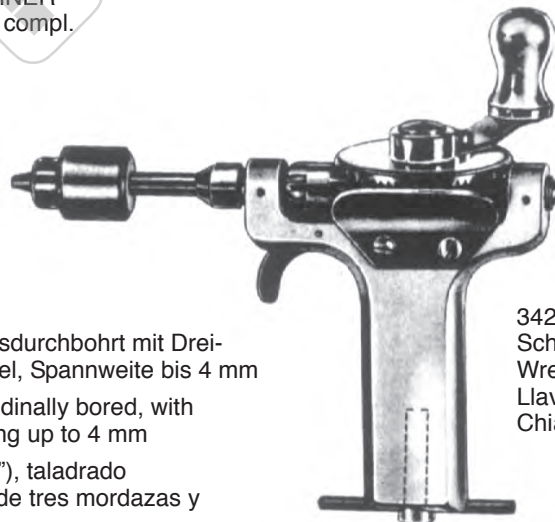
 KIRSCHNER  
 34250-00 compl.

 34270-01  
 Schlüssel  
 Wrench  
 Llave  
 Chiave

 Bohrrapparat 16 cm (6 1/4"), längsdurchbohrt mit Drei-  
 backenspannfutter und Schlüssel, Spannweite bis 4 mm

 Hand drill, 16 cm (6 1/4"), longitudinally bored, with  
 three-jaw-chuck and key, opening up to 4 mm

 Perforador manual, 16 cm (6 1/4"), taladrado  
 longitudinalmente, con mandril de tres mordazas y  
 llave, apertura hasta 4 mm

 Perforatore a mano, 16 cm (6 1/4"), con perforazione  
 assiale, con mandrino a tre ganasce e chiave, apertura  
 fino a 4 mm di D.

 BUNELL  
 34270-00  
 16 cm, 6 1/4"

# HADEO

INSTRUMENTE GERMANY

Bohrapparate  
Bone Hand Drills  
Perforadores de mano  
Perforatori a mano



RALK  
34280-00

Bohrapparat mit Leichtmetallgehäuse,  
mit Dreibackenspannfutter und  
Schlüssel, Spannweite bis D. 6,35 mm

Hand drill with light metal case, with  
three-jaw-chuck and key, opening up to  
D. 6,35 mm

Perforador manual con caja de metal  
ligero, con mandril de tres mordazas y  
llave, apertura hasta Ø 6,35 mm

Perforatore a mano con cassa in metallo  
leggero, con mandrino a tre ganasce e  
chiave, apertura fino a 6,35 mm di D.



HADEO  
34290-00

Handbohrapparat mit umstellbarem  
Handgriff, mit Jacobs Dreibackenspann-  
futter und Schlüssel

Hand drill with adjustable handle, with  
Jacobs three-jaw-chuck and wrench

Perforador manual con mango ajustable,  
con mandril Jacobs de 3 mordazas y  
llave

Perforatore a mano con manico regola-  
bile, con mandrino Jacobs a tre ganasce  
complete con chiave



34295-00  
Spannschlüssel allein  
Key only  
Llave sola  
Chiave solo



BIPOLEARE KOAGULA TION

BIPOLAR COAGULA TION

COAGULACIÓN BIPOLAR

COAGULAZIONE BIPOLARE



[www.hadeo.co](http://www.hadeo.co)

**HADEO**  
INSTRUMENTE GERMANY

Bipolare Koagulation  
Bipolar Coagulation  
Coagulación bipolar  
Coagulazione bipolare



91104-11  
11 cm, 4  $\frac{3}{8}$ "  
0,5 mm



91109-11  
11 cm, 4  $\frac{3}{8}$ "  
45°, 0,5 mm



91113-11  
11 cm, 4  $\frac{3}{8}$ "  
45°, 0,5 mm



91122-16  
16,5 cm, 6  $\frac{1}{2}$ "  
0,5 mm



91123-16  
16,5 cm, 6  $\frac{1}{2}$ "  
0,5 mm



91125-16  
16,5 cm, 6  $\frac{1}{2}$ "  
0,5 mm



**HADEO**  
INSTRUMENTE GERMANY

Bipolare Koagulation  
Bipolar Coagulation  
Coagulación bipolar  
Coagulazione bipolare



91142-16  
16 cm, 6 1/4"  
1 mm



91144-16  
16,5 cm, 6 1/2"  
0,5 mm



91152-19  
19,5 cm, 7 3/4"  
0,3 mm



91154-19  
19,5 cm, 7 3/4"  
1 mm



91157-19  
19,5 cm, 7 3/4"  
1 mm



91159-19  
19,5 cm, 7 3/4"  
2 mm

**HADEO**  
INSTRUMENTE GERMANY

Bipolare Koagulation  
Bipolar Coagulation  
Coagulación bipolar  
Coagulazione bipolare



91162-19  
19,5 cm, 7 3/4"  
0,3 mm



91164-19  
19,5 cm, 7 3/4"  
1 mm

**HADEO**  
INSTRUMENTE GERMANY

Bipolare Koagulation  
Bipolar Coagulation  
Coagulación bipolar  
Coagulazione bipolare



91166-19  
19,5 cm, 7 <sup>3</sup>/<sub>4</sub>"  
2 mm



91172-03 - 91172-12  
22,5 cm, 8.9"

91172-03  
0,3 mm

91172-07  
0,7 mm

91172-12  
1,2 mm

Wondershare  
PDFelement

**HADEO**  
 INSTRUMENTE GERMANY

 Bipolare Koagulation  
 Bipolar Coagulation  
 Coagulación bipolar  
 Coagulazione bipolare

**NON STICK**

 gerade  
 straight  
 recta  
 retta

	0,3 mm	0,5 mm	1,0 mm	2,0 mm
11,0 cm, 4 3/8"	91110-03N	91110-05N	91110-10N	
16,0 cm, 6 1/4"	91160-03N	91160-05N	91160-10N	91160-20N
18,0 cm, 7"		91180-05N	91180-10N	91180-20N
19,5 cm, 7 3/4"		91200-05N	91200-10N	91200-20N
22,0 cm, 8 3/4"			91220-10N	91220-20N
24,0 cm, 9 1/2"			91240-10N	
30,0 cm, 12"			91300-10N	91300-20N

 abgewinkelt 45°  
 angled 45°  
 angulada 45°  
 angolata 45°

	0,3 mm	0,5 mm	1,0 mm	2,0 mm
11,0 cm, 4 3/8"	91112-03N	91112-05N	91112-10N	
16,0 cm, 6 1/4"		91162-05N	91162-10N	
18,0 cm, 7"			91182-10N	91182-20N
19,5 cm, 7 3/4"		91202-05N	91202-10N	91202-20N
22,0 cm, 8 3/4"			91222-10N	91222-20N
24,0 cm, 9 1/2"			91242-10N	
30,0 cm, 12"			91302-10N	

**HADEO**  
INSTRUMENTE GERMANY

**NON STICK**

Bipolare Koagulation  
Bipolar Coagulation  
Coagulación bipolar  
Coagulazione bipolare

bayonett gerade  
bajonett straight  
bayoneta recta  
baionetta retta



	0,3 mm	0,5 mm	1,0 mm	2,0 mm
16,0 cm, 6 1/4"	91166-03N	91166-05N	91166-10N	91166-20N
19,5 cm, 7 3/4"		91206-05N	91206-10N	91206-20N
22,0 cm, 8 3/4"		91226-05N	91226-10N	91226-20N
24,0 cm, 9 1/2"		91246-05N	91246-10N	91246-20N

bayonett nach oben  
bajonett upwards  
bayoneta hacia arriba  
baionetta in alto



	1,0 mm
19,5 cm, 7 3/4"	91207-10N
22,0 cm, 8 3/4"	91227-10N

bayonett nach unten  
bajonett downwards  
bayoneta hacia abajo  
baionetta in basso



	0,5 mm	1,0 mm
16,0 cm, 6 1/4"	91168-05N	91168-10N
19,5 cm, 7 3/4"		91208-10N
22,0 cm, 8 3/4"		91228-10N

**HADEO**  
INSTRUMENTE GERMANY

Bipolare Saugpinzetten  
Bipolar suction Forceps  
Pinza de succión bipolar  
Pinza bipolare con canale di aspirazione

Saugpinzetten zum Absaugen von Blut und Sekret vor der Koagulation bzw. zum Absaugen von Rauch während der Koagulation.

Europäischer Flachstecker zum Anschluß von bipolaren Kabeln für praktisch alle gebräuchlichen HF-Generatoren.

Der Saugkanal mit Unterbrecherloch ist in einem Schenkel der Pinzette integriert.

An der Schlaucholive können verschiedene Schlauchdurchmesser angeschlossen werden.

Suction forceps for extraction of blood and debris by suction right before coagulation or extraction of smoke while coagulating.

European flat socket connector for bipolar cables for nearly all common high frequency generators.

Suction channel embedded inside the forceps.

Suction connector matches different suction tube diameters.



Pinza de succión para sangre y líquidos antes de efectuar la coagulación como también para la eliminación de humo durante la coagulación. Enchufe plano europeo para conectar cables bipolares de equipos de alta frecuencia en uso corrientemente.

El canal de succión con su agujero de interrupción está incorporado en un lado de la pinza.

El diseño de la oliva de conexión permite la adaptación de tubos de varios diámetros.

Pinza bipolare dotata di canale di aspirazione. Per aspirare fumi, sangue ecc. durante la coagulazione. Attacco piatto per cavi bipolari con attacchi europei.

Il canale di aspirazione con interruzione é integrato sulla aletta della pinza.

Ingresso del canale di aspirazione ad oliva che permette attacchi di diversi diametri.

**HADEO**  
 INSTRUMENTE GERMANY

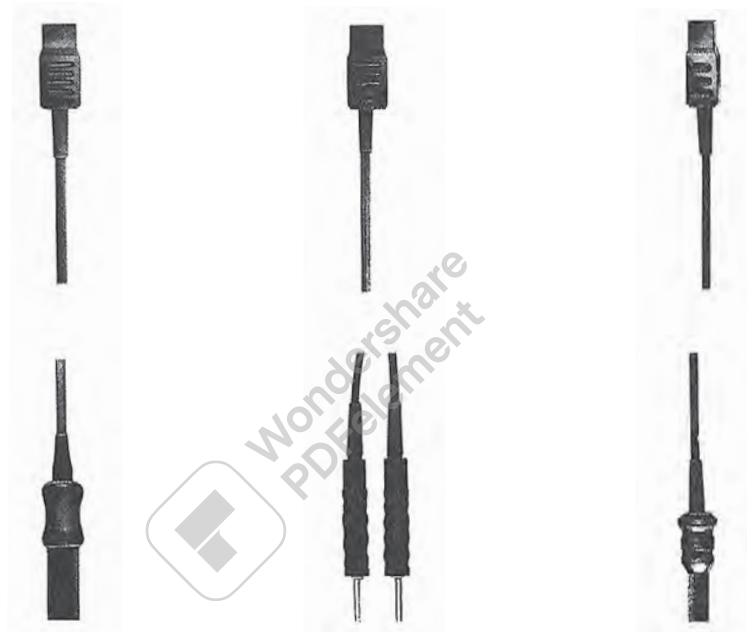
 Verbindungskabel, bipolar  
 Connection Cords, bipolar  
 Cables de conexión, bipolar  
 Cavi da connessione, bipolare

		<b>ERBE SELECT STORZ</b>
3 m	118"	91190-30
5 m	197"	91190-50

**USA Mod.**

91192-30
91192-50

<b>MARTIN BERCHTOLD AESCULAP</b>
91193-30
91193-50

für Elektro-Chirurgie-Einheiten  
 for Electrosurgery Equipment  
 para Electrobisturios  
 per Elettrobisturi





SÄTZE

SET

SET

SET

Wondershare PDFelement



[www.hadeo.co](http://www.hadeo.co)

**Set / 200 Basic Set for Neurosurgery - Neurochirurgie Set**

1x	07103-00	scalpel handle no. 3
1x	07107-00	scalpel handle no. 7
1x	07104-00	scalpel handle no. 4
1x	09160-17	MAYO, dissecting scissors, str., 17cm
1x	09161-17	MAYO, dissecting scissors, cvd., 17cm
1x	09280-18	METZENBAUM, dissecting scissors, str., 18cm
1x	11112-18	POTTS-SMITH, dressing forceps, 18cm
1x	11126-18	POTTS-SMITH, tissue forceps, 1x2 teeth, 18cm
1x	11189-15	BROWN, tissue forceps, 9x9 teeth, 15cm
1x	11315-01	TAYLOR, dressing forceps, bayonet, 17cm
1x	11315-02	TAYLOR, tissue forceps, 1x2 teeth, bayonet, 17cm
1x	41295-10	FRAZIER/FERGUSSON, suction tube, 30°, 19cm
2x	25214-18	DeBAKEY, needle holder TC, 18cm
2x	25225-18	RYDER, needle holder TC, 18cm
10x	13220-12	HALSTED-MOSQUITO, hemostatic forceps, str., 12,5cm
6x	13345-14	DANDY, hemostatic forceps, cvd., 14cm
6x	13320-14	ROCHESTER-OCHSNER, hemostatic forceps, 1x2 teeth, str., 14cm
10x	15111-09	BACKHAUS, towel forceps, 9cm
2x	17170-18	FOERSTER, swab forceps, str., 18cm
1x	19214-13	FRAZIER, nerve hooklet, 13cm
1x	19168-06	RIBBON, retractor, 6x200mm
1x	19168-12	RIBBON, retractor, 12x200mm
1x	19168-17	RIBBON, retractor, 17x200mm
1x	19168-25	RIBBON, retractor, 25x200mm
2x	19670-16	WEITLANER, retractor, 16,5cm
2x	19684-16	ADSON-BABY, retractor, 16cm
1x	33711-20	LANGENBECK, periosteal elevator, 20cm
1x	33142-20	ADSON, bone rongeur, str., 20cm
1x	33247-23	LEKSELL-STILLE, bone rongeur, 23cm / 4mm
1x	33245-23	LEKSELL-STILLE, bone rongeur, 23cm / 7mm
6x	65120-15	ALLIS, tissue forceps, 5x6 teeth, 15cm
1x	41512-02	FERRIS-SMITH-KERRISON, rongeur, 45° up, 2mm, 18cm
1x	41512-03	FERRIS-SMITH-KERRISON, rongeur, 45° up, 3mm, 18cm
1x	41512-04	FERRIS-SMITH-KERRISON, rongeur, 45° up, 4mm, 18cm
1x	41432-01	LOVE-GRUENWALD, laminectomy rongeur, str., 3x10mm, 18cm
1x	41432-02	LOVE-GRUENWALD, laminectomy rongeur, 45° up, 3x10mm, 18cm
1x	41432-03	LOVE-GRUENWALD, laminectomy rongeur, 45° down, 3x10mm, 18cm
1x	41254-13	DAVIS, brain spatula, 13mm, 18cm
1x	41161-01	PENFIELD, dura dissector, 17,5cm
1x	41161-02	PENFIELD, dura dissector, 19,5cm
1x	41161-03	PENFIELD, dura dissector, 19,5cm
1x	41161-04	PENFIELD, dura dissector, 21,5cm
1x	41298-12	FRAZIER, canula, 3mm, 12cm
1x	41052-20	DANDY, nerve hook, str., 20cm
1x	19235-21	CUSHING, retractor, 21,5cm
1x	34231-15	ADSON, forceps, 15cm
2x	41094-00	GIGLI, handle for wire saw
5x	41092-50	OLIVECRONA, wire saw, 50cm
1x	41090-33	DE MARTEL, saw conductor, 33cm

**Set / 201 Craniotomy Set - Kraniotomie Set**

1x	07103-00	scalpel handle no. 3
1x	07107-00	scalpel handle no. 7
1x	07104-00	scalpel handle no. 4
1x	09140-14	DEAVER, dissecting scissors, str., 14,5cm
1x	09160-17	MAYO, dissecting scissors, str., 17cm
1x	09161-17	MAYO, dissecting scissors, cvd., 17cm
1x	09281-18	METZENBAUM, dissecting scissors, cvd., 18cm
2x	11170-12	ADSON, dressing forceps, 12cm
2x	11180-12	ADSON, tissue forceps, 1x2 teeth, 12cm
1x	11220-17	CUSHING, dressing forceps, str., 17cm
1x	11222-17	CUSHING, tissue forceps, str., 1x2 teeth, 17cm
1x	11315-01	TAYLOR, dressing forceps, bayonet, 17cm
1x	11315-02	TAYLOR, tissue forceps, 1x2 teeth, bayonet, 17cm
2x	41295-08	FRAZIER/FERGUSSON, suction tube, 30°, Charr. 8, 19cm
10x	13220-12	HALSTED-MOSQUITO, hemostatic forceps, str., 12,5cm
10x	13221-12	HALSTED-MOSQUITO, hemostatic forceps, cvd., 12cm
10x	13345-14	DANDY, hemostatic forceps, cvd., 14cm
10x	15111-13	BACKHAUS, towel forceps, 13cm
5x	17170-25	FOERSTER, swab forceps, str., 25cm
2x	19235-21	CUSHING, retractor, 21,5cm
2x	19214-13	FRAZIER, nerve hooklet, 13cm
1x	19630-10	JANSEN, retractor, 10cm
2x	19670-20	WEITLANER, retractor, 20cm
1x	33483-00	BRUNS, bone curette, Fig.0, str., 23cm
1x	33483-01	BRUNS, bone curette, Fig.1, str., 23cm
1x	33483-02	BRUNS, bone curette, Fig.2, str., 23cm
1x	33483-03	BRUNS, bone curette, Fig.3, str., 23cm
1x	33137-17	LUER, bone rongeur, cvd., 17cm
1x	33151-16	LEMPERT, bone rongeur, cvd., 16cm
1x	33230-22	STILLE-LUER, bone rongeur, str., 22cm
1x	33231-22	STILLE-LUER, bone rongeur, cvd., 22cm
1x	41096-21	DeVILBIS, skull punch, 21cm
1x	41432-01	LOVE-GRUENWALD, laminectomy rongeur, str., 3x10mm, 18cm
1x	41432-02	LOVE-GRUENWALD, laminectomy rongeur, 45° up, 3x10mm, 18cm
1x	41432-03	LOVE-GRUENWALD, laminectomy rongeur, 45° down, 3x10mm, 18cm
1x	09619-17	SCHMIEDEN-TAYLOR, dura scissors, 17cm
1x	41254-13	DAVIS, brain spatula, 13mm, 18cm
1x	41250-11	CUSHING, brain spatula, 8x10mm
1x	41253-11	OLIVECRONA, brain spatula, 11mm/13mm
1x	41158-01	FRAZIER, dura dissector, 15cm
2x	41298-12	FRAZIER, canula 3mm/12cm
1x	41052-20	DANDY, nerve hook, str., 20cm
1x	19234-20	CUSHING, retractor, 20cm
1x	34240-27	HUDSON, bone hand drill, 27cm
1x	34231-15	ADSON, forceps, 15cm
2x	41094-00	GIGLI, handle for wire saw
10x	41092-50	OLIVECRONA, wire saw, 50cm
2x	41090-33	DeMARTEL, saw conductor, 33cm
1x	41028-00	RANEY, applying forceps
1x	91162-19	bipolar forceps, 0,3mm, 19,5cm
1x	91193-30	bipolar connecting cable, 3 meter

**Set / 202 Laminectomy Set - Laminektomie Set**

1x	07103-00	scalpel handle no. 3
1x	07104-00	scalpel handle no. 4
1x	09140-14	DEAVER, dissecting scissors, str., 14,5cm
1x	09160-17	MAYO, dissecting scissors, str., 17cm
1x	09161-17	MAYO, dissecting scissors, cvd., 17cm
1x	09281-18	METZENBAUM, dissecting scissors, cvd., 18cm
2x	11102-14	dressing forceps, 14,5cm
1x	11102-20	dressing forceps, 20cm
2x	11120-14	tissue forceps, 1x2 teeth, 14,5cm
1x	11120-20	tissue forceps, 1x2 teeth, 20cm
1x	11220-17	CUSHING, dressing forceps, str., 17cm
1x	11222-17	CUSHING, tissue forceps, str., 1x2 teeth, 17cm
1x	11315-01	TAYLOR, dressing forceps, bayonet, 17cm
1x	11315-02	TAYLOR, tissue forceps, 1x2 teeth, bayonet, 17cm
1x	41295-08	FRAZIER/FERGUSSON, suction tube, 30°, Charr.8, 19cm
1x	41295-10	FRAZIER/FERGUSSON, suction tube, 30°, Charr. 10, 19cm
1x	41295-12	FRAZIER/FERGUSSON, suction tube, 30°, Charr. 12, 19cm
2x	25180-16	MAYO-HEGAR, needle holder, 16cm
10x	13220-12	HALSTED-MOSQUITO, hemostatic forceps, str., 12,5cm
10x	13221-12	HALSTED-MOSQUITO, hemostatic forceps, cvd., 12cm
6x	13263-16	CRILE-RANKIN, hemostatic forceps, cvd., 16cm
6x	13265-16	CRILE-RANKIN, hemostatic forceps, 1x2 teeth, cvd., 16cm
5x	17170-25	FOERSTER, swab forceps, str., 25cm
2x	19235-21	CUSHING, retractor, 21,5cm
2x	19281-04	VOLKMANN, retractor, 4 teeth, 21,5cm
2x	19670-20	WEITLANER, retractor, sharp, 20cm
1x	19686-32	ADSON, retractor, blunt, 32cm
1x	19690-31	BECKMANN, retractor, sharp, 31cm
1x	33711-20	LANGENBECK, elevator, 8mm, 20cm
1x	33710-19	LANGENBECK, elevator, 16mm, 19cm
1x	33700-03	BERGMANN, hammer, Ø 45mm, 300 gr., 24cm
1x	33482-98	BRUNS, bone curette, Fig.00, str., 23cm
1x	33483-00	BRUNS, bone curette, Fig.0, str., 23cm
1x	33483-01	BRUNS, bone curette, Fig.1, str., 23cm
1x	33483-02	BRUNS, bone curette, Fig.2, str., 23cm
1x	33483-03	BRUNS, bone curette, Fig.3, str., 23cm
1x	33483-04	BRUNS, bone curette, Fig.4, str., 23cm
1x	33483-05	BRUNS, bone curette, Fig.5, str., 23cm
1x	33483-06	BRUNS, bone curette, Fig.6, str., 23cm
1x	33136-17	LUER, bone rongeur, str., 17cm
1x	33231-22	STILLE-LUER, bone rongeur, cvd., 22cm
1x	33235-23	STILLE-LUER, bone rongeur, 23cm
1x	33293-27	STILLE-HORSLEY, bone cutting forceps, 27cm
1x	33290-27	STILLE-LISTON, bone cutting forceps, 27cm
5x	65120-15	ALLIS, tissue forceps, 5x6 teeth, 15cm
1x	41512-02	FERRIS-SMITH-KERRISON, 45° up, 2mm, 18cm
1x	41512-03	FERRIS-SMITH-KERRISON, 45° up, 3mm, 18cm
1x	41512-04	FERRIS-SMITH-KERRISON, 45° up, 4mm, 18cm
1x	41432-01	LOVE-GRUENWALD, laminectomy rongeur, str., 3x10mm, 18cm
1x	41432-02	LOVE-GRUENWALD, laminectomy rongeur, 45° up, 3x10mm, 18cm
1x	41432-03	LOVE-GRUENWALD, laminectomy rongeur, 45° down, 3x10mm, 18cm

1x	41151-24	DAVIS, dura dissector, 24cm
1x	47415-18	FREER, septum elevator, 18cm
1x	41161-00	PENFIELD, dura dissector, 17,5cm
1x	41161-02	PENFIELD, dura dissector, 19,5cm
1x	41161-03	PENFIELD, dura dissector, 19,5cm
1x	41161-04	PENFIELD, dura dissector, 21,5cm
1x	41052-20	DANDY, nerve hook, str., 20cm
1x	41056-18	CUSHING, nerve hook, 18cm
1x	41074-23	SCOVILLE, retractor, str., 23cm
1x	19911-00	SCOVILLE, frame only, 15cm
1x	19912-50	SCOVILLE, hook only, 50mm
1x	19917-64	SCOVILLE, blade only, 64x25mm
1x	41020-00	clip carrier with 1 holder
1x	41019-14	OLIVECRONA-TOENNIS, 140mm
1x	91162-19	bipolar forceps, 0,3mm, 19,5cm
1x	91193-30	bipolar connecting cable, 3 meter

**Set / 203 Skull Traction Set - Schädel Traktion Set**

1x	07103-00	scalpel handle no. 3
1x	09160-14	MAYO, dissecting scissors, str., 14,5cm
1x	11120-14	tissue forceps, 1x2 teeth, 14,5cm
1x	13220-12	HALSTED-MOSQUITO, hemostatic forceps, str., 12,5cm
1x	13221-12	HALSTED-MOSQUITO, hemostatic forceps, cvd., 12cm
2x	17170-25	FOERSTER, swab forceps, str., 25cm
1x	41025-02	CRUTCHFIELD, traction long
1x	34240-27	HUDSON, bone hand drill, complete, 27cm
6x	15111-09	BACKHAUS, towel forceps, 9cm

**Set / 204 Transphenoidal Hypophysectomy Set -  
Transphenoidal Hypophysektomie Set**

2x	07103-00	scalpel handle no. 3
1x	07104-00	scalpel handle no. 4
1x	09120-14	operating scissors, standard, str., 14cm
1x	11110-14	dressing forceps, narrow, 14cm
1x	09375-11	STRABISMUS, scissors TC, cvd., 11cm
1x	11170-12	ADSON, dressing forceps, 12cm
1x	11180-12	ADSON, tissue forceps, 1x2 teeth, 12cm
1x	47154-20	JANSEN, nasal forceps, 20cm
2x	41295-08	FRAZIER/FERGUSON, suction tube, 30°, Charr. 8, 19cm
2x	41295-10	FRAZIER/FERGUSON, suction tube, 30°, Charr. 10, 19cm
2x	41295-12	FRAZIER/FERGUSON, suction tube, 30°, Charr. 12, 19cm
2x	25144-13	HALSEY, needle holder TC, 13cm
2x	13221-12	HALSTED-MOSQUITO, hemostatic forceps, cvd., 12cm
2x	13211-10	HARTMANN, hemostatic forceps, cvd., 10cm
2x	13475-14	MIXTER-BABY, hemostatic forceps, 14cm
2x	19160-17	SENN-MILLER, retractor, 3 teeth, 17cm
6x	15111-13	BACKHAUS, towel forceps, 13cm
2x	17170-25	FOERSTER, swab forceps, str., 25cm
2x	19221-03	nerve and wound hooks, 3 prongs, 16cm
1x	41522-03	COLCLOUGH, disc rongeur, 90° up, 3mm, 20cm
1x	41512-02	FERRIS-SMITH-KERRISON, rongeur, 45° up, 2mm, 18cm
1x	41512-03	FERRIS-SMITH-KERRISON, rongeur, 45° up, 3mm, 18cm
1x	41422-01	CUSHING, laminectomy rongeur, str., 2x10mm, 18cm
1x	41432-01	LOVE-GRUENWALD, laminectomy rongeur, str., 3x10mm, 18cm
1x	41432-02	LOVE-GRUENWALD, laminectomy rongeur, 45° up, 3x10mm, 18cm
1x	41442-01	SPURLING, laminectomy rongeur, str., 4x10mm, 18cm
1x	41254-13	DAVIS, brain spatula, 13mm, 18cm
1x	41447-27	LANDOLT, tumor grasping forceps, Ø 9mm, 27cm
1x	93670-01	HARDY, enucleator, blunt, right, 24,5cm
1x	93670-09	HARDY, implant fork, 24,5cm
1x	93700-06	HARDY, curette, malleable, 6mm, 26cm
1x	93660-01	NICOLA, curette, malleable, 6,5mm, right, 21,5cm
1x	93660-02	NICOLA, curette, malleable, 6,5mm, left, 21,5cm
1x	93660-03	NICOLA, curette, malleable, 6,5mm, 21,5cm
1x	93600-01	CUSHING-LANDOLT, specula, 70x15mm
1x	93600-02	CUSHING-LANDOLT, specula, 90x15mm
1x	93605-21	LANDOLT, spreader for specula, 21cm
1x	93710-03	LANDOLT-REULEN, raspatory, 2,2mm, 26cm
1x	93710-04	LANDOLT-REULEN, raspatory, 3,2mm, 26cm
1x	93710-07	LANDOLT-REULEN, dissector, 2,0mm, 26cm
1x	93720-02	NICOLA, forceps, scoop-shaped, str., 16,5cm
1x	93720-04	NICOLA, grasping forceps, str., 16,5cm
1x	93720-03	NICOLA, micro scissors, str., 16,5cm
1x	93630-04	COTTLE, chisel, 4mm, 18,5cm
1x	33700-05	COTTLE, hammer, Ø 30mm, 240 gr., 18cm







NUMMERNVERZEICHNIS

NUMERICAL INDEX

INDICE NUMÉRICO

INDICE NUMERICO



[www.hadeo.co](http://www.hadeo.co)



Nummernverzeichnis  
Numerical Index  
Indice numérico  
Indice numerico

03288-17	.....8	09161-17	.....22	09287-18	.....23	09540-16	.....21	10229-18T	.....40
03288-20	.....8	09161-23	.....22	09287-20	.....23	09541-16	.....21	10229-21	.....40
03292-22	.....8	09164-14	.....22	09287-23	.....23	09542-16	.....21	10229-23	.....40
03294-24	.....8	09164-17	.....22	09287-25	.....23	09543-16	.....21	10230-11	.....40
03304-20	.....8	09164-23	.....22	09310-12	.....26	09582-15	.....27	10230-14	.....40
03306-17	.....8	09165-14	.....22	09310-15	.....26	09583-15	.....27	10230-18	.....40
03308-18	.....8	09165-17	.....22	09312-12	.....26	09601-22	.....33	10230-18T	.....40
03320-19	.....11	09165-23	.....22	09314-12	.....26	09610-18	.....27	10230-21	.....40
03340-10	.....11	09170-15	.....22	09321-15	.....26	09611-18	.....27	10230-23	.....40
03340-15	.....11	09170-17	.....22	09321-18	.....26	09617-17	.....33	11112-18	.....50
03340-20	.....11	09170-21	.....22	09322-13	.....26	09619-17	.....34	11112-21	.....50
03340-30	.....11	09171-15	.....22	09325-15	.....26	09620-23	.....33	11112-25	.....50
03340-50	.....11	09171-17	.....22	09340-09	.....27	09831-12	.....34	11116-18	.....50
03350-15	.....11	09171-21	.....22	09340-10	.....27	09835-12	.....34	11116-21	.....50
03360-01	.....11	09174-15	.....22	09340-11	.....27	10120-18	.....35	11116-25	.....50
07103-00	.....14	09174-17	.....22	09341-09	.....27	10121-18	.....35	11126-18	.....50
07103-01	.....14	09174-21	.....22	09341-10	.....27	10122-18	.....35	11126-21	.....50
07106-01	.....14	09175-15	.....22	09341-11	.....27	10123-18	.....35	11126-25	.....50
07107-00	.....15	09175-17	.....22	09344-11	.....27	10133-10	.....36	11170-12	.....51
07107-01	.....15	09175-21	.....22	09345-11	.....27	10135-10	.....36	11170-15	.....51
07109-10	.....15	09190-16	.....22	09346-11	.....27	10140-08	.....37	11174-12	.....51
07109-13	.....15	09191-16	.....22	09350-09	.....28	10141-08	.....37	11174-15	.....51
07109-15	.....15	09194-16	.....22	09351-09	.....28	10143-08	.....37	11176-12	.....51
07161-00	.....15	09195-16	.....22	09352-09	.....28	10202-11	.....38	11176-15	.....51
07162-00	.....15	09280-12	.....23	09353-09	.....28	10202-14	.....38	11177-12	.....51
07165-00	.....15	09280-15	.....23	09360-11	.....28	10202-14T	.....38	11178-12	.....51
07167-00	.....15	09280-18	.....23	09361-11	.....28	10202-18	.....38	11179-12	.....51
07290-09	.....17	09280-20	.....23	09362-11	.....28	10202-18T	.....38	11180-12	.....52
07291-11	.....17	09280-23	.....23	09363-11	.....28	10202-21	.....38	11180-15	.....52
07294-13	.....17	09280-25	.....23	09371-11B	.....25	10202-21T	.....38	11181-12	.....52
09102-13	.....20	09281-12	.....23	09473-21	.....29	10202-23	.....38	11181-15	.....52
09102-14	.....20	09281-15	.....23	09474-22	.....29	10203-11	.....38	11186-12	.....52
09102-16	.....20	09281-15B	.....24	09475-00	.....29	10203-14	.....38	11186-15	.....52
09102-18	.....20	09281-18	.....23	09475-25	.....29	10203-14T	.....38	11187-12	.....52
09103-13	.....20	09281-18B	.....24	09475-45	.....29	10203-18	.....38	11187-18	.....53
09103-14	.....20	09281-20	.....23	09475-60	.....29	10203-18T	.....38	11187-20	.....53
09103-16	.....20	09281-20B	.....24	09475-90	.....29	10203-21	.....38	11187-25	.....53
09103-18	.....20	09281-23	.....23	09476-00	.....29	10203-21T	.....38	11187-30	.....53
09104-14	.....20	09281-25	.....23	09476-25	.....29	10203-23	.....38	11188-12	.....52
09105-14	.....20	09282-15	.....23	09476-45	.....29	10220-00	.....39	11188-15	.....52
09110-13	.....20	09282-18	.....23	09476-60	.....29	10220-00T	.....39	11189-12	.....52
09110-14	.....20	09282-20	.....23	09476-90	.....29	10220-25	.....39	11189-15	.....53
09110-16	.....20	09282-23	.....23	09477-01	.....30	10220-25T	.....39	11189-20	.....53
09110-18	.....20	09282-25	.....23	09478-25	.....30	10220-45	.....39	11189-25	.....53
09111-13	.....20	09283-15	.....23	09478-45	.....30	10220-45T	.....39	11220-17	.....53
09111-14	.....20	09283-15B	.....25	09478-60	.....30	10220-60	.....39	11221-17	.....53
09111-16	.....20	09283-18	.....23	09479-25	.....30	10220-60T	.....39	11222-17	.....53
09111-18	.....20	09283-18B	.....24	09479-45	.....30	10220-90	.....39	11223-17	.....53
09114-14	.....20	09283-20	.....23	09479-60	.....30	10220-90T	.....39	11224-17	.....53
09115-14	.....20	09283-20B	.....24	09480-18	.....30	10226-11	.....40	11225-17	.....53
09120-13	.....20	09283-23	.....23	09480-25	.....31	10226-14	.....40	11231-20	.....54
09120-14	.....20	09283-25	.....23	09480-25 SC	.....31	10226-18	.....40	11233-20	.....54
09120-16	.....20	09284-12	.....23	09480-40	.....31	10226-18T	.....40	11234-20	.....54
09120-18	.....20	09284-15	.....23	09480-40 SC	.....31	10226-21	.....40	11235-20	.....54
09121-13	.....20	09284-18	.....23	09480-60	.....31	10226-23	.....40	11236-15	.....54
09121-14	.....20	09284-20	.....23	09480-60 SC	.....31	10227-11	.....40	11236-20	.....54
09121-16	.....20	09284-23	.....23	09481-25	.....31	10227-14	.....40	11237-20	.....55
09121-18	.....20	09284-25	.....23	09481-40	.....31	10227-18	.....40	11257-15	.....55
09124-14	.....20	09285-12	.....23	09481-60	.....31	10227-18T	.....40	11258-15	.....55
09125-14	.....20	09285-15	.....23	09490-16	.....31	10227-21	.....40	11259-15	.....55
09130-14	.....21	09285-18	.....23	09490-23	.....31	10227-23	.....40	11260-12	.....56
09131-14	.....21	09285-20	.....23	09490-28	.....31	10228-11	.....40	11260-15	.....56
09140-14	.....21	09285-23	.....23	09491-16	.....31	10228-14	.....40	11261-15	.....56
09141-14	.....21	09285-25	.....23	09491-23	.....31	10228-18	.....40	11270-12	.....56
09150-14	.....21	09286-15	.....23	09491-28	.....31	10228-18T	.....40	11270-15	.....56
09151-14	.....21	09286-18	.....23	09492-16	.....31	10228-21	.....40	11271-15	.....56
09160-14	.....22	09286-20	.....23	09492-23	.....31	10228-23	.....40	11271-18	.....56
09160-17	.....22	09286-23	.....23	09492-28	.....31	10229-11	.....40	11272-15	.....56
09160-23	.....22	09286-25	.....23	09496-15	.....32	10229-14	.....40	11273-15	.....56
09161-14	.....22	09287-15	.....23	09497-15	.....32	10229-18	.....40	11274-06	.....56

Nummernverzeichnis  
Numerical Index  
Indice numérico  
Indice numerico



11274-08	.....56	12112-18D	.....66	13006-10	.....78	13115-00	.....83	19216-07	.....102
11274-10	.....56	12112-18T	.....66	13006-14	.....78	13210-10	.....83	19216-10	.....102
11302-17	.....56	12112-21D	.....66	13006-20	.....78	13211-10	.....83	19234-20	.....103
11302-23	.....56	12112-21T	.....66	13010-30	.....79	13212-10	.....83	19235-21	.....103
11303-17	.....56	12112-23D	.....66	13010-35	.....79	13213-10	.....83	19314-07	.....104
11304-17	.....56	12112-23T	.....66	13010-40	.....79	13214-10	.....83	19314-10	.....104
11305-17	.....57	12114-15D	.....66	13010-50	.....79	13215-10	.....83	19314-12	.....104
11310-17	.....57	12114-15T	.....66	13011-30	.....79	13220-12	.....84	19314-14	.....104
11311-17	.....57	12114-18D	.....66	13011-35	.....79	13220-14	.....84	19314-15	.....104
11312-17	.....57	12114-18T	.....66	13011-40	.....79	13220-18	.....84	19314-16	.....104
11312-18	.....57	12114-21D	.....66	13011-50	.....79	13221-12	.....84	19314-20	.....104
11313-17	.....57	12114-21T	.....66	13012-30	.....79	13221-14	.....84	19315-06	.....104
11314-01	.....58	12114-23D	.....66	13012-35	.....79	13221-18	.....84	19315-21	.....104
11314-02	.....58	12114-23T	.....66	13012-40	.....79	13222-12	.....84	19317-21	.....105
11315-01	.....58	12115-15	.....67	13012-50	.....79	13223-12	.....84	19318-40	.....105
11315-02	.....58	12115-15T	.....67	13013-30	.....79	13224-12	.....84	19318-57	.....105
11324-23	.....58	12115-18	.....67	13013-35	.....79	13225-12	.....84	19318-78	.....105
11325-15	.....58	12115-18T	.....67	13013-40	.....79	13226-12	.....84	19330-40	.....104
11325-23	.....58	12115-21	.....67	13013-50	.....79	13227-12	.....84	19330-55	.....104
11325-25	.....58	12115-21T	.....67	13014-30	.....79	13230-12	.....84	19620-07	.....120
11326-23	.....58	12115-23	.....67	13014-35	.....79	13230-14	.....84	19620-10	.....120
11327-10	.....59	12115-23T	.....67	13014-40	.....79	13231-12	.....84	19621-07	.....120
11327-13	.....59	12116-15	.....67	13014-50	.....79	13231-14	.....84	19621-10	.....120
11401-01	.....60	12116-18	.....67	13015-30	.....79	13232-12	.....84	19630-10	.....120
11403-03	.....60	12116-21	.....67	13015-35	.....79	13233-12	.....84	19631-10	.....120
11403-04	.....60	12116-23	.....67	13015-40	.....79	13240-14	.....85	19634-10	.....120
11404-04	.....60	12117-18	.....68	13015-50	.....79	13240-18	.....85	19635-10	.....120
11405-05	.....60	12117-21	.....68	13090-40	.....80	13241-14	.....85	19640-14	.....127
11407-07	.....60	12117-23	.....68	13090-45	.....80	13241-18	.....85	19641-14	.....127
11408-01	.....61	12118-18	.....68	13090-50	.....80	13242-16	.....85	19650-10	.....121
11408-02	.....61	12118-21	.....68	13091-40	.....80	13243-16	.....85	19651-10	.....121
11408-03	.....61	12118-23	.....68	13091-45	.....80	13244-14	.....85	19654-13	.....121
11408-04	.....61	12295-22	.....70	13091-50	.....80	13245-14	.....85	19655-13	.....121
11409-11	.....61	12297-22	.....70	13092-07	.....81	13250-14	.....85	19670-14	.....121
11410-11	.....61	12300-18	.....70	13092-08	.....81	13250-18	.....85	19670-16	.....121
11411-11	.....61	12302-16	.....69	13092-10	.....81	13251-14	.....85	19670-20	.....121
12090-15D	.....62	12302-18	.....70	13092-12	.....81	13251-18	.....85	19670-24	.....121
12090-18D	.....62	12302-20	.....69	13093-07	.....81	13254-14	.....85	19671-14	.....121
12090-21D	.....62	12302-24	.....69	13093-08	.....81	13255-14	.....85	19671-16	.....121
12090-23D	.....62	12303-18	.....70	13093-10	.....81	13262-16	.....85	19671-20	.....121
12091-15D	.....62	12304-16	.....69	13093-12	.....81	13263-16	.....85	19671-24	.....121
12091-18D	.....62	12304-20	.....69	13094-09	.....82	13345-12	.....86	19672-11	.....122
12091-21D	.....62	12304-24	.....69	13095-10	.....82	13345-14	.....86	19673-11	.....122
12091-23D	.....62	12304-30	.....69	13096-06	.....81	13364-14	.....87	19674-15	.....122
12102-12	.....62	12305-20	.....71	13096-07	.....81	13366-19	.....87	19675-00	.....123
12102-12D	.....62	12306-16	.....69	13096-09	.....81	13414-20	.....88	19675-13	.....122
12102-21	.....62	12306-20	.....69	13096-11	.....81	13415-18	.....88	19676-00	.....123
12102-21D	.....62	12306-24	.....69	13097-06	.....81	13415-18	.....88	19677-13	.....124
12102-23	.....62	12306-30	.....69	13097-07	.....81	13431-13	.....89	19677-19	.....123
12102-23D	.....62	12308-16	.....69	13097-09	.....81	13431-16	.....89	19677-25	.....123
12103-12	.....62	12308-20	.....69	13097-11	.....81	13431-18	.....89	19677-32	.....123
12103-12D	.....62	12308-24	.....69	13098-06	.....80	13431-20	.....89	19678-05	.....123
12103-15	.....62	12308-30	.....69	13099-07	.....80	13431-23	.....89	19678-06	.....123
12103-15D	.....62	12309-16	.....69	13102-04	.....83	13431-25	.....89	19678-16	.....124
12104-15	.....62	12309-20	.....69	13102-05	.....83	13431-28	.....89	19679-20	.....128
12104-15D	.....62	12309-24	.....69	13103-04	.....83	13475-14	.....90	19679-22	.....124
12108-18	.....62	12309-30	.....69	13103-05	.....83	13475-18	.....90	19680-19	.....125
12108-18D	.....62	12310-16	.....69	13110-50	.....83	13610-01	.....91	19681-19	.....125
12109-18	.....62	12310-20	.....69	13110-55	.....83	13610-02	.....91	19681-21	.....125
12109-18D	.....62	12310-24	.....69	13110-65	.....83	13610-03	.....91	19682-26	.....126
12109-21	.....62	12310-30	.....69	13110-70	.....83	19128-18	.....103	19683-26	.....126
12109-21D	.....62	13001-08	.....78	13110-75	.....83	19128-20	.....103	19684-14	.....126
12109-23	.....62	13001-10	.....78	13110-90	.....83	19128-23	.....103	19684-16	.....126
12109-23D	.....62	13001-12	.....78	13111-50	.....83	19214-13	.....102	19684-20	.....126
12110-15	.....65	13002-08	.....78	13111-55	.....83	19214-18	.....102	19684-26	.....126
12110-20	.....65	13002-10	.....78	13111-65	.....83	19215-13	.....102	19685-14	.....126
12110-24	.....65	13002-12	.....78	13111-70	.....83	19215-18	.....102	19685-16	.....126
12110-30	.....65	13005-10	.....78	13111-75	.....83	19216-01	.....102	19685-20	.....126
12112-15D	.....66	13005-14	.....78	13111-90	.....83	19216-02	.....102	19685-26	.....126
12112-15T	.....66	13005-20	.....78	13113-03	.....82	19216-05	.....102	19686-32	.....129



Nummernverzeichnis  
Numerical Index  
Indice numérico  
Indice numerico

19687-01	130	19729-55T	145	19743-55	157	19802-14	150	25214-23	95
19687-02	130	19729-60T	145	19743-60	157	19802-16	150	25214-26	95
19688-01	130	19729-65T	145	19743-65	157	19802-18	150	25224-13	95
19688-02	130	19729-70T	145	19744-00	154	19910-00	137	25224-15	95
19689-01	131	19730-30T	145	19744-17	154	19910-01	137	25224-18	95
19689-02	131	19730-35T	145	19745-40	154	19911-00	137	25224-20	95
19690-31	132	19730-40T	145	19745-45	154	19911-01	137	25224-23	95
19692-32	132	19730-45T	145	19745-50	154	19912-50	137	25224-26	95
19693-01	128	19730-50T	145	19745-55	154	19912-70	137	25225-13	95
19693-02	128	19730-55T	145	19745-60	154	19913-50	137	25225-15	95
19693-28	133	19730-60T	145	19745-65	154	19913-70	137	25225-18	95
19694-01	106	19730-65T	145	19745-70	154	19914-41	137	25225-20	95
19694-02	106	19730-70T	145	19748-01	148	19914-67	137	25225-23	95
19694-03	106	19731-35T	145	19748-02	148	19915-48	137	25225-26	95
19694-18	134	19731-40T	145	19748-03	148	19915-64	137	25660-12	96
19695-01	135	19731-45T	145	19748-04	148	19916-64	137	25660-13	96
19695-02	135	19731-50T	145	19748-40	155	19916-80	137	25660-14	96
19695-18	134	19731-55T	145	19748-45	155	19917-64	137	25661-12	96
19696-18	147	19731-60T	145	19748-50	155	19918-64	137	25661-13	96
19698-18	147	19731-65T	145	19748-55	155	19918-88	137	25661-14	96
19710-00	140	19731-70T	145	19748-60	155	19919-00	138	25668-18	97
19710-01	140, 141	19731-75T	145	19748-65	155	19919-01	138	25668-21	97
19710-40	140, 142	19732-25T	146	19748-70	155	19919-02	138	25668-23	97
19710-45	140, 142	19732-30T	146	19748-75	155	19919-03	138	25670-14	97
19710-50	140, 142	19732-35T	146	19748-85	155	19919-04	138	25670-18	97
19710-55	140, 142	19732-40T	146	19749-01	148	19919-05	138	25670-21	97
19710-60	140, 142	19732-45T	146	19749-02	148	19920-01	158	25671-12D	96
19711-00	142	19732-50T	146	19750-01	149	19920-02	158	25671-13D	96
19711-01	142, 143	19732-55T	146	19750-02	149	19930-00	156	25671-14	97
19711-40	141, 143	19732-60T	146	19750-03	149	19930-01	156	25671-14D	96
19711-45	141, 143	19732-65T	146	19750-04	149	19930-02	158	25671-18	97
19711-50	141, 143	19732-70T	146	19750-05	149	19930-03	158	25672-14	97
19711-55	141, 143	19736-25T	146	19750-06	149	19940-01	159	25672-14D	97
19711-60	141, 143	19736-30T	146	19751-01	149	19940-02	159	25672-14T	97
19712-00	141	19736-35T	146	19751-02	149	19950-14	160	25672-18	97
19713-00	143	19736-40T	146	19751-03	149	19960-20	160	25672-18D	97
19721-00	144	19736-45T	146	19751-04	149	19970-12	160	25672-18T	97
19721-15	144	19736-50T	146	19751-05	149	19970-14	160	25672-21	97
19724-40	146	19736-55T	146	19751-06	149	19970-16	160	25672-21D	97
19724-45	146	19736-60T	146	19770-00	136	19970-18	160	25672-21T	97
19724-50	146	19736-65T	146	19770-11	136	25130-13	94	25672-23	97
19724-55	146	19736-70T	146	19772-38	136	25134-13	94	25672-23D	97
19724-60	146	19738-45	144, 146	19772-58	136	25140-13	94	25673-14	97
19725-40	146	19738-50	144, 146	19774-32	136	25144-13	94	25673-14D	97
19725-45	146	19738-55	144, 146	19774-37	136	25148-13	94	25673-14T	97
19725-50	146	19738-60	144, 146	19774-43	136	25150-14	94	25673-18	97
19725-55	146	19738-65	144, 146	19774-47	136	25154-14	94	25673-18D	97
19725-60	146	19739-30T	146	19774-52	136	25160-15	94	25673-18T	97
19726-01	144, 156	19739-35T	146	19774-57	136	25160-18	94	25673-21T	97
19727-25T	145	19739-40T	146	19774-62	136	25160-20	94	25674-14	97
19727-30T	145	19739-45T	146	19774-67	136	25160-23	94	25674-18	97
19727-35T	145	19739-50T	146	19776-32	136	25164-15	94	25674-21	97
19727-40T	145	19739-55T	146	19776-37	136	25164-18	94	25675-14	97
19727-45T	145	19739-60T	146	19776-43	136	25164-20	94	25675-18	97
19727-50T	145	19739-65T	146	19776-47	136	25164-23	94	25676-14	97
19727-55T	145	19739-70T	146	19776-52	136	25164-18	94	25677-14	97
19727-60T	145	19739-75T	146	19776-57	136	25180-14	95	25691-18	97
19728-25T	145	19742-35	156, 157	19776-62	136	25180-16	95	25700-18	96
19728-30T	145	19742-40	156, 157	19776-67	136	25180-18	95	25701-18	96
19728-35T	145	19742-45	156, 157	19778-32	136	25180-20	95	25720-12	96
19728-40T	145	19742-50	156, 157	19778-37	136	25180-24	95	25720-12D	96
19728-45T	145	19742-55	156, 157	19778-43	136	25180-26	95	25720-13	96
19728-50T	145	19742-60	156, 157	19778-47	136	25184-14	95	25720-13D	96
19728-55T	145	19742-65	157	19778-52	136	25184-16	95	25720-14	96
19728-60T	145	19742-75	157	19778-57	136	25184-18	95	25720-14D	96
19729-30T	145	19742-85	157	19778-62	136	25184-20	95	25730-18	96
19729-35T	145	19743-35	157	19778-67	137	25184-24	95	25730-18D	96
19729-40T	145	19743-40	157	19779-00	136	25184-26	95	25730-21	96
19729-45T	145	19743-45	157	19802-09	150	25214-16	95	25730-21D	96
19729-50T	145	19743-50	157	19802-11	150	25214-18	95	25730-23	96
						25214-20	95		

Nummernverzeichnis  
Numerical Index  
Indice numérico  
Indice numerico



25730-23D.....96	33275-14 .....172	33481-04 .....188	33631-10 .....196	33651-04 .....198
25731-12 .....96	33275-17 .....172	33481-05 .....188	33631-12 .....196	33651-06 .....198
25731-13 .....96	33275-19 .....172	33481-06 .....188	33631-15 .....196	33651-08 .....198
25731-14 .....96	33280-15 .....172	33482-01 .....187	33631-20 .....196	33651-10 .....198
25731-18 .....96	33281-15 .....172	33482-02 .....187	33631-25 .....196	33651-13 .....198
25731-18D .....96	33282-19 .....172	33482-03 .....187	33631-30 .....196	33651-16 .....198
25731-21 .....96	33283-17 .....172	33482-97 .....188	33632-06 .....196	33651-18 .....198
25731-21D .....96	33284-15 .....172	33482-98 .....188	33632-08 .....196	33651-20 .....198
25731-23 .....96	33286-18 .....172	33483-00 .....188	33632-10 .....196	33651-25 .....198
25731-23D .....96	33289-18 .....172	33483-01 .....188	33632-12 .....196	33651-30 .....198
33100-01 .....162	33290-23 .....173	33483-02 .....188	33632-15 .....196	33651-38 .....198
33100-02 .....162	33290-27 .....173	33483-03 .....188	33632-20 .....196	33651-44 .....198
33101-12 .....162	33291-23 .....173	33483-04 .....188	33632-25 .....196	33651-50 .....198
33101-14 .....162	33291-27 .....173	33483-05 .....188	33632-30 .....196	33652-02 .....199
33102-01 .....162	33292-26 .....173	33483-06 .....188	33633-06 .....196	33652-03 .....199
33102-02 .....162	33293-27 .....173	33484-97 .....188	33633-08 .....196	33652-04 .....199
33131-15 .....163	33295-24 .....173	33484-98 .....188	33633-10 .....196	33652-06 .....199
33133-15 .....163	33469-96 .....184	33485-00 .....188	33633-12 .....196	33652-08 .....199
33136-17 .....163	33469-97 .....184	33485-01 .....188	33633-15 .....196	33652-10 .....199
33137-17 .....163	33469-98 .....184	33485-02 .....188	33633-20 .....196	33652-12 .....199
33142-20 .....163	33470-00 .....184	33485-03 .....188	33633-25 .....196	33652-15 .....199
33143-20 .....163	33470-01 .....184	33485-04 .....188	33633-30 .....196	33654-02 .....199
33147-20 .....164	33470-02 .....184	33485-05 .....188	33634-06 .....196	33654-03 .....199
33148-18 .....164	33470-03 .....184	33485-06 .....188	33634-08 .....196	33654-04 .....199
33150-16 .....164	33470-04 .....184	33487-99 .....189	33634-10 .....196	33654-06 .....199
33151-16 .....164	33470-05 .....184	33488-00 .....189	33634-12 .....196	33654-08 .....199
33152-17 .....164	33470-06 .....184	33488-01 .....189	33634-15 .....196	33654-10 .....199
33153-17 .....164	33473-01 .....185	33488-02 .....189	33634-20 .....196	33654-12 .....199
33154-18 .....165	33473-02 .....185	33489-00 .....189	33634-25 .....196	33654-15 .....199
33155-18 .....165	33473-03 .....185	33489-01 .....189	33634-30 .....196	33656-28 .....200
33156-18 .....165	33473-04 .....185	33489-02 .....189	33644-06 .....197	33657-28 .....200
33157-02 .....165	33473-05 .....185	33489-03 .....189	33644-09 .....197	33658-28 .....200
33157-03 .....165	33473-06 .....185	33490-10 .....190	33644-13 .....197	33659-28 .....200
33157-04 .....166	33474-96 .....184	33490-20 .....190	33644-16 .....197	33660-07 .....201
33157-05 .....166	33474-97 .....184	33490-30 .....190	33644-19 .....197	33660-10 .....201
33157-06 .....166	33474-98 .....184	33490-40 .....190	33644-25 .....197	33660-15 .....201
33158-03 .....166	33475-00 .....184	33490-50 .....190	33644-32 .....197	33660-20 .....201
33158-04 .....166	33475-01 .....184	33491-01 .....190	33645-06 .....197	33660-25 .....201
33158-05 .....166	33475-02 .....184	33491-02 .....190	33645-09 .....197	33660-30 .....201
33159-03 .....166	33475-03 .....184	33491-03 .....190	33645-13 .....197	33661-07 .....201
33159-04 .....166	33475-04 .....184	33491-04 .....190	33645-16 .....197	33661-10 .....201
33159-05 .....166	33475-05 .....184	33491-05 .....191	33645-19 .....197	33661-15 .....201
33159-20 .....166	33475-06 .....184	33491-06 .....191	33645-25 .....197	33661-20 .....201
33201-18 .....167	33476-01 .....186	33491-07 .....191	33645-32 .....197	33661-25 .....201
33202-18 .....167	33476-02 .....186	33491-08 .....191	33647-06 .....197	33661-30 .....201
33205-18 .....167	33476-03 .....186	33492-13 .....192	33647-09 .....197	33664-04 .....201
33211-15 .....167	33476-98 .....186	33492-16 .....192	33647-14 .....197	33664-06 .....201
33213-15 .....167	33476-99 .....186	33492-20 .....192	33647-16 .....197	33664-08 .....201
33216-18 .....168	33477-00 .....186	33494-13 .....192	33647-19 .....197	33664-10 .....201
33217-18 .....168	33477-01 .....186	33494-14 .....192	33647-25 .....197	33664-12 .....201
33219-23 .....168	33477-02 .....186	33494-17 .....192	33647-32 .....197	33665-04 .....201
33220-20 .....168	33477-03 .....186	33495-16 .....192	33649-09 .....197	33665-06 .....201
33230-22 .....169	33477-04 .....186	33500-01 .....191	33649-14 .....197	33665-08 .....201
33230-26 .....169	33477-05 .....186	33500-02 .....191	33649-16 .....197	33665-10 .....201
33231-22 .....169	33477-06 .....186	33500-03 .....191	33649-19 .....197	33665-12 .....201
33231-26 .....169	33478-98 .....187	33508-22 .....194	33649-25 .....197	33665-24 .....202
33235-23 .....169	33478-99 .....187	33509-03 .....195	33649-32 .....197	33665-26 .....202
33237-23 .....169	33479-00 .....187	33509-05 .....195	33650-04 .....198	33665-55 .....202
33241-30 .....170	33479-01 .....187	33509-08 .....195	33650-06 .....198	33665-90 .....202
33243-30 .....170	33479-02 .....187	33510-12 .....195	33650-08 .....198	33666-22 .....202
33245-23 .....170	33479-03 .....187	33510-14 .....195	33650-10 .....198	33667-06 .....203
33247-23 .....170	33479-04 .....187	33510-16 .....195	33650-13 .....198	33667-08 .....203
33257-23 .....171	33479-05 .....187	33630-06 .....196	33650-16 .....198	33667-11 .....203
33258-23 .....171	33479-06 .....187	33630-08 .....196	33650-18 .....198	33667-16 .....203
33259-23 .....171	33480-97 .....188	33630-10 .....196	33650-20 .....198	33669-05 .....203
33260-24 .....171	33480-98 .....188	33630-12 .....196	33650-25 .....198	33669-10 .....203
33261-22 .....171	33481-00 .....188	33630-15 .....196	33650-30 .....198	33669-15 .....203
33274-14 .....172	33481-01 .....188	33630-20 .....196	33650-38 .....198	33670-05 .....203
33274-17 .....172	33481-02 .....188	33630-25 .....196	33650-44 .....198	33670-10 .....203
33274-19 .....172	33481-03 .....188	33630-30 .....196	33650-50 .....198	33670-15 .....203



Nummernverzeichnis  
Numerical Index  
Indice numérico  
Indice numerico

33691-34	.....9	33749-19	.....217	34816-19	.....181	41158-03	.....223	41290-21	.....230
33694-01	.....9	33750-08	.....217	41011-15	.....174	41161-01	.....224	41294-40	.....230
33694-03	.....9	33750-17	.....217	41011-19	.....174	41161-02	.....224	41295-06	.....231
33695-40	.....9	33751-01	.....260	41015-23	.....174	41161-03	.....224	41295-07	.....231
33699-17	.....9	33751-02	.....260	41015-26	.....174	41161-04	.....224	41295-08	.....231
33700-01	.....10	33751-03	.....260	41017-23	.....174	41161-05	.....224	41295-09	.....231
33700-01-01	.....10	33753-01	.....260	41017-26	.....174	41170-01	.....256	41295-10	.....231
33700-05	.....10	33753-02	.....260	41019-14	.....174	41170-02	.....256	41295-11	.....231
33700-07	.....10	33753-03	.....260	41020-00	.....174	41170-03	.....256	41295-12	.....231
33701-16	.....206	33754-17	.....218	41025-01	.....176	41170-04	.....256	41295-15	.....231
33702-15	.....206	33755-17	.....218	41025-02	.....176	41170-05	.....256	41297-06	.....231
33703-15	.....206	33756-17	.....218	41026-35	.....176	41170-06	.....256	41297-07	.....231
33704-01	.....206	33757-17	.....218	41026-50	.....176	41170-07	.....256	41297-08	.....231
33704-02	.....207	33758-04	.....217	41027-00	.....176	41170-08	.....256	41297-09	.....231
33705-05	.....207	33758-06	.....217	41028-00	.....176	41170-09	.....256	41297-10	.....231
33705-10	.....207	33758-08	.....217	41051-20	.....108	41170-10	.....256	41297-11	.....231
33705-15	.....207	33759-06	.....218	41052-20	.....108	41170-11	.....256	41297-12	.....231
33705-20	.....207	33759-12	.....218	41053-20	.....108	41170-12	.....256	41298-12	.....231
33705-25	.....207	33759-19	.....218	41054-20	.....109	41170-13	.....256	41299-03	.....231
33706-18	.....207	33759-25	.....218	41056-18	.....109	41170-14	.....256	41299-05	.....231
33707-15	.....207	33765-17	.....219	41056-28	.....109	41170-15	.....256	41299-07	.....231
33707-17	.....208	33767-19	.....219	41058-18	.....109	41210-23	.....261	41300-00	.....231
33708-19	.....208	33831-16	.....107	41058-28	.....109	41211-23	.....261	41300-02	.....232
33709-00	.....10	33833-16	.....107	41061-16	.....110	41213-23	.....261	41300-03	.....232
33709-01	.....10	33966-11	.....92	41064-16	.....110	41221-00	.....262	41300-04	.....232
33709-02	.....10	34210-20	.....322	41068-20	.....110	41222-00	.....262	41300-05	.....232
33709-03	.....10	34212-25	.....322	41069-20	.....110	41223-00	.....262	41300-06	.....231
33709-21	.....208	34212-30	.....322	41070-29	.....110	41224-00	.....262	41300-09	.....231
33710-01	.....208	34212-35	.....322	41074-23	.....111	41230-01	.....248	41301-15	.....232
33710-02	.....208	34212-40	.....322	41075-24	.....111	41230-02	.....248	41301-20	.....232
33710-07	.....209	34214-05	.....322	41076-03	.....111	41230-03	.....248	41301-25	.....232
33710-15	.....209	34214-08	.....322	41076-04	.....111	41230-05	.....248	41301-35	.....232
33710-19	.....209	34214-10	.....322	41076-05	.....111	41230-06	.....248	41302-01	.....232
33710-20	.....209	34214-12	.....322	41076-07	.....111	41231-19	.....249	41302-02	.....232
33711-16	.....210	34214-16	.....322	41077-04	.....112	41232-19	.....249	41303-09	.....233
33711-18	.....209	34216-10	.....322	41077-06	.....112	41233-19	.....249	41303-12	.....233
33711-20	.....209	34216-15	.....322	41077-08	.....112	41234-19	.....249	41303-15	.....233
33711-21	.....209	34216-20	.....322	41077-10	.....112	41236-19	.....118, 249	41303-18	.....233
33712-16	.....210	34220-24	.....323	41078-23	.....113	41237-19	.....118, 249	41303-25	.....233
33713-16	.....210	34222-25	.....323	41079-21	.....113	41238-19	.....249	41303-30	.....233
33713-17	.....210	34222-30	.....323	41080-19	.....114	41238-19-05	.....250	41303-45	.....233
33714-15	.....210	34222-35	.....323	41081-19	.....114	41238-19-10	.....250	41304-06	.....233
33715-20	.....210	34230-28	.....323	41083-19	.....114	41238-19-15	.....250	41304-08	.....233
33716-18	.....210	34231-15	.....181	41085-20	.....114	41239-19	.....249	41304-10	.....233
33717-19-01	.....211	34232-00	.....323	41090-33	.....177	41240-16	.....250	41306-00	.....234
33717-19-02	.....211	34240-27	.....324	41091-31	.....114	41242-19	.....116	41306-05	.....232, 234
33718-16	.....211	34241-00	.....324	41091-41	.....114	41243-19	.....116	41306-07	.....232, 234
33719-17	.....211	34242-09	.....324	41092-30	.....177	41244-19	.....116	41306-09	.....232, 234
33720-19	.....211	34242-14	.....324	41092-40	.....177	41245-19	.....116	41306-12	.....232
33720-21	.....211	34242-16	.....324	41092-50	.....177	41249-07	.....274	41308-00	.....234
33721-17	.....212	34242-22	.....324	41092-60	.....177	41249-10	.....274	41401-16	.....151
33722-06	.....213	34243-02	.....324	41092-70	.....177	41249-13	.....274	41405-17	.....152
33722-08	.....213	34244-10	.....324	41093-00	.....177	41249-16	.....274	41405-27	.....152
33723-17	.....212	34244-14	.....324	41094-00	.....177	41249-19	.....274	41406-01	.....153
33725-17	.....212	34244-16	.....324	41095-00	.....177	41249-22	.....274	41406-02	.....153
33727-17	.....212	34244-17	.....324	41096-21	.....178	41250-11	.....274	41420-01	.....238
33728-24	.....213	34246-00	.....324	41097-22	.....179	41250-15	.....274	41420-02	.....238
33729-24	.....213	34248-00	.....324	41098-20	.....180	41250-18	.....274	41420-03	.....238
33731-22	.....214	34250-00	.....325	41141-25	.....221	41253-07	.....274	41421-01	.....238
33733-22	.....214	34252-00	.....325	41142-19	.....221	41253-11	.....274	41421-02	.....238
33740-19	.....215	34270-00	.....325	41143-21	.....221	41253-15	.....274	41421-03	.....238
33741-18	.....215	34270-01	.....325	41146-18	.....221	41253-18	.....274	41422-01	.....238
33742-18	.....215	34280-00	.....326	41146-24	.....221	41254-06	.....275	41422-02	.....238
33743-18	.....215	34290-00	.....326	41147-21	.....222	41254-10	.....275	41422-03	.....238
33745-19	.....216	34295-00	.....326	41149-22	.....222	41254-13	.....275	41430-01	.....238
33746-19	.....216	34815-03	.....182	41151-24	.....222	41254-16	.....275	41430-02	.....238
33747-18	.....216	34815-04	.....182	41155-20	.....222	41254-19	.....275	41430-03	.....238
33748-20	.....216	34815-06	.....182	41156-18	.....223	41254-25	.....275	41431-01	.....238
33749-10	.....217	34816-13	.....181	41158-01	.....223	41254-32	.....275	41431-02	.....238
33749-13	.....217	34816-16	.....181	41158-02	.....223	41254-38	.....275	41431-03	.....238

Nummernverzeichnis  
Numerical Index  
Indice numérico  
Indice numerico



41432-01 ..... 238	41480-02 ..... 242	41520-03 ..... 286	41605-12 ..... 295	41615-50 ..... 297
41432-02 ..... 238	41480-03 ..... 242	41520-05 ..... 286	41605-12T ..... 295	41615-50T ..... 297
41432-03 ..... 238	41481-01 ..... 242	41522-03 ..... 286	41605-13 ..... 295	41615-51 ..... 297
41440-01 ..... 238	41481-02 ..... 242	41522-05 ..... 286	41605-13T ..... 295	41615-51T ..... 297
41440-02 ..... 238	41481-03 ..... 242	41524-03 ..... 286	41606-62 ..... 295	41616-79 ..... 298
41440-03 ..... 238	41482-01 ..... 242	41524-05 ..... 286	41606-62T ..... 295	41616-79T ..... 298
41441-01 ..... 238	41482-02 ..... 242	41526-03 ..... 286	41606-65 ..... 295	41616-91 ..... 298
41441-02 ..... 238	41482-03 ..... 242	41526-05 ..... 286	41606-65T ..... 295	41616-91T ..... 298
41441-03 ..... 238	41490-01 ..... 243	41527-03 ..... 286	41606-78 ..... 295	41617-10 ..... 298
41442-01 ..... 238	41490-02 ..... 243	41527-05 ..... 286	41606-78T ..... 295	41617-10T ..... 298
41442-02 ..... 238	41490-03 ..... 243	41529-03 ..... 286	41606-84 ..... 295	41617-65 ..... 298
41442-03 ..... 238	41492-01 ..... 243	41529-05 ..... 286	41606-84T ..... 295	41617-65T ..... 298
41445-25 ..... 245	41492-02 ..... 243	41540-02 ..... 284	41607-56 ..... 295	41617-72 ..... 298
41446-02 ..... 245	41492-03 ..... 243	41540-02B ..... 285	41607-56T ..... 295	41617-72T ..... 298
41446-03 ..... 245	41494-01 ..... 243	41540-03 ..... 284	41607-57 ..... 295	41617-78 ..... 298
41446-09 ..... 245	41494-02 ..... 243	41540-03B ..... 285	41607-57T ..... 295	41617-78T ..... 298
41448-02 ..... 239	41494-03 ..... 243	41540-04 ..... 284	41607-58 ..... 295	41618-55 ..... 298
41448-03 ..... 239	41496-01 ..... 243	41540-04B ..... 285	41607-58T ..... 295	41618-55T ..... 298
41448-04 ..... 239	41496-02 ..... 243	41540-05 ..... 284	41607-59 ..... 295	41618-56 ..... 298
41449-01 ..... 239	41496-03 ..... 243	41540-05B ..... 285	41607-59T ..... 295	41618-56T ..... 298
41449-02 ..... 239	41510-01 ..... 282	41542-02 ..... 284	41607-60 ..... 295	41618-57 ..... 298
41449-03 ..... 239	41510-01B ..... 283	41542-02B ..... 285	41607-60T ..... 295	41618-57T ..... 298
41450-00 ..... 240	41510-02 ..... 282	41542-03 ..... 284	41607-72 ..... 295	41618-79 ..... 298
41451-01 ..... 241	41510-02B ..... 283	41542-03B ..... 285	41607-72T ..... 295	41618-79T ..... 298
41451-02 ..... 241	41510-03 ..... 282	41542-04 ..... 284	41607-73 ..... 295	41618-88 ..... 298
41451-03 ..... 241	41510-03B ..... 283	41542-04B ..... 285	41607-73T ..... 295	41618-88T ..... 298
41452-01 ..... 241	41510-04 ..... 282	41542-05 ..... 284	41607-82 ..... 295	41619-00 ..... 298
41452-02 ..... 241	41510-04B ..... 283	41542-05B ..... 285	41607-82T ..... 295	41619-00T ..... 298
41452-03 ..... 241	41510-05 ..... 282	41600-62 ..... 294	41608-57 ..... 295	41620-58 ..... 299
41453-01 ..... 241	41510-05B ..... 283	41600-62T ..... 294	41608-57T ..... 295	41620-58T ..... 299
41453-02 ..... 241	41511-01 ..... 282	41600-70 ..... 294	41608-80 ..... 295	41620-59 ..... 299
41453-03 ..... 241	41511-02 ..... 282	41600-70T ..... 294	41608-80T ..... 295	41620-59T ..... 299
41458-20 ..... 241	41511-03 ..... 282	41600-78 ..... 294	41609-70 ..... 295	41620-60 ..... 299
41460-01 ..... 242	41511-04 ..... 282	41600-78T ..... 294	41609-70T ..... 295	41620-60T ..... 299
41460-02 ..... 242	41511-05 ..... 282	41600-92 ..... 294	41610-61 ..... 296	41620-61 ..... 299
41460-03 ..... 242	41512-01 ..... 282	41600-92T ..... 294	41610-61T ..... 296	41620-61T ..... 299
41461-01 ..... 242	41512-01B ..... 283	41601-10 ..... 294	41610-68 ..... 296	41620-62 ..... 299
41461-02 ..... 242	41512-02 ..... 282	41601-10T ..... 294	41610-68T ..... 296	41620-62T ..... 299
41461-03 ..... 242	41512-02B ..... 283	41601-11 ..... 294	41610-70 ..... 296	41620-63 ..... 299
41462-01 ..... 242	41512-03 ..... 282	41601-11T ..... 294	41610-70T ..... 296	41620-63T ..... 299
41462-02 ..... 242	41512-03B ..... 283	41601-13 ..... 294	41611-74 ..... 296	41620-70 ..... 299
41462-03 ..... 242	41512-04 ..... 282	41601-13T ..... 294	41611-74T ..... 296	41620-70T ..... 299
41465-01 ..... 242	41512-04B ..... 283	41602-60 ..... 294	41611-87 ..... 296	41620-78 ..... 299
41465-02 ..... 242	41512-05 ..... 282	41602-60T ..... 294	41611-87T ..... 296	41620-78T ..... 299
41465-03 ..... 242	41512-05B ..... 283	41602-68 ..... 294	41611-92 ..... 296	41620-88 ..... 299
41466-01 ..... 242	41513-01 ..... 282	41602-68T ..... 294	41611-92T ..... 296	41620-88T ..... 299
41466-02 ..... 242	41513-01B ..... 283	41602-75 ..... 294	41612-07 ..... 296	41621-58 ..... 299
41466-03 ..... 242	41513-02 ..... 282	41602-75T ..... 294	41612-07T ..... 296	41621-58T ..... 299
41467-01 ..... 242	41513-02B ..... 283	41602-87 ..... 294	41612-09 ..... 296	41621-62 ..... 299
41467-02 ..... 242	41513-03 ..... 282	41602-87T ..... 294	41612-09T ..... 296	41621-62T ..... 299
41467-03 ..... 242	41513-03B ..... 283	41603-55 ..... 294	41612-11 ..... 296	41622-58 ..... 299
41470-01 ..... 242	41513-04 ..... 282	41603-55T ..... 294	41612-11T ..... 296	41622-58T ..... 299
41470-02 ..... 242	41513-04B ..... 283	41603-61 ..... 294	41612-12 ..... 296	41622-62 ..... 299
41470-03 ..... 242	41513-05 ..... 282	41603-61T ..... 294	41612-12T ..... 296	41622-62T ..... 299
41471-01 ..... 242	41513-05B ..... 283	41603-65 ..... 294	41612-62 ..... 296	41623-56 ..... 299
41471-02 ..... 242	41514-01 ..... 282	41603-65T ..... 294	41612-62T ..... 296	41623-56T ..... 299
41471-03 ..... 242	41514-02 ..... 282	41603-74 ..... 294	41613-74 ..... 297	41624-56 ..... 299
41472-01 ..... 242	41514-03 ..... 282	41603-74T ..... 294	41613-74T ..... 297	41624-56T ..... 299
41472-02 ..... 242	41514-04 ..... 282	41604-54 ..... 294	41613-84 ..... 297	41625-56 ..... 299
41472-03 ..... 242	41514-05 ..... 282	41604-54T ..... 294	41613-84T ..... 297	41625-56T ..... 299
41475-01 ..... 242	41515-01 ..... 282	41604-58 ..... 294	41613-96 ..... 297	41626-56 ..... 299
41475-02 ..... 242	41515-01B ..... 283	41604-58T ..... 294	41613-96T ..... 297	41626-56T ..... 299
41475-03 ..... 242	41515-02 ..... 282	41604-62 ..... 294	41614-58 ..... 297	41627-33 ..... 300
41476-01 ..... 242	41515-02B ..... 283	41604-62T ..... 294	41614-58T ..... 297	41627-33T ..... 300
41476-02 ..... 242	41515-03 ..... 282	41604-79 ..... 294	41614-65 ..... 297	41627-40 ..... 300
41476-03 ..... 242	41515-03B ..... 283	41604-79T ..... 294	41614-65T ..... 297	41627-40T ..... 300
41477-01 ..... 242	41515-04 ..... 282	41604-87 ..... 294	41614-72 ..... 297	41628-33 ..... 300
41477-02 ..... 242	41515-04B ..... 283	41604-87T ..... 294	41614-72T ..... 297	41628-33T ..... 300
41477-03 ..... 242	41515-05 ..... 282	41605-10 ..... 295	41615-49 ..... 297	41628-40 ..... 300
41480-01 ..... 242	41515-05B ..... 283	41605-10T ..... 295	41615-49T ..... 297	41628-40T ..... 300





Nummernverzeichnis  
Numerical Index  
Indice numérico  
Indice numerico

41628-46	300	41649-11	304	41711-11	315	41801-01	276	57141-36	48
41628-46T	300	41650-07	304	41711-17	315	41802-00	279	57262-00	139
41629-32	300	41650-09	304	41712-08	315	41802-02	276	61460-15	319
41629-32T	300	41650-11	304	41712-11	315	41803-01	278	61460-19	319
41629-38	300	41651-07	304	41712-17	315	41807-00	278	61461-15	319
41629-38T	300	41651-09	304	41713-08	315	41810-10	276, 278, 279	61461-19	319
41630-36	300	41651-11	304	41713-11	315	41821-21	277, 278	61461-28	320
41630-36T	300	41652-07	304	41713-17	315	41822-22	276, 277	61462-19	319
41630-38	300	41652-09	304	41714-08	315	41826-26	276, 277	61462-28	320
41630-38T	300	41652-11	304	41714-11	315	41830-30	276, 277, 279	61463-19	319
41631-36	300	41653-18	305	41714-17	315	41832-32	277	61463-28	320
41631-36T	300	41654-18	305	41715-08	315	41842-42	279, 280	61464-15	319
41631-40	300	41655-18	305	41715-11	315	41842-44	280	61464-19	319
41631-40T	300	41656-18	305	41715-17	315	41842-46	280	61464-28	320
41631-44	300	41657-17	305	41716-08	315	41843-50	279, 280	61465-15	319
41631-44T	300	41657-21	305	41716-11	315	41850-41	279, 280	61465-19	319
41632-36	300	41657-23	305	41716-17	315	41860-14	275	61465-28	320
41632-36T	300	41658-17	305	41717-08	315	41860-17	275	61466-15	319
41633-35	300	41658-21	305	41717-11	315	41860-20	275	61466-19	319
41633-35T	300	41658-23	305	41717-17	315	41870-08	275	61466-28	320
41633-40	300	41659-17	305	41718-25	315	41870-11	275	61467-15	319
41633-40T	300	41659-21	305	41718-36	315	41870-14	275	61467-19	319
41634-35	300	41659-23	305	41719-25	315	41870-17	275	61467-28	320
41634-35T	300	41660-17	305	41719-36	315	41880-01	275, 279	61468-19	319
41634-60	300	41660-21	305	41720-25	315	41880-02	275, 279	61468-28	320
41634-60T	300	41660-23	305	41720-36	315	41880-03	275	61469-19	319
41634-70	300	41661-40	306	41721-25	315	45075-00	11	61469-28	320
41634-70T	300	41661-50	306	41721-36	315	45206-14	74	61470-15	319
41635-57	300	41662-50	306	41722-08	316	45206-16	74	61470-19	319
41635-57T	300	41663-01	306, 308, 309	41722-11	316	45208-14	74	61471-15	319
41636-45	300	41663-02	306, 308, 309	41722-14	316	47154-20	74	61471-19	319
41636-45T	300	41664-10	307	41722-17	316	47155-20	74	61471-28	320
41637-33	301	41664-14	307	41722-23	316	47223-01	244	61472-19	319
41637-33T	301	41665-10	307	41723-08	316	47223-02	244	61472-28	320
41637-40	301	41665-14	307	41723-11	316	47223-03	244	61473-19	319
41637-40T	301	41666-00	307	41723-14	316	47223-04	244	61473-28	320
41638-38	301	41667-30	308	41723-17	316	47223-05	244	61481-15	319
41638-38T	301	41667-50	308	41723-23	316	47224-01	244	61481-19	319
41638-46	301	41668-50	308	41724-08	317	47224-02	244	61482-15	319
41638-46T	301	41669-50	308	41724-11	317	47224-03	244	61482-19	319
41639-44	301	41670-50	308	41724-14	317	47224-04	244	61482-28	320
41639-44T	301	41672-01	309	41724-17	317	47224-05	244	61483-19	319
41640-40	301	41672-02	309	41724-23	317	47303-03	287	61483-28	320
41640-40T	301	41672-03	309	41725-08	317	47303-04	287	61484-19	319
41641-07	302	41672-04	309	41725-11	317	47303-05	287	61484-28	320
41641-09	302	41674-50	310	41725-14	317	47303-06	287	91104-11	328
41641-11	302	41674-80	310	41725-17	317	47304-01	287	91109-11	328
41642-07	302	41675-50	310	41725-23	317	47304-02	287	91110-03N	332
41642-09	302	41675-80	310	41726-08	316	47304-03	287	91110-05N	332
41642-11	302	41676-50	310	41726-11	316	47304-04	287	91110-10N	332
41643-07	302	41676-80	310	41726-14	316	47311-10	288	91112-03N	332
41643-09	302	41677-50	310	41726-17	316	47311-25	288	91112-05N	332
41643-11	302	41677-80	310	41726-23	316	47311-30	288	91112-10N	332
41644-07	302	41678-50	310	41727-08	316	47316-16	288	91113-11	328
41644-09	302	41678-80	310	41727-11	316	47347-20	235	91122-16	328
41644-11	302	41679-00	312	41727-14	316	47411-16	219	91123-16	328
41645-07	303	41679-01	312	41727-17	316	47412-20	219	91125-16	328
41645-09	303	41679-25	311	41727-23	316	47413-19	220	91142-16	329
41645-11	303	41680-00	311	41728-08	317	47415-18	220	91144-16	329
41646-07	303	41690-00	312	41728-11	317	47417-19	220	91152-19	329
41646-09	303	41690-01	312	41728-14	317	47419-19	220	91154-19	329
41646-11	303	41700-01	313	41728-17	317	47454-04	204	91157-19	329
41647-07	303	41700-02	313	41728-23	317	47454-07	204	91159-19	329
41647-09	303	41700-03	314	41729-08	317	47454-09	204	91160-03N	332
41647-11	303	41700-04	314	41729-11	317	47454-12	204	91160-05N	332
41648-07	303	41700-05	314	41729-14	317	47558-15	102	91160-10N	332
41648-09	303	41710-08	315	41729-17	317	47560-18	102	91160-20N	332
41648-11	303	41710-11	315	41729-23	317	47562-18	102	91162-05N	332
41649-07	304	41710-17	315	41730-15	318	57131-26	48	91162-10N	332
41649-09	304	41711-08	315	41731-15	318	57137-27	48	91162-19	330



Nummernverzeichnis  
Numerical Index  
Indice numérico  
Indice numerico



91164-19	330	93107-22	42	93292-20	75	93462-20	251	93690-01	267
91166-03N	333	93108-22	42	93292-22	75	93462-23	251	93700-03	268
91166-05N	333	93109-22	42	93292-24	75	93463-20	251	93700-05	268
91166-10N	333	93111-20	43	93294-18	75	93463-23	251	93701-03	268
91166-19	331	93113-20	43	93300-22	72	93464-20	251	93701-05	268
91166-20N	333	93115-19	43	93300-24	72	93464-23	251	93702-03	268
91168-05N	333	93170-16	99	93302-22	72	93465-20	251	93702-05	268
91168-10N	333	93170-18	99	93302-24	72	93465-23	251	93703-03	268
91172-03	331	93171-16	99	93304-24	72	93466-20	251	93703-05	268
91172-07	331	93171-18	99	93306-22	72	93466-23	251	93704-24	269
91172-12	331	93180-12	44	93308-22	72	93467-20	251	93705-00	269
91180-05N	332	93180-16	44	93310-22	72	93467-23	251	93710-01	270
91180-10N	332	93180-18	44	93312-22	72	93470-20	252	93710-02	270
91180-20N	332	93181-12	44	93321-23	73	93470-23	252	93710-03	270
91182-10N	332	93181-16	44	93323-23	73	93471-20	252	93710-04	270
91182-20N	332	93181-18	44	93325-23	73	93471-23	252	93710-05	270
91190-30	335	93182-16	44	93327-23	73	93472-20	252	93710-06	270
91190-50	335	93183-16	44	93329-23	73	93472-23	252	93710-07	270
91192-30	335	93190-12	44	93331-23	73	93473-20	252	93720-01	271
91192-50	335	93190-16	44	93340-15	63	93473-23	252	93720-02	271
91193-30	335	93191-12	44	93342-15	63	93474-23	252	93720-03	271
91193-50	335	93191-16	44	93342-18	63	93475-23	252	93720-04	271
91200-05N	332	93192-13	44	93350-12	64	93480-23	227	93730-04	272
91200-10N	332	93193-12	44	93350-13	64	93481-20	227	93730-06	272
91200-20N	332	93195-18	44	93351-13	64	93482-23	227	93731-04	272
91201-20 S	334	93200-16	100	93360-09	64	93483-23	227	93740-01	272
91202-05N	332	93200-18	100	93370-14	64	93484-23	227	93740-02	272
91202-10N	332	93201-16	100	93370-18	64	93485-18	227	93750-01	272
91202-20N	332	93201-18	100	93380-13	16	93486-21	227	93750-02	272
91206-05N	333	93210-12	45	93380-15	16	93487-18	227	93750-03	272
91206-10N	333	93210-16	45	93380-18	16	93490-01	228	93750-04	272
91206-20N	333	93210-18	45	93380-20	16	93490-02	228	93755-14	47
91207-10N	333	93211-12	45	93385-21	16	93490-03	228	93756-14	47
91208-10N	333	93211-16	45	93385-25	16	93490-04	228	93757-14	47
91220-10N	332	93211-18	45	93390-21	16	93490-05	228		
91220-20N	332	93212-16	45	93400-01	115	93490-06	228		
91222-10N	332	93213-16	45	93400-02	115	93500-18	253		
91222-20N	332	93216-12	45	93401-01	115	93501-23	253		
91226-05N	333	93216-16	45	93401-02	115	93505-01	254		
91226-10N	333	93217-12	45	93402-01	115	93505-02	254		
91226-20N	333	93217-16	45	93402-02	115	93505-03	254		
91227-10N	333	93218-13	45	93403-01	115	93505-04	254		
91228-10N	333	93219-12	45	93403-02	115	93506-05	257		
91240-10N	332	93221-18	45	93405-01	116	93506-08	257		
91242-10N	332	93250-15T	96	93405-02	116	93510-18	255		
91246-05N	333	93250-18T	96	93405-03	116	93600-01	263		
91246-10N	333	93250-21T	96	93405-04	116	93600-02	263		
91246-20N	333	93251-15T	96	93410-01	225	93600-03	263		
91300-10N	332	93251-18T	96	93410-02	225	93605-21	263		
91300-20N	332	93251-21T	96	93410-03	225	93610-11	264		
91302-10N	332	93260-15T	96	93410-05	225	93610-13	264		
93092-20	98	93260-18T	96	93410-06	225	93610-15	264		
93092-22	98	93260-21T	96	93410-07	225	93615-01	264		
93093-16	98	93261-15T	96	93420-01	226	93620-14	264		
93093-20	98	93261-18T	96	93420-02	226	93660-01	265		
93093-22	98	93261-21T	96	93420-03	226	93660-02	265		
93093-24	98	93270-14	46	93420-04	226	93660-03	265		
93094-16	41	93270-18	46	93430-01	193	93660-04	265		
93094-20	41	93270-23	46	93430-02	193	93670-01	266		
93095-16	41	93271-14	46	93430-03	193	93670-02	266		
93095-20	41	93271-18	46	93440-01	117	93670-05	266		
93097-20	41	93273-14	46	93440-02	117	93670-06	266		
93098-20	41	93273-18	46	93440-03	117	93670-09	266		
93099-20	41	93290-16	75	93450-01	118	93670-10	266		
93100-22	42	93290-18	75	93450-02	118	93670-12	266		
93101-22	42	93290-20	75	93450-04	118	93680-01	267		
93102-22	42	93290-22	75	93460-20	251	93680-02	267		
93103-22	42	93290-24	75	93460-23	251	93680-05	267		
93103-24	42	93292-16	75	93461-20	251	93680-06	267		
93105-22	42	93292-18	75	93461-23	251	93680-07	267		



Wondershare  
PDFelement

ALPHABETISCHER INDEX

ALPHABETICAL INDEX

INDEX ALPHABÉTICO

INDICE ALFABETICO

**HADEO**  
INSTRUMENTE GERMANY

[www.hadeo.co](http://www.hadeo.co)

<b>A</b>	<b>B</b>	<b>C</b>
AACHEN, Hirnspatel.....274	BABINSKY, Perkussionshammer.....8	CAROLL, Sehnenfaßzange.....92
ACLAND, Clip-Anlegepinzette.....318	BACON, Hohlmeißelzange.....166	CASPAR, Blätter.....136
ACLAND, Mikro-Gefäßclip, Arterie + Vene.....315 - 317	BADGLEY, Laminektomie-Spreizer.....139	CASPAR, Cervicalspreizer.....144, 154
Adapter, HOUSE.....231	Bandscheibenstanze, COLCLOUGH.....286	CASPAR, Distraktor.....158
ADLERKREUTZ, Gefäßpinzette.....54	Bandscheibenstanze, FERRIS-SMITH-KERRISON.....282 - 285	CASPAR, Einsetzinstrument.....194
ADSON, anatomische Pinzette.....51	BANE-HARTMANN, Hohlmeißelzange.....164	CASPAR, Explorationshäkchen.....115
ADSON, Bohrlochzange.....181	BARON, Saugrohr.....231	CASPAR, Fadengabel.....253
ADSON, chirurgische Pinzette.....51, 52	BARRAQUER, Nadelhalter.....96	CASPAR, Gegensperrler.....156
ADSON, Dura-Haken.....110	BAUMGARTNER, Nadelhalter.....94	CASPAR, Haken.....136
ADSON, Hohlmeißelzange.....163	BECKMANN, Wundspreizer.....132	CASPAR, Knochenspanhalter.....194
ADSON, Hypophyse-Pinzette.....261	BECKMANN-ADSON (CONE), Wundspreizer.....126	CASPAR, Koagulationshäkchen.....115
ADSON, Raspatorium.....218	BECKMANN-ADSON, Wundspreizer.....130	CASPAR, Laminektomie-Spreizer.....136
ADSON, Saugrohr.....230	BECKMANN-EATON, Wundspreizer.....132	CASPAR, Laminektomie-Zange.....242, 243
ADSON, Wundspreizer.....125, 126, 129	BERCHTOLD, Bipolar-Verbindungskabel.....335	CASPAR, Lumbal-Wundspreizer.....154, 156
ADSON-BABY, Arterienklemme.....88	BERLINER, Perkussionshammer.....8	CASPAR, Mikro-Dissektor.....227, 228
ADSON-BROWN, chirurgische Pinzette.....52	BEYER, Hohlmeißelzange.....165, 167	CASPAR, Nervwurzelhaken.....112
ADSON-De BAKEY, Atrauma-Pinzette.....51	BIEMER, Anlegepinzette.....306, 311	CASPAR, Skalpellgriff.....16
AESCULAP, Bipolar-Verbindungskabel.....335	BIEMER, Approximator.....311	CASPAR, Spekula.....155
ALEXANDER, Raspatorium.....210	BIEMER, Gefäßclip.....306	CASPAR, Stößel.....195
ALM, Wundspreizer.....120	BIEMER, Gefäßspreizer.....250	CASTROVIEJO, Hornhautschee.....36
Anatomische Mikro-Pinzette.....56	BIEMER, Nerv-Approximator.....312	CASTROVIEJO, Klingenspreizer.....17
Anatomische Pinzette, ADSON.....51	BIEMER, Venenscherer.....44, 45	CASTROVIEJO, Nadelhalter.....97
Anatomische Pinzette, BROPHY.....54	BIEMER-MÜLLER, Approximator.....308	Cervicalgewebespreizer, CLOWARD.....153
Anatomische Pinzette, CUSHING.....53	Biopsie-Bohrer, MICHELE.....182	Chirurgische Pinzette, ADSON.....51, 52
Anatomische Pinzette, DUEHRSEN.....55	Bipolare Pinzette.....328 - 331	Chirurgische Pinzette, BROPHY.....54
Anatomische Pinzette, GERALD.....56, 57	Bipolare Saugpinzette.....334	Chirurgische Pinzette, CUSHING.....53
Anatomische Pinzette, Mc INDOE.....55	Bipolares Verbindungskabel.....335	Chirurgische Pinzette, GERALD.....57
Anatomische Pinzette, POTTS-SMITH.....50	Bipolar-Pinzette, Antihäuft.....332, 333	Chirurgische Pinzette, GILLIES.....56
Anatomische Pinzette, SEMKEN.....56	BLACK, Präparierschere.....25	Chirurgische Pinzette, Mc INDOE.....55
Anatomische Pinzette, TAYLOR.....58	Blätter, CASPAR.....136	Chirurgische Pinzette, POTTS-SMITH.....50
ANDERSON-ADSON, Wundspreizer.....128	Blätter, medial, lateral.....146	Chirurgische Pinzette, SEMKEN.....56
Aneurysmen-Gefäßclip, YASARGIL.....294 - 301	Blätter, schwarz.....154, 156, 157	Chirurgische Pinzette, TAYLOR.....58
Anlegepinzette, ACLAND.....318	Blätter, Titan.....145, 146	Chirurgische Pinzette, WAUGH.....53
Anlegepinzette, BIEMER.....306, 311	Blätter-Wechselpinzette.....144, 156	Chirurgische Pinzette, ADSON-BROWN.....52
Anlegepinzette, MEHDORN.....307	Blattretractor, CLOWARD.....103	Chirurgische Schere, IRIS.....27
Anlegezange f. Bulldogklemmen.....83	BÖHLER, Hohlmeißelzange.....167	Chirurgische Schere, Neuro.....27
Anlegezange f. offene Chirurgie.....319, 320	BÖHLER, Knochensplitterzange.....172	Chirurgische Scheren, Standard.....20
Anlegezange, Mc KENZIE.....174	Bohrapparat, BUNELL.....325	CITELLI, Stanze.....288
Anlegezange, MINI.....302 - 305	Bohrapparat, HUDSON.....324	Clip-Anlegezange.....319, 320
Anlegezange, OLIVECRONA-TOENNIS.....174	Bohrapparat, KIRSCHNER.....325	Clip, ACLAND.....315 - 317
Anlegezange, SMITHWICK.....174	Bohrapparat, MOORE.....323	Clip, BIEMER.....306
Anlegezange, STANDARD.....302 - 305	Bohrapparat, RALK.....326	Clip, MEHDORN.....307
Anlegezange, SWEET.....174	Bohrapparat, HADEO.....326	Clip, MÜLLER.....310, 311
Antihäuft Bipolarpinzette.....332, 333	Bohrapparat, STILLE.....322	CLOWARD, Blattretractor.....103
Approximator, BIEMER.....311, 312	Bohrapparat, STILLE-SHERMAN.....323	CLOWARD, Cervical-Spreizer.....140 - 143
Approximator, BIEMER-MÜLLER.....308	Bohrer.....160	CLOWARD, Lamina-Spreizer.....151, 153
Approximator, MÜLLER.....309	Bohrer f. HJUNSON.....324	CLOWARD, Laminektomie-Zange.....239
Arterienklemme, ADSON-BABY.....88	Bohrer f. MOORE.....323	CLOWARD, Sperrler.....140 - 143
Arterienklemme, CRILE.....85	Bohrer f. STILLE.....322	CLOWARD, Wirbelkörper-Spreizer.....153
Arterienklemme, CRILE-RANKIN.....85	Bohrer f. STILLE-SHERMAN.....323	COBB, Hohlmeißel.....200
Arterienklemme, DANDY.....86	Bohrer, CRUTCHFIELD.....176	COBB, Kürette.....185
Arterienklemme, FUCHSIG.....88	Bohrer, CUSHING.....324	COBB, Raspatorium.....217
Arterienklemme, GEMINI.....89	Bohrer, ERRICO.....324	COLCLOUGH, Bandscheibenstanze.....286
Arterienklemme, HALSTED-MOSQUITO.....84	Bohrer, Mc KENZIE.....324	CONE, Ringkürette.....260
Arterienklemme, HARTMANN.....83	Bohrer, MICHELE.....182	CONE, Schädelstanze.....179
Arterienklemme, JACOBSON.....84	Bohrlehre.....159	CONE, Wundspreizer.....126
Arterienklemme, KELLY.....85	Bohrloch-Schutzzange.....180	Container f. Aneurysmenclips.....313, 314
Arterienklemme, KELLY-RANKIN.....85	Bohrlochzange, ADSON.....181	COTTLE, Fixierpinzette.....74
Arterienklemme, MIXTER-BABY.....90	Bohrstütze f. KIRSCHNER.....325	COTTLE, Osteotom.....204
Atrauma-Bulldogklemme.....80	BOIES, Elevatorium.....211	COTTLE, Stahlhammer.....10
Atrauma-Bulldogklemme, De BAKEY.....80 - 82	BROPHY, anatomische Pinzette.....54	COTTLE-KAZANJIAN, Knochensplitterzange.....172
Atrauma-Bulldogklemme, De BAKEY (CAROTID).....82	BROPHY, chirurgische Pinzette.....54	CRILE, Arterienklemme.....85
Atrauma-Bulldogklemme, De BAKEY (SATINSKY).....82	BROWN, Gewebefäßpinzette.....53	CRILE, Nervhaken.....109
Atrauma-Bulldogklemme, De BAKEY-HESS.....82	BRUNS, scharfer Löffel.....188	CRILE-RANKIN, Arterienklemme.....85
Atrauma-Bulldogklemme, GLOVER.....80, 81	BUCK, Perkussionshammer.....8	CRILE-WOOD, Nadelhalter.....94
Atrauma-Bulldogklemme, Titan.....79	Bulldogklemme, atrauma.....80	CRUTCHFIELD, Bohrer.....176
Atrauma-Mikro-Pinzette, De BAKEY.....67, 68	Bulldogklemme, De BAKEY (CAROTID), atrauma.....82	CRUTCHFIELD, Schädelhalter.....176
Atrauma-Pinzette, ADSON-De BAKEY.....51	Bulldogklemme, De BAKEY (SATINSKY), atrauma.....82	CUSHING (LITTLE-JOKER), Raspatorium.....207
Atrauma-Pinzette, De BAKEY.....69	Bulldogklemme, De BAKEY, atrauma.....80 - 82	CUSHING (TAYLOR)anatomische Pinzette.....57
Atrauma-Ultra-Light-Pinzette.....65	Bulldogklemme, De BAKEY-DIETRICH.....78	CUSHING, anatomische Pinzette.....53
AUSTIN, Mikro-Knüpfpinzette.....64	Bulldogklemme, De BAKEY-HESS, atrauma.....82	CUSHING, chirurgische Pinzette.....53
	Bulldogklemme, DIEFFENBACH.....83	CUSHING, Flachbohrer.....324
	Bulldogklemme, DIETRICH.....78	CUSHING, Hirnspatel.....274, 279
	Bulldogklemme, GLOVER, atrauma.....80, 81	CUSHING, Laminektomie-Zange.....238
	Bulldogklemme, JOHNS-HOPKINS.....83	CUSHING, Nervhaken.....109
	Bulldogklemme, Titan, atrauma.....79	CUSHING, Raspatorium.....208
	BUNELL, Handbohrapparat.....325	CUSHING, Wundhaken.....103
	BUSHE, scharfer Löffel.....191	CUSHING-LANDOLT, Spekula.....263

## Index Deutsch

**HADEO**  
 INSTRUMENTE GERMANY

<b>D</b>		<b>E</b>		<b>G</b>	
DANDY, Arterienklemme.....	86	ECHLIN, Hohlmeißelzange.....	171	Galeahaken, YASARGIL.....	114
DANDY, Nervhaken.....	108	Einsetzinstrument, CASPAR.....	194	GALT, Schädeltrephine.....	181
DANDY, Trigemini-Schere.....	33	Elevator m. Hohlheft.....	213	Gefäßclip, ACLAND.....	315 - 317
DARLING, Hemilanektomie-Spreizer.....	147	Elevatorium, BOIES.....	211	Gefäßclip, BIEMER.....	306
DAUBENSPECK, scharfer Löffel.....	189	Elevatorium, Ferrozellgriff.....	215, 216	Gefäßclip, MEHDORN.....	307
DAVIS, Dura-Dissektor.....	221, 222	Elevatorium, FREER.....	220	Gefäßclip, YASARGIL.....	294 - 301
DAVIS, Himspatel.....	275	Elevatorium, JOSEPH.....	219	Gefäßclip, MÜLLER.....	309 - 311
De BAKEY (CAROTID), Atrauma-Bulldogklemme.....	82	Elevatorium, KEY.....	218	Gefäßdilator.....	61, 250
De BAKEY (SATINSKY) Atrauma-Bulldogklemme.....	82	Elevatorium, Mc DONALD.....	219	Gefäßmesser, JACOBSON.....	117, 118
De BAKEY, Atrauma-Bulldogklemme.....	80 - 82	Elevatorium, QUERVAIN.....	208	Gefäßmesser, KOOS.....	248, 249
De BAKEY, Atrauma-Mikro-Pinzette.....	67, 68	Elevatorium, ROGER.....	220	Gefäßmesser, Mikro.....	118
De BAKEY, Atrauma-Pinzette.....	69	Elevatorium, SEBILEAU.....	208	Gefäßmesser, YASARGIL.....	248
De BAKEY, Gefäßschere.....	30 - 32	Elevatorium, SEWALL.....	219	Gefäßpinzette, ADLERKREUZ.....	54
De BAKEY, Nadelhalter TC.....	95	Elevatorium, WATSON-CHEYNE.....	219	Gefäßpinzette, WANGENSTEEN.....	58
De BAKEY-DIETRICH, Atrauma-Bulldogklemme.....	78	Erukleator, HARDY.....	266	Gefäßschere, De Bakay.....	30 - 32
De BAKEY-HESS, Atrauma-Bulldogklemme.....	82	Erukleator, LANDOLT.....	267	Gefäßschere, DIETRICH.....	29, 30
De MARTEL, Führungsinstrument.....	177	ERBE, Bipolar-Verbindungskabel.....	335	Gefäßschere, FAVALORO.....	32
De VILBISS, Schädelzange.....	178	ERRICO, Bohrer.....	324	Gefäßschere, KELLY.....	21
DEAVER, Präparierschere.....	21	Ersatzbacken.....	9, 10	Gefäßschere, MILLS.....	29
DEJERINE, Perkussionshammer.....	8	Ersatz-Nadeln f. Approximator.....	312	Gefäßschere, POTTS-De MARTEL.....	29
D'ERRICO, Nervwundhaken.....	113	Ersatzschlüssel f. Approximator.....	312	Gefäßschere, POTTS-SMITH.....	30, 31
Diamantiert, Ringpinzette.....	66	Explorationshäkchen, CASPAR.....	115	Gefäßspreizer, BIEMER.....	250
DIEFFENBACH, Bulldogklemme.....	83			Gegenspreizer, CASPAR.....	156
DIETRICH, Gefäßschere.....	29, 30	<b>F</b>		Gelenkkloben, LEYLA.....	279, 280
DIETRICH, Mini-Bulldogklemme.....	78	Fadenführer, YASARGIL.....	116	GELPI, Wundspreizer.....	150
Dilatator.....	61	Fadengabel, CASPAR.....	253	GEMINI, Arterienklemme.....	89
Dilatator, Gefäß.....	250	Fadengabel, JACOBSON.....	253	GERALD, anatomische Pinzette.....	56, 57
Dissektor.....	222	FAHLBUSCH, Kürette.....	270	GERALD, chirurgische Pinzette.....	57
Dissektor, CASPAR.....	227, 228	FAHLBUSCH, Löffel.....	270	Gewebeclippinzette, BROWN.....	53
Dissektor, DAVIS.....	221, 222	FAHLBUSCH, Mikro-Schere.....	271	Gewebebrücke.....	255
Dissektor, FRAZIER.....	223	FARABEUF, Raspatorium.....	206	GIERTZ-STILLE, Rippenscheere.....	48
Dissektor, GORNEY.....	211	FARABEUF-COLLIN, Raspatorium.....	206, 207	GIGLI, Drahtsäge-Handgriff.....	177
Dissektor, HARDY-FAHLBUSCH.....	266	Faßzange, MARTEL.....	87	GIGLI-STRULLY, Drahtsäge-Handgriff.....	177
Dissektor, HOEN.....	223	Faßzange, WILLET-MARTEL.....	87	GILLIES, chirurgische Pinzette.....	56
Dissektor, HORSLEY.....	222	Faßzange, YASARGIL-NICOLA.....	271	GILLIES, Hauthäkchen.....	102
Dissektor, LANDOLT-REULEN.....	270	FAVALORO, Gefäßschere.....	32	GLOVER, Atrauma-Bulldogklemme.....	80, 81
Dissektor, Mikro.....	227, 228	Federschere, Mikro.....	35, 38 - 45	GORNEY, Dissektor.....	211
Dissektor, MILLIGAN.....	222	FERRIS-SMITH, Laminektomie-Zange.....	241	GRADLE, Ophthalmologie-Schere.....	28
Dissektor, OLIVECRONA.....	221	FERRIS-SMITH-KERRISON, Bandscheibenstanze.....	282 - 285	GRAHAM, Nervhaken.....	110
Dissektor, PENFIELD.....	224	FISCH, Dura-Haken.....	249	Griff f. HUDSON.....	324
Dissektor, RHOTON.....	256	FISCH, feines Häkchen.....	118	Griff mit Spannutter.....	117
Dissektor, SACHS.....	221	Fixierpinzette, COTTLE.....	74	Griff, CASPAR.....	16
Dissektor, TOENNIS.....	221	Fixiervorrichtung, LEYLA.....	276, 278, 279	Griff, LANDOLT.....	16
Dissektor, WOODSON.....	223	Flachbohrer, CUSHING.....	324	GUILLEN, Saugraspatorium.....	235
Distractionsschraube.....	160	Flachmeißel, Ferrozellgriff.....	202		
Distraktor, CASPAR.....	158	Flachmeißel, STILLE.....	196	<b>H</b>	
Doppellöffel, JANSEN.....	192	flexibler Spannarm, LEYLA.....	276, 278, 279	HAJEK-KOFLER, Stanze.....	287, 288
Doppellöffel, VOLKMANN.....	192	flexibler Spannarm, YASARGIL.....	278	Häkchen, auswechselbar.....	117
Doppelsonde, JACOBSON.....	249	FOMON, Raspatorium.....	211	Häkchen, CASPAR.....	115
DOYEN, Raspatorium.....	212, 213	Fräser f. HUDSON.....	324	Häkchen, FISCH.....	118
Drahtsäge, OLIVECRONA.....	177	Fräser f. STILLE.....	322	Häkchen, FRAZIER.....	102
Drahtsägegriff, GIGLI.....	177	FRAZIER, Dura-Dissektor.....	223	Häkchen, FREER.....	102
Drahtsägegriff, GIGLI-STRULLY.....	177	FRAZIER, Hauthäkchen.....	102	Häkchen, GILLIES.....	102
Drahtsägegriff, HADEO.....	177	FRAZIER, Saugrohr.....	230	Häkchen, JOSEPH.....	102
Drahtsägegriff, STRULLY.....	177	FRAZIER/FERGUSSON, Punktionskanüle.....	231	Häkchen, KRAYENBÜHL.....	116
Drahtschere, UNIVERSAL.....	34	FRAZIER/FERGUSSON, Saugrohr.....	231	Häkchen, LANDOLT.....	267
Dreh Schlüssel f. CASPAR.....	136	FREER, Hauthäkchen.....	102	Häkchen, LANDOLT-REULEN.....	270
DUEHRSEN, anatomische Pinzette.....	55	FREER, Septumelevator.....	220	Häkchen, Mikro.....	118
Dura-Dissektor.....	222	FRIEDMAN, Hohlmeißelzange.....	162	Häkchen, RHOTON.....	256
Dura-Dissektor, DAVIS.....	221, 222	FRYKHOLM, Hohlmeißelzange.....	171	Haken, CUSHING.....	103
Dura-Dissektor, FRAZIER.....	223	FUCHSIG, Arterienklemme.....	88	Haken, ADSON.....	110
Dura-Dissektor, HOEN.....	223	Führungsinstrument, De MARTEL.....	177	Haken, CASPAR.....	136
Dura-Dissektor, HORSLEY.....	222			Haken, CRILE.....	109
Dura-Dissektor, MILLIGAN.....	222			Haken, CUSHING.....	109
Dura-Dissektor, OLIVECRONA.....	221			Haken, DANDY.....	108
Dura-Dissektor, SACHS.....	221			Haken, D'ERRICO.....	113
Dura-Dissektor, TOENNIS.....	221			Haken, FISCH.....	249
Dura-Dissektor, WOODSON.....	223			Haken, GRAHAM.....	110
Dura-Haken, ADSON.....	110			Haken, HESS.....	111
Dura-Haken, FISCH.....	249			Haken, HOLSHER.....	111
Dura-Schere, SCHMIEDEN-TAYLOR.....	34			Haken, KOCHER.....	104, 105
				Haken, KOCHER-LANGENBECK.....	104
				Haken, LANGENBECK.....	104, 105
				Haken, LOVE.....	113, 114
				Haken, MEYERDING.....	106
				Haken, SACHS.....	110
				Haken, SCOVILLE.....	111, 114, 137
				Haken, SMITHWICK.....	110
				Haken, TAYLOR.....	107

HALLE, scharfer Löffel.....	186	Hohlmeißelzange, MICRO FRIEDMAN.....	162	Klemme, CRILE.....	85
HALSEY, Nadelhalter.....	94	Hohlmeißelzange, OLIVECRONA.....	164	Klemme, CRILE-RANKIN.....	85
HALSTED-MOSQUITO, Arterienklemme.....	84	Hohlmeißelzange, RUSKIN.....	168	Klemme, DANDY.....	86
Halter, CASPAR.....	279, 280	Hohlmeißelzange, SAUERBRUCH.....	170	Klemme, FUCHSIG.....	88
Hammer, LEYLA.....	194	Hohlmeißelzange, SEMB.....	171	Klemme, GEMINI.....	89
Hammer.....	9, 10	Hohlmeißelzange, SMITH-PETERSON.....	166	Klemme, HALSTED-MOSQUITO.....	84
Hammer, BABINSKY.....	8	Hohlmeißelzange, STELLBRINK.....	162	Klemme, HARTMANN.....	83
Hammer, BERLINER.....	8	Hohlmeißelzange, STILLE-LUER.....	169	Klemme, JACOBSON.....	84
Hammer, BUCK.....	8	Hohlmeißelzange, STILLE-RUSKIN.....	169	Klemme, KELLY.....	85
Hammer, COTTLE.....	10	Hohlmeißelzange, ZAUFAL-JANSEN.....	167	Klemme, KELLY-RANKIN.....	85
Hammer, DEJERINE.....	8	HOLSHER, Nervwurzelhaken.....	111	Klemme, MIXTER-BABY.....	90
Hammer, OMBREDANNE.....	10	HOLZHEIMER, Wundspener.....	120	Klingenbrecher, CASTROVIEJO.....	17
Hammer, TAYLOR.....	8	Hornhautschere, CASTROVIEJO.....	36	Klingenbrecher, HADEO.....	17
Hammer, TROEMMER.....	8	HORSLEY, Dura-Dissektor.....	222	Klingenbrecher, TROUTMAN-CHRIS.....	17
Hammer, WAGNER.....	10	HOSOBUCHI, Spatel.....	267	KNIGHTON, Wundspreizer.....	134
Hammer, WILLIGER.....	9	HOUSE, Saugadapter.....	231	Knochenspanhalter, CASPAR.....	194
Handbohrapparat, BUNELL.....	325	HOUSE, Saugrohr.....	233	Knochensplitterzange, BÖHLER.....	172
Handbohrapparat, HUDSON.....	324	HUDSON, Handbohrapparat.....	324	Knochensplitterzange, COTTLE-KAZANJIAN.....	172
Handbohrapparat, KIRSCHNER.....	325	HUNT, Tumorzange.....	70, 71	Knochensplitterzange, LISTON.....	172
Handbohrapparat, MOORE.....	323	Hypophyse-Kürette, HARDY.....	268	Knochensplitterzange, Mc INDOE.....	172
Handbohrapparat, RALK.....	326	Hypophyse-Kürette, RAY.....	262	Knochensplitterzange, RUSKIN-LISTON.....	172
Handbohrapparat, HADEO.....	326	Hypophyse-Löffel, HARDY.....	269	Knochensplitterzange, SEMB.....	173
Handbohrapparat, STILLE.....	322	Hypophyse-Mikro-Schere.....	272	Knochensplitterzange, STAMM.....	172
Handbohrapparat, STILLE-SHERMAN.....	323	Hypophyse-Löffelzange.....	272	Knochensplitterzange, STILLE-HORSLEY.....	173
Handgriff, GIGLI.....	177	Hypophyse-Mikro-Zange.....	272	Knochensplitterzange, STILLE-LISTON.....	173
Handgriff, GIGLI-STRULLY.....	177	Hypophyse-Pinzette, ADSON.....	261	Knopfsonde, JACOBSON.....	249
Handgriff, HADEO.....	177	Hypophyse-Zange, LANDOLT.....	245	Knopfsonde, RHOTON.....	256
Handgriff, STRULLY.....	177	Hypophyse-Zange, NICOLA.....	271	Knüppelpinzette, Mikro.....	62, 64
Handgriff, WULLSTEIN.....	234	Hypophyse-Zange, OLDBERG.....	245	Koagulationshaken, CASPAR.....	115
HARDY, Enukleator.....	266	Hypophyse-Zange, YASARGIL.....	245	KOCHER, Wundhaken.....	104, 105
HARDY, Hypophyse-Kürette.....	268			KOCHER-LANGENBECK, Wundhaken.....	104
HARDY, Hypophyse-Löffel.....	269	I.....		KOENIG, Raspatorium.....	210
HARDY, Implantationsgabel.....	266	Implantationsgabel, HARDY.....	266	KOOS, Mikro-Gefäßmesser.....	248, 249
HARDY, Mikrospiegel.....	269	INGE, Lamina-Spreizer.....	152	Kopfhautklammer, RANEY.....	176
HARDY-FAHLBUSCH, Dissektor.....	266	IRIS, feine Schee.....	27	Kopfhautspreizer, SCALP-CONTOUR.....	127
HARTMANN, Arterienklemme.....	83			Kralle, Gewebe.....	255
HARVEY-JACKSON, Wundspreizer.....	133	J.....		KRAYENBÜHL, Nervhaken.....	116
Hauthäkchen, FRAZIER.....	102	JACOBSON, Doppelsonde.....	249	Kugelgelenkkloben, LEYLA.....	279, 280
Hauthäkchen, FREER.....	102	JACOBSON, Fadengabel.....	253	Kunststoffbacken f. Hammer.....	10
Hauthäkchen, GILLIES.....	102	JACOBSON, Gefäßmesser.....	117, 118	Kupplungskopf, LEYLA.....	279, 280
Hauthäkchen, JOSEPH.....	102	JACOBSON, Knopfsonde.....	249	Kürette, COBB.....	185
HEIFETZ, Hirnspatel.....	275	JACOBSON, Mikro-Arterienklemme.....	84	Kürette, CONE.....	260
HEIFETZ, Tumorzange.....	72	JACOBSON, Mikro-Federschere.....	44, 45	Kürette, FAHLBUSCH.....	270
Hemilaminotomie-Spreizer, DARLING.....	147	JAMESON-WERBER, Präparierschere.....	26	Kürette, HARDY.....	268
HENLEY, Retraktor.....	123	JANSEN, Hohlmeißelzange.....	164	Kürette, LANDOLT.....	267
HENLEY, Wundspreizer.....	123	JANSEN, Ohrpinzette.....	74	Kürette, LANDOLT-REULEN.....	270
HESS, Nervhaken.....	111	JANSEN, Raspatorium.....	206	Kürette, NICOLA.....	265
Hirnspatel, AACHEN.....	274	JANSEN, scharfer Doppellöffel.....	192	Kürette, RAY.....	262
Hirnspatel, CUSHING.....	274, 279	JANSEN, Wundspreizer.....	120		
Hirnspatel, DAVIS.....	275	JANSEN-GRUENWALD, Ohrpinzette.....	74	L.....	
Hirnspatel, HEIFETZ.....	275	JOHNS-HOPKINS, Bulldogklemme.....	83	Lagerungscontainer.....	313, 314
Hirnspatel, OLIVECRONA.....	274	JOSEPH, Hauthäkchen.....	102	LAMBOTTE, Osteotom.....	198
Hirnspatelhalter, LEYLA.....	276, 277	JOSEPH, Raspatorium.....	211	LAMBOTTE, Raspatorium.....	207
Hirnspatelhalter, YASARGIL.....	276	JOSEPH, Septumelektor.....	219	Laminotomie-Spreizer, BADGLEY.....	139
Hirnspatelpinzette, SCOVILLE.....	59	Juwelierpinzette.....	60, 61	Laminotomie-Spreizer, CASPAR.....	136
HOEN, Dura-Dissektor.....	223			Laminotomie-Spreizer, SCOVILLE.....	137
HOEN, Laminotomie-Zange.....	240	K.....		Laminotomie-Spreizer, SCOVILLE-HAVERFIELD.....	137
HOEN, Raspatorium.....	209	Kabel, AESCULAP, Bipolar.....	335	Laminotomie-Spreizer, SCOVILLE-RICHTER.....	138
Hohlmeißel, COBB.....	200	Kabel, BERCHTOLD, Bipolar.....	335	Laminotomie-Wundspreizer.....	131
Hohlmeißel, Ferrozellgriff.....	202	Kabel, Bipolar.....	335	Laminotomie-Zange, CASPAR.....	242, 243
Hohlmeißel, LEXER.....	201	Kabel, ERBE, Bipolar.....	335	Laminotomie-Zange, CLOWARD.....	239
Hohlmeißel, LEXER MINI.....	201	Kabel, MARTIN, Bipolar.....	335	Laminotomie-Zange, CUSHING.....	238
Hohlmeißel, NOVOTEX-Griff.....	203	Kabel, SELECT, Bipolar.....	335	Laminotomie-Zange, FERRIS-SMITH.....	241
Hohlmeißel, SMITH-PETERSON.....	197	Kabel, STORZ, Bipolar.....	335	Laminotomie-Zange, HOEN.....	240
Hohlmeißel, STILLE.....	196	Kabel, USA Mod., Bipolar.....	335	Laminotomie-Zange, LOVE-GRUENWALD.....	238
Hohlmeißel, ZIELKE.....	202	Kanüle, FRAZIER/FERGUSON.....	231	Laminotomie-Zange, SCHLESINGER.....	239
Hohlmeißelzange, ADSON.....	163	Kanüle, Mikro.....	232	Laminotomie-Zange, SPURLING.....	238
Hohlmeißelzange, BACON.....	166	KELLY, Arterienklemme.....	85	Laminotomie-Zange, WAGNER.....	241
Hohlmeißelzange, BANE-HARTMANN.....	164	KELLY, Gefäßschere.....	21	Laminotomie-Zange, WEIL-BLAKESLEY.....	244
Hohlmeißelzange, BEYER.....	165, 167	KELLY-RANKIN, Arterienklemme.....	85	LANDOLT, Enukleator.....	267
Hohlmeißelzange, BÖHLER.....	167	KERRISON, Stanze.....	287	LANDOLT, Haken.....	267
Hohlmeißelzange, ECHLIN.....	171	KEY, Elevatorium.....	218	LANDOLT, Hypophyse-Zange.....	245
Hohlmeißelzange, FRYKHOLM.....	171	KILNER, Präparierschere.....	26	LANDOLT, Kürette.....	267
Hohlmeißelzange, JANSEN.....	164	KIRSCHNER, Handbohrapparat.....	325	LANDOLT, Löffel.....	267
Hohlmeißelzange, KLEINERKUTZ.....	165	Klammer, RANEY.....	176	LANDOLT, Pinzette.....	264
Hohlmeißelzange, LEKSELL (STILLE).....	170	Klammeranlagezange, RANEY.....	176	LANDOLT, Skalpellgriff.....	16
Hohlmeißelzange, LEMPERT.....	164, 165	Klammerblock.....	174	LANDOLT, Spreizzange.....	263
Hohlmeißelzange, LUER.....	163	Klammerhalter.....	174	LANDOLT, Tumor-Faßzange.....	245
Hohlmeißelzange, MARQUARD.....	168	KLEINERT-KUTZ, Hohlmeißelzange.....	165	LANDOLT-REULEN, Dissektor.....	270
Hohlmeißelzange, MAYFIELD.....	167	Klemme, ADSON-BABY.....	88	LANDOLT-REULEN, Haken.....	270

## Index Deutsch

**HADEO**  
 INSTRUMENTE GERMANY

LANDOLT-REULEN, Küette	270
LANDOLT-REULEN, Raspatorium	270
LANGENBECK, Raspatorium	209
LANGENBECK, Wundhaken	104, 105
Lanzettenmesser, SAMII	252
LAZAR, Mikro-Knüpppinzette	63
LEKSELL (STILLE), Hohlmeißelzange	170
LEMPERT, Hohlmeißelzange	164, 165
LEMPERT, scharfer Löffel	190
LEXER MINI, Hohlmeißel	201
LEXER MINI, Osteotom	201
LEXER, Hohlmeißel	201
LEXER, Osteotom	201
LEXER, Präparierschere	22
LEYLA, Fixiervorrichtung	276, 278, 279
LEYLA, flexibler Spannarm	276, 278, 279
LEYLA, Haltearm	279, 280
LEYLA, Himspeitelhalter	276, 277
LEYLA, Kugelgelenkkloben	279, 280
LEYLA, Kupplungskopf	279, 280
LEYLA, Ohrspekulahalter	278
LEYLA, Ohrtrichterhalter	278
LEYLA, Retraktor-System	279
LEYLA, Spatelhalter	276, 279
LITSON, Knochensplitterzange	172
LITTLE-JOKER, Raspatorium	207
Löffel COBB	185
Löffel, BRUNS	188
Löffel, BUSHE	191
Löffel, DAUBENSPECK	189
Löffel, FAHLBUSCH	270
Löffel, Ferrozellgriff	189
Löffel, HALLE	186
Löffel, HARDY	269
Löffel, JANSEN	192
Löffel, LANDOLT	267
Löffel, LEMPERT	190
Löffel, Mikro	193
Löffel, HADEO	190, 191
Löffel, RHOTON	256
Löffel, SCOVILLE	187
Löffel, SPINAL	186, 187
Löffel, SPRATT	184
Löffel, VOLKMANN	184, 192
Löffel, YASARGIL	193
Löffelzange, Hypophyse	272
LOVE, Nervurzelhaken	113, 114
LOVE-GRUENWALD, Laminektomie-Zange	238
LUCAE, Ohrpinzette	74
LUER, Hohlmeißelzange	163
<b>M</b>	
MARKHAM-MEYERDING, Hemilaminektomie-Spreizer	148
MARQUARD, Hohlmeißelzange	168
MARTEL, Faßzange	87
MARTIN, Bipolar-Verbindungskabel	335
Maßband, Stahl	11
Maßstab, Metall	11
MATSON, Raspatorium	214
MATSON-ALEXANDER, Raspatorium	214
MAYFIELD, Hohlmeißelzange	167
MAYO, Pinzette	58
MAYO, Präparierschere	22
MAYO-ADAMS, Wundspreizer	124
MAYO-HEGAR, Nadelhalter	95
MAYO-STILLE, Präparierschere	22
Mc DONALD, Elevatorium	219
Mc INDOE, anatomische Pinzette	55
Mc INDOE, Knochensplitterzange	172
Mc KENZIE, Anlegezange	174
Mc KENZIE, Bohrer	324
Mc INDOE, chirurgische Pinzette	55
MEHDORN, Anlegepinzette	307
MEHDORN, Gefäßclip	307
Meißel, COBB	200
Meißel, Ferrozellgriff	202
Meißel, LEXER	201
Meißel, LEXER MINI	201
Meißel, NOVOTEX-Griff	203
Meißel, SMITH-PETERSON	197
Meißel, STILLE	196
Meißel, Wirbelsäule	203
Meißel, ZIELKE	202
Messer, JACOBSON	117, 118
Messer, SAMII	251, 252
Meßschieber	11
Metall, Maßstab	11
Metalbacken f. Hammer	10
METZENBAUM, Präparierschere	23
METZENBAUM-BLACK, Präparierschere	24, 25
METZENBAUM-FINO, Präparierschere	23
MEYERDING, Hemilaminektomie-Spreizer	148
MEYERDING, Wundhaken	106
MICHELE, Biopsie-Bohrer	182
Mikro-Federschere, YASARGIL	41, 42, 45
Mikro-Clip, ACLAND	315 - 317
Mikro-Dissektor	227, 228
Mikro-Dissektor, CASPAR	227, 228
Mikro-Federschere	35, 38 - 45
Mikro-Federschere, JACOBSON	44, 45
Mikro-Federschere, MILLESI	44, 45
Mikro-Federschere, NAGEL	43
Mikro-Federschere, POTTS-YASARGIL	44, 45
Mikro-Federschere, Rundgriff	46
Mikro-Federschere, VANNAS	37, 42, 44, 45
Mikro-Gefäßmesser	118
Mikro-Gefäßmesser, KOOS	248, 249
Mikro-Gefäßmesser, YASARGIL	248
Mikro-Häkchen	118
Mikro-Kanülen	232
Mikro-Knüpppinzette	62, 64
Mikro-Knüpppinzette, AUSTIN	64
Mikro-Knüpppinzette, LAZAR	63
Mikro-Knüpppinzette, VISE	64
Mikro-Löffel	193
Mikro-Löffel, YASARGIL	193
Mikro-Nadelhalter	99, 100
Mikro-Pinzette, anatomisch	56
Mikro-Pinzette, YASARGIL	75
Mikro-Präparierschere, Rundgriff	46
Mikro-Raspatorium, YASARGIL	225 - 227
Mikro-Ringpinzette	66
Mikro-Ringpinzette, dia maritit	66
Mikro-Ringpinzette, Titan	66
Mikro-Saugkanülen f. WULLSTEIN	234
Mikro-Schere, FAHLBUSCH	271
Mikro-Schere, Hypophyse	272
Mikro-Schere, NICOLA	271
Mikro-Schere, Titan	38 - 40
Mikro-Spiegel, HARDY	269
Mikro-Zange, Hypophyse	272
MILLES, Mikro-Federschere	44, 45
MILLIGAN, Dura-Dissektor	222
MILLS, Gefäßschere	29
Mini-Bulldogklemme, atrauma, De BAKEY-DIETRICH	78
Mini-Bulldogklemme, DIETRICH	78
MINI-LAMBOTTE, Osteotom	199
MISKIMOM, Wundspreizer	128
MIXTER-BABY, Arterienklemme	90
MOLLISON, Wundspreizer	122
MOLT, Raspatorium	210
MOORE, Handbohrapparat	323
MÜLLER, Approximator	309
MÜLLER, Gefäßclip	310, 311
<b>N</b>	
Nadel, RHOTON	256
Nadelhalter TC, De BAKEY	95
Nadelhalter TC, RYDER	95
Nadelhalter, BARRAQUER	96
Nadelhalter, BAUMGARTNER	94
Nadelhalter, CASTROVIEJO	97
Nadelhalter, CRILE-WOOD	94
Nadelhalter, HALSEY	94
Nadelhalter, MAYO-HEGAR	95
Nadelhalter, Mikro	99, 100
Nadelhalter, NEIVERT	94
Nadelhalter, YASARGIL, Mikro	98
Nadeln f. Approximator	312
NAGEL, Mikro-Federschere	43
NEIVERT, Nadelhalter	94
Nerv-Approximator, BIEMER	312
Nervhäkchen, KRAYENBÜHL	116
Nervhaken, CRILE	109
Nervhaken, CUSHING	109
Nervhaken, DANDY	108
Nervhaken, GRAHAM	110
Nervhaken, SACHS	110
Nervhaken, SMITHWICK	110
Nervrädchen, WARTENBERG	11
Nervwundhaken, D'ERRICO	113
Nervwurzelhaken, CASPAR	112
Nervwurzelhaken, HESS	111
Nervwurzelhaken, HOLSHER	111
Nervwurzelhaken, LOVE	113, 114
Nervwurzelhaken, SCOVILLE	111, 114
Neuro, chirurgische Schere	27
Neuro, Stimmgabel	11
Neurochirurgie-Schere, STRULLY	33
NICOLA, Hypophyse-Zange	271
NICOLA, Kürette	265
NICOLA, Mikro-Schere	271
NICOLA, Raspatorium	265
NORFOLK/NORWICH, Wundspreizer	124
NOVOTEX-Griff, Hohlmeißel	203
<b>O</b>	
Ohrpinzette, JANSEN	74
Ohrpinzette, JANSEN-GRUENWALD	74
Ohrpinzette, LUCAE	74
Ohrspekulahalter, LEYLA	278
Ohrspekulahalter, YASARGIL	278
Ohrtrichterhalter, LEYLA	278
OKONEK-YASARGIL, Tumogabel	254
OLDBERG, Hypophyse-Zange	245
OLIVECRONA, Drahtsäge	177
OLIVECRONA, Dura-Dissektor	221
OLIVECRONA, Hirnspatel	274
OLIVECRONA, Hohlmeißelzange	164
OLIVECRONA, Trigemini-Schere	33
OLIVECRONA-TOENNIS, Anlegezange	174
OMBREDANNE, Stahlhammer	110
Ophthalmologie-Schere	28
Ophthalmologie-Schere, GRADLE	28
Ophthalmologie-Schere, STEVENS	28
Osteotom, COTTLE	204
Osteotom, LAMBOTTE	198
Osteotom, LEXER	201
Osteotom, LEXER MINI	201
Osteotom, MINI-LAMBOTTE	199
Osteotom, SMITH-PETERSON	197
Osteotom, STILLE	196
<b>P</b>	
PAPAVERO-CASPAR, Speküla	264
PAPAVERO-HARTMANN, Spreizer	264
PENFIELD, Dissektor	224
Perkussionshammer, BABINSKY	8
Perkussionshammer, BERLINER	8
Perkussionshammer, BUCK	8
Perkussionshammer, DEJERINE	8
Perkussionshammer, TAYLOR	8
Perkussionshammer, TROEMMER	8
Pinzette f. Blätter	144, 156
Pinzette, ACLAND	318



Pinzette, ADLERKREUZ.....	54
Pinzette, ADSON.....	51, 261
Pinzette, ADSON-BROWN.....	52
Pinzette, ADSON-De BAKEY.....	51
Pinzette, atrauma.....	65
Pinzette, AUSTIN.....	64
Pinzette, BIEMER.....	306, 311
Pinzette, Bipolar.....	328 - 331, 334
Pinzette, Bipolar, Antihaf.....	332, 333
Pinzette, BROPHY.....	54
Pinzette, BROWN.....	53
Pinzette, COTTLE.....	74
Pinzette, CUSHING.....	53
Pinzette, CUSHING (TAYLOR).....	57
Pinzette, diamantiert.....	66
Pinzette, DUEHRSEN.....	55
Pinzette, GERALD.....	56, 57
Pinzette, GILLIES.....	56
Pinzette, HEIFETZ.....	72
Pinzette, HUNT.....	70, 71
Pinzette, JANSEN.....	74
Pinzette, JANSEN-GRUENWALD.....	74
Pinzette, LANDOLT.....	264
Pinzette, LAZAR.....	63
Pinzette, LUCAE.....	74
Pinzette, MAYO.....	58
Pinzette, Mc INDOE.....	55
Pinzette, MEHDORN.....	307
Pinzette, Mikro.....	66
Pinzette, POTTS-SMITH.....	50
Pinzette, SAMII.....	73
Pinzette, SCOVILLE.....	59
Pinzette, SEMKEN.....	56
Pinzette, TAYLOR.....	58
Pinzette, Titan.....	66
Pinzette, Tumor.....	70
Pinzette, Uhrmacher.....	60, 61
Pinzette, VISE.....	64
Pinzette, WANGENSTEEN.....	58
Pinzette, WAUGH.....	53
Pinzette, YASARGIL.....	70, 72, 75
Pinzette, YASARGIL-SAMII.....	72
PLESTER, Saugrohr.....	233
PLESTER, Wundspreizer.....	122, 124
POTTS-De MARTEL, Gefäßscheer.....	29
POTTS-SMITH, anatomische Pinzette.....	50
POTTS-SMITH, chirurgische Pinzette.....	50
POTTS-SMITH, Gefäßschere.....	30, 31
POTTS-YASARGIL, Mikro-Federschere.....	44, 45
Präparierschere, BLACK.....	25
Präparierschere, DEEVER.....	21
Präparierschere, JAMESON-WERBER.....	26
Präparierschere, KILNER.....	26
Präparierschere, LEXER.....	22
Präparierschere, MAYO.....	22
Präparierschere, MAYO-STILLE.....	22
Präparierschere, METZENBAUM.....	23
Präparierschere, METZENBAUM-BLACK.....	24, 25
Präparierschere, METZENBAUM-FINO.....	23
Präparierschere, REYNOLDS.....	26
Präparierschere, TOENNIS-ADSON.....	27
Präparierschere, YASARGIL.....	42
Punktionskanüle, FRAZIER/FERGUSSON.....	231
Q	
QUERVAIN, Elevatorium.....	208
R	
Rädchen, WARTENBERG.....	11
Rahmen, SCOVILLE-HAVERFIELD.....	137
Rahmen, SCOVILLE-RICHTER.....	138
RALK, Handbohrapparat.....	326
RANEY, Klammeranlagezange.....	176
RANEY, Kopfhautklammer.....	176
Raspatorium, CUSHING.....	208
Raspatorium, ADSON.....	218
Raspatorium, ALEXANDER.....	210
Raspatorium, COBB.....	217
Raspatorium, CUSHING (LITTLE-JOKER).....	207
Raspatorium, DOYEN.....	212, 213
Raspatorium, FARABEUF.....	206
Raspatorium, FARABEUF-COLLIN.....	206, 207
Raspatorium, Ferrozellgriff.....	215, 216
Raspatorium, FOMON.....	211
Raspatorium, HOEN.....	209
Raspatorium, JANSEN.....	206
Raspatorium, JOSEPH.....	211
Raspatorium, KOENIG.....	210
Raspatorium, LAMBOTTE.....	207
Raspatorium, LANDOLT-FREULEN.....	270
Raspatorium, LANGENBECK.....	209
Raspatorium, LITTLE-JOKER.....	207
Raspatorium, MATSON.....	214
Raspatorium, MATSON-ALEXANDER.....	214
Raspatorium, MOLT.....	210
Raspatorium, NICOLA.....	265
Raspatorium, RHOTON.....	256
Raspatorium, SEDILLOT.....	207, 208
Raspatorium, SELDIN.....	211
Raspatorium, WAGNER.....	217
Raspatorium, WILLINGER.....	210
Raspatorium, YASARGIL.....	225 - 227
RAY, Hypophyse-Kürette.....	262
HADEO, Draisinsäge-Handgriff.....	177
HADEO Handbohrapparat.....	326
HADEO, Klingensbecher.....	17
HADEO, scharfer Löffel.....	190, 191
Retraktor, CLOWARD.....	103
Retraktor, HENLEY.....	123
Retraktor-System, LEYLA.....	279
REYNOLDS, Präparierschere.....	26
RHOTON, Dissektor.....	256
RHOTON, Hähchen.....	256
RHOTON, Knopfsonde.....	256
RHOTON, Nadel.....	256
RHOTON, Raspatorium.....	256
RHOTON, scharfer Löffel.....	256
Ringkürette, CONE.....	260
Ringpinzette, Mikro.....	66
Rippenschere, GIERTZ-STILLE.....	48
Rippenschere, SAUERBRUCH.....	48
Rippenschere, SAUERBRUCH-FREY.....	48
ROGER, Septumlevator.....	220
Rundgriff, Mikro-Federschere.....	46
Rundgriff, Mikro-Präparierschere.....	46
RUSKIN, Hohlmeißelzange.....	168
RUSKIN-LISTON, Knochensplitterzange.....	172
RYDER, Nadelhalter TC.....	95
S	
SACHS, Dura-Dissektor.....	221
SACHS, Nervhaken.....	110
SAMII, Lanzettenmesser.....	252
SAMII, Tumormesser.....	251, 252
SAMII, Tumorphinzette.....	73
SAUERBRUCH, Hohlmeißelzange.....	170
SAUERBRUCH, Rippenschere.....	48
SAUERBRUCH-FREY, Rippenschere.....	48
Saugadapter, HOUSE.....	231
Saughandgriff, WULLSTEIN.....	234
Saugkanüle, GUILLEN.....	235
Saugkanüle f. WULLSTEIN.....	234
Saugpinzette, Bipolar.....	334
Saugraspatorium, GUILLEN.....	235
Saugrohr.....	232
Saugrohr, ADSON.....	230
Saugrohr, BARON.....	231
Saugrohr, FRAZIER.....	230
Saugrohr, FRAZIER/FERGUSSON.....	231
Saugrohr, HOUSE.....	233
Saugrohr, PLESTER.....	233
Saugrohr, SCHUHKNECHT.....	231
Saugrohr, WULLSTEIN.....	234
Saugrohr, YASARGIL.....	232
Saugrohr, ZÖLLNER.....	232
SCALP-CONTOUR, Kopfhautspreizer.....	127
Schädelhalter, CRUTCHFIELD.....	176
Schädelstanze, CONE.....	179
Schädeltrephine, GALT.....	181
Schädelzange, De VILBISS.....	178
Scharfer Löffel, BRUNS.....	188
Scharfer Löffel, BUSHE.....	191
Scharfer Löffel, DAUBENSPECK.....	189
Scharfer Löffel, Ferrozellgriff.....	189
Scharfer Löffel, HALLE.....	186
Scharfer Löffel, LEMPEIT.....	190
Scharfer Löffel, HADEO.....	190, 191
Scharfer Löffel, SCOVILLE.....	187
Scharfer Löffel, SPINAL.....	186, 187
Scharfer Löffel, SPRATT.....	184
Scharfer Löffel, VOLKMANN.....	184
Schere, BIEMER.....	44, 45
Schere, BLACK.....	25
Schere, CASTROVIEJO.....	36
Schere, chirurgisch, STANDARD.....	20
Schere, DANDY.....	33
Schere, De BAKEY.....	30 - 32
Schere, DEEVER.....	21
Schere, DIETRICH.....	29, 30
Schere, FAHLBUSCH.....	271
Schere, FAVALORO.....	32
Schere, GIERTZ-STILLE.....	48
Schere, GRADLE.....	28
Schere, IRIS.....	27
Schere, JACOBSON.....	44, 45
Schere, JAMESON-WERBER.....	26
Schere, KELLY.....	21
Schere, KILNER.....	26
Schere, LEXER.....	22
Schere, MAYO.....	22
Schere, MAYO-STILLE.....	22
Schere, METZENBAUM.....	23
Schere, METZENBAUM-BLACK.....	24, 25
Schere, METZENBAUM-FINO.....	23
Schere, Mikro.....	35, 38 - 45
Schere, Mikro, Hypophyse.....	272
Schere, MILLES.....	44, 45
Schere, MILLS.....	29
Schere, NAGEL.....	43
Schere, Neuro.....	27
Schere, NICOLA.....	271
Schere, OLIVECRONA.....	33
Schere, Ophthalmologie.....	28
Schere, POTTS-De MARTEL.....	29
Schere, POTTS-SMITH.....	30, 31
Schere, POTTS-YASARGIL.....	44, 45
Schere, REYNOLDS.....	26
Schere, Rundgriff, Mikro.....	46
Schere, SAUERBRUCH.....	48
Schere, SAUERBRUCH-FREY.....	48
Schere, SCHMIEDEN-TAYLOR.....	34
Schere, STEVENS.....	28
Schere, STRULLY.....	33
Schere, Titan.....	38 - 40
Schere, TOENNIS-ADSON.....	27
Schere, Tumor.....	47
Schere, UNIVERSAL.....	34
Schere, VANNAS.....	37, 42, 44, 45
Schere, YASARGIL.....	41, 42, 45
Schere, Titan, Mikro.....	38 - 40
SCHLESINGER, Laminektomie-Zange.....	239
Schlüssel f. Approximator.....	312
Schlüssel f. BUNELL.....	325
Schlüssel f. CASPAR.....	136
Schlüssel f. Hammer.....	10
SCHMIEDEN-TAYLOR, Dura-Scheer.....	34
Schraube, Distraction.....	160



## Index Deutsch

HADEO  
INSTRUMENTE GERMANY

Schraubendreher .....	160	Spreizer, MARKHAM-MEYERDING .....	148	Tumormesser, SAMII .....	251, 252
SCHUHKNECHECHT, Saugohr .....	231	Spreizer, MAYO-ADAMS .....	124	Tumorzinnette .....	70
Schutzzange, Bohrlloch .....	180	Spreizer, MEYERDING .....	148	Tumorzinnette, HEIFETZ .....	72
Schwarze Valve .....	154, 156, 157	Spreizer, MISKIMOM .....	128	Tumorzinnette, HUNT .....	70, 71
SCOVILLE, Haken .....	137	Spreizer, MOLLISON .....	122	Tumorzinnette, SAMII .....	73
SCOVILLE, Hirnspatelzinnette .....	59	Spreizer, NORFOLK/NORWICH .....	124	Tumorzinnette, YASARGIL .....	70, 72, 75
SCOVILLE, Laminektomie-Spreizer .....	137	Spreizer, PAPAVERO-HARTMANN .....	264	Tumorzinnette, YASARGIL-SAMII .....	72
SCOVILLE, Nervwurzelhaken .....	111, 114	Spreizer, PLESTER .....	122, 124	Tumorschere .....	47
SCOVILLE, scharfer Löffel .....	187	Spreizer, SCALP-CONTOUR .....	127		
SCOVILLE, Valve .....	137	Spreizer, SCOVILLE .....	137	U	
SCOVILLE-HAVERFIELD, Laminektomie-Spreizer .....	137	Spreizer, SCOVILLE-HAVERFIELD .....	137	Uhrmacherzinnette .....	60, 61
SCOVILLE-HAVERFIELD, Rahmen .....	137	Spreizer, SCOVILLE-RICHTER .....	138	Ultra-Light-Pinnette, atrauma .....	65
SCOVILLE-RICHTER, Laminektomie-Spreizer .....	138	Spreizer, TRAVERS .....	125	UNIVERSAL, Dahtschere .....	34
SCOVILLE-RICHTER, Rahmen .....	138	Spreizer, WALTON .....	135	USA Mod., Bipolar-Verbindungskabel .....	335
SCOVILLE-RICHTER, Valen .....	138	Spreizer, WEITLANER .....	121		
SEBILEAU, Elevatorium .....	208	Spreizer, WEITLANER-WULLSTEIN .....	121	V	
SEDILLOT, Raspatorium .....	207, 208	Spreizer, WILLIAMS .....	149	Valve, medial, lateral .....	146
Sehnentafzange, CAROLL .....	92	Spreizer, WULLSTEIN .....	122	Valve, SCOVILLE .....	137
SELDIN, Raspatorium .....	211	Spreizzange, LANDOLT .....	263	Valve, TAYLOR .....	137
SELECT, Bipolar-Verbindungskabel .....	335	SPURLING, Laminektomie-Zange .....	238	Valve .....	123
SEMB, Hohlmeißelzange .....	171	Stahl, Maßband .....	11	Valve, schwarz .....	154, 156, 157
SEMB, Knochensplitterzange .....	173	Stahlhammer, COTTLE .....	10	Valve, SCOVILLE-RICHTER .....	138
SEMKEN, anatomische Pinnette .....	56	Stahlhammer, OMBREDANNE .....	10	Valve, Titan .....	145, 146
SEMKEN, chirurgische Pinnette .....	56	Stahlhammer, WAGNER .....	10	VANNAS, Mikro-Federschere .....	37, 42, 44, 45
Septumeleuator, FREER .....	220	STAMM, Knochensplitterzange .....	172	Venenschere, BIEMER .....	44, 45
Septumeleuator, JOSEPH .....	219	STANDARD, chirurgische Scheren .....	20	Verbindungskabel, AESCULAP .....	335
Septumeleuator, ROGER .....	220	Stanze, CITELLI .....	288	Verbindungskabel, BERCHTOLD .....	335
SEWALL, Elevatorium .....	219	Stanze, COLCLOUGH .....	286	Verbindungskabel, Bipolar .....	335
Skalpellgriff .....	14 - 16	Stanze, CONE .....	179	Verbindungskabel, ERBE .....	335
Skalpellgriff, CASPAR .....	16	Stanze, FERRIS-SMITH-KERRISON .....	282 - 285	Verbindungskabel, MARTIN .....	335
Skalpellgriff, LANDOLT .....	16	Stanze, HAJEK-KOFLER .....	287, 288	Verbindungskabel, SELECT .....	335
Skalpellklingen .....	15	Stanze, KERRISON .....	287	Verbindungskabel, STORZ .....	335
SMITH-PETERSEN, Hohlmeißel .....	197	STELLBRINK, Hohlmeißelzange .....	162	Verbindungskabel, USA Mod. .....	335
SMITH-PETERSEN, Hohlmeißelzange .....	166	Sterilisiercontainer .....	313, 314	Verlängerungsstück f. HUSON .....	324
SMITH-PETERSEN, Osteotom .....	197	STEVENS, Ophthalmologie-Schere .....	28	WISE, Mikro-Knüpfpinnette .....	64
SMITH-PETERSEN, Anlegezange .....	174	STILLE, Flachmeißel .....	196	VOLKMANN, scharfer Doppellöffel .....	192
SMITH-PETERSEN, Nervhaken .....	110	STILLE, Handbohrapparat .....	322	VOLKMANN, scharfer Löffel .....	184
Sonde, JACOBSON .....	249	STILLE, Hohlmeißel .....	196		
Sonde, RHOTON .....	256	STILLE, Osteotom .....	196	W	
Spannschlüssel f. Bohrrapparat .....	326	STILLE-HORSLEY, Knochensplitterzange .....	173	WAGNER, Laminektomie-Zange .....	241
Spatel, AACHEN .....	274	STILLE-LISTON, Knochensplitterzange .....	173	WAGNER, Raspatorium .....	217
Spatel, CUSHING .....	274, 279	STILLE-LUER, Hohlmeißelzange .....	169	WAGNER, Stahlhammer .....	10
Spatel, DAVIS .....	275	STILLE-RUSKIN, Hohlmeißelzange .....	169	WALTON, Wundspreizer .....	135
Spatel, HEIFETZ .....	275	STILLE-SHERMAN, Handbohrapparat .....	323	WANGENSTEIN, Gefäßpinnette .....	58
Spatel, HOSOBUCHI .....	267	Stimmgabel, Neuro .....	11	WARTENBERG, Nervrädchen .....	11
Spatel, OLIVECRONA .....	274	STORZ, Bipolar-Verbindungskabel .....	335	WATSON-CHEYNE, Elevatorium .....	219
Spatelhalter, LEYLA .....	276, 277, 279	Stößel, CASPAR .....	195	WAUGH, chirurgische Pinnette .....	53
Spatelhalter, YASARGIL .....	276	Stößel, Ferrozellgriff .....	195	Wechselpinnette f. Blätter .....	144, 156
Spekula, CASPAR .....	155	STRULLY, Drahtsäge-Handgriff .....	177	WEIL-BLAKESLEY, Laminektomie-Zange .....	244
Spekula, CUSHING-LANDOLT .....	263	STRULLY, Schere, Neurochirurgie .....	33	WEITLANER, Wundspreizer .....	121
Spekula, PAPAVERO-CASPAR .....	264	SWEET, Anlegezange .....	174	WEITLANER-WULLSTEIN, Wundspreizer .....	121
Spekulahalter, LEYLA .....	278			WILLET-MARTEL, Faßzange .....	87
Spekulahalter, YASARGIL .....	278	T		WILLIAMS, Hemilaminektomie-Spreizer .....	149
Sperrer, CASPAR .....	156	TAYLOR, anatomische Pinnette .....	58	WILLIGER, Hammer .....	9
Sperrer, CLOWARD .....	140 - 143	TAYLOR, chirurgische Pinnette .....	58	WILLIGER, Raspatorium .....	210
Spiegel, HARDY .....	269	TAYLOR, Perkussionshammer .....	8	Wirbelkörperspreizer, CLOWARD .....	151, 153
SPINAL, scharfer Löffel .....	186, 187	TAYLOR, Spinalhaken .....	107	Wirbelkörperspreizer, INGE .....	152
Spinalhaken, TAYLOR .....	107	TAYLOR, Valve .....	137	Wirbelsäulenmeißel .....	203
SPRATT, scharfer Löffel .....	184	Teleskop-Bohrdrahtstütze f. KIRSCHNER .....	325	WOODSON, Dura-Dissektor .....	223
Spreizer, ADSON .....	125, 126, 129	Teleskop-Stütze f. KIRSCHNER .....	325	WULLSTEIN, Saughandgriff .....	234
Spreizer, ALM .....	120	Titan, Ringpinnette .....	66	WULLSTEIN, Saugrohr .....	234
Spreizer, ANDERSON-ADSON .....	128	Titan, Schere .....	38 - 40	WULLSTEIN, Wundspreizer .....	122
Spreizer, BADGLEY .....	139	Titan-Atrauma-Bulldogklemme .....	79	Wundhaken, CUSHING .....	103
Spreizer, BECKMANN .....	132	Titan-Blätter .....	145, 146	Wundhaken, KOCHER .....	104, 105
Spreizer, BECKMANN-ADSON .....	130	Titan-Mikro-Schere .....	38 - 40	Wundhaken, KOCHER-LANGENBECK .....	104
Spreizer, BECKMANN-ADSON (CONE) .....	126	TOENNIS, Dura-Dissektor .....	221	Wundhaken, LANGENBECK .....	104, 105
Spreizer, BECKMANN-EATON .....	132	TOENNIS, Tumorfäßzange .....	91	Wundhaken, MEYERDING .....	106
Spreizer, BIEMER .....	250	TOENNIS-ADSON, Präparierschere .....	27	Wundsperrer, CLOWARD .....	140 - 143
Spreizer, CASPAR .....	136	TRAVERS, Wundspreizer .....	125	Wundsperrer, HOLZHEIMER .....	120
Spreizer, CLOWARD .....	140 - 143, 151, 153	Trephine f. STILLE .....	322	Wundspreizer .....	131
Spreizer, CONE .....	126	Trephine, GALT .....	181	Wundspreizer, ADSON .....	125, 126, 129
Spreizer, DARLING .....	147	Trephine, MICHELE .....	182	Wundspreizer, ALM .....	120
Spreizer, GELPI .....	150	Trigeminus-Schere, DANDY .....	33	Wundspreizer, ANDERSON-ADSON .....	128, 130
Spreizer, HARVEY-JACKSON .....	133	Trigeminus-Schere, OLIVECRONA .....	33	Wundspreizer, BECKMANN .....	132
Spreizer, HENLEY .....	123	TROEMMER, Perkussionshammer .....	8	Wundspreizer, BECKMANN-ADSON (CONE) .....	126
Spreizer, HOLZHEIMER .....	120	TROUTMAN-CHRIS, Klingendreher .....	17	Wundspreizer, BECKMANN-EATON .....	132
Spreizer, INGE .....	152	Tumorfäßzange, LANDOLT .....	245	Wundspreizer, CASPAR .....	144, 154, 156
Spreizer, JANSEN .....	120	Tumorfäßzange, TOENNIS .....	91	Wundspreizer, CONE .....	126
Spreizer, KNIGHTON .....	134	Tumorgabel, OKONEK-YASARGIL .....	254	Wundspreizer, DARLING .....	147
Spreizer, Laminektomie .....	131	Tumorgabel, YASARGIL .....	257	Wundspreizer, GELPI .....	150

Wundspreizer, HARVEY-JACKSON .....	133	Zange, RUSKIN .....	168
Wundspreizer, HENLEY .....	123	Zange, RUSKIN-LISTON .....	172
Wundspreizer, JANSEN .....	120	Zange, SAUERBRUCH .....	170
Wundspreizer, KNIGHTON .....	134	Zange, SCHLESINGER .....	239
Wundspreizer, MARKHAM-MEYERDING .....	148	Zange, SEMB .....	171, 173
Wundspreizer, MAYO-ADAMS .....	124	Zange, SMITH-PETERSON .....	166
Wundspreizer, MEYERDING .....	148	Zange, SMITHWICK .....	174
Wundspreizer, MISKIMOM .....	128	Zange, SPURLING .....	238
Wundspreizer, MOLLISON .....	122	Zange, STAMM .....	172
Wundspreizer, NORFOLK/NORWICH .....	124	Zange, STELLBRINK .....	162
Wundspreizer, PLESTER .....	122, 124	Zange, STILLE-HORSLEY .....	173
Wundspreizer, TRAVERS .....	125	Zange, STILLE-LISTON .....	173
Wundspreizer, WALTON .....	135	Zange, STILLE-LUER .....	169
Wundspreizer, WEITLANER .....	121	Zange, STILLE-RUSKIN .....	169
Wundspreizer, WEITLANER-WULLSTEIN .....	121	Zange, SWEET .....	174
Wundspreizer, WILLIAMS .....	149	Zange, TOENNIS .....	91
Wundspreizer, WULLSTEIN .....	122	Zange, WAGNER .....	241
		Zange, WEIL-BLAKESLEY .....	244
Y		Zange, WILLET-MARTEL .....	87
YASARGIL, Aneurysmen-Gefäßclip .....	294 - 301	Zange, YASARGIL .....	245
YASARGIL, Fadenführer .....	116	Zange, YASARGIL-NICOLA .....	271
YASARGIL, flexibler Spannarm .....	278	Zange, ZAUFAL-JANSEN .....	167
YASARGIL, Galeahaken .....	114	ZAUFAL-JANSEN, Hohlmeißelzange .....	167
YASARGIL, Himspatelhalter .....	276	ZIELKE, Hohlmeißel .....	202
YASARGIL, Hypophyse-Zange .....	245	ZÖLLNER, Saugrohr .....	232
YASARGIL, Mikro-Federschere .....	41, 42, 45		
YASARGIL, Mikro-Gefäßmesser .....	248		
YASARGIL, Mikro-Öffel .....	193		
YASARGIL, Mikro-Nadelhalter .....	98		
YASARGIL, Mikro-Pinzette .....	75		
YASARGIL, Mikro-Raspator .....	225 - 227		
YASARGIL, Ohrspekulahalter .....	278		
YASARGIL, Präparierschere .....	42		
YASARGIL, Saugrohr .....	232		
YASARGIL, Tumorgabel .....	257		
YASARGIL, Tumorzange .....	70, 72, 75		
YASARGIL-NICOLA, Falzange .....	271		
YASARGIL-SAMILI, Tumorzange .....	72		
Z			
Zange f. Gefäßclips .....	302 - 305		
Zange f. offene Chirurgie .....	319, 320		
Zange, ADSON .....	163, 181		
Zange, BACON .....	166		
Zange, BANE-HARTMANN .....	164		
Zange, BEYER .....	165, 167		
Zange, BÖHLER .....	167, 172		
Zange, Bohrlöcher .....	180		
Zange, Bulldogklemme .....	83		
Zange, CAROLL .....	92		
Zange, CASPAR .....	242, 243		
Zange, CLOWARD .....	239		
Zange, COTTLE-KAZANJIAN .....	172		
Zange, CUSHING .....	238		
Zange, De VILBISS .....	178		
Zange, ECHLIN .....	171		
Zange, FERRIS-SMITH .....	241		
Zange, FRIEDMAN .....	162		
Zange, FRYKHOLM .....	171		
Zange, HOEN .....	240		
Zange, JANSEN .....	164		
Zange, KLEINERTKUTZ .....	165		
Zange, LANDOLT .....	245, 263		
Zange, LEKSELL (STILLE) .....	170		
Zange, LEMPERT .....	164, 165		
Zange, LISTON .....	172		
Zange, Löffel, Hypophyse .....	272		
Zange, LOVE-GRUENWALD .....	238		
Zange, LUER .....	163		
Zange, MARQUARD .....	168		
Zange, MARTEL .....	87		
Zange, MAYFIELD .....	167		
Zange, Mc INDOE .....	172		
Zange, Mc KENZIE .....	174		
Zange, Mikro, Hypophyse .....	272		
Zange, NICOLA .....	271		
Zange, OLDBERG .....	245		
Zange, OLIVECRONA .....	164		
Zange, OLIVECRONA-TOENNIS .....	174		
Zange, RANEY .....	176		

## Index English

**HADEO**  
 INSTRUMENTE GERMANY

<b>A</b>		<b>BROWN</b> forceps .....53	<b>curette SPINAL</b> .....186, 187
AACHEN brain spatula .....274		BRUNS curette .....188	curette SPRATT .....184
ACLAND applying forceps .....318		BUCK percussion hammer .....8	curette VOLKMANN .....184
ACLAND clips .....315-317		bulldog clamps .....78-83	curette double JANSEN .....192
ADLERKREUTZ forceps .....54		bulldog clamp DE BAKEY .....80, 81, 82	curette double VOKMANN .....192
ADSON drill guide and forceps .....181		bulldog clamp DE BAKEY-DIETRICH .....78	curettes .....262
ADSON forceps .....51, 52		bulldog clamp DE BAKEY-HESS .....82	curettes bone .....184-192
ADSON hypophyseal forceps .....261		bulldog clamp DIEFFENBACH .....83	CUSHING brain spatula .....274
ADSON nerve hook .....110		bulldog clamp DIETRICH .....78	CUSHING drill .....324
ADSON raspatory .....218		bulldog clamp GLOVER .....80, 81	CUSHING elevator .....207, 208
ADSON retractor .....125, 126, 129		bulldog clamp JOHNS-HOPKINS .....83	CUSHING forceps .....53
ADSON rongeur .....163		bulldog clamp applying for cepts .....83	CUSHING laminectomy forceps .....238
ADSON suction tube .....230		BUNELL drill .....325	CUSHING nerve hook .....109
ADSON micro forceps .....51		BUSHE curette .....191	CUSHING retractor .....103
ADSON-BABY forceps .....88			CUSHING-LANDOLT speculum .....263
ADSON-BROWN forceps .....52		<b>C</b>	CUSHING-TAYLOR forceps .....57
ADSON-DE BAKEY forceps .....51		caliper .....11	
ALEXANDER elevator .....210		CAROLL forceps .....92	<b>D</b>
ALM retractor .....120		CASPAR bone graft holder and impactor .....194	DANDY forceps .....86
ANDERSON-ADSON retractor .....128		CASPAR dissector .....227, 228	DANDY nerve hook .....108
applying forceps ACLAND .....318		CASPAR distractor .....158	DANDY scissors .....33
applying forceps BIEMER .....306, 308, 309, 311		CASPAR exploration hook .....112, 115	DARLING retractor .....147
applying forceps MEHDORN .....307		CASPAR hemostat .....195	DAUBENSPECK curette .....189
applying forceps for bulldog clamps .....83		CASPAR laminectomy forceps .....242, 243	DAVIS brain spatula .....275
applying forceps for clips .....174		CASPAR pusher .....253	DAVIS dissector .....221, 222
applying forceps for scalp clips .....176		CASPAR retractor .....136, 144	DE BAKEY atrauma forceps .....67-69
applying forceps for YASARGIL .....302-305		CASPAR retractor lumbar .....154-157	DE BAKEY bulldog clamp .....80, 81, 82
approximators BIEMER-MÜLLER .....308		CASPAR scalpel blade .....16	DE BAKEY needle holder .....95
approximators MÜLLER .....309, 310		CASTROVIEJO blade breaker .....17	DE BAKEY scissors .....30, 32
atrauma forceps .....67-69		CASTROVIEJO needle holder .....97	DE BAKEY-DIETRICHbulldog clamp .....78
atrauma forceps DE BAKEY .....67-69		CASTROVIEJO scissors .....36	DE BAKEY-HESSbulldog clamp .....82
		cerebellar retractor .....128	DEAVER scissors .....21
<b>B</b>		cervical retractors .....140-146	DEJERINE percussion hammer .....8
BABINSKY percussion hammer .....8		cervical traction tongs .....176	DEMARTEL saw conductor .....177
BACON rongeur .....166		cervical vertebral body distraction system .....158-160	DERRICO nerve root retractor .....113
BADGLEY retractor .....139		chisel STILLE .....196	DEVILBISS skull punch .....178
BANE-HARTMANN rongeur .....164		chisels .....196, 202	DIEFFENBACH bulldog clamp .....83
BARON suction tube .....231		CITELLI punch .....288	DIETRICH bulldog clamp .....78
BARRAQUER needle holder .....96		clamps bulldog .....78-83	DIETRICH scissors .....29, 30
BAUMGARTNER needleholder .....94		clip applicators for open surgery .....319, 320	dilators vessel .....61
BECKMANN retractor .....132		clip rack for clips .....174	dissecting forceps .....88-90
BECKMANN-ADSON retractor .....126, 130		clips ACLAND .....315-317	dissecting scissors .....22-26
BECKMANN-EATON retractor .....132		clips RANEY .....176	dissector CASPAR .....227, 228
BERLINER percussion hammer .....8		clips aneurysm YASARGIL .....290-301	dissector DAVIS .....221, 222
BEYER rongeur .....165, 167		CLOWARD laminectomy forceps .....239	dissector FRAZIER .....223
BIEMER applying forceps .....306, 308, 309, 311		CLOWARD retractor (blade retr.) .....103	dissector GORNEY .....211
BIEMER scissors .....44, 45		CLOWARD retractor cervical .....141, 142, 143	dissector HARDY-FAHLBUSCH .....266
BIEMER vessel clips .....306, 312		CLOWARD retractor lamina .....151, 153	dissector HOEN .....223
BIEMER vessel dilator .....250		COBB curette .....184	dissector HORSLEY .....222
BIEMER vessel spreader .....250		COBB elevator .....217	dissector LANDOLT-REULEN .....270
BIEMER-MÜLLER approximators .....308		COBB gouge .....200	dissector MILLIGAN .....222
bipolar cables .....335		COBB raspatory .....217	dissector OLIVECRONA .....221
bipolar forceps .....328-334		COLCLOUGH rongeur .....286	dissector PENFIELD .....224
blade breaker CASTROVIEJO .....17		CONE cranial punch .....179	dissector SACHS .....221
blade breaker HADEO .....17		CONE curette .....260	dissector TOENNIS .....221
blade breaker TROUTMAN-CHRIS .....17		CONE retractor .....126	dissector WOODSON .....223
blades scalpel .....14-16		COTTLE forceps .....74	dissector YASARGIL .....227
BÖHLER bone cutting forceps .....172		COTTLE hammer .....10	distractor CASPAR .....158
BÖHLER rongeur .....167		COTTLE osteotome .....204	DOYEN raspatory .....212, 213
BOIES elevator .....211		COTTLE-KAZANJIAN bone cutting forceps .....172	dressing forceps .....50-58
bone cutting forceps BÖHLER .....172		cranial punch CONE .....179	drill BUNELL .....325
bone cutting forceps COTTLE-KAZANJIAN .....172		CRILE forceps .....85	drill CUSHING .....324
bone cutting forceps LISTON .....172		CRILE nerve hook .....109	drill HUDSON .....324
bone cutting forceps MCINDOE .....172		CRILE-RANKIN forceps .....85	drill KIRSCHNER .....325
bone cutting forceps RUSKIN-LISTON .....172		CRILE-WOOD needle holder .....94	drill MOORE .....323
bone cutting forceps SEMB .....173		CRUTCHFIELD tong .....176	drill RALK .....326
bone cutting forceps STAMM .....172		curette BRUNS .....188	drill HADEO .....326
bone cutting forceps STILLE-HORSLEY .....173		curette BUSHE .....191	drill STILLE .....322
bone cutting forceps STILLE-LISTON .....173		curette COBB .....184	drill STILLE-SHERMAN .....323
bone cutting forceps STILLE-REULEN .....172-173		curette CONE .....260	drill guide and forceps ADSON .....181
bone graft holder and impactor CASPAR .....194		curette DAUBENSPECK .....189	DUEHRSEN forceps .....55
bore hold protection forceps .....180		curette FAHLBUSCH .....270	dura scissors .....34
brain spatula forceps .....59		curette HALLE .....186	dura hooks .....108-110
brain spatula AACHEN .....274		curette HARDY .....268	
brain spatula CUSHING .....274		curette LANDOLT .....267	
brain spatula DAVIS .....275		curette LANDOLT-REULEN .....270	
brain spatula HEIFETZ .....275		curette LEMBERT .....190	
brain spatula OLIVECRONA .....274		curette NICOLA .....265	
BROPHY forceps .....54		curette HADEO .....190, 191	
		curette SCOVILLE .....187	



Index English



L			
LADOLT pituitary forceps	245	micro pituitary forceps	272
LAMBOTTE osteotome	198	micro ring forceps	66
LAMBOTTE raspatory	207	micro scissors FAHLBUSCH	271
LAMBOTTE-MINI osteotome	199	micro scissors	272
lamina gouge	203	micro scoops	193
lamina spreaders	151-153	MICRO-FRIEDMANN rongeur	162
laminectomy forceps CASPAR	242, 243	MICRO-HARTMANN forceps	83
laminectomy forceps CLOWARD	239	MILLES scissors	44, 45
laminectomy forceps CUSHING	238	MILLIGAN dissector	222
laminectomy forceps FERRIS-SMITH	241	MILLS scissors	29
laminectomy forceps HOEN	240	MISKIMON retractor	128
laminectomy forceps LOVE-GRUENWALD	238	MIXTER-BABY forceps	90
laminectomy forceps SCHLESINGER	239	MOLLISON retractor	122
laminectomy forceps SPURLING	238	MOLT elevator	210
laminectomy forceps WAGNER	241	MOORE drill	323
laminectomy retractors	129-139	MOSQUITO forceps	84
LANDOLT curette	267	MÜLLER approximators	309, 310
LANDOLT enucleator	267		
LANDOLT hook	267	N	
LANDOLT hypophyseal forceps	264	NAGEL scissors	43
LANDOLT scalpel blade	16	nasal forceps WEIL-BLAKESLEY	244
LANDOLT scoop	267	needle holder BARRAQUER	96
LANDOLT spreader	263	needle holder BAUMGARTNER	94
LANDOLT-REULEN curette	270	needle holder CASTROVIEJO	97
LANDOLT-REULEN dissector	270	needle holder CRILE-WOOD	94
LANDOLT-REULEN hook	270	needle holder DE BAKEY	95
LANDOLT-REULEN raspatory	270	needle holder HALSEY	94
LANGENBECK elevator	209	needle holder MAYO-HEGAR	95
LANGENBECK retractor	104, 105	needle holder NEIVERT	94
LAZAR tying forceps	63	needle holder RYDER	95
LEKSELL rongeur	170	needle holder YASARGIL	98
LEMBERT curette	190	needle holders	94-100
LEMPERT rongeur	164, 165	NEIVERT needle holder	94
LEXER gouge	201	nerve and vessel hook KRAYENBÜHL	116
LEXER osteotome	201	nerve dissecting scissors	27
LEXER scissors	22	nerve hook ADSON	110
LEXER-MINI gouge	201	nerve hook CRILE	109
LEXER-MINI osteotome	201	nerve hook CUSHING	109
LEYLA retractor	276-280	nerve hook DANDY	108
ligature forceps	88-90	nerve hook GRAHAM	110
ligature guides YASARGIL	116	nerve hook SACHS	110
ligature guides	116	nerve hook SMITHWICK	110
light ultra forceps	65	nerve hooks	116
LISTON bone cutting forceps	172	nerve hooks	108-110
LITTLE-JOKER elevator	207	nerve root retractor DERRICO	113
LOVE nerve root retractor	113, 114	nerve root retractor HESS	111
LOVE-GRUENWALD laminectomy forceps	238	nerve root retractor HOLSHER	111
LUCAE forceps	74	nerve root retractor LOVE	113, 114
LUER rongeur	163	nerve root retractor SCOVILLE	111, 114
lumbal retractor	154-157	nerve root retractors	111-114
		NICOLA curette	265
M		NICOLA micro forceps	271
MARKHAM-MEYERDING retractor	148	NICOLA raspatory	265
MARQUARDT rongeur	168	NORFOLK/NORWICH retractor	124
MARTEL forceps	87		
MATSON raspatory	213	O	
MATSON-ALEXANDER raspatory	213	OKONEK-YASARGIL tumor fork	254
MAYFIELD rongeur	167	OLDBERG pituitary forceps	245
MAYO forceps	58	OLIVECRONA brainspatula	274
MAYO scissors	22	OLIVECRONA dissector	221
MAYO-ADAMS retractor	124	OLIVECRONA rongeur	164
MAYO-HEGAR needle holder	95	OLIVECRONA scissors	33
MAYO-STILLE scissors	22	OLIVECRONA wire saw	177
MCDONALD elevator	219	OLIVECRONA-TOENNIS forceps applying	174
MCINDOE bone cutting forceps	172	OMBREDANNE hammer	10
MCINDOE forceps	55	operating scissors	20-21
MCKENZIE forceps applying	174	osteotome COTTLE	204
MEHDORN applying forceps	307	osteotome LAMBOTTE	198
MEHDORN vessel clips	307	osteotome LAMBOTTE-MINI	199
METZENBAUM scissors	23-25	osteotome LEXER	201
MEYERDING retractor	106, 148	osteotome LEXER-MINI	201
MICHELE trephine	182	osteotome SMITH-PETERSEN	197
micro scissors	35-46	osteotome STILLE	196
micro cup-shaped for ceeps	272		
micro forceps NICOLA	271	P	
micro forceps YASARGIL	75	PAPAVERO-CASPAR speculum	264
micro instruments RHOTON	256	PAPAVERO-HARTMANN spreader	264
micro mirror HARDY	269	PENFIELD dissector	224
micro needle holders	96-100	percussion hammer BABINSKY	8
		percussion hammer BERLINER	8
		percussion hammer BUCK	8
		percussion hammer DEJERINE	8
		percussion hammer TAYLOR	8
		percussion hammer TROEMNER	8
		pin wheel WARTENBERG	11
		pituitary forceps LADOLT	245
		pituitary forceps OLDBERG	245
		pituitary forceps YASARGIL	245
		plastic hammer	9
		PLESTER retractor	122, 124
		PLESTER suction tube	233
		POTTS DE-MARTEL scissors	29
		POTTS-SMITH forceps	50
		POTTS-SMITH scissors	30, 31
		POTTS-YASARGIL scissors	44, 45
		probe JACOBSON	249
		probe KOOS	249
		punch CITELLI	288
		punch HAJEK-KOFLER	287, 288
		punch KERRISON	287
		pusher CASPAR	253
		pusher JACOBSON	253
		Q	
		QUERVAIN elevator	208
		R	
		RALK drill	326
		RANEY clips	176
		RANEY forceps applying	176
		raspatory ADSON	218
		raspatory COBB	217
		raspatory DOYEN	212, 213
		raspatory FARABEUF	206
		raspatory FARABEUF-COLLIN	206, 207
		raspatory JANSEN	206
		raspatory KEY	218
		raspatory LAMBOTTE	207
		raspatory LANDOLT-REULEN	270
		raspatory MATSON	213
		raspatory MATSON-ALEXANDER	213
		raspatory NICOLA	265
		raspatory SELDIN	211
		raspatory YASARGIL	225, 226
		HADEO blade breaker	17
		HADEO curette	190, 191
		HADEO drill	326
		HADEO handle saw	177
		retractor ADSON	125, 126, 129
		retractor ALM	120
		retractor ANDERSON-ADSON	128
		retractor BADGLEY	139
		retractor BECKMANN	132
		retractor BECKMANN-ADSON	126, 130
		retractor BECKMANN-EATON	132
		retractor CASPAR	136, 144
		retractor CONE	126
		retractor CUSHING	103
		retractor DARLING	147
		retractor GELPI	150
		retractor HARVEY-JACKSON	133
		retractor HENLEY	123
		retractor HOLZHEIMER	120
		retractor INGE	152
		retractor JANSEN	120
		retractor KNIGHTON	134
		retractor KOCHER	105
		retractor KOCHER-LANGENBECK	104
		retractor LANGENBECK	104, 105
		retractor LEYLA	276-280
		retractor lumbal	154-157
		retractor MARKHAM-MEYERDING	148
		retractor MAYO-ADAMS	124
		retractor MEYERDING	106, 148
		retractor MISKIMON	128
		retractor MOLLISON	122
		retractor NORFOLK/NORWICH	124
		retractor PLESTER	122, 124
		retractor SCALP-CONTOUR	127
		retractor SCOVILLE	137



retractor SCOVILLE-HAFERFIELD.....	137	scissors iris.....	27	STILLE-HORSLEY bone cutting forceps.....	173
retractor SCOVILLE-RICHTER.....	138	scissors JACOBSON.....	44, 45	STILLE-LISTON bone cutting forceps.....	173
retractor TRAVERS.....	125	scissors JAMESON-WERBER.....	26	STILLE-LUER rongeur.....	169
retractor WALTON.....	135	scissors KELLY.....	21	STILLE-RUSKIN rongeur.....	169
retractor WEITLANER.....	121	scissors KILNER.....	26	STILLE-SHERMAN drill.....	323
retractor WEITLANER-WULLSTEIN.....	121	scissors LEXER.....	22	STRULLY scissors.....	33
retractor WILLIAMS.....	149	scissors MAYO.....	22	suction adapter HOUSE.....	231
retractor WULLSTEIN.....	122	scissors MAYO-STILLE.....	22	suction cannula micro.....	234
retractor (blade retr.) CLOWARD.....	103	scissors METZENBAUM.....	23-25	suction raspatory GUILLEN.....	235
retractor cervical CLOWARD.....	141, 142, 143	scissors micro.....	35-46	suction tube ADSON.....	230
retractor lamina CLOWARD.....	151, 153	scissors MILLESI.....	44, 45	suction tube BARON.....	231
retractor lumbar CASPAR.....	154-157	scissors MILLS.....	29	suction tube FERGUSSON.....	230, 231
retractors.....	102-160	scissors NAGEL.....	43	suction tube FRAZER.....	231
REYNOLDS scissors.....	26	scissors nerve dissecting.....	27	suction tube HOUSE.....	233
RHOTON micro instruments.....	256	scissors OLIVECRONA.....	33	suction tube PLESTER.....	233
rib scissors.....	48	scissors operating.....	20-21	suction tube SCHUKNECHT.....	231
rib shears.....	48	scissors POTTS DE-MARTEL.....	29	suction tube WULLSTEIN.....	234
ring forceps micro.....	66	scissors POTTS-SMITH.....	30, 31	suction tube YASARGIL.....	232
RÖGER elevator.....	220	scissors POTTS-YASARGIL.....	44, 45	suction tube ZÖLLNER.....	232
rongeur ADSON.....	163	scissors REYNOLDS.....	26	SWEET forceps applying.....	174
rongeur BACON.....	166	scissors rib.....	48		
rongeur BANE-HARTMANN.....	164	scissors SCHMIEDEN-TAYLOR.....	34	T	
rongeur BEYER.....	165, 167	scissors STEVENS.....	28	tape measure.....	11
rongeur BÖHLER.....	167	scissors STRULLY.....	33	TAYLOR forceps.....	58
rongeur COLCLOUGH.....	286	scissors TOENNIS-ADSON.....	27	TAYLOR percussion hammer.....	8
rongeur ECHLIN.....	171	scissors TOENNIS.....	33	TAYLOR spinal retractor.....	107
rongeur FERRIS-SMITH-KERRISON.....	282-285	scissors trigeminus.....	47	TAYLOR valve.....	137
rongeur FRIEDMANN mini.....	162	scissors tumor.....	34	Tendon grasping forceps.....	92
rongeur FRYKHOLM.....	171	scissors UNIVERSAL.....	37, 42, 44, 45	tissue forceps.....	50-58
rongeur JANSEN.....	164	scissors VANNAS.....	29-32	tissue pick.....	255
rongeur KLEINERFKUTZ.....	165	scissors vascular.....	41, 42, 44, 45	TOENNIS dissector.....	221
rongeur LEKSELL.....	170	scissors YASARGIL.....	270	TOENNIS forceps.....	91
rongeur LEMPERS.....	164, 165	scoop FAHLBUSCH.....	267	TOENNIS-ADSON scissors.....	27
rongeur LUER.....	163	SCOVILLE curette.....	187	tong CRUTCHFIELD.....	176
rongeur MARQUARDT.....	168	SCOVILLE nerve root retractor.....	111, 114	TRAVIS retractor.....	125
rongeur MAYFIELD.....	167	SCOVILLE retractor.....	137	tray for aneurysm clips and for cepts.....	313, 314
rongeur MICRO-FRIEDMANN.....	162	SCOVILLE spatula forceps.....	59	trephine MICHELE.....	162
rongeur OLIVECRONA.....	164	SCOVILLE valve.....	137	trigemineus scissors.....	33
rongeur RUSKIN.....	168	SCOVILLE-HAFERFIELD retractor.....	137	TROEMNER percussion hammer.....	8
rongeur SAUERBRUCH.....	170	SCOVILLE-RICHTER retractor.....	138	TROUTMAN-CHRIS blade breaker.....	17
rongeur SEMB.....	171	SEBILAU elevator.....	208	tumor forceps.....	70-73
rongeur SMITH-PETERSEN.....	166	SEDILLOT elevator.....	207, 208	tumor scissors.....	47
rongeur STELLBRINK.....	162	SELDIN raspatory.....	211	tumor forceps HEIFETZ.....	72
rongeur STILLE.....	170	SEMB bone cutting for cepts.....	173	tumor forceps HUNT.....	71
rongeur STILLE-LUER.....	169	SEMB rongeur.....	171	tumor forceps SAMII.....	73
rongeur STILLE-RUSKIN.....	169	SEMKEN forceps.....	56	tumor forceps YASARGIL.....	72
rongeur ZAUFAL-JANSEN.....	167	SEWALL elevator.....	219	tumor forceps YASARGIL-SAMII.....	72
rongeurs.....	162-171	shears rib.....	48	tumor fork OKONEK-YASARGIL.....	254
ruler.....	11	skin hook FRAZIER.....	102	tumor fork YASARGIL.....	257
RUSKIN rongeur.....	168	skin hook FREER.....	102	tumor grasping forceps.....	91
RUSKIN-LISTON bone cutting forceps.....	172	skin hook GILLIES.....	102	tuning fork.....	11
RYDER needle holder.....	95	skin hook JOSEPH.....	102	tying forceps micro.....	62-64
		skull punch DEVILBISS.....	178	tying forceps LAZAR.....	63
S		skull trephine GALT.....	181	tying forceps VISE.....	64
SACHS dissector.....	221	SMITH-PETERSEN gouge.....	197		
SACHS nerve hook.....	110	SMITH-PETERSEN osteotome.....	197	U	
SAMII knife.....	251, 252	SMITH-PETERSEN rongeur.....	166	ultra-light forceps.....	65
SAMII tumor forceps.....	73	SMITHWICK forceps applying.....	174	UNIVERSAL scissors.....	34
SAUERBRUCH rongeur.....	170	SMITHWICK nerve hook.....	110		
saw conductor DEMARTEL.....	177	spatula forceps brain.....	59	V	
scalp forceps.....	87	spatula forceps SCOVILLE.....	59	valve SCOVILLE.....	137
scalp hemostasis clips.....	176	speculum CUSHING-LANDOLT.....	263	valve TAYLOR.....	137
scalp retractor.....	127	speculum PAPAVERO-CASPAR.....	264	VANNAS scissors.....	37, 42, 44, 45
SCALP-CONTOUR retractor.....	127	SPINAL curette.....	186, 187	vascular scissors.....	29-32
scalpel blades.....	14-16	spinal hook.....	107	vessel dilators.....	61
scalpel blade CASPAR.....	16	spinal retractor TAYLOR.....	107	vessel clips BIEMER.....	306, 312
scalpel blade LANDOLT.....	16	spoon HARDY.....	269	vessel clips MEHDORN.....	307
SCHLESINGER laminectomy forceps.....	239	SPRATT curette.....	184	vessel dilator BIEMER.....	250
SCHMIEDEN-TAYLOR scissors.....	34	spreader LANDOLT.....	263	vessel hooks.....	116
SCHUKNECHT suction tube.....	231	spreader PAPAVERO-HARTMANN.....	264	vessel knife and hook interchangeable.....	117
scissors BIEMER.....	44, 45	spreaders and retractors.....	120-160	vessel spreader BIEMER.....	250
scissors CASTROVIEJO.....	36	SPURLING laminectomy forceps.....	238	VISE tying forceps.....	64
scissors DANDY.....	33	STAMM bone cutting forceps.....	172	VOKMANN curette double.....	192
scissors DE BAKEY.....	30, 32	STELLBRINK rongeur.....	162	VOLKMANN curette.....	184
scissors DEEVER.....	21	STEVENS scissors.....	28		
scissors DIETRICH.....	29, 30	STILLE chisel.....	196		
scissors dissecting.....	22-26	STILLE drill.....	322		
scissors dura.....	34	STILLE gouge.....	196		
scissors FAVALORO.....	31	STILLE osteotome.....	196		
scissors GRADLE.....	28	STILLE rongeur.....	170		

## Index English

W	
WAGNER elevator.....	217
WAGNER hammer.....	10
WAGNER laminectomy forceps.....	241
WALTON retractor.....	135
WANGENSTEEN forceps.....	58
WARTENBERG pin wheel.....	11
WATSON-CHEYNE elevator.....	219
WAUGH forceps.....	53
WEIL-BLAKESLEY nasal forceps.....	244
WEITLANER retractor.....	121
WEITLANER-WULLSTEIN retractor.....	121
WILLET MARTEL forceps.....	87
WILLIAMS retractor.....	149
WILLIGER elevator.....	210
WILLIGER hammer.....	9
wire saws.....	177
wire saws OLIVECRONA.....	177
WOODSON dissector.....	223
WULLSTEIN retractor.....	122
WULLSTEIN suction tube.....	234
Y	
YASARGIL clips aneurysm.....	290-301
YASARGIL dissector.....	227
YASARGIL galea hook.....	114
YASARGIL knife.....	248
YASARGIL ligature guides.....	116
YASARGIL micro forceps.....	75
YASARGIL needle holder.....	98
YASARGIL pituitary forceps.....	245
YASARGIL raspatory.....	225, 226
YASARGIL scissors.....	41, 42, 44, 45
YASARGIL suction tube.....	232
YASARGIL tumor forceps.....	72
YASARGIL tumor fork.....	257
YASARGIL-NICOLA grasping forceps.....	271
YASARGIL-SAMIL tumor forceps.....	72
Z	
ZAUFAL-JANSEN rongeur.....	167
ZIELKE gouge.....	202
ZOLLNER suction tube.....	232

<b>A</b>		<b>BROWN</b> pinza de diseccion .....	53	<b>CRILE-WOOD</b> porta aguja .....	94
AACHEN	espatula cerebral .....	<b>BROWN-ADSON</b> pinza de diseccion .....	52	<b>CRUTCHFIELD</b> pinza de traccion craneal .....	176
ACLAND	aproximador .....	<b>BRUNS</b> cucharilla cortante .....	188	<b>cuchara</b> .....	184-192, 256, 267, 269, 270
ACLAND	micro clip vascular .....	<b>BUCK</b> martillo de percusion .....	8	<b>cucharilla</b> .....	184-192, 256, 267, 269, 270
ACLAND	pinza aplicadora .....	<b>bulldog clamp</b> .....	78-82	<b>cucharilla cortante BRUNS</b> .....	188
ADAMS-MAYO	separador .....	<b>bulldog clamp DE BAKEY</b> .....	80-82	<b>cucharilla cortante BUSHE</b> .....	191
adaptador	HOUSE .....	<b>bulldog clamp DE BAKEY-HESS</b> .....	82	<b>cucharilla cortante COBB</b> .....	185
adaptador para aspiracion	.....	<b>bulldog clamp DIETRICH</b> .....	78	<b>cucharilla cortante DAUBENSPECK</b> .....	189
ADLERKREUTZ	pinza de diseccion .....	<b>bulldog clamp GLOVER</b> .....	80-81	<b>cucharilla cortante HALLE</b> .....	186
ADSON ANDERSON	separador para cerebello .....	<b>BUNELL</b> perforador de mano .....	325	<b>cucharilla cortante JANSEN</b> .....	192
ADSON	elevador .....	<b>BUSHE</b> cucharilla cortante .....	191	<b>cucharilla cortante LEMPERS</b> .....	190
ADSON	gancho .....			<b>cucharilla cortante HADEO</b> .....	190-191
ADSON	pinza de diseccion .....	<b>C</b>		<b>cucharilla cortante SCOVILLE</b> .....	187
ADSON	pinza gubia .....	<b>cable bipolar</b> .....	335	<b>cucharilla cortante SPINAL</b> .....	186-187
ADSON	pinza guia taladros y protectora de duramadre .....	<b>CAJA</b> .....	338-343	<b>cucharilla cortante SPRATT</b> .....	184
ADSON	pinza para hipofisis .....	<b>calibrador</b> .....	11	<b>cucharilla cortante VOLKMANN</b> .....	184, 192
ADSON	separador .....	<b>canula para mango de aspiracion</b> .....	232, 234	<b>cucharilla FAHLBUSCH</b> .....	270
ADSON	separador para laminectomia .....	<b>CAROLL</b> pinza para tendones .....	92	<b>cucharilla HARDY</b> .....	269
ADSON	tubo de aspiracion .....	<b>CASPAR</b> empujador de sutura .....	253	<b>cucharilla LANDOLT</b> .....	267
ADSON-BABY	pinza .....	<b>CASPAR</b> gancho para exploracion y coagulacion .....	115	<b>cucharilla micro</b> .....	193, 256
ADSON-BECKMANN (CONE)	separador .....	<b>CASPAR</b> hemostatico .....	195	<b>cucharilla micro YASARGIL</b> .....	193
ADSON-BECKMANN	separador para laminectomia .....	<b>CASPAR</b> injerto osoo titular y impactador .....	194	<b>cucharilla RHOTON</b> .....	256
ADSON-BROWN	pinza de diseccion .....	<b>CASPAR</b> mango de bisturi .....	16	<b>cucharilla RHOTON</b> .....	256
ADSON-DE BAKEY	pinza de diseccion .....	<b>CASPAR</b> micro disector .....	227-228	<b>cucharillas cortantes</b> .....	184-192, 256, 267, 269, 270
ADSON-TOENNIS	tijera de diseccion .....	<b>CASPAR</b> pinza para laminectomia .....	242-243	<b>cuchillo JACOBSON</b> .....	117, 118
aguja	RHOTON .....	<b>CASPAR</b> separador cervical .....	144	<b>cuchillo micro KOOS</b> .....	248-249
alargadera	pieza .....	<b>CASPAR</b> separador lumbar .....	154-156	<b>cuchillo micro YASARGIL</b> .....	248
ALEXANDER	periototomo .....	<b>CASPAR</b> separador para laminectomia .....	136	<b>cuchillo para tumores SAMIL</b> .....	251-252
ALEXANDER-MATSON	periototomo .....	<b>CASPAR</b> separador para nervios .....	112	<b>cureta</b> .....	260, 262, 265, 268, 270
ALM	separador .....	<b>CASPAR</b> sistema de distraccion vertebral .....	158	<b>cureta CONE</b> .....	260
ANDERSON	ADSON separador para cerebello .....	<b>CASPAR-PAPAVERO</b> espejuelo para hipofisectomia .....	264	<b>cureta FAHLBUSCH</b> .....	270
aplicadora	pinza .....	<b>CASTROVIEJO</b> mico porta aguja .....	97	<b>cureta HARDY</b> .....	268
aproximador	.....	<b>CASTROVIEJO</b> micro tijera .....	36	<b>cureta LANDOLT</b> .....	267
aproximador	ACLAND .....	<b>CASTROVIEJO</b> rompe-hojas .....	17	<b>cureta LANDOLT-REULEN</b> .....	270
aproximador	BIEMER .....	<b>CHEYNE-WATSON</b> elevador .....	219	<b>cureta NICOLA</b> .....	265
aproximador	BIEMER-MÜLLER .....	<b>CHRIS-TROUTMAN</b> rompe-hojas .....	17	<b>CUSHING (LITTLE-JOKER)</b> periototomo .....	207
aproximador	MÜLLER .....	<b>cincel</b> .....	196, 202	<b>CUSHING</b> broca .....	324
Atomizador	.....	<b>cincel STILLE</b> .....	196	<b>CUSHING</b> espatula cerebral .....	274
AUSTIN	micro pinza .....	<b>CITELLI</b> pinza .....	288	<b>CUSHING</b> fresca .....	324
		<b>clamp bulldog</b> .....	78-82	<b>CUSHING</b> gancho .....	109
<b>B</b>		<b>clamp bulldog DE BAKEY</b> .....	80-82	<b>CUSHING</b> periototomo .....	207, 208
BABINSKY	martillo de percusion .....	<b>clamp bulldog DE BAKEY-DIETRICH</b> .....	78	<b>CUSHING</b> pinza de diseccion .....	53
BABY MIXTER	pinza hemostatica .....	<b>clamp bulldog DE BAKEY-HESS</b> .....	82	<b>CUSHING</b> pinza para laminectomia .....	238
BABY-ADSON	pinza .....	<b>clamp bulldog DIETRICH</b> .....	78	<b>CUSHING</b> separador .....	103
BABY-METZENBAUM	BLACK tijera de diseccion .....	<b>clamp bulldog GLOVER</b> .....	80-81	<b>CUSHING</b> taladro .....	324
BACON	pinza gubia .....	<b>Clip</b> .....	176	<b>CUSHING-LANDOLT</b> espejuelo para hipofisectomia .....	263
BADGLEY	separador para laminectomia .....	<b>clip micro vascular</b> .....	312	<b>CUSHING-TAYLOR</b> pinza de diseccion .....	57
BANE-HARTMANN	pinza gubia .....	<b>clip para aneurisma</b> .....	290-301		
BARON	tubo de aspiracion .....	<b>clip para aneurisma YASARGIL</b> .....	290-301	<b>D</b>	
BARRAQUER	micro porta aguja .....	<b>clip para vasos</b> .....	306-307, 310	<b>DANDY</b> gancho .....	108
BAUMGARTNER	porta aguja .....	<b>clip para vasos BIEMER</b> .....	306	<b>DANDY</b> pinza hemostatica .....	86
BECKMANN	separador para laminectomia .....	<b>clip para vasos MEHDORN</b> .....	307	<b>DANDY</b> tijera para trigemino .....	33
BECKMANN-ADSON (CONE)	separador .....	<b>clip para vasos MÜLLER</b> .....	310	<b>DARLING</b> separador para hemilaminectomia .....	147
BECKMANN-ADSON	separador para laminectomia .....	<b>clip vascular</b> ACLAND .....	315-317	<b>DAUBENSPECK</b> cucharilla cortante .....	189
BECKMANN-EATON	separador para laminectomia .....	<b>clip vascular micro</b> .....	312	<b>DAVIS</b> disector .....	221-222
BERLINER	martillo de percusion .....	<b>CLOWARD</b> pinza para laminectomia .....	239	<b>DAVIS</b> espatula cerebral .....	275
BEYER	pinza gubia .....	<b>CLOWARD</b> separador cervical .....	140-143	<b>DE BAKEY</b> clamp bulldog .....	80-82
BIEMER	aproximador .....	<b>CLOWARD</b> separador de hoja .....	103	<b>DE BAKEY</b> micro pinza .....	67
BIEMER	clip para vasos .....	<b>CLOWARD</b> separador para vertebrales .....	151, 153	<b>DE BAKEY</b> pinza .....	68-69
BIEMER	micro tijera .....	<b>coagulacion bipolar</b> .....	328-333	<b>DE BAKEY</b> porta aguja .....	95
BIEMER	pinza aplicadora .....	<b>COBB</b> cucharilla cortante .....	185	<b>DE BAKEY</b> tijera vascular .....	30-32
BIEMER	separador para vasos .....	<b>COBB</b> gubia .....	200	<b>DE BAKEY-ADSON</b> pinza de diseccion .....	51
BIEMER-MÜLLER	aproximador .....	<b>COBB</b> periototomo .....	217	<b>DE BAKEY-DIETRICH</b> clamp bulldog .....	78
bipolar	cable .....	<b>COLCLOUGH</b> pinza para sacabocado para discos .....		<b>DE BAKEY-HESS</b> clamp bulldog .....	82
bipolar	coagulacion .....	<b>intervertebrales</b> .....	286	<b>DE MARTEL-POTTS</b> tijera vascular .....	29
bipolar	pinza .....	<b>COLLIN-FARABEUF</b> periototomo .....	206-207	<b>DE AVER</b> tijera para cirugia .....	21
bipolar	pinza de succion .....	<b>CONE</b> cureta .....	260	<b>DE JERINE</b> martillo de percusion .....	8
bipolar	pinza non-stick .....	<b>CONE</b> pinza sacabocado craneal .....	179	<b>DeMARTEL</b> guia-conductora .....	177
bisturi	.....	<b>contenedor para esterilizacion y almacenaje</b> .....	313-314	<b>D'ERRICO</b> separador para nervios .....	113
BLACK	METZENBAUM tijera de diseccion .....	<b>CONTOUR-SCALP</b> separador para el cuero cabelludo .....	127	<b>DeVILBISS</b> pinza sacabocado craneal .....	178
BLACK	tijera de diseccion .....	<b>costotomo GIERTZ-STILLE</b> .....	48	<b>diapason</b> .....	11
BLAKESLEY-WEIL	pinza para laminectomia .....	<b>costotomo SAUERBRUCH</b> .....	48	<b>DIEFFENBACH</b> serra-fina .....	83
BÖHLER	pinza cortante para huesos .....	<b>costotomo SAUERBRUCH-FREY</b> .....	48	<b>DIETRICH</b> clamp bulldog .....	78
BÖHLER	pinza gubia .....	<b>COTTLE</b> martillo .....	10	<b>DIETRICH</b> tijera vascular .....	29-30
BOIES	elevador .....	<b>COTTLE</b> osteotomo .....	204	<b>DIETRICH-DE BAKEY</b> clamp bulldog .....	78
broca	.....	<b>COTTLE</b> pinza .....	74	<b>dilatador vascular</b> .....	61, 250
broca	CUSHING .....	<b>COTTLE-KAZANJIAN</b> pinza cortante para huesos .....	172	<b>disector</b> .....	206-224, 256, 266, 270
broca	ERRICO .....	<b>CRILE</b> gancho .....	109	<b>disector SACHS</b> .....	221
broca	MC KENZIE .....	<b>CRILE</b> pinza hemostatica .....	85	<b>disector TOENNIS</b> .....	221
BROPHY	pinza de diseccion .....	<b>CRILE-RANKIN</b> pinza hemostatica .....	85	<b>disector DAVIS</b> .....	221-222



## Indice Español

**HADEO**  
 INSTRUMENTE GERMANY

disector FRAZIER.....	223	FRIEDMANN MICRO pinza gubia.....	162	HOEN disector.....	223
disector GORNEY.....	211	FRIEDMANN MINI pinza gubia.....	162	HOEN periostotomo.....	209
disector HOEN.....	223	FRIEDMANN pinza gubia.....	162	HOEN pinza para laminectomia.....	240
disector HORSLEY.....	222	FRYKHOLM pinza gubia.....	171	hoja SCOVILLE.....	137
disector LANDOLT-REULEN.....	270	FUCHSIG pinza.....	88	hoja TAYLOR.....	137
disector micro CASPAR.....	227-228			hojas.....	136-138, 140-146, 156-157
disector micro YASARGIL.....	227	<b>G</b>		HOLSHER separador para nervios.....	111
disector MILLIGAN.....	222	GALT trepano craneal.....	181	HOLZHEIMER separador.....	120
disector OLIVECRONA.....	221	gancho.....	102, 108-110, 114-118, 249, 256, 267, 270	HOPKINS-JOHNS serra-fina.....	83
disector PENFIELD.....	224	gancho ADSON.....	110	horquilla de implante HARDY.....	266
disector RHOTON.....	256	gancho CRILE.....	109	horquilla para tumores.....	254, 257
disector WOODSON.....	223	gancho CUSHING.....	109	horquilla para tumores OKONEY-YASARGIL.....	254
DONALD MC elevador.....	219	gancho DANDY.....	108	horquilla para tumores YASARGIL.....	257
DOYEN periostotomo.....	212-213	gancho FISCH.....	118, 249	HORSLEY disector.....	222
DUEHRSEN pinza de diseccion.....	55	gancho FRAZIER.....	102	HORSLEY-STILLE pinza cortante para huesos.....	173
		gancho FREER.....	102	HOSOBUCHI espátula.....	267
<b>E</b>		gancho GILLIES.....	102	HOUSE adaptador.....	231
EATON-BECKMANN separador para laminectomia.....	132	gancho GRAHAM.....	110	HOUSE tubo de aspiracion.....	233
ECHLIN pinza gubia.....	171	gancho JOSEPH.....	102	HUDSON perforador de mano.....	324
elevador.....	206-220	gancho LANDOLT.....	267	HUNT pinza para tumores y tejido.....	70-71
elevador ADSON.....	218	gancho LANDOLT-REULEN.....	270		
elevador BOIES.....	211	gancho para coagulacion y exploracion CASPAR.....	115	<b>I</b>	
elevador FREER.....	220	gancho para duramadre FISCH.....	118, 249	impactador y injerto oseos titular CASPAR.....	194
elevador JOSEPH.....	219	gancho para exploracion y coagulacion CASPAR.....	115	INDOE MC pinza cortante para huesos.....	172
elevador KEY.....	218	gancho para galea YASARGIL.....	114	INDOE MC pinza de diseccion.....	55
elevador MC DONALD.....	219	gancho para nervios y vasos KRAYENBÜHL.....	116	INGE separador para vertebrales.....	152
elevador QUERVAIN.....	208	gancho para vasos y nervios KRAYENBÜHL.....	116	injerto oseos titular y impactador CASPAR.....	194
elevador ROGER.....	220	gancho RHOTON.....	256	IRIS tijera.....	27
elevador SEBILEAU.....	208	gancho SACHS.....	110		
elevador SEWALL.....	219	gancho SCOVILLE.....	137	<b>J</b>	
elevador WATSON-CHEYNE.....	219	gancho SMITHWICK.....	110	JACKSON-HARVEY separador para laminectomia.....	133
empujador de sutura CASPAR.....	253	garra para tejido.....	255	JACOBSON cuchillo.....	117, 118
empujador de sutura JACOBSON.....	253	GELPI separador.....	150	JACOBSON empujador de sutura.....	253
enucleador.....	266-267	GEMINI pinza.....	89	JACOBSON micro tijera.....	44-45
enucleador HARDY.....	266	GERALD pinza de diseccion.....	56-57	JACOBSON pinza hemostatica.....	84
enucleador LANDOLT.....	267	GIERTZ-STILLE costotomo.....	48	JACOBSON sonda.....	249
EQUIPO.....	338-343	GIGLI mango para sierra.....	177	JAMESON WEBBER tijera dediseccion.....	26
ERRICO broca.....	324	GIGLI STRULLY mango para sierra.....	177	JANSEN cuchara cortante.....	192
ERRICO fresa.....	324	GILLIES gancho.....	102	JANSEN periostotomo.....	206
ERRICO taladro.....	324	GILLIES pinza de diseccion.....	56	JANSEN pinza.....	74
espátula cerebral.....	274-275	GLOVER clamp bulldog.....	80-81	JANSEN pinza gubia.....	164
espátula cerebral AACHEN.....	274	GORNEY disector.....	211	JANSEN separador.....	120
espátula cerebral CUSHING.....	274	GRADLE tijera.....	28	JANSEN-GRUENWALD pinza.....	74
espátula cerebral DAVIS.....	275	GRAHAM gancho.....	110	JANSEN-ZAUFAL pinza gubia.....	167
espátula cerebral HEIFETZ.....	275	GRUENWALD-JANSEN pinza.....	74	JOHNS-HOPKINS serra-fina.....	83
espátula cerebral OLIVECRONA.....	274	GRUENWALD-LOVE pinza para laminectomia.....	238	JOSEPH elevador.....	219
espátula HOSOBUCHI.....	267	gubia.....	196-197, 200-203	JOSEPH gancho.....	102
espátula-pinza SCOVILLE.....	59	gubia COBB.....	200	JOSEPH periostotomo.....	211
especulo para hipofisectomia CUSHING-LANDOLT.....	263	gubia LEXER.....	201		
especulo para hipofisectomia PAPAVERO-CASPAR.....	264	gubia LEXERMINI.....	201	<b>K</b>	
espejo micro HARDY.....	269	gubia SMITH-PETERSEN.....	197	KAZANJIAN-COTTLE pinza cortante para huesos.....	172
		gubia STILLE.....	196	KELLY pinza hemostatica.....	85
<b>F</b>		gubia ZIELKE.....	202	KELLY tijera para cirugia.....	21
FAHLBUSCH cucharilla.....	270	guia telescopica.....	325	KELLY-RANKIN pinza hemostatica.....	85
FAHLBUSCH cureta.....	270	guia-conductora DeMARTEL.....	177	KENZIE MC broca.....	324
FAHLBUSCH micro tijera.....	271	guiador YASARGIL.....	116	KENZIE MC fresa.....	324
FARABEUF periostotomo.....	206	GUILEN legra de aspiracion.....	235	KENZIE MC pinza aplicadora.....	174
FARABEUF-COLLIN periostotomo.....	206-207			KENZIE MC taladro.....	324
FAVALORO tijeravascular.....	32	<b>H</b>		KERRISON pinza.....	287
FERGUSON tubo de aspiracion.....	230	HAJEK-KOFLER pinza.....	287-288	KEY elevador.....	218
FERGUSON-FRAZIER tubo de aspiracion.....	231	HALLE cucharilla cortante.....	186	KILNER tijera de diseccion.....	26
FERGUSON-FRAZIER tubo de depuncion.....	231	HALSEY porta aguja.....	94	KIRSCHNER perforador de mano.....	325
FERRIS-SMITH pinza para laminectomia.....	241	HALSTED-MOSQUITO pinza hemostatica.....	84	KLEINERT-KUTZ pinza gubia.....	165
FERRIS-SMITH-KERRISON pinza sacabocado para discos intervertebrales.....	282-285	HARDY cucharilla.....	269	KNIGHTON separador para laminectomia.....	134
FINO METZENBAUM tijera de diseccion.....	23	HARDY cureta.....	268	KOCHER separador.....	105
FISCH gancho.....	118, 249	HARDY enucleador.....	266	KOCHER-LANGENBECK separador.....	104
FISCH gancho para duramadre.....	118, 249	HARDY horquilla de implante.....	266	KOFLER-HAJEK pinza.....	287-288
FOMON periostotomo.....	211	HARDY micro espejo.....	269	KÖNIG periostotomo.....	210
FRAZIER disector.....	223	HARTMANN pinza hemostatica.....	83	KOOS micro cuchillo.....	248-249
FRAZIER gancho.....	102	HARTMANN-BANE pinza gubia.....	164	KRAYENBÜHL gancho para nervios y vasos.....	116
FRAZIER/FERGUSON tubo de aspiracion.....	231	HARTMANN-PAPAVERO pinza para especulo.....	264	KUTZ-KLEINERT pinza gubia.....	165
FRAZIER/FERGUSON tubo de depuncion.....	231	HARVEY-JACKSON separador para laminectomia.....	133		
FREER elevador.....	220	HAVERFIELD-SCOVILLE separador para laminectomia.....	137		
FREER gancho.....	102	HEGAR-MAYO porta aguja.....	95		
fresa.....	160, 176, 322-324	HEIFETZ espátula cerebral.....	275		
fresa CUSHING.....	324	HEIFETZ pinza para tumores y tejido.....	72		
fresa ERRICO.....	324	hemostatico.....	195		
fresa MC KENZIE.....	324	hemostatico CASPAR.....	195		
FREY-SAUERBRUCH costotomo.....	48	HENLEY separador.....	123		
		HESS separador para nervios.....	111		

L					
LAMBOTTE osteotomo	198	MAYO-HEGAR porta aguja	95	O	
LAMBOTTE periostotomo	207	MAYO-STILLE tijera de diseccion	22	OKONEY-YASARGIL horquilla para tumores	254
LAMBOTTE-MINI osteotomo	199	MC DONALD elevador	219	OLDBERG pinza para laminectomia	245
LANDOLT cucharilla	267	MC INDOE pinza cortante para huesos	172	OLIVECRONA disector	221
LANDOLT cureta	267	MC KENZIE broca	324	OLIVECRONA espátula ceebral	274
LANDOLT enucleador	267	MC KENZIE fresa	324	OLIVECRONA pinza gubia	164
LANDOLT gancho	267	MC KENZIE taladro	324	OLIVECRONA sierra	177
LANDOLT mango de bisturi	16	McINDOE pinza de diseccion	55	OLIVECRONA tijera paratrigemino	33
LANDOLT pinza	264	McKENZIE pinza aplicadora	174	OLIVECRONA-TOENNIS pinza aplicadora	174
LANDOLT pinza para especulo	263	MEHDORN clip para vasos	307	OMBREDANNE martillo	10
LANDOLT pinza para laminectomia	245	MEHDORN pinza aplicadora	307	osteotomo MINI-LAMBOTTE	199
LANDOLT-CUSHING especulo para hipofisectomia	263	METZENBAUM BLACK tijera de diseccion	24-25	osteotomo	196-199, 201, 204
LANDOLT-REULEN cureta	270	METZENBAUM FINO tijera de diseccion	23	osteotomo COTTLE	204
LANDOLT-REULEN disector	270	METZENBAUM tijera de diseccion	23	osteotomo LAMBOTTE	198
LANDOLT-REULEN gancho	270	METZENBAUM-BABY BLACK tijera de diseccion	25	osteotomo LEXER	201
LANDOLT-REULEN legra	270	MEYERDING separador	106	osteotomo LEXER MINI	201
LANDOLT-REULEN periostotomo	270	MEYERDING separador para hemilaminectomia	148	osteotomo SMITH-PETERSEN	197
LANGENBECK periostotomo	209	MEYERDING-MARKHAM separador para hemilaminectomia	148	osteotomo STILLE	196
LANGENBECK separador	104-105	MICHELE trepano	182		
LANGENBECK-KÖCHER separador	104	micro clip vascular	312	P	
LAZAR micro pinza	63	micro clip vascular ACLAND	315-317	PAPAVERO-CASPAR especulo para hipofisectomia	264
legra	206-220, 225-226, 256, 265, 270	micro cucharilla YASARGIL	193, 256	PAPAVERO-HARTMANN pinza para especulo	264
legra de aspiracion	235	micro cucharilla YASARGIL	193	PENFIELD disector	224
legra de aspiracion GUILLEN	235	micro cuchillo KOOS	248-249	perforador	160, 176, 322-326
legra LANDOLT-REULEN	270	micro cuchillo YASARGIL	248	perforador de mano BUNELL	325
legra NICOLA	265	micro disector CASPAR	227-228	perforador de mano HUDSON	324
legra RHOTON	256	micro disector YASARGIL	227	perforador de mano KIRSCHNER	325
legra YASARGIL	225-227	micro espejo HARDY	269	perforador de mano MOORE	323
LEKSELL (STILLE) pinza gubia	170	MICRO FRIEDMANN pinza gubia	162	perforador de mano RALK	326
LEMPERT cucharilla cortante	190	micro pinza	62-67, 272	perforador de mano HADEO	326
LEMPERT pinza gubia	164-165	micro pinza AUSTIN	64	perforador de mano STILLE	322
LEXER gubia	201	micro pinza DE BAKKEY	67	perforador de mano STILLE-SHERMAN	323
LEXER MINI gubia	201	micro pinza LAZAR	63	periostotomo FOMON	211
LEXER MINI osteotomo	201	micro pinza YASARGIL	75	periostotomo ALEXANDER	210
LEXER osteotomo	201	micro porta aguja BARRAQUER	96	periostotomo CUSHING	207, 208
LEXER tijera de diseccion	22	micro porta aguja CASTROVIEJO	97	periostotomo	206-220, 225-226, 256, 265, 270
LEYLA separador de sistema	276-280	micro porta aguja YASARGIL	98	periostotomo COBB	217
ligera-ultra pinza	65	micro porta agujas	96-100	periostotomo CUSHING (LITTLE-JOKER)	207
LITON pinza cortante para huesos	172	micro tijera BIEMER	44-45	periostotomo DOYEN	212-213
LITON-RUSKIN pinza cortante para huesos	173	micro tijera CASTROVIEJO	36	periostotomo FARABEUF	206
LITTLE-JOKER (CUSHING) periostotomo	207	micro tijera FAHLBUSCH	271	periostotomo FARABEUF-COLLIN	206-207
Llave	10, 312, 325-326	micro tijera JACOBSON	44-45	periostotomo HOEN	209
LOVE separador para nervios	113-114	micro tijera MILLESI	44-45	periostotomo JANSEN	206
LOVE-GRUENWALD pinza para laminectomia	238	micro tijera NAGEL	43	periostotomo JOSEPH	211
LUCAE pinza	74	micro tijera NICOLA	271	periostotomo KÖNIG	210
LUER pinza gubia	163	micro tijera POTTS-YASARGIL	44-45	periostotomo LAMBOTTE	207
LUER-STILLE pinza gubia	169	micro tijera VANNAS	37, 42, 44-45	periostotomo LANDOLT-REULEN	270
		micro tijera YASARGIL	41-42, 44-45	periostotomo LANGENBECK	209
		micro tijeras	35-46, 271-272	periostotomo MATSON	214
M		MILLESI micro tijera	44-45	periostotomo MATSON-ALEXANDER	214
mango con chuck	117	MILLIGAN disector	222	periostotomo MOLT	210
mango de aspiracion	234	MILLS tijera vascular	29	periostotomo NICOLA	265
mango de bisturi	14-16, 117	MINI FRIEDMANN pinza gubia	162	periostotomo RHOTON	256
mango de bisturi CASPAR	16	MINI LEXER gubia	201	periostotomo SEDILLOT	207-208
mango de bisturi LANDOLT	16	MINI LEXER osteotomo	201	periostotomo SELDIN	211
mango para sierra GIGLI	177	MINI pinza aplicadora	305	periostotomo WAGNER	217
mango para sierra GIGLI STRULLY	177	MINI-LAMBOTTE osteotomo	199	periostotomo WILLIGER	210
mango para sierra HADEO	177	MISKIMON separador para cerebello	128	periostotomo YASARGIL	225-227
MARKHAM-MEYERDING separador para hemilaminectomia	148	MIXTER BABY pinza hemostatica	90	PETERSEN-SMITH gubia	197
MARQUARDT pinza gubia	168	MOLLISON separador	122	PETERSEN-SMITH osteotomo	197
MARTEL De guia-conductora	177	MOLT periostotomo	210	PETERSEN-SMITH pinza gubia	166
MARTEL pinza pericraneal	87	MOORE perforador de mano	323	pieza alargadera	324
MARTEL WILLET pinza pericraneal	87	MOSQUITO-HALSTED pinza hemostatica	84	pinza ADSON-BABY	88
martillo	8-10	MÜLLER aproximador	309	pinza aplicadora	83, 174, 176, 302-305, 318-320
martillo COTTLE	10	MÜLLER clip para vasos	310	pinza aplicadora ACLAND	318
martillo de percusion BABINSKY	8	MÜLLER-BIEMER aproximador	308	pinza aplicadora BIEMER	306, 308-309, 311
martillo de percusion BERLINER	8			pinza aplicadora McKENZIE	174
martillo de percusion BUCK	8	N		pinza aplicadora MEHDORN	307
martillo de percusion DEJERINE	8	NAGEL micro tijera	43	pinza aplicadora MINI	305
martillo de percusion TAYLOR - USA MOD	8	NEIVERT porta aguja	94	pinza aplicadora OLIVECRONA-TOENNIS	174
martillo de percusion TROEMNER	8	NICOLA cureta	265	pinza aplicadora RANEY	176
martillo OMBREDANNE	10	NICOLA legra	265	pinza aplicadora SMITHWICK	174
martillo WAGNER	10	NICOLA micro tijera	271	pinza aplicadora STANDARD	305
martillo WILLIGER	9	NICOLA periostotomo	265	pinza aplicadora SWEET	174
MATSON periostotomo	214	NICOLA pinza	271	pinza bipolar	328-334
MATSON-ALEXANDER periostotomo	214	NICOLA-YASARGIL pinza	271	pinza bipolar non-stick	332-333
MAYFIELD pinza gubia	167	non-stick pinza bipolar	332-333	pinza CITELLI	288
MAYO pinza de diseccion	58	NORFOLK/NORWICH separador	124	pinza cortante para huesos	172-173
MAYO tijera de diseccion	22	NORWICH/NORFOLK separador	124	pinza cortante para huesos BÖHLER	172
MAYO-ADAMS separador	124			pinza cortante para huesos COTTLE-KAZANJIAN	172



Indice Español

**HADEO**  
INSTRUMENTE GERMANY

pinza cortante para huesos LISTON.....	172	pinza micro YASARGIL.....	75	REULEN-LANDOLT cueta.....	270
pinza cortante para huesos MC INDOE.....	172	pinza NICOLA.....	271	REULEN-LANDOLT disector.....	270
pinza cortante para huesos RUSKIN-LISTON.....	173	pinza para cambiar hojas.....	144, 156	REULEN-LANDOLT gancho.....	270
pinza cortante para huesos SEMB.....	173	pinza para espejulo LANDOLT.....	263	REULEN-LANDOLT legra.....	270
pinza cortante para huesos STAMM.....	172	pinza para espejulo PAPAVERO-HARTMANN.....	264	REULEN-LANDOLT periostotomo.....	270
pinza cortante para huesos STILLE-HORSLEY.....	173	pinza para hipofisis ADSON.....	261	REYNOLDS tijera de diseccion.....	26
pinza COTTLE.....	74	pinza para joyero.....	61	RHOTON aguja.....	256
pinza de aspiracion bipolar.....	334	pinza para laminectomia.....	238-244	RHOTON disector.....	256
pinza DE BAKEY.....	68-69	pinza para laminectomia CASPAR.....	242-243	RHOTON gancho.....	256
pinza de diseccion ADLERKREUTZ.....	54	pinza para laminectomia CLOWARD.....	239	RHOTON legra.....	256
pinza de diseccion ADSON.....	51-52	pinza para laminectomia CUSHING.....	238	RHOTON periostotomo.....	256
pinza de diseccion ADSON-BROWN.....	52	pinza para laminectomia FERRIS-SMITH.....	241	RHOTON sonda.....	256
pinza de diseccion ADSON-DE BAKEY.....	51	pinza para laminectomia HOEN.....	240	RICHTER-SCOVILLE separador para laminectomia.....	138
pinza de diseccion BROPHY.....	54	pinza para laminectomia LANDOLT.....	245	riel para grapas.....	174
pinza de diseccion BROWN.....	53	pinza para laminectomia LOVE-GRUENWALD.....	238	ROGER elevador.....	220
pinza de diseccion CUSHING.....	53	pinza para laminectomia OLDBERG.....	245	rompe-hojas.....	17
pinza de diseccion CUSHING-TAYLOR.....	57	pinza para laminectomia SCHLESINGER.....	239	rompe-hojas CASTROVIEJO.....	17
pinza de diseccion DUEHRSEN.....	55	pinza para laminectomia SPURLING.....	238	rompe-hojas HADEO.....	17
pinza de diseccion GERALD.....	56-57	pinza para laminectomia WAGNER.....	241	rompe-hojas TROUTMAN-CHRIS.....	17
pinza de diseccion GILLIES.....	56	pinza para laminectomia WEIL-BLAKESLEY.....	244	RUSKIN pinza gubia.....	168
pinza de diseccion MAYO.....	58	pinza para laminectomia YASARGIL.....	245	RUSKIN-LISTON pinza cortante para huesos.....	173
pinza de diseccion McINDOE.....	55	pinza para proteccion de orificio.....	180	RUSKIN-STILLE pinza gubia.....	169
pinza de diseccion POTTS-SMITH.....	50	pinza para tejido y tumores HEIFETZ.....	72	RYDER porta aguja.....	95
pinza de diseccion SEMKEN.....	56	pinza para tejido y tumores HUNT.....	70-71		
pinza de diseccion TAYLOR.....	58	pinza para tejido y tumores SAMII.....	73	S	
pinza de diseccion WANGENSTEEN.....	58	pinza para tejido y tumores YASARGIL.....	70, 72	SACHS disector.....	221
pinza de diseccion WAUGH.....	53	pinza para tejido y tumores YASARGIL-SAMII.....	72	SACHS gancho.....	210
pinza de rejolejo.....	60-61	pinza para tendones CAROLL.....	92	SAMII cuchillo para tumores.....	251-252
pinza de succion bipolar.....	334	pinza para tumores TOENNIS.....	91	SAMII pinza para tumores y tejido.....	73
pinza de traccion craneal CRUTCHFIELD.....	176	pinza para tumores y tejido HEIFETZ.....	72	SAUERBRUCH costotomo.....	48
pinza en forma de cuchara.....	271-272	pinza para tumores y tejido HUNT.....	70-71	SAUERBRUCH pinza gubia.....	170
pinza FUCHSIG.....	88	pinza para tumores y tejido SAMII.....	73	SAUERBRUCH-FREY costotomo.....	48
pinza GEMINI.....	89	pinza para tumores y tejido YASARGIL.....	70, 72	SCALP-CONTOUR separador para el cuero cabelludo.....	127
pinza gubia.....	162-171	pinza para tumores y tejido YASARGIL-SAMII.....	72	SCHLESINGER pinza paralaminectomia.....	239
pinza gubia ADSON.....	163	pinza pericraneal MARTEL.....	87	SCHMIEDEN-TAYLOR tijera para duramadre.....	34
pinza gubia BACON.....	166	pinza pericraneal WILLET MARTEL.....	87	SCHUHKNECHT tubo de aspiracion.....	231
pinza gubia BANE-HARTMANN.....	164	pinza sacabocado craneal.....	178-179	SCOVILLE cucharilla cortante.....	187
pinza gubia BEYER.....	165, 167	pinza sacabocado craneal CONE.....	179	SCOVILLE gancho.....	137
pinza gubia BÖHLER.....	167	pinza sacabocado craneal DeVILLIBISS.....	178	SCOVILLE hoja.....	137
pinza gubia ECHLIN.....	171	pinza sacabocado para discos intervertebrales.....	282-286	SCOVILLE pinza-espátula.....	59
pinza gubia FRIEDMANN.....	162	pinza sacabocado para discos intervertebrales COLCLOUGH.....	286	SCOVILLE separador para laminectomia.....	137
pinza gubia FRIEDMANN MINI.....	162	pinza sacabocado para discos intervertebrales FERRIS-SMITH-KERRISON.....	282-285	SCOVILLE separador para nervios.....	111, 114
pinza gubia FRYKHOLM.....	171	pinza YASARGIL-NICOLA.....	271	SCOVILLE-HAVERFIELD separador para laminectomia.....	137
pinza gubia JANSEN.....	164	pinza-espátula SCOVILLE.....	59	SCOVILLE-RICHTER separador para laminectomia.....	138
pinza gubia KLEINERKUTZ.....	165	pinzas.....	50-92	SEBILEAU elevador.....	208
pinza gubia LEKSELL (STILLE).....	170	pinza-ultra ligera.....	65	SEDLLOT periostotomo.....	207-208
pinza gubia LEMPERS.....	164-165	PLESTER separador.....	122, 124	SELDIN periostotomo.....	211
pinza gubia LUER.....	163	PLESTER tubo de aspiracion.....	233	SEMB pinza cortante para huesos.....	173
pinza gubia MARQUARDT.....	168	porta aguja BAUMGARTNER.....	94	SEMB pinza gubia.....	171
pinza gubia MAYFIELD.....	167	porta aguja CRILE-WOOD.....	94	SEMKEN pinza de diseccion.....	56
pinza gubia MICRO FRIEDMANN.....	162	porta aguja DE BAKEY.....	95	sensimetro WARTENBERG.....	11
pinza gubia OLIVECRONA.....	164	porta aguja HALSEY.....	94	separador ADSON.....	125-126
pinza gubia RUSKIN.....	168	porta aguja MAYO-HEGAR.....	95	separador ALM.....	120
pinza gubia SAUERBRUCH.....	170	porta aguja micro BARRAQUER.....	96	separador BECKMANN-ADSON (CONE).....	126
pinza gubia SEMB.....	171	porta aguja micro CASTROVIEJO.....	97	separador cervical CASPAR.....	144
pinza gubia SMITH-PETERSEN.....	166	porta aguja micro YASARGIL.....	98	separador cervical CLOWARD.....	140-143
pinza gubia STELLBRINK.....	162	porta aguja NEIVERT.....	94	separador CUSHING.....	103
pinza gubia STILLE-LUER.....	169	porta aguja RYDER.....	95	separador de hoja CLOWARD.....	103
pinza gubia STILLE-RUSKIN.....	169	porta agujas.....	94-100	separador de sistema LEYLA.....	276-280
pinza gubia ZAUFAL-JANSEN.....	167	porta agujas micro.....	96-100	separador espinal TAYLOR.....	107
pinza guia taladros y protectora de duramadre ADSON.....	181	POTTS-DE MARTEL tijera vascular.....	29	separador GELPI.....	150
pinza HAJEK-KOFLER.....	287-288	POTTS-SMITH pinza de diseccion.....	50	separador HENLEY.....	123
pinza hemostatica CRILE.....	85	POTTS-SMITH tijera vascular.....	30-31	separador HOLZHEIM.....	120
pinza hemostatica CRILE-RANKIN.....	85	POTTS-YASARGIL micro tijera.....	44-45	separador JANSEN.....	120
pinza hemostatica DANDY.....	86	protectora de duramadre y pinza guia taladros ADSON.....	181	separador KOCHER.....	105
pinza hemostatica HALSTED-MOSQUITO.....	84			separador KOCHER-LANGENBECK.....	104
pinza hemostatica HARTMANN.....	83			separador lumbar CASPAR.....	154-156
pinza hemostatica JACOBSON.....	84			separador MAYO-ADAMS.....	124
pinza hemostatica KELLY.....	85	Q		separador MEYERDING.....	106
pinza hemostatica KELLY-RANKIN.....	85	QUERVAIN elevador.....	208	separador MOLLISON.....	122
pinza hemostatica MIXTER BABY.....	90			separador NORFOLK/NORWICH.....	124
pinza JANSEN.....	74	R		separador para cerebelo ANDERSON ADSON.....	128
pinza JANSEN-GRUENWALD.....	74	RALK perforador de mano.....	326	separador para cerebelo MISKIMON.....	128
pinza KERRISON.....	287	RANEY pinza aplicadora.....	176	separador para el cuero cabelludo SCALP-CONTOUR.....	127
pinza LANDOLT.....	264	RANKIN-CRILE pinza hemostatica.....	85	separador para hemilaminectomia DARLING.....	147
pinza LUCAE.....	74	RANKIN-KELLY pinza hemostatica.....	85	separador para hemilaminectomia MARKHAM-MEYERDING.....	148
pinza micro.....	62-67, 272	HADEO cucharilla cortante.....	190-191	separador para hemilaminectomia MEYERDING.....	148
pinza micro AUSTIN.....	64	HADEO mango para sierra.....	177	separador para hemilaminectomia WILLIAMS.....	149
pinza micro DE BAKEY.....	67	HADEO perforador de mano.....	326	separador para laminectomia ADSON.....	129
pinza micro LAZAR.....	63	HADEO rompe-hojas.....	17	separador para laminectomia BADGLEY.....	139
		regla.....	11		



separador para laminectomia BECKMANN .....	132	tijera de diseccion BABY-METZENBAUM BLACK .....	25	W	
separador para laminectomia BECKMANN-ADSON (CONE) .....	130	tijera de diseccion BLACK .....	25	WAGNER martillo .....	10
separador para laminectomia BECKMANN-EATON .....	132	tijera de diseccion JAMESON WERBER .....	26	WAGNER periostotomo .....	217
separador para laminectomia CASPAR .....	136	tijera de diseccion KILNER .....	26	WAGNER pinza para laminectomia .....	241
separador para laminectomia HARVEY-JACKSON .....	133	tijera de diseccion LEXER .....	22	WALTON separador para laminectomia .....	135
separador para laminectomia KNIGHTON .....	134	tijera de diseccion MAYO .....	22	WANGENSTEIN pinza dediseccion .....	58
separador para laminectomia SCOVILLE .....	137	tijera de diseccion MAYO-STILLE .....	22	WARTENBERG sensimetro .....	11
separador para laminectomia SCOVILLE-HAVERFIELD .....	137	tijera de diseccion METZENBAUM .....	23	WATSON-CHEYNE elevador .....	219
separador para laminectomia SCOVILLE-RICHTER .....	138	tijera de diseccion METZENBAUM BLACK .....	24-25	WAUGH pinza de diseccion .....	53
separador para laminectomia WALTON .....	135	tijera de diseccion METZENBAUM FINO .....	23	WEIL-BLAKESLEY pinza paralaminectomia .....	244
separador para nervios CASPAR .....	112	tijera de diseccion para nervios .....	27	WEITLANER separador .....	121
separador para nervios D'ERRICO .....	113	tijera de diseccion REYNOLDS .....	26	WEITLANER-WULLSTEIN separador .....	121
separador para nervios HESS .....	111	tijera de diseccion TOENNIS-ADSON .....	27	WERBER JAMESON tijera dediseccion .....	26
separador para nervios HOLSHER .....	111	tijera GRADLE .....	28	WILLET MARTEL pinzapericraneos .....	87
separador para nervios LOVE .....	113-114	tijera IRIS .....	27	WILLIAMS separador para hemilaminectomia .....	149
separador para nervios SCOVILLE .....	111, 114	tijera micro BIEMER .....	44-45	WILLIGER martillo .....	9
separador para vasos BIEMER .....	250	tijera micro CASTROVIEJO .....	36	WILLIGER periostotomo .....	210
separador para vertebrales CLOWARD .....	151, 153	tijera micro FAHLBUSCH .....	271	WOOD-CRILE porta aguja .....	94
separador para vertebrales INGE .....	152	tijera micro JACOBSON .....	44-45	WOODSON disector .....	223
separador PLESTER .....	122, 124	tijera micro MILLESI .....	44-45	WULLSTEIN separador .....	122
separador TRAVERS .....	125	tijera micro NAGEL .....	43	WULLSTEIN tubo de aspiracion .....	234
separador WEITLANER .....	121	tijera micro NICOLA .....	271	WULLSTEIN-WEITLANER separador .....	121
separador WEITLANER-WULLSTEIN .....	121	tijera micro VANNAS .....	37, 42, 44-45		
separador WULLSTEIN .....	122	tijera micro YASARGIL .....	41-42, 44-45	Y	
separadores .....	103-107, 111-114, 120-157	tijera para alambre UNIVERSAL .....	34	YASARGIL clips para aneurisma .....	290-301
separador LANGENBECK .....	104-105	tijera para cirugia DEEVER .....	21	YASARGIL gancho para galea .....	114
serra-fina DIEFFENBACH .....	83	tijera para cirugia KELLY .....	21	YASARGIL guaiador .....	116
serra-fina JOHNS-HOPKINS .....	83	tijera para cirugia STANDARD .....	20	YASARGIL horquilla para tumores .....	257
SET .....	338-343	tijera para duramadre SCHMIEDEN-TAYLOR .....	34	YASARGIL legra .....	225-227
SEWALL elevador .....	219	tijera para neurocirugia STRULLY .....	33	YASARGIL micro cucharilla .....	193
SHERMAN-STILLE perforador a mano .....	323	tijera para trigemino DANDY .....	33	YASARGIL micro cuchillo .....	248
sierra OLIVECRONA .....	177	tijera para trigemino OLIVECRONA .....	33	YASARGIL micro disector .....	227
sistema de distraccion vertebral .....	158-160	tijera para tumores .....	47	YASARGIL micro pinza .....	75
sistema de distraccion vertebral CASPAR .....	158	tijera STEVENS .....	28	YASARGIL micro porta aguja .....	98
SMITH-FERRIS pinza paralaminectomia .....	241	tijera vascular DE BAKEY .....	30-32	YASARGIL micro tijera .....	41-42, 44-45
SMITH-PETERSEN gubia .....	197	tijera vascular DIETRICH .....	29-30	YASARGIL periostotomo .....	225-227
SMITH-PETERSEN osteotomo .....	197	tijera vascular FAVALORO .....	32	YASARGIL pinza paralaminectomia .....	245
SMITH-PETERSEN pinza gubia .....	166	tijera vascular MILLS .....	29	YASARGIL pinza para tumores y tejido .....	70, 72
SMITH-POTTS pinza de diseccion .....	50	tijera vascular POTTS-DE MARTEL .....	29	YASARGIL tubo de aspiracion .....	232
SMITH-POTTS tijera vascular .....	30-31	tijera vascular POTTS-SMITH .....	30-31	YASARGIL-NICOLA pinza .....	271
SMITHWICK gancho .....	110	tijeras .....	20-47	YASARGIL-OKONEY horquilla para tumores .....	254
SMITHWICK pinza aplicadora .....	174	tijeras micro .....	35-46, 271-272	YASARGIL-POTTS microtijera .....	44-45
sonda .....	24 9, 256	TOENNIS disector .....	221	YASARGIL-SAMMI pinza para tumores y tejido .....	72
sonda JACOBSON .....	249	TOENNIS pinza para tumores .....	91		
sonda RHOTON .....	256	TOENNIS-ADSON tijera de diseccion .....	27	Z	
SPINAL cucharilla cortante .....	186-187	TOENNIS-OLIVECRONA pinza aplicadora .....	174	ZAUFAL-JANSEN pinza gubia .....	167
SPRATT cucharilla cortante .....	184	tomillos de distraccion .....	160	ZIELKE gubia .....	202
SPURLING pinza para laminectomia .....	238	TRAVERS separador .....	125	ZÖLLNER tubo de aspiracion .....	232
STAMM pinza cortante para huesos .....	172	trepano .....	181-182		
STANDARD pinza aplicadora .....	305	trepano craneal GALT .....	181		
STANDARD tijera para cirugia .....	20	trepano MICHELE .....	182		
STELLBRINK pinza gubia .....	162	TROEMNER martillo de percusion .....	8		
STEVENS tijera .....	28	TROUTMAN-CHRIS rompe-hojas .....	17		
STILLE (LEKSELL) pinzagubia .....	170	tubo de aspiracion .....	230-234		
STILLE cincel .....	196	tubo de aspiracion ADSON .....	230		
STILLE gubia .....	196	tubo de aspiracion BARON .....	231		
STILLE osteotomo .....	196	tubo de aspiracion FERGUSON .....	230		
STILLE perforador de mano .....	322	tubo de aspiracion FRAZIER/FERGUSON .....	231		
STILLE-GIERTZ costotomo .....	48	tubo de aspiracion HOUSE .....	233		
STILLE-HORSLEY pinza cortante para huesos .....	173	tubo de aspiracion PLESTER .....	233		
STILLE-LUER pinza gubia .....	169	tubo de aspiracion SCHUHKNECHT .....	231		
STILLE-MAYO tijera de diseccion .....	22	tubo de aspiracion WULLSTEIN .....	234		
STILLE-RUSKIN pinza gubia .....	169	tubo de aspiracion YASARGIL .....	232		
STILLE-SHERMAN perforador de mano .....	323	tubo de aspiracion ZÖLLNER .....	232		
STRULLY GIGLI mango para sierra .....	177	tubo de puncion FRAZIER/FERGUSON .....	231		
STRULLY tijera para neurocirugia .....	33	tubo de succion .....	230-234		
SWEET pinza aplicadora .....	174				
T		U			
taladro .....	160, 176, 322-324	ultra-ligera pinza .....	65		
taladro CUSHING .....	324	UNIVERSAL tijera para alambre .....	34		
taladro ERRICO .....	324	USA MOD - TAYLOR martillo de percusion .....	8		
taladro MC KENZIE .....	324				
tapas de repuesto para martillo .....	9-10	V			
TAYLOR - USA MOD martillo de percusion .....	8	VANNAS micro tijera .....	37, 42, 44-45		
TAYLOR hoja .....	137	VOLKMANN cucharilla cortante .....	184, 192		
TAYLOR pinza de diseccion .....	58				
TAYLOR separador espinal .....	107				
TAYLOR-CUSHING pinza de diseccion .....	57				
TAYLOR-SCHMIEDEN tijera para duramadre .....	34				

## Indice Italiano

**HADEO**  
 INSTRUMENTE GERMANY

<b>A</b>		<b>C</b>		curette JANSEN.....	192
AACHEN spatole cerebrali .....	274	cacciavite.....	160	curette LANDOLT.....	267
ACLAND approssimatore .....	315-317	calibro.....	11	curette LANDOLT-REULEN.....	270
ACLAND micro clips vascolari .....	315-317	cannula micro d'aspirazione.....	234	curette LEMPERT.....	190
ACLAND pinze applicatrice.....	318	cannula per punzione FRAZIER/FERGUSSON.....	231	curette micro.....	193
ADAMS-MAYO divaricatore.....	124	canula per manico di aspirazione.....	232	curette micro YASARGIL.....	193
adattator per aspirazione HOUSE.....	231	CAROLL pinze da presa per tendini.....	92	curette NICOLA.....	265
ADLERKREUTZ pinze per dissezione.....	54	CASPAR divaricatore.....	136, 144, 154-156, 158	curette per ipofisi HARDY.....	268
ADSON ANDERSON divaricatore.....	128	CASPAR manico per lame bisturi.....	16	curette HADEO.....	190-191
ADSON BABY pinze.....	88	CASPAR micro dissettore.....	228	curette RHOTON.....	256
ADSON divaricatore.....	125-126, 129	CASPAR pinze per laminectomia.....	242-243	curette SCOVILLE.....	187
ADSON elevatore.....	218	CASPAR pistoni.....	195	curette SPINAL.....	186-187
ADSON pinze guida-perforatore e proteggi dura-madre.....	181	CASPAR sonda conduttrice a forchetta.....	253	curette SPRATT.....	184, 192
ADSON pinze per dissezione.....	51-52	CASPAR sostegno osseo e impattatore.....	194	curette VOLKMANN.....	184, 194
ADSON pinze per ipofisi.....	261	CASPAR uncino.....	112, 115	CUSHING (LITTLE-JOKER) periototomo.....	207
ADSON pinze sgorbie.....	163	CASPAR-PAPAVERO specoli per ipofisectomia.....	264	CUSHING divaricatore.....	103
ADSON tubo aspirazione.....	230	CASTROVIEJO microforbici.....	36	CUSHING periototomo.....	208
ADSON uncino.....	110	CASTROVIEJO micro porta aghi.....	97	CUSHING pinze per dissezione.....	53
ADSON-BECKMANN (CONE) divaricatore.....	126, 130	CASTROVIEJO rompiplama.....	17	CUSHING pinze per laminectomia.....	238
ADSON-BROWN pinze per dissezione.....	52	cavi bipolare.....	335	CUSHING spatole cerebrali.....	274
ADSON-TOENNIS forbici.....	27	cesoie per ossa.....	172-173	CUSHING trapano.....	324
ago RHOTON.....	256	cesoie per ossa BÖHLER.....	172	CUSHING uncino.....	109
ALEXANDER periototomo.....	210	cesoie per ossa COTTLE-KAZANJIAN.....	172	CUSHING-LANDOLT specoli per ipofisectomia.....	263
ALEXANDER-MATSON periototomo.....	214	cesoie per ossa LISTON.....	172	CUSHING-TAYLOR pinze per dissezione.....	57
algesimetro WARTENBERG.....	11	cesoie per ossa MC INDOE.....	172		
ALM divaricatore.....	120	cesoie per ossa RUSKIN-LISTON.....	172	<b>D</b>	
ANDERSON ADSON divaricatore.....	128	cesoie per ossa SEMB.....	173	DANDY forbici per trigemino.....	33
approssimatore ACLAND.....	315-317	cesoie per ossa STAMM.....	172	DANDY pinze emostatiche.....	86
approssimatore BIEMER.....	312	cesoie per ossa STILLE-HORSLEY.....	173	DANDY uncino.....	108
arco per trazione craniale CRUTCHFIELD.....	176	cesoie per ossa STILLE-LISTON.....	173	DARLING divaricatore.....	147
AUSTIN micro pinze.....	64	CHEYNE-WATSON elevatore.....	219	DAUBENSPECK curette.....	189
		chiave.....	10, 136, 312, 325-326	DAVIS dissettore per dura-madre.....	221-222
<b>B</b>		CITELLI pinze-punzoni.....	288	DAVIS spatole cerebrali.....	275
BABINSKY martelli da percussione.....	8	clips micro vascolari BIEMER.....	312	DE BAKEY forbici vascolari.....	30-32
BABY ADSON pinze.....	88	clips micro vascolari ACLAND.....	315-317	DE BAKEY micro pinze.....	67
BABY MIXTER pinze.....	90	clips per aneurisma YASARGIL.....	290-301	DE BAKEY pinze.....	68-69
BABY-METZENBAUM-BLACK forbici per dissezione.....	25	clips per vasi.....	306-310	DE BAKEY pinze bulldog.....	80-82
BACON pinze sgorbie.....	166	clips per vasi BIEMER.....	306, 308-309, 311	DE BAKEY porta aghi.....	95
BADGLEY divaricatore.....	139	clips per vasi MEHDORN.....	311	DE BAKEYDIETHRICH pinze bulldog.....	78
BANE-HARTMANN pinze sgorbie.....	164	clips per vasi MÜLLER.....	307	DE BAKEYHESS pinze bulldog.....	82
BARON tubo aspirazione.....	231	CLOWARD divaricatore.....	103, 140-143, 151, 153	DE MARTEL-POTT'S forbici vascolari.....	29
BARRAQUER micro porta aghi.....	96	CLOWARD pinze per laminectomia.....	239	DEAVER forbici per chirurgia.....	21
battenti di ricambio.....	9-10	coagulazione bipolare.....	328-333	DEJERINE martelli da percussione.....	8
BAUMGARTNER porta aghi.....	94	COBB curette.....	185	delicate forbici.....	27-28
BECKMANN divaricatore.....	132	COBB elevatore.....	217	DeMARTEL strumenti introduttori.....	177
BECKMANN-ADSON (CONE) divaricatore.....	126, 130	COBB sgorbia.....	200	D'ERRICO uncino.....	113
BECKMANN-EATON divaricatore.....	132	COLCLOUGH pinze taglienti per dischi intervertebrali.....	286	DeVILBISS pinza per craniotomia.....	178
BERLINER martelli da percussione.....	8	COLLIN-FARABEUF periototomo.....	206-207	diapason.....	11
BEYER pinze sgorbie.....	165, 167	coltello micro per vasi KOOS.....	248-249	DIEFFENBACH pinze serrafina.....	83
BIEMER approssimatore.....	312	coltello micro per vasi YASARGIL.....	248	DIETHRICH pinze bulldog.....	78
BIEMER clips per vasi.....	306, 308-309, 311	coltello per tumore SAMII.....	251-252	DIETHRICH-DE BAKEY pinzebulldog.....	78
BIEMER divaricatore per vasi.....	250	conduttori per legature KRAYENBÜHL.....	116	DIETRICH forbici vascolari.....	29-30
BIEMER micro forbici.....	44-45	CONE curette.....	260	dilatatori vascolari.....	61, 250
BIEMER pinze applicatrice.....	306, 308-309, 311	CONE pinza per craniotomia.....	179	dissettore.....	211, 221-224, 256, 266, 270
bipolare cavi.....	335	container per conservazione e sterilizzazione.....	313-314	dissettore GORNEY.....	211
bipolare pinze.....	328-333	CONTOUR-SCALP divaricatore.....	127	dissettore HARDY-FAHLBUSCH.....	266
bipolare pinze con canale di aspirazione.....	334	costotomi.....	48	dissettore LANDOLT-REULEN.....	270
bipolare pinze non-stick.....	332-333	costotomi GIERTZ-STILLE.....	48	dissettore micro.....	227-228
bisturi.....	15	costotomi SAUERBRUCH.....	48	dissettore micro YASARGIL.....	227
BLACK forbici per dissezione.....	25	costotomi SAUERBRUCH-FREY.....	48	dissettore PENFIELD.....	224
BLACK METZENBAUM forbici per dissezione.....	24-25	COTTLE martelli.....	10	dissettore per dura-madre DAVIS.....	221-222
BLAKESLEY-WEIL pinze per laminectomia.....	244	COTTLE osetotomo.....	204	dissettore per dura-madre e FRAZIER.....	223
BÖHLER cesoie per ossa.....	172	COTTLE pinze.....	74	dissettore per dura-madre e HOEN.....	223
BÖHLER pinze sgorbie.....	167	COTTLE-KAZANJIAN cesoie per ossa.....	172	dissettore per dura-madre e HORSLEY.....	222
BOIES sgorbia.....	211	CRILE pinze emostatiche.....	85	dissettore per dura-madre e MILLIGAN.....	222
BROPHY pinze per dissezione.....	54	CRILE uncino.....	109	dissettore per dura-madre e OLIVECRONA.....	221
BROWN pinze per dissezione.....	53	CRILE-RANKIN pinze emostatiche.....	85	dissettore per dura-madre e SACHS.....	221
BROWN-ADSON pinze per dissezione.....	52	CRILE-WOOD porta aghi.....	94	dissettore per dura-madre e TOENNIS.....	221
BRUNS curette.....	188	CRUTCHFIELD arco per trazione craniale.....	176	dissettore per dura-madre e WOODSON.....	223
BUCK martelli da percussione.....	8	cucchiaio FAHLBUSCH.....	270	dissettore RHOTON.....	256
bulldog pinze.....	78-82	cucchiaio HARDY.....	269	divaricatore.....	103-107, 120-144
bulldog pinze DE BAKEY.....	80-82	cucchiaio LANDOLT.....	267	divaricatore ADSON.....	125-126, 129
bulldog pinze DIETHRICH.....	78	curette.....	184-193, 256, 260, 262, 265, 267-268, 270	divaricatore ALM.....	120
bulldog pinze GLOVER.....	81	curette BRUNS.....	188	divaricatore ANDERSON ADSON.....	128
BUNELL perforatore a mano.....	325	curette BUSHE.....	191	divaricatore BADGLEY.....	139
BUSHE curette.....	191	curette COBB.....	185	divaricatore BECKMANN.....	132
		curette CONE.....	260	divaricatore BECKMANN-ADSON (CONE).....	126, 130
		curette DAUBENSPECK.....	189	divaricatore BECKMANN-EATON.....	132
		curette FAHLBUSCH.....	270	divaricatore CASPAR.....	136, 144, 154-156, 158
		curette HALLE.....	186	divaricatore CLOWARD.....	103, 140-143, 151, 153



divaricatore CUSHING.....	103	forbici micro CASTROVIEJO.....	36	H	
divaricatore DARLING.....	147	forbici micro FAHLBUSCH.....	271	HAEK-KOFLER pinze-punzoni.....	287-288
divaricatore GELPI.....	150	forbici micro JACOBSON.....	44-45	HALLE curette.....	186
divaricatore HARVEY-JACKSON.....	133	forbici micro M ILLESI.....	44-45	HALSEY porta aghi.....	94
divaricatore HENLEY.....	123	forbici micro NAGEL.....	43	HALSTED-MOSQUITO pinze emostatiche.....	84
divaricatore HOLZHEIMER.....	120	forbici micro NICOLA.....	271	HARDY cucchiaio.....	269
divaricatore JANSEN.....	120	forbici micro VANNAS.....	36, 42, 44-45	HARDY curette per ipofisi.....	268
divaricatore KNIGHTON.....	134	forbici micro YASARGIL.....	41-42, 44	HARDY enucleatore.....	266
divaricatore KOCHER.....	105	forbici per chirurgia STANDARD.....	20	HARDY forchetta per trapianti.....	266
divaricatore KOCHER-LANGENBECK.....	104	forbici per chirurgia DEEVER.....	21	HARDY micro specchio.....	269
divaricatore LANGENBECK.....	104-105	forbici per chirurgia KELLY.....	21	HARDY-FAHLBUSCH dissettore.....	266
divaricatore MARKHAM-MEYERDING.....	148	forbici per dissezione BABY-METZENBAUM-BLACK.....	25	HARTMANN pinze emostatiche.....	83
divaricatore MAYO-ADAMS.....	124	forbici per dissezione BLACK.....	25	HARTMANN-BANE pinze sgorbie.....	164
divaricatore MEYERDING.....	106, 148	forbici per dissezione JAMESON WERBER.....	26	HARTMANN-PAPAVERO pinze per specoli.....	264
divaricatore MISKIMON.....	128	forbici per dissezione KILNER.....	26	HARVEY-JACKSON divaricatore.....	133
divaricatore MOLLISON.....	122	forbici per dissezione LEXER.....	22	HAVERFIELD-SCOVILLE divaricatore.....	137
divaricatore NORFOLK/NORWICH.....	124	forbici per dissezione MAYO.....	22	HEGAR-MAYOR porta aghi.....	95
divaricatore per vasi BIEMER.....	250	forbici per dissezione MAYO-STILLE.....	22	HEIFETZ pinze per afferrare tumori e tessuti.....	72
divaricatore PLESTER.....	122, 124	forbici per dissezione METZENBAUM.....	23	HEIFETZ spatole ceebrali.....	275
divaricatore SCALP-CONTOUR.....	127	forbici per dissezione METZENBAUM BLACK.....	24-25	HENLEY divaricatore.....	123
divaricatore SCOVILLE.....	137	forbici per dissezione METZENBAUM FINO.....	23	HESS uncino.....	111
divaricatore SCOVILLE-HAVERFIELD.....	137	forbici per dissezione REYNOLDS.....	26	HESS-DE BAKEY pinze bulldog.....	82
divaricatore SCOVILLE-RICHTER.....	138	forbici per dura-madre SCHMIEDEN-TAYLOR.....	34	HOEN dissettore per dura-madre.....	223
divaricatore TAYLOR.....	107	forbici per filo di metallo e lamiera UNIVERSAL.....	34	HOEN periostotomo.....	209
divaricatore TRAVERS.....	125	forbici per lamiera e filo di metallo UNIVERSAL.....	34	HOEN pinze per laminectomia.....	240
divaricatore WALTON.....	135	forbici per neurochirurgia STRULLY.....	33	HOLSHER uncino.....	111
divaricatore WEITLANER.....	121	forbici per trigemino DANDY.....	33	HOLZHEIMER divaricatore.....	120
divaricatore WEITLANER-WULLSTEIN.....	121	forbici per trigemino OLIVECRONA.....	33	HOPKINS-JOHNS pinze serrafina.....	83
divaricatore WILLIAMS.....	149	forbici per tumori.....	47	HORSLEY dissettore per dura-madre.....	222
divaricatore WULLSTEIN.....	122	forbici STEVENS.....	28	HORSLEY-STILLE cesoie per ossa.....	173
DONALD MC elevatore.....	219	forbici TOENNIS-ADSON.....	27	HOSOBUCHI spatola.....	267
DOYEN periostotomo.....	212-213	forbici vascolari DE BAKEY.....	30-32	HOUSE adattatore per aspirazione.....	231
DUEHRSEN pinze per dissezione.....	55	forbici vascolari DIETRICH.....	29-30	HOUSE tubo aspirazione.....	233
		forbici vascolari FAVALORO.....	32	HUDSON perforatore a mano.....	324
E		forbici vascolari POTTS-DE MARTEL.....	29	HUNT pinze per afferrare tumori e tessuti.....	70-71
EATON-BECKMANN divaricatore.....	132	forbici vascolari POTTS-SMITH.....	30-31		
ECHLIN pinze sgorbie.....	171	forchetta per trapianti HARDY.....	266	I	
elevatore.....	208, 213, 217-220	forchetta per tumore OKONEK-YASARGIL.....	254	impattatore e sostegno osseo CASPAR.....	194
elevatore ADSON.....	218	forchetta per tumore YASARGIL.....	257	INDOE MC cesoie per ossa.....	172
elevatore COBB.....	217	FRAZIER dissettore per dura-madre.....	223	INGE separatore.....	152
elevatore FREER.....	220	FRAZIER uncini per pelle.....	102	IRIS forbici.....	27
elevatore JOSEPH.....	219	FRAZIER/FERGUSON cannula per punzione.....	231		
elevatore KEY.....	218	FRAZIER/FERGUSON tubo aspirazione.....	231	J	
elevatore MC DONALD.....	219	FREER elevatore.....	220	JACKSON-HARVEY divaricatore.....	133
elevatore ROGER.....	220	FREER uncini per pelle.....	102	JACOBSON micro forbici.....	44-45
elevatore SEWALL.....	219	FREY-SAUERBRUCH costotomi.....	48	JACOBSON micro uncinetti.....	118
elevatore WATSON-CHEYNE.....	219	FRIEDMANN MICRO pinze sgorbie.....	162	JACOBSON sonda.....	249
elevatori QUERVAIN.....	208	FRIEDMANN MINI pinze sgorbie.....	162	JACOBSON sonda conduttrice a forchetta.....	253
elevatori SEBILEAU.....	208	FRIEDMANN pinze sgorbie.....	162	JAMESON WERBER forbici per dissezione.....	26
enucleatore HARDY.....	266	FRYKHOLM pinze sgorbie.....	171	JANSEN curette.....	192
enucleatore LANDOLT.....	267	FUCHSIG pinze.....	88	JANSEN divaricatore.....	120
ERRICO trapano.....	324			JANSEN periostotomo.....	206
		G		JANSEN pinze.....	74
F		GALT trapano.....	181	JANSEN pinze sgorbie.....	164
FAHLBUSCH cucchiaio.....	270	GELPI divaricatore.....	150	JANSEN-GRUENWALD pinze.....	74
FAHLBUSCH curette.....	270	GEMINI pinze.....	89	JANSEN-ZAUFAL pinze sgorbie.....	167
FAHLBUSCH micro forbici.....	271	GERALD pinze per dissezione.....	56-57	JOHNS-HOPKINS pinze serrafina.....	83
FAHLBUSCH-HARDY dissettore.....	266	GIERTZ-STILLE costotomi.....	48	JOSEPH elevatore.....	219
FARABEUF periostotomo.....	206	GIGLI manico per sega.....	177	JOSEPH periostotomo.....	211
FARABEUF-COLLIN periostotomo.....	206-207	GIGLI STRULLY manico per sega.....	177	JOSEPH uncini per pelle.....	102
FAVALORO forbici vascolari.....	32	GILLIES pinze per dissezione.....	56		
femaglio.....	176	GILLIES uncini per pelle.....	102	K	
femaglio RANEY.....	176	giunti di prolungamento.....	324	KAZANJIAN-COTTLE cesoie per ossa.....	172
FERGUSON tubo aspirazione.....	230	GLOVER pinze bulldog.....	81	KELLY forbici per chirurgia.....	21
FERGUSON/FRAZIER cannula per punzione.....	231	GORNEY dissettore.....	211	KELLY pinze emostatiche.....	85
FERGUSON/FRAZIER tubo aspirazione.....	231	GRADLE forbici.....	28	KELLY-RANKIN pinze emostatiche.....	85
FERRIS-SMITH pinze per laminectomia.....	241	GRAHAM uncino.....	110	KENZIE MC trapano.....	324
FERRIS-SMITH-KERRISON pinze taglianti per dischi intervertebrali.....	282-285	GRUENWALD-JANSEN pinze.....	74	KERRISON pinze-punzoni.....	287
FINO METZENBAUM forbici per dissezione.....	23	GRUENWALD-LOVE pinze per laminectomia.....	238	KEY elevatore.....	218
FISCH micro uncinetti.....	118	guida telescopica.....	325	KILNER forbici per dissezione.....	26
FISCH uncino.....	249	GUILLEN raspatario con aspiratore.....	235	KIRSCHNER perforatore a mano.....	325
FISCH uncino per dura madre.....	249			KLEINERT-KUTZ pinze sgorbie.....	165
FOMON periostotomo.....	211			KNIGHTON divaricatore.....	134
forbici.....	20-47			KOCHER divaricatore.....	105
forbici delicate.....	27-28			KOCHER-LANGENBECK divaricatore.....	104
forbici GRADLE.....	28			KOFLER-HAEK pinze-punzoni.....	287-288
forbici IRIS.....	27			KÖNIG periostotomo.....	210
forbici micro.....	35-46, 271-272			KOOS micro coltello per vasi.....	248-249
forbici micro BIEMER.....	44-45			KRAYENBUHL conduttori per legature.....	116
				KUTZ-KLEINERT pinze sgorbie.....	165

## Indice Italiano

**HADEO**  
 INSTRUMENTE GERMANY

L		METZENBAUM BLACK forbici per dissezione .....	24-25	O	
LAMBOTTE osteotomo .....	198	METZENBAUM FINO forbici per dissezione .....	23	OKONEK-YASARGIL forchetta per tumore .....	254
LAMBOTTE periostotomo .....	207	METZENBAUM forbici per dissezione .....	23	OLDBERG pinze per laminectomia .....	245
LAMBOTTE-MINI osteotomo .....	199	MEYERDING divaricatore .....	106, 148	OLIVECRONA dissettore per dura-madre .....	221
LANDOLT cucchiaio .....	267	MEYERDING-MARKHAM divaricatore .....	148	OLIVECRONA forbici per trigemino .....	33
LANDOLT curette .....	267	MICHELE trapano .....	182	OLIVECRONA pinza sgorbie .....	164
LANDOLT enucleatore .....	267	micro cannula d'aspirazione .....	234	OLIVECRONA sega .....	177
LANDOLT manico per lame bisturi .....	16	micro clips vascolari BIEMER .....	312	OLIVECRONA spatole cerebrali .....	274
LANDOLT pinze .....	264	micro clips vascolari ACLAND .....	315-317	OLIVECRONA-TOENNIS pinze per applicae .....	174
LANDOLT pinze per laminectomia .....	245	micro coltello per vasi KOOS .....	248-249	OMBREDANNE martelli .....	10
LANDOLT pinze per specoli .....	263	micro coltello per vasi YASARGIL .....	248	osteotomo .....	196-199, 204
LANDOLT uncino .....	267	micro curette .....	193	osteotomo COTTLE .....	204
LANDOLT-CUSHING specoli per ipofisectomia .....	263	micro curette YASARGIL .....	193	osteotomo LAMBOTTE .....	198
LANDOLT-REULEN curette .....	270	micro dissettore e .....	227-228	osteotomo LEXER .....	201
LANDOLT-REULEN dissettore .....	270	micro dissettore CASPAR .....	228	osteotomo LEXER MINI .....	201
LANDOLT-REULEN raspatore .....	270	micro dissettore YASARGIL .....	227	osteotomo MINI-LAMBOTTE .....	199
LANDOLT-REULEN uncino .....	270	micro forbici .....	35-46, 271-272	osteotomo SMITH-PETERSEN .....	197
LANGENBECK divaricatore .....	104-105	micro forbici BIEMER .....	44-45	osteotomo STILLE .....	196
LANGENBECK periostotomo .....	209	micro forbici CASTROVIEJO .....	36		
LANGENBECK-KOCHER divaricatore .....	104	micro forbici FAHLBUSCH .....	271	P	
LAZAR micro pinze .....	63	micro forbici JACOBSON .....	44-45	PAPAVERO-CASPAR specoli per ipofisectomia .....	264
leggera-ultra-pinze .....	65	micro forbici MILLESI .....	44-45	PAPAVERO-HARTMANN pinze per specoli .....	264
LEKSELL (STILLE) pinze sgorbie .....	170	micro forbici NAGEL .....	43	PENFIELD dissettore .....	224
LEMPERT curette .....	190	micro forbici NICOLA .....	271	perforatore .....	160, 176
LEMPERT pinze sgorbie .....	164-165	micro forbici POTTS-YASARGIL .....	44-45	perforatore a mano BUNELL .....	325
LEXER forbici per dissezione .....	22	micro forbici VANNAS .....	36, 42, 44-45	perforatore a mano HUDSON .....	324
LEXER MINI osteotomo .....	201	micro forbici YASARGIL .....	41-42, 44	perforatore a mano KIRSCHNER .....	325
LEXER MINI sgorbia .....	201	MICRO FRIEDMANN pinze sgorbie .....	162	perforatore a mano MOORE .....	323
LEXER osteotomo .....	201	micro periostotomo .....	225-226	perforatore a mano RALK .....	326
LEXER sgorbia .....	201	micro periostotomo YASARGIL .....	225-226	perforatore a mano HADEO .....	326
LEYLA sistema di fissaggio .....	276-280	micro pinze .....	62-64, 66-67, 75, 271-272	perforatore a mano STILLE .....	322
LISTON cesoie per ossa .....	172	micro pinze AUSTIN .....	64	perforatore a mano STILLE-SHERMANN .....	323
LISTON-RUSKIN cesoie per ossa .....	172	micro pinze DE BAKEY .....	67	periostotomo .....	206-217, 256, 265, 270
LISTON-STILLE cesoie per ossa .....	173	micro pinze LAZAR .....	63	periostotomo ALEXANDER .....	210
LITTLE-JOKER (CUSHING) periostotomo .....	207	micro pinze YASARGIL .....	75	periostotomo CUSHING .....	208
LOVE uncino .....	113-114	micro porta aghi .....	96-100	periostotomo CUSHING (LITTLE-JOKER) .....	207
LOVE-GRUENWALD pinze per laminectomia .....	238	micro porta aghi BARRAQUER .....	96	periostotomo DOYEN .....	212-213
LUCAE pinze .....	74	micro porta aghi CASTROVIEJO .....	97	periostotomo FARABEUF .....	206
LUER pinze sgorbie .....	163	micro porta aghi YASARGIL .....	98	periostotomo FARABEUF-COLLIN .....	206-207
LUER-STILLE pinze sgorbie .....	169	micro specchio HARDY .....	269	periostotomo FOMON .....	211
		micro uncinetti FISCH .....	118	periostotomo HOEN .....	209
M		micro uncinetti JACOBSON .....	118	periostotomo JANSEN .....	206
manico con mandrino .....	117	MILLESI micro forbici .....	44-45	periostotomo JOSEPH .....	211
manico d'aspirazione .....	234	MILLIGAN dissettore per dura-madre .....	222	periostotomo KÖNIG .....	210
manico per lame bisturi .....	14-16, 117	MINI FRIEDMANN pinze sgorbie .....	162	periostotomo LAMBOTTE .....	207
manico per lame bisturi CASPAR .....	16	MINI LEXER osteotomo .....	201	periostotomo LANGENBECK .....	209
manico per lame bisturi LANDOLT .....	16	MINI LEXER sgorbia .....	201	periostotomo MATSON .....	214
manico per sega GIGLI .....	177	MINI posa clips .....	302-305	periostotomo MATSON-ALEXANDER .....	214
manico per sega GIGLI STRULLY .....	177	MINI-LAMBOTTE osteotomo .....	199	periostotomo micro .....	225-226
manico per sega HADEO .....	177	MISKIMON divaricatore .....	128	periostotomo micro YASARGIL .....	225-226
MARKHAM-MEYERDING divaricatore .....	148	MIXTER BABY pinze .....	90	periostotomo MOLT .....	210
MARQUARDT pinze sgorbie .....	168	MOLLISON divaricatore .....	122	periostotomo RHOTON .....	256
MARTEL pinze per cuoio capelluto .....	87	MOLT periostotomo .....	210	periostotomo SEDILLOT .....	207
MARTEL WILLET pinze per cuoio capelluto .....	8-10	MOORE perforatore a mano .....	323	periostotomo SEDILLOT .....	208
martelli .....	8-10	MOSQUITO-HALSTED pinze emostatiche .....	84	periostotomo SELDIN .....	211
martelli COTTLE .....	10	MÜLLER clips per vasi .....	310	periostotomo WAGNER .....	217
martelli da percussione BABINSKY .....	8			periostotomo WILLIGER .....	210
martelli da percussione BERLINER .....	8	N		PETERSEN-SMITH osteotomo .....	197
martelli da percussione BUCK .....	8	NAGEL micro forbici .....	43	PETERSEN-SMITH pinze sgorbie .....	166
martelli da percussione DEJERINE .....	8	NEIVERT porta aghi .....	94	PETERSEN-SMITH sgorbia .....	197
martelli da percussione TAYLOR - USA Mod. .....	8	NICOLA curette .....	265	pinza LANDOLT .....	264
martelli da percussione TROEMNER .....	8	NICOLA micro forbici .....	271	pinza per craniotomia CONE .....	179
martelli OMBREDANNE .....	10	NICOLA pinze .....	271	pinza per craniotomia DeVILBISS .....	178
martelli WAGNER .....	10	NICOLA raspatore .....	265	pinza per la protezione del foro .....	180
martelli WILLIGER .....	9	NICOLA-YASARGIL pinze da presa .....	271	pinza per laminectomia LANDOLT .....	245
MATSON periostotomo .....	214	non-stick pinze bipolar e .....	332-333	pinze .....	50-92
MATSON-ALEXANDER periostotomo .....	214	NORFOLK/NORWICH divaricatore .....	124	pinze a spatola SCOVILLE .....	59
MAYFIELD pinze sgorbie .....	167	NORWICH/NORFOLK divaricatore .....	124	pinze ADSON BABY .....	88
MAYO forbici per dissezione .....	22			pinze applicatrice .....	83, 174, 176, 302-309, 311, 318-320
MAYO pinze per dissezione .....	58			pinze applicatrice ACLAND .....	318
MAYO-ADAMS divaricatore .....	124			pinze applicatrice BIEMER .....	306, 308-309, 311
MAYO-HEGAR porta aghi .....	95			pinze applicatrice MEHDORN .....	307
MAYO-STILLE forbici per dissezione .....	22			pinze applicatrice RANEY .....	176
MC DONALD elevatore .....	219			pinze bipolare .....	328-333
MC INDOE cesoie per ossa .....	172			pinze bipolare con canale di aspirazione .....	334
MC KENZIE trapano .....	324			pinze bipolare non-stick .....	332-333
McINDOE pinze per dissezione .....	55			pinze bulldog .....	78-82
McKENZIE pinze per applicare .....	174			pinze bulldog DE BAKEY .....	80-82
MEHDORN clips per vasi .....	307			pinze bulldog DE BAKEY-DIETHRICH .....	78
MEHDORN pinze applicatrice .....	307			pinze bulldog DE BAKEY-HESS .....	82

pinze bulldog DIETRICH .....	78	pinze serrafina DIEFFENBACH.....	83	REULEN-LANDOLT raspatore .....	270
pinze bulldog GLOVER.....	81	pinze serrafina JOHNS-HOPKINS .....	83	REULEN-LANDOLT uncino .....	270
pinze COTTLE.....	74	pinze sgorbie .....	162-171	REYNOLDS forcipi per dissezione.....	26
pinze da orologio .....	60-61	pinze sgorbie ADSON.....	163	RHOTON ago .....	256
pinze da presa per tendini CAROLL .....	92	pinze sgorbie BACON.....	166	RHOTON curette .....	256
pinze da presa YASARGIL-NICOLA .....	271	pinze sgorbie BANE-HARTMANN .....	164	RHOTON dissettore .....	256
pinze DE BAKEY .....	68-69	pinze sgorbie BEYER.....	165, 167	RHOTON periostotomo .....	256
pinze emostatiche CRILE .....	85	pinze sgorbie BÖHLER .....	167	RHOTON sonda .....	256
pinze emostatiche CRILE-RANKIN.....	85	pinze sgorbie ECHLIN .....	171	RHOTON uncino.....	256
pinze emostatiche DANDY .....	86	pinze sgorbie FRIEDMANN .....	162	RICHTER-SCOVILLE divaricatore .....	138
pinze emostatiche HALSTED-MOSQUITO.....	84	pinze sgorbie FRIEDMANN MINI.....	162	ROGER elevatore.....	220
pinze emostatiche HARTMANN.....	83	pinze sgorbie FRYKHOLM .....	171	rompi lama .....	17
pinze emostatiche KELLY .....	85	pinze sgorbie JANSEN .....	164	rompi lama CASTROVIEJO.....	17
pinze emostatiche KELLY-RANKIN.....	85	pinze sgorbie KLEINERTKUTZ .....	165	rompi lama HADEO.....	17
pinze FUCHSIG .....	88	pinze sgorbie LEKSELL (STILLE).....	170	rompi lama TROUTMAN-CHRIS.....	17
pinze GEMINI.....	89	pinze sgorbie LEMPERT .....	164-165	RUSKIN pinze sgorbie .....	168
pinze guida-perforatore e proteggi dura-madre ADSON .....	181	pinze sgorbie LUER .....	163	RUSKIN-LISTON cesoie per ossa .....	172
pinze JANSEN .....	74	pinze sgorbie MARQUARDT.....	168	RUSKIN-STILLE pinze sgorbie.....	169
pinze JANSEN-GRUENWALD.....	74	pinze sgorbie MAYFIELD .....	167	RYDER porta aghi.....	95
pinze LUCAE .....	74	pinze sgorbie MICRO FRIEDMANN.....	162		
pinze micro .....	62-64, 66-67, 75, 271-272	pinze sgorbie OLIVECRONA.....	164	S	
pinze micro AUSTIN .....	64	pinze sgorbie RUSKIN .....	168	SACHS dissettore per dura-madre .....	221
pinze micro DE BAKEY .....	67	pinze sgorbie SAUERBRUCH .....	170	SACHS uncino .....	110
pinze micro LAZAR .....	63	pinze sgorbie SEMB .....	171	SAMII coltello per tumore.....	251-252
pinze micro YASARGIL .....	75	pinze sgorbie SMITH-PETERSEN.....	166	SAMII pinze per afferrare tumori e tessuti .....	73
pinze MIXTER BABY.....	90	pinze sgorbie STELLBRINK .....	162	SAMII-YASARGIL pinze per afferrare tumori e tessuti .....	72
pinze NICOLA.....	271	pinze sgorbie STILLE-LUER.....	169	SAUERBRUCH costotomi .....	48
pinze per afferrare tessuti e tumori HUNT.....	70-71	pinze sgorbie STILLE-RUSKIN.....	169	SAUERBRUCH pinze sgorbie .....	170
pinze per afferrare tessuti e tumori .....	70-73	pinze sgorbie ZAUFAL-JANSEN.....	167	SAUERBRUCH-FREY costotomi.....	48
pinze per afferrare tessuti e tumori HEIFETZ.....	72	pinze taglienti per dischi intervertebrali COLCLOUGH .....	286	SCALP-CONTOUR divaricatore .....	127
pinze per afferrare tessuti e tumori SAMII .....	73	pinze taglienti per dischi intervertebrali .....		scalpello .....	196
pinze per afferrare tessuti e tumori YASARGIL .....	70, 72	FERRIS-SMITH-KERRISON .....	282-285	scalpello STILLE .....	196
pinze per afferrare tessuti e tumori YASARGIL-SAMII.....	72	pinze TOENNIS.....	91	SCHLESINGER pinze per laminectomia .....	239
pinze per afferrare tumori e tessuti.....	70-73	pinze-punzoni CITELLI .....	288	SCHMIEDEN-TAYLOR forcipi per dura-madre .....	34
pinze per afferrare tumori e tessuti HEIFETZ.....	72	pinze-punzoni HAJEK-KOFLER .....	287-288	SCHUHNECHT tubo aspirazione .....	231
pinze per afferrare tumori e tessuti HUNT.....	70-71	pinze-punzoni KERRISON .....	287	SCOVILLE curette.....	187
pinze per afferrare tumori e tessuti SAMII .....	73	pinze-ultra-leggera.....	65	SCOVILLE divaricatore .....	137
pinze per afferrare tumori e tessuti YASARGIL .....	70, 72	pistoni .....	195	SCOVILLE pinza a spatola .....	59
pinze per applicare McKENZIE.....	174	pistoni CASPAR .....	195	SCOVILLE uncino .....	111, 114, 137
pinze per applicare OLIVECRONA-TOENNIS.....	174	PLESTER divaricatore.....	122, 124	SCOVILLE valve.....	137
pinze per applicare SMITHWICK .....	174	PLESTER tubo aspirazione .....	233	SCOVILLE-HAVERFIELD divaricatore .....	137
pinze per applicare SWEET .....	174	porta aghi .....	94-100	SCOVILLE-RICHTER divaricatore .....	138
pinze per cambiare valve .....	144, 156	porta aghi BAUMGARTNER .....	94	SEBILEAU elevatori .....	208
pinze per cuoio capelluto MARTEL .....	87	porta aghi CRILE-WOOD.....	94	SEDILLOT periostotomo .....	207
pinze per cuoio capelluto WILLET MARTEL.....	87	porta aghi DE BAKEY .....	95	SEDILLOT periostotomo .....	208
pinze per dissezione ADLERKREUTZ.....	54	porta aghi HALSEY .....	94	sega OLIVECRONA .....	177
pinze per dissezione ADSON .....	51-52	porta aghi MAYO-HEGAR .....	95	SELDIN periostotomo .....	211
pinze per dissezione ADSON-BROWN.....	52	porta aghi micro .....	96-100	SEMB cesoie per ossa .....	173
pinze per dissezione BROPHY .....	54	porta aghi micro BARRAQUER.....	96	SEMB pinze sgorbie .....	171
pinze per dissezione BROWN .....	53	porta aghi micro CASTROVIEJO .....	97	SEMKEN pinze per dissezione .....	56
pinze per dissezione CUSHING .....	53	porta aghi micro YASARGIL .....	98	separatoro INGE .....	152
pinze per dissezione CUSHING-TAYLOR.....	57	porta aghi NEIVERT .....	94	serrafina pinze DIEFFENBACH.....	83
pinze per dissezione DUEHRSEN.....	55	porta aghi RYDER.....	95	set.....	338-343
pinze per dissezione GERALD .....	56-57	porta-fermagli .....	174	SEWALL elevatore .....	219
pinze per dissezione GILLIES .....	56	posa clips MINI.....	302-305	sgorbia .....	196-197, 200-203, 211
pinze per dissezione MAYO .....	58	posa clips STANDARD .....	302-305	sgorbia BOIES .....	211
pinze per dissezione McINDOE.....	55	POTTS-DE MARTEL forcipi vascolari .....	29	sgorbia COBB .....	200
pinze per dissezione POTTS-SMITH .....	50	POTTS-SMITH forcipi vascolari .....	30-31	sgorbia LEXER .....	201
pinze per dissezione SEMKEN .....	56	POTTS-SMITH pinze per dissezione .....	50	sgorbia LEXER MINI .....	201
pinze per dissezione TAYLOR .....	58	POTTS-YASARGIL micro forcipi .....	44-45	sgorbia SMITH-PETERSEN.....	197
pinze per dissezione WANGENSTEEN.....	58			sgorbia STILLE .....	196
pinze per dissezione WAUGH .....	53	Q		sgorbia ZIELKE .....	202
pinze per gioielliere .....	61	QUERVAINElevatori .....	208	SHERMANN-STILLE perforatore a mano .....	323
pinze per ipofisi ADSON .....	261			sistema di distrazione vertebrale cervicale .....	159
pinze per laminectomia .....	238-244	R		sistema di fissaggio LEYLA .....	276-280
pinze per laminectomia CASPAR.....	242-243	RALK perforatore a mano .....	326	SMITH-FERRIS pinze per laminectomia .....	241
pinze per laminectomia CLOWARD .....	239	RANEY femaglio .....	176	SMITH-PETERSEN osteotomo .....	197
pinze per laminectomia CUSHING .....	238	RANEY pinze applicatrice.....	176	SMITH-PETERSEN pinze sgorbie .....	166
pinze per laminectomia FERRIS-SMITH.....	241	RANKIN-CRILE pinze emostatiche.....	85	SMITH-PETERSEN sgorbia.....	197
pinze per laminectomia HOEN .....	240	RANKIN-KELLY pinze emostatiche .....	85	SMITH-POTTS pinze per dissezione .....	50
pinze per laminectomia LOVE-GRUENWALD .....	238	raspatore LANDOLT-REULEN .....	270	SMITHWICK pinze per applicare .....	174
pinze per laminectomia OLDBERG .....	245	raspatore NICOLA .....	265	SMITHWICK uncino .....	110
pinze per laminectomia SCHLESINGER.....	239	raspatario con aspiratore GUILLEN.....	235	sonda conduttrice a forch etta CASPAR .....	253
pinze per laminectomia SPURLING .....	238	HADEO curette .....	190-191	sonda conduttrice a forchetta JACOBSON .....	253
pinze per laminectomia WAGNER .....	241	HADEO manico per sega .....	177	sonda JACOBSON .....	249
pinze per laminectomia WEIL-BLAKESLEY .....	244	HADEO perforatore a mano .....	326	sonda RHOTON .....	256
pinze per laminectomia YASARGIL .....	245	HADEO rompi lama .....	17	sostegno osseo e impattatore CASPAR .....	194
pinze per specoli LANDOLT .....	263	regolo .....	11	spatola HOSOBUCHI.....	267
pinze per specoli PAPAVERO-HARTMANN.....	264	REULEN-LANDOLT curette .....	270	spatole cerebrali AACHEN .....	274
pinze proteggi dura-madre e guida-perforatore ADSON .....	181	REULEN-LANDOLT dissettore.....	270	spatole cerebrali CUSHING .....	274



## Indice Italiano

**HADEO**  
 INSTRUMENTE GERMANY

spatole cerebrali DAVIS .....	275	uncino LOVE .....	113-114
spatole cerebrali HEIFETZ .....	275	uncino per dura madre FISCH .....	249
spatole cerebrali OLIVECRONA .....	274	uncino per pelle FRAZIER .....	102
specchio micro HARDY .....	269	uncino per pelle FREER .....	102
specoli per ipofisectomia CUSHING-LANDOLT .....	263	uncino per pelle GILLIES .....	102
specoli per ipofisectomia PAPAVERO-CASPAR .....	264	uncino per pelle JOSEPH .....	102
SPINAL curette .....	186-187	uncino per tessuto .....	255
SPRATT curette .....	184	uncino RHOTON .....	256
SPURLING pinze per laminectomia .....	238	uncino SACHS .....	110
STAMM cesoie per ossa .....	172	uncino SCOVILLE .....	111, 114, 137
STANDARD forbici per chirurgia .....	20	uncino SMITHWICK .....	110
STANDARD posa clips .....	302-305	UNIVERSAL forbici per filo di metallo e lamiera .....	34
STELLBRINK pinze sgorbie .....	162	USA Mod. - TAYLOR martelli da percussione .....	8
STEVENS forbici .....	28		
STILLE (LEKSELL) pinzesgorbie .....	170	V	
STILLE osteotomo .....	196	valve .....	136-138, 140-146, 154-157
STILLE perforatore a mano .....	322	valve SCOVILLE .....	137
STILLE scalpello .....	196	valve TAYLOR .....	137
STILLE sgorbia .....	196	VANNAS micro forbici .....	36, 42, 44-45
STILLE-GIERTZ costotomi .....	48	vite distrattore .....	160
STILLE-HORSLEY cesoie per ossa .....	173	VOLKMANN curette .....	184, 192
STILLE-LISTON cesoie per ossa .....	173		
STILLE-LUER pinze sgorbie .....	169	W	
STILLE-MAYO forbici per dissezione .....	22	WAGNER martelli .....	10
STILLE-RUSKIN pinze sgorbie .....	169	WAGNER periostotomo .....	217
STILLE-SHERMANN perforatore a mano .....	323	WAGNER pinze per laminectomia .....	241
STRULLY forbici per neurochirurgia .....	33	WALTON divaricatore .....	135
STRULLY GIGLI manico per sega .....	177	WANGENSTEEN pinze per dissezione .....	58
strumenti introduttori DeMAR TEL .....	177	WARTENBERG algesimetro .....	11
SWEET pinze per applicare .....	174	WATSON-CHEYNE elevatore .....	219
		WAUGH pinze per dissezione .....	53
T		WEIL-BLAKESLEY pinze per laminectomia .....	244
TAYLOR - USA Mod. martelli da percussione .....	8	WEITLANER divaricatore .....	121
TAYLOR divaricatore .....	107	WEITLANER-WULLSTEIN divaricatore .....	121
TAYLOR pinze per dissezione .....	58	WERBER JAMESON forbici per dissezione .....	26
TAYLOR valve .....	137	WILLET MARTEL pinze per cuoio capelluto .....	87
TAYLOR-CUSHING pinze per dissezione .....	57	WILLIAMS divaricatore .....	149
TAYLOR-SCHMIEDEN forbici per dura-madre .....	34	WILLIGER martelli .....	9
TOENNIS dissettore per dura-madre .....	221	WILLIGER periostotomo .....	210
TOENNIS pinze .....	91	WOOD-CRILE porta aghi .....	94
TOENNIS-ADSON forbici .....	27	WOODSON dissettore per dura-madre .....	223
TOENNIS-OLIVECRONA pinze per applicae .....	174	WULLSTEIN divaricatore .....	122
trapano .....	322-324	WULLSTEIN tubo aspirazione .....	234
trapano CUSHING .....	324	WULLSTEIN-WEITLANER divaricatore .....	121
trapano ERRICO .....	324		
trapano GALT .....	181	Y	
trapano MC KENZIE .....	324	YASARGIL clips per aneurisma .....	290-301
trapano MICHELE .....	182	YASARGIL forchetta per tumore .....	257
TRAVERS divaricatore .....	125	YASARGIL micro coltello per vasi .....	248
TROEMNER martelli da percussione .....	8	YASARGIL micro curette .....	193
TROUTMAN-CHRIS rompi lama .....	17	YASARGIL micro dissettore .....	227
tubo aspirazione .....	230-234	YASARGIL micro forbici .....	41-42, 44
tubo aspirazione ADSON .....	230	YASARGIL micro periostotomo .....	225-226
tubo aspirazione BARON .....	231	YASARGIL micro pinze .....	75
tubo aspirazione FERGUSSON .....	230	YASARGIL micro porta aghi .....	98
tubo aspirazione HOUSE .....	233	YASARGIL pinze per afferrare tumori e tessuti .....	70, 72
tubo aspirazione PLESTER .....	233	YASARGIL pinze per laminectomia .....	245
tubo aspirazione SCHUHKNECHT .....	231	YASARGIL tubo aspirazione .....	232
tubo aspirazione WULLSTEIN .....	234	YASARGIL-NICOLA pinze da presa .....	271
tubo aspirazione YASARGIL .....	232	YASARGIL-OKONEK forchetta per tumore .....	254
tubo aspirazione ZÖLLNER .....	232	YASARGIL-POTTS micro forbici .....	44-45
tubo aspirazione FRAZIER/FERGUSSON .....	231	YASARGIL-SAMII pinze per afferrare tumori e tessuti .....	72
U		Z	
ultra-leggera-pinze .....	65	ZAUFAL-JANSEN pinze sgorbie .....	167
uncinetti micro FISCH .....	118	ZIELKE sgorbia .....	202
uncinetti micro JACOBSON .....	118	ZÖLLNER tubo aspirazione .....	232
uncino .....	102, 108-118, 136, 249, 256, 270		
uncino ADSON .....	110		
uncino CASPAR .....	112, 115		
uncino CRILE .....	109		
uncino CUSHING .....	109		
uncino DANDY .....	108		
uncino D'ERRICO .....	113		
uncino FISCH .....	249		
uncino GRAHAM .....	110		
uncino HESS .....	111		
uncino HOLSHER .....	111		
uncino LANDOLT .....	267		
uncino LANDOLT-REULEN .....	270		





**HADEO**  
INSTRUMENTE GERMANY

