

HNO/SINUSKOPIE
ENT/SINUSCOPY
ORL/SINUSCOPIÁ

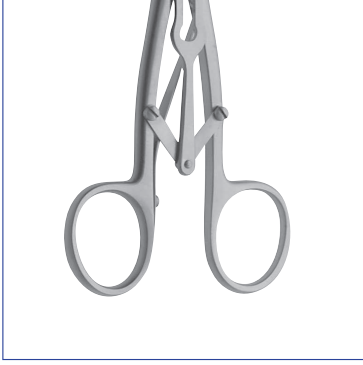

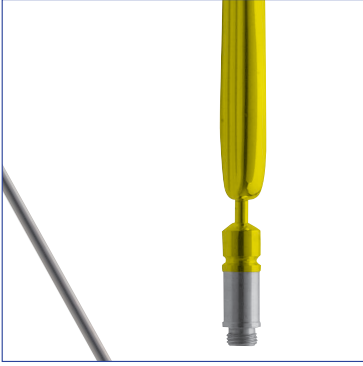



HADEO

INSTRUMENTE GERMANY



Charrière (Ch) French (F)	Durchmesser in mm	Inches	Gauge (G)	Durchmesser in mm	Inches
1	0,33	0,013	35	0,13	0,005
2	0,67	0,025	34	0,18	0,007
3	1,00	0,039	33	0,20	0,008
4	1,33	0,051	32	0,23	0,009
5	1,67	0,065	31	0,25	0,010
6	2,00	0,0787	30	0,30	0,012
7	2,33	0,092	29	0,33	0,013
8	2,67	0,105	28	0,36	0,014
9	3,00	0,1181	27	0,41	0,016
10	3,33	0,131	26	0,46	0,018
11	3,67	0,144	25	0,51	0,020
12	4,00	0,1575		0,53	0,021
13	4,33	0,170	24	0,56	0,022
14	4,67	0,184	23	0,64	0,025
15	5,00	0,1968	22	0,71	0,028
16	5,33	0,210	21	0,81	0,032
17	5,67	0,223	20	0,89	0,035
18	6,00	0,2362	19	0,97	0,038
19	6,33	0,249	18	1,07	0,042
20	6,67	0,263	17	1,27	0,050
21	7,00	0,2756	16	1,50	0,059
22	7,33	0,288	15	1,65	0,065
23	7,67	0,302	14	1,83	0,072
24	8,00	0,3150	13	2,11	0,083
25	8,33	0,328	12	2,41	0,095
26	8,67	0,341	11	2,77	0,109
27	9,00	0,3543	10	3,05	0,120
28	9,33	0,367	9	3,40	0,134
29	9,67	0,380	8	3,76	0,148
30	10,00	0,3973	7	4,19	0,165
31	10,33	0,407	6	4,57	0,180
32	10,67	0,420		5,16	0,203
34	11,33	0,446			
36	12,00	0,4724			
38	12,67	0,494			
40	13,33	0,5199			
45	15,00	0,5905			

1 OZ	0,028 ml
5 OZ	0,140 ml
16 OZ	0,450 ml

35 OZ	1,0 l
128 OZ	3,7 l

GARANTIE / WARRANTY / GARANTIA / GARANZIA

GARANTIE

Wir gewähren auf alle Hadeo Instrumente 3 Jahre Garantie. Voraussetzung ist der sach- und fachgerechte Einsatz der Instrumente.

Von der Garantie sind Verschleißerscheinungen ausgeschlossen.

WARRANTY

Our Hadeo products are free from manufacturing defects in material and workmanship. We therefore give on all instruments a guarantee of 3 years provided that the instruments are maintained and cleaned properly and used normally for their intended purpose.

GARANTIA

Estamos convencidos de nuestra calidad y concedemos a todos los instrumentos de Hadeo 3 años de garantía contra cualquier defecto de fabricación, siempre y cuando se usen adecuadamente. De la garantía excluimos la manifestación de desgaste.

GARANZIA

Siamo convinti della nostra qualità e concediamo 3 anni di garanzia sulla funzione dei tutti gli strumenti Hadeo sotto la presupposizione che l'utilizzo è da esperto.

Escluso della garanzia sono tracce di consumo.

Arbeitsanweisung Aufbereitung (Reinigung) und Sterilisation von resterilisierbaren chirurgischen Instrumenten

Hersteller:
Hadeo Instrumente

Alle von Hadeo gelieferten wieder verwendbaren Instrumente wurden ausschließlich für den chirurgischen Gebrauch konstruiert und dürfen zu keinen anderen Zwecken benutzt werden. Unsachgemäße Handhabung und sorglose Pflege sowie zweckentfremdeter Gebrauch können zu vorzeitigem Verschleiß der Instrumente führen. Die Produkte sind bei der Auslieferung nicht sterilisiert.

Reinigungsvorbereitung

Fabrikneue Instrumente müssen vor der ersten Anwendung den gesamten Aufbereitungsprozess durchlaufen. Instrumente unmittelbar nach Anlieferung aus den Folienverpackungen entnehmen und in trockenen Räumen bei gleichbleibender Raumtemperatur luftoffen lagern, um Kondensationsbildung zu vermeiden. Die Instrumente keinen Sonnenlichteinstrahlungen oder Dämpfen durch Chemikalien (Säuren oder scharfe Reinigern) aussetzen. Vor der ersten Sterilisation alle Schutzkappen und Folien vollständig entfernen und anschließend reinigen.

Gebrauchte Instrumente unmittelbar nach Beendigung des Eingriffs von Blut, Gewebe und Arzneimittel reinigen. Instrumente in eine freigegebene Lösung eines kombinierten Reinigungs- und Desinfektionsmittels, das keine proteinfixierende Wirkung besitzt, einlegen. Dosierung des Herstellers beachten. Nicht in NaCl Lösung einlegen, ansonsten Gefahr für Loch- bzw. Spannungsriss-Korrosion

Überfüllung von Instrumentensieben und Wasch-Trays vermeiden.

Gelenkinstrumente vor dem Aufbereiten öffnen. Zerlegbare Instrumente gemäß Bedienungsanleitung (Piktogramm) zur Reinigung zerlegen. Reinigungsgerechtes Zubehör verwenden. Für die manuelle Reinigung nie Metallbürsten oder Metallschwämme verwenden. Spülmaschinen und Ultraschallanlagen nicht überladen. Spül- oder Schallschatten vermeiden. Dosierung, Einwirkzeit und Einwirktemperatur bei der Desinfektion und Reinigung unbedingt einhalten. Nach der Reinigung sorgfältig spülen. Möglichst vollentsalztes (demineralisiertes) Wasser verwenden. Nach dem Spülen ausreichend trocknen. Abgenutzte, korrodierte, deformierte, poröse oder anderweitig beschädigte Instrumente aussortieren.

Aus hygienischen Gründen müssen Instrumente, die zur Reparatur eingesandt werden komplett aufbereitet werden. Gelenkinstrumente nach jeder Aufbereitung mit einem Pflegemittel auf Basis von Paraffinöl behandeln (gilt nicht für flexible Endoskope und Zubehör). Funktionsprüfung in zusammengebautem Zustand durchführen. Instrumente mit Rastensperre vor der Sterilisation nur im ersten Zahn schließen.

Als Sterilisationsverfahren empfehlen wir die Dampfsterilisation (üblicherweise mit Sattedampf bei 134° C)

Sterilisation ist kein Ersatz für Sauberkeit!

Die Broschüre "Instrumenten-Aufbereitung richtig gemacht" des Arbeitskreis Instrumenten-Aufbereitung dient als Anhalt.

Hadeo Instrumente

IMPORTANT INFORMATION CONCERNING PREPARING AND STERILIZING SURGICAL INSTRUMENTS

Dear Sirs,
please read the following instructions very carefully before using the instruments.

1. INITIAL USE

All instruments which are being used for the first time must be thoroughly cleaned, rinsed and then sterilized before using.

2. TREATING INSTRUMENTS AFTER USAGE

- a.) The instruments might be immediately thoroughly cleaned and disinfected. Please follow the manufacturer's instructions when using cleaning agents and disinfectants.
- b.) Instruments which may be dismantled must be cleaned and disinfected after being taken apart.
- c.) Cleaning may be carried out either manually or with a machine. Care should be taken that only cleaning agents and disinfectants are used, which are changed daily.
- d.) Following chemical disinfection and manual cleaning, all instruments must always be thoroughly rinsed under running water.
- e.) The temperature of water used in a machine for cleaning should not exceed 45°C.
- f.) Whether cleaning is carried out manually or by machine, we especially ask you to ensure that the correct dosage for cleaning solutions or the correct combination of disinfectant and cleaning solution, is employed. Similar importance should be applied to the length of time the agents require to perform properly and to the temperature set.
- g.) Hinged instruments should be opened before cleaning.
- h.) Please ensure that the perforated instrument trays, when loaded, do not exceed 10 kg in weight.
- i.) Please take care that when instruments are being cleaned they are arranged proper in a manne that fluids can circulate freely.
- j.) Deposits remaining after the cleaning process must be completely removed in the first rinse which now follows. The optimum temperature for final rinsing has proved to be between 70° and 90° C. Please use only purified water in this final cleaning stage.
- k.) The instruments must be carefully dried after cleaning and rinsing is completed.
- l.) Moving parts and the cutting edges of shears and scissors must be treated with preservatives which are both suitable and physiologically safe.

3. TESTING FOR CORRECT FUNCTIONING

- a.) Instruments must be carefully and thoroughly checked before every occasion that they are used.

- b.) After each time they are cleaned, the instruments must be macroscopically clean, i.e., visibly free from proteinbased residues and other soiling.
- c.) Care should be taken so that cracks, breakages and corrosion are noticed.
- d.) Instruments with flecks should be separated and taken out for special treatment.
- e.) All moving parts as well as working tips and blades should be checked with special care.
- f.) Checking should be carried out according to the extent to which the instruments will be used.
- g.) Instruments which are in any way defective or damaged should be immediately sorted out from the others.

4. STERILIZATION

- a.) All stainless steel surgical instruments supplied by us may be sterilized in an autoclave.
- b.) Please follow the manufacturer's operating instructions when using autoclave. All machines used must comply with all current quality and other standards.
- c.) Instruments are being sterilized/ autoclaved at a temperature of 134°C.
- d.) Sterilization packing material must comply with all current standards.
- e.) Instruments with ratchets or self-retaining mechanisms should be sterilized opened or in the first ratchet position.
- f.) Please ensure that perforated instrument trays, when loaded do not exceed 10 kg in weight.

5. IN GENERAL

- a.) All surgical instruments supplied by us have been thoroughly inspected before dispatch and leave our factory in perfect condition. Damage which can arise as a result of transporting, cleaning, preserving, sterilizing or storing, must be prevented.
- b.) Please handle surgical instruments always with the utmost care.
- c.) Instruments must be stored in a clean and dry place.
- d.) If you have any queries or problems please contact us at any time:

We should like to point out that, if the above-mentioned directions are not followed or the instruments supplied by us are not properly used, all guarantee claims become void and any consequences must be borne by yourselves.

SUGERENCIAS PARA LA LIMPIEZA, ESTERILIZACIÓN Y MANTENIMIENTO DE INSTRUMENTOS QUIRÚRGICOS

ENJUAGADO

Tras el uso enjuagar enseguida los instrumentos bajo un chorro de agua caliente (no hirviendo). El enjuagado debe servir para quitar los residuos de sangre, mucosas y tejidos.

LIMPIEZA

Si la limpieza no se efectúa inmediatamente después del enjuagado, los instrumentos tienen que sumergirse en una solución de agua y detergente con PH neutro (7)

Para los instrumentos muy delicados (algunos tipos de porta agujas o tijeras se aconseja una limpieza manual: ver punto "C").

a.- Limpieza en la pila de ultrasonido

Los instrumentos tienen que estar en la pila el tiempo necesario recomendado por el fabricante para efectuar el ciclo del lavado, generalmente de 5 a 10 minutos.

Los instrumentos con bisagras o juntas (articulaciones) tienen que sumergirse en la pileta en posición abierta.

Asegurarse de que las hojas afiladas de las tijeras, bisturíes para gingivectomía, curetas, etc. no estén en contacto con otros instrumentos.

Todos los instrumentos deben estar completamente sumergidos en la solución de lavado.

No poner instrumentos de diferentes metales (acero inoxidable, instrumentos cromados, latón, etc.) en el mismo ciclo de lavado.

Cambiar a menudo la solución para el lavado, como mínimo todas las veces que lo recomienda el fabricante de la pila de ultrasonidos.

Enjuagar concienzudamente los instrumentos con agua corriente tras lavado con ultrasonidos para quitar los residuos de la solución de lavado.

b.- Limpieza con lavadora

Seguir las indicaciones del fabricante. Asegurarse de que los instrumentos hayan sido lubricados tras el último ciclo de lavado y antes del ciclo de esterilización.

c.- Limpieza manual

La mayor parte de los fabricantes de instrumentos indican el lavado con los ultrasonidos como el modo mejor y más eficaz para limpiar los instrumentos quirúrgicos, especialmente los que tienen bisagras, cerrés y en general articulaciones. Si la limpieza con los ultrasonidos no es posible, se aconseja usar el método siguiente:

- Usar cepillos rígidos de plástico, nylon, etc.
- Cepillar concienzudamente los instrumentos más delicados y, si es posible, enjuagar, limpiar y esterilizar estos instrumentos separadamente.
- Verificar que toda la superficie de estos instrumentos esté limpia.
- Tras haber cepillado los instrumentos, enjuagarlos bajo el chorro de agua corriente.
- Durante el enjuagado abrir y cerrar las tijeras, las pinzas hemostáticas, los porta agujas y los demás instrumentos con bisagras o juntas y asegurarse de que las partes internas de las bisagras estén perfectamente enjuagadas como la superficie externa del instrumento.

SECADO, LUBRIFICACIÓN E INSPECCIÓN

Tras las operaciones de limpieza y de enjuagado, los instrumentos quirúrgicos tienen que ser secados perfectamente.

Todos los instrumentos con juntas o bisagras (acción "metal contra metal") como tijeras, pinzas hemostáticas, porta agujas, fórceps de extracción, etc., tienen que ser lubricados. Se aconsejan lubricantes específicos para el instrumental quirúrgico. No usar aceites o lubricantes industriales.

A este punto es buena norma inspeccionar el estado de cada instrumento y verificar el funcionamiento según el uso específico. Controlar y asegurarse de que:

- Las hojas de las tijeras estén lisas de arriba abajo y de que, una vez cerradas, no hagan juego. Probar las tijeras cortando gasa muy fina. Tres cuartas parte de la hoja tienen que cortar la gasa sin retenerla.

- Las puntas de las pinzas estén al mismo nivel.
- Las pinzas hemostáticas y los porta agujas no dejen pasar la luz entre las puntas cuando estén cerradas, se abran y cierren fácilmente y que las bisagras no estén demasiado flojas.
- Controlar el desgaste de la porta agujas sobre la superficie interna de las puntas.
- Las cánulas metálicas de aspiración estén bien limpias en su interior.
- Los instrumentos cortantes y los bisturíes tengan las hojas bien afiladas y no estropeadas.

ESTERILIZACIÓN EN AUTOCLAVE

Tras haber enjuagado, limpiado, secado, lubricado e inspeccionado los instrumentos, éstos pueden ser preparados para la esterilización separadamente o en serie.

Instrumentos individuales:

Las bolsas especiales monouso son el ideal para contener los instrumentos. Asegurarse de que las bolsas que contendrán los instrumentos con cerrés y articulaciones (pinzas hemostáticas, porta agujas, etc.) sean lo bastante grandes como para contener los citados instrumentos en posición abierta.

Instrumentos en serie:

Poner los instrumentos en los especiales cestos o bandejas de acero inoxidable. Poner los instrumentos más pesados en la parte inferior cuando sean necesarias varias bandejas.

No cerrar nunca los instrumentos durante el ciclo en autoclave. Un instrumento cerrado no estará nunca bien esterilizado, ya que el vapor no puede penetrar en la parte de cierre a contacto "metal contra metal". En el instrumento podría además romperse en la parte de la bisagra a causa de la expansión del metal debida al calor durante el ciclo del autoclave.

No cargar demasiado la cámara del autoclave ya que algunos instrumentos podrían formar "zonas de sombra" sobre otros en los que el vapor no penetraría.

ATENCIÓN

Al final del ciclo de esterilización - antes del ciclo de secado- abrir ligeramente la portezuela del autoclave y preceder con el ciclo desecado según las instrucciones del fabricante. Si la portezuela del autoclave se abre completamente antes del ciclo de secado, el aire frío de la habitación entraría en la cámara del autoclave causando la formación de condensación sobre los instrumentos y de consecuencia aparecerían las manchas de agua que vemos a menudo en los mismos.

ESTERILIZACIÓN EN FRÍO

La mayor parte de las soluciones para la esterilización en frío esterilizan los instrumentos completamente tras 10 horas de inmersión. Esta acción química prolongada puede ser más perjudicial para los instrumentos que el ciclo normal de 20 minutos en autoclave.

Si los instrumentos tienen necesidad de ser simplemente "desinfectados", el proceso en frío es adecuado, ya que la desinfección tiene lugar en 10 minutos solamente.

Recuerde bien la diferencia entre:

ESTÉRIL - término absoluto (ningún organismo logra sobrevivir) y

DESINFECTADO - perfectamente limpio.

Usen siempre la técnica más adecuada de esterilización/limpieza de los instrumentos según el uso que se haga posteriormente de ellos.

Recuerden que la esterilización de los instrumentos no sustituye la limpieza de los mismos.

Recomendamos no volver a usar ni esterilizar los artículos de un solo uso.

Si se tratan en el modo correcto los instrumentos construidos con las modernas aleaciones inoxidables pueden durar muchos años.



REINIGUNG, PFLEGE UND STERILISATION
CLEANING, CARE AND STERILIZATION
LIMPIEZA, MANTENIMIENTO Y ESTERILIZACION

ENDOSKOPE 13 - 20
ENDOSCOPES
ENDOSCOPIOS

STIRNLAMPEN 21 - 28
HEAD LIGHTS
LÁMPARAS FRONTALES

BOHRER 29 - 32
BURRS
BROCAS

HOCHFREQUENZ-CHIRURGIE 33 - 46
HIGH FREQUENCY SURGERY
CIRUGIA DE ALTA FRECUENCIA

OTOLOGIE UND OHR-MIKROCHIRURGIE 47 - 138
OTOLOGY AND EAR MICROSURGERY
OTOLOGÍA Y MICRO CIRUGIA PARA OIDO

RHINOLOGIE - SINUSKOPIE 139 - 266
RHINOLOGY - SINUSCOPY
RINOLOGÍA - SINUSCOPIA

ADENOTOMIE UND TONSILLEKTOMIE 267 - 312
ADENOTOMY AND TONSILLECTOMY
ADENOTOMÍA Y TONSILECTOMÍA

TRACHEOTOMIE	313 - 320
TRACHEOTOMY	
TRAQUEOTOMÍA	

LARYNGOSKOPIE UND ENDOLARYNGEAL E MIKROCHIRURGIE	321 - 354
LARYNGOLOGY AND ENDOLARYNGEAL MICROSURGERY	
LARINGOSCOPIA Y MICRO CIRUGIA ENDOLARINGEAL	

BRONCHOSKOPIE	355 - 356
BRONCHOSCOPY	
BRONCOSCOPIA	

INSTRUMENTENSÄTZE	357- 372
INSTRUMENT SETS	
JUEGOS DE INSTRUMENTOS	

NUMMERNVERZEICHNIS	373 - 384
NUMERICAL INDEX	
INDICE NUMERICO	

ALPHABETISCHER INDEX	385 - 419
ALPHABETICAL INDEX	
INDICE ALFABETICO	





ENDOSKOPE

ENDOSCOPES

ENDOSCOPIOS

HADEO
INSTRUMENTE GERMANY

Indikationen und Kontraindikationen finden Sie in der entsprechenden Gebrauchsanweisung!
Indication and Contraindication please refer to our user's manual!
Indicaciones y Contraindicaciones se encuentran en la instrucciones de uso correspondientes!

Ultra-slim Nasolaryngoskop
 Ultra-slim Nasolaryngoscope
 Nasolaryngoscopia Ultra-slim



R805-130402-034

300 mm Nutzlänge / working length / largo útil

3,4 mm Durchmesser / diameter / diametro

130° aufwärts / abwärts Schwenkbereich des distalen Endes
 up / down Bending range of distal tip
 hacia arriba / hacia abajo distal final girable

0° Blickwinkel / direction of view / direccion de vista

Endoskope / Optische Zange
Endoscopes / Optical Forceps
Endoscopios / Pinza opticaautoklavierbar / autoclavable / autoclavable
max. 134°C, 2,3 bar

Sinuskop - Sinuscope - Sinuscopio



Ø 2,7 mm, 175 mm

R400-027175-000 0°
R400-027175-030 30°
R400-027175-070 70°

Ø 4,0 mm, 175 mm

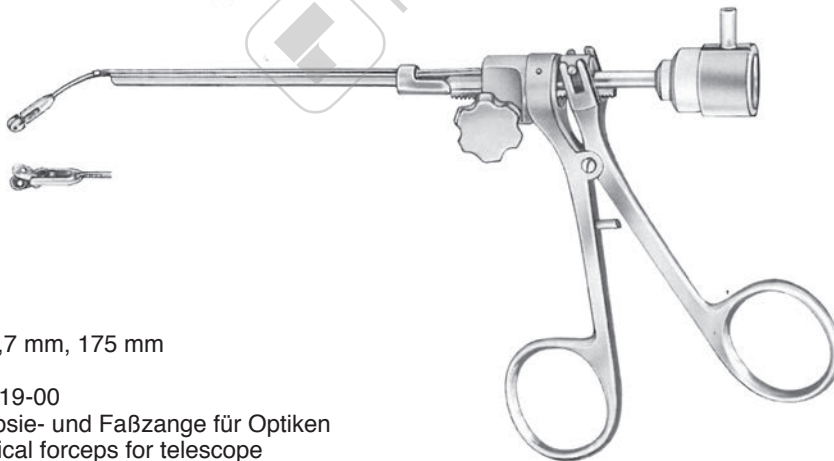
R400-040175-000 0°
R400-040175-030 30°
R400-040175-045 45°
R400-040175-070 70°

Ø 2,7 mm, 175 mm

47319-00
Biopsie- und Faßzange für Optiken
Optical forceps for telescope
Pinza optica de biopsia y agarre

Endoskope
Endoscopes
Endoscopios

autoklavierbar / autoclavable / autoclavable
max. 134°C, 2,3 bar

Pharyngoskop - Pharyngoscope - Faringoscopio

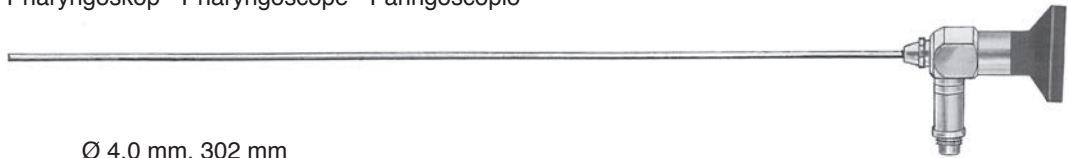

Ø 4,0 mm, 302 mm

R300-040302-000	0°
R300-040302-030	30°
R300-040302-070	70°

Wondershare
PDFelement

Endoskope
Endoscopes
Endoscopiosautoklavierbar / autoclavable / autoclavable
max. 134°C, 2,3 bar

Otoskop - Otoscope - Otoscopio

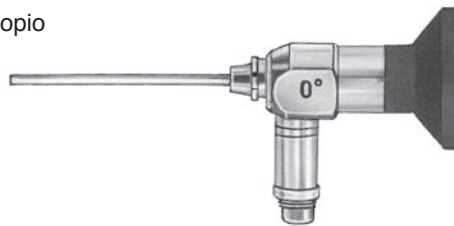

Ø 2,7 mm, 41 mm

R501-027041-000 0°

R501-027041-030 30°

Ø 4,0 mm, 50 mm

R501-040050-000 0°

R501-040050-030 30°

Laryngoskop - Laryngoscope - Laringoscopio



Ø 10 mm, 147,5 mm

R503-100148-070 70°

Ø 11 mm, 145 mm

R503-110145-090 90°

Ø 10 mm, 173 mm

R503-100173-070 70° mit Lichtleiter / integrated light cable / con portador de luz

Ø 11 mm, 173 mm

R503-110173-090 90° mit Lichtleiter / integrated light cable / con portador de luz

Endoskope
Endoscopes
Endoscopios

autoklavierbar / autoclavable / autoclavable
max. 134°C, 2,3 bar

Endoskop zur endolaryngealen Mikrochirurgie
Endoscope for endolaryngeal microsurgery
Endoscopio para microcirurgia endolaringeal

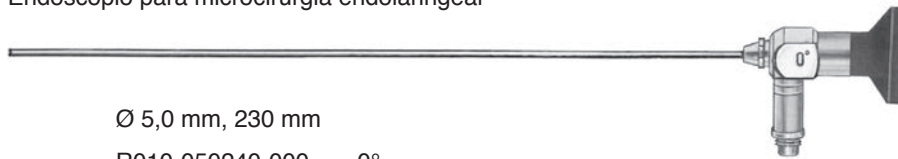

Ø 5,0 mm, 230 mm

R010-050240-000 0°

R010-050240-030 30°

R010-050240-070 70°

Bronchoskop - Bronchoscope - Broncoscopio

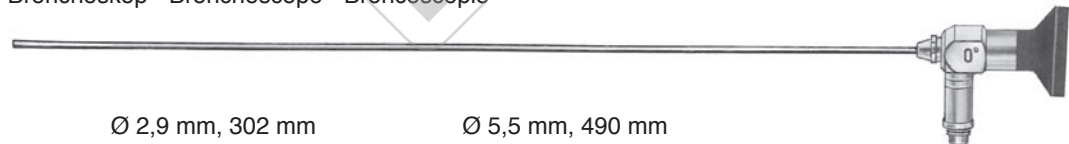

Ø 2,9 mm, 302 mm

R010-030302-000 0°

R010-030302-030 30°

Ø 5,5 mm, 490 mm

R010-055490-000 0°

R010-055490-030 30°

Fiberglas-Lichtkabel ohne Adapter
Light Guide Cables without Adapters
Cable de fibra optica sin adaptadores

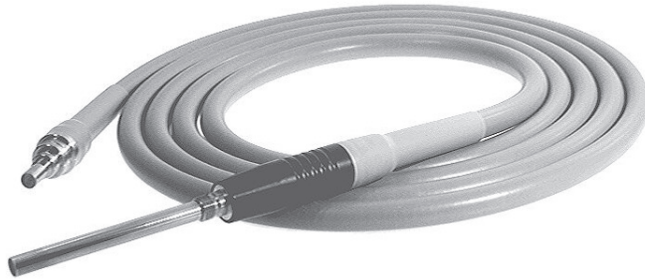

verklebt für Halogen Licht bonded for Halogen Light para luz halogena	Ø	cm	verschmolzen für Xenon Licht fused for Xenon Light para luz Xenon
R900-035180-00	3,5	180	R901-035180-00
R900-035230-00	3,5	230	R901-035230-00
R900-035300-00	3,5	300	R901-035300-00
R900-035350-00	3,5	350	R901-035350-00
R900-048180-00	4,8	180	R901-048180-00
R900-048230-00	4,8	230	R901-048230-00
R900-048250-00	4,8	250	R901-048250-00
R900-048300-00	4,8	300	R901-048300-00
R900-048350-00	4,8	350	R901-048350-00

Adapter
Adapters
Adaptadores



Adapter zu Lichtquelle
Adapters to light source
Adaptador a la fuente de luz

INNEN - IN - INTERIOR

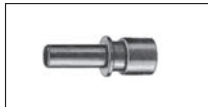

R900-000000-01
Storz / Aesculap

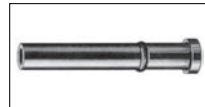

R900-000000-11
Fuji



R900-000000-03
Wolf / Henke Sass /
Dyonics / Medicon /
Comeg

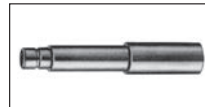

R900-000000-13
Heine-Optotechnik



R900-000000-05
ACM / British /
Codman

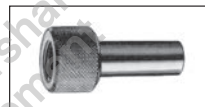

R900-000000-15
Winter+IBE

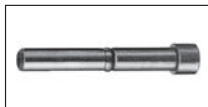

R900-000000-07
Olympus

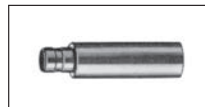

R900-000000-21
MLW

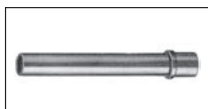

R900-000000-09
Pentax

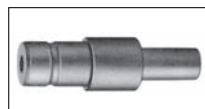

R900-000000-31
Volpi / Schöilly /
RFO



Adapter zu Endoskope
Adapter to Endoscope-side
Adaptador al endoscopio

AUSSEN - OUT - EXTERIOR



R900-000000-02
Storz / Winter+IBE /
Aesculap / Olympus



R900-000000-06
ACM / British /
Codman



R900-000000-04
Wolf

STIRNLAMPEN

HEAD LIGHTS

LÁMPARAS FRONTALES



Wondershare
PDFelement



Indikationen und Kontraindikationen finden Sie in der entsprechenden Gebrauchsanweisung!
Indication and Contraindication please refer to our user's manual!
Indicaciones y Contraindicaciones se encuentran en la instrucciones de uso correspondientes!

Nystagmusbrille
Nystagmus Spectacles
Anteojos para nistagmo



FRENZEL

03167-03
Beleuchtete Nystagmusbrille
mit querliegendem Batterie-
handgriff und festen Gläsern

03167-03
Nystagmus Spectacles for
observation of the eyes during
examination of the vestibular
apparatus, with battery handle
and fixed glasses. Illuminated
on inside of lenses.

03167-03
Anteojos para nistagmo, con
iluminación, con mango para
pilas en forma horizontal,
vidrios fijos,

Energiequelle:
2 Stück 4-Volt-Lämpchen
2 Stück Baby-Zellen 1.5 V

Source of energy:
2 bulbs 4-volt
2 baby-battery cells 1.5 V

Alimentación:
2 unidades de bombillas de
4 voltios
2 unidades de pilas de
1.5 voltios



03165-07
Ersatzlampe
Spare bulb
Bombilla de repuesto

Stirnspiegel
Head Mirror
Espejos frontales



03180-93
ø 90 mm



ZIEGLER
03180-90
compl.



03180-92

03180-90
Ziegler-Stirnspiegel,
komplett, mit schwarzem
Stirnreifen,
mit Kugelgelenk,
90 mm ø

03180-90
Ziegler Head Mirror,
complete with black head
band, with ball socket,
90 mm ø

03180-90
Ziegler espejo frontal,
completo con cinta negra,
con articulación,
90 mm ø

03180-92
Stirnreifen, allein

03180-92
head band, only

03180-92
cinta, suelta

03180-93
Spiegel, allein
90 mm ø

03180-93
Mirror, only
90 mm ø

03180-93
Espejo, suelto
90 mm ø

HNO Stirnleuchte
Miniature Headlight
Lampara frontal mini



03192-00

Fiberoptische Miniaturstirnleuchte für den OP-Bereich. Miniatur-Hochleistungs-Optik, Faserbündel- \varnothing 3,5 mm, heller / homogener Lichtfleck, ledergepolstertes Stirnband mit seitlichen Kopfstützen und Stellrad. Lieferung ohne Adapter für Lichtquelle.

03192-00

Fibre Optic miniature headlight for operation theatre. Perfect view by very small optic. The fibre bundle diameter of 3.5 mm and the double lens system effects a small and homogenous light spot with lateral head supports. Easily adjustable by hand wheel. Supplied without adapter for light source.

03192-00

Frontal de luz fría para profunda e intensiva iluminación. El cable de fibra optica de 3,5 mm de diametro y su sistema de doble lente ofrece una iluminacion clara y homogénea haz de luz con soportes laterales. Facilmente ajustable con el sistema de rueda. Suministrado sin adaptador para fuente de luz.



03192-01

wie 03192-00, aber Projektorseite 90°
same as 03192-00, but projector side 90° angled
como 03192-00, pero terminal para proyector angulado en 90°



03193-20

Adapter
Adapter
Adaptador

HNO Stirnleuchte, Kaltlicht
Headlight Microfocus, Fibre Optic
Lampara frontal mini, luz fria

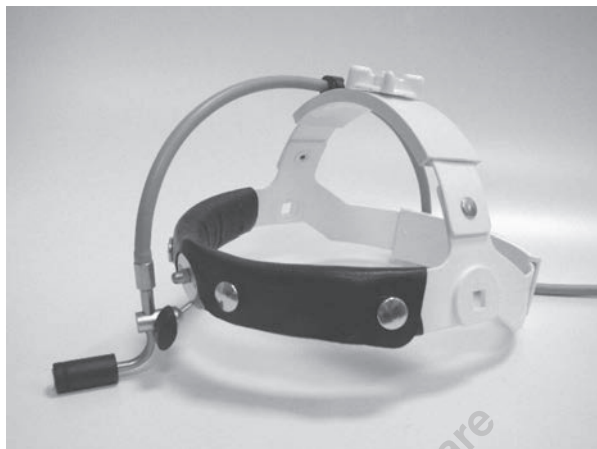

03193-00

Stirnlampe mit stufenlos variablem Mikrofokus zur blendfreien Tiefenausleuchtung. Durch kleinen Lichtaustritt und verstellbarer Kleinoptik optimales Sichtfeld. Komplett mit 2,2 m F/O-Kabel (Faserbündel- \varnothing 3,5 mm) und ledergepolstertem Kopfbügel-Stirnreif. Ohne Adapter für Lichtquelle.

03193-00

Headlight with stepless variable micro focus for intensive depth illumination. Very small focus. 2.2 m F/O cable (fibre bundle \varnothing 3.5 mm). Ergonomic and leather padded headband with crossband. Supplied without adapter for light source.

03193-00

Frontal de luz con focus variable y progresion continua con cable de 2,2 m largo y 3,5 mm de diámetro. Cabezal recubierto de piel e ergonómico. Se suministra sin adaptador para fuente de luz.



03193-01

wie 03193-00, aber Projektorseite 90°
same as 03193-00, but projector side 90° angled
como 03193-00, pero terminal para proyector angulado en 90°



03193-20

Adapter
Adapter
Adaptador

Stirnlampe
Head Light
Lámpara frontal



CLAR
03195-00

komplett mit Stirnstreifen und Kabel
complete with head band and cable
completo con cinta frontal y cable



03195-01
ø 55 mm

Spiegel aus Glas ohne Fassung
Glass Mirror without frame
Reflector de cristal, sin montura



03195-06
6 Volt



03195-07 Kleintransformator
220 Volt = 0 - 10 Volt / 3 Watt
Mini-Transformer Unit
Transformador eléctrico pequeño

03195-08 Kleintransformator
110 Volt = 0 - 10 Volt / 3 Watt
Mini-Transformer Unit
Transformador eléctrico pequeño

Stirnlampe
Head Light
Lámpara frontal

03194-00
Xenon Stirnlampe mit Batteriebox
Xenon headlight with battery box
Lámpara frontal Xenon con caja para batería



03194-01
Ersatzlampe mit Reflektor
Spare lamp with reflector
Lámpara de repuesto con reflector

Wondershare
PDFelement

03196-00
Kabellose OP-LED-Stirnleuchte,
schwarz, mit Kopfbügel und Akku

Wireless OP-LED-Headlight,
black, with headband

Lámpara frontal LED, inalámbrica,
negra con cinta y batería







BOHRER

BURRS

BROCAS

HADEO
INSTRUMENTE GERMANY

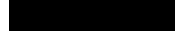

Indikationen und Kontraindikationen finden Sie in der entsprechenden Gebrauchsanweisung!
Indication and Contraindication please refer to our user's manual!
Indicaciones y Contraindicaciones se encuentran en la instrucciones de uso correspondientes!

Bohrer 70 mm, Schaft 2,35 mm
 Burrs, 70 mm, Schaft 2.35 mm
 Brocas, 70 mm, vástago 2,35 mm

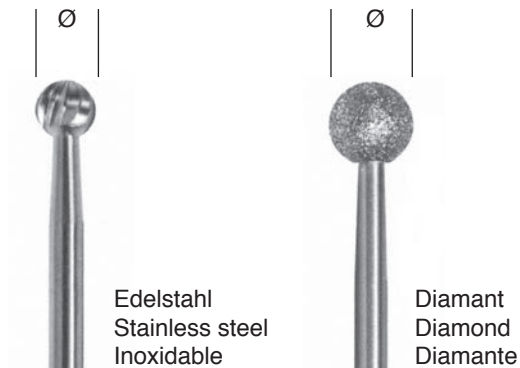

Edelstahl
 Stainless steel
 Inoxidable

Diamant
 Diamond
 Diamante

Ø 0,60 mm	50236-06	
Ø 0,70 mm		50242-07
Ø 0,80 mm	50236-08	50242-08
Ø 1,00 mm	50236-10	50242-10
Ø 1,40 mm	50236-14	
Ø 1,50 mm		50242-15
Ø 1,80 mm	50236-18	50242-18
Ø 2,00 mm		50242-20
Ø 2,30 mm	50236-23	50242-23
Ø 2,50 mm		50242-25
Ø 2,70 mm		50242-27
Ø 3,00 mm		50242-30
Ø 3,10 mm	50236-31	
Ø 3,50 mm	50236-35	50242-35
Ø 4,00 mm	50236-40	50242-40
Ø 4,50 mm	50236-45	50242-45
Ø 5,00 mm	50236-50	50242-50
Ø 6,00 mm	50236-60	50242-60
Ø 7,00 mm	50236-70	50242-70

Bohrer 70 mm, Schaft 2,35 mm
 Burrs, 70 mm, Schaft 2.35 mm
 Brocas, 70 mm, vástago 2,35 mm



Hartmetall
 Tungsten Carbide
 Tungsteno

Hartmetall grob
 Tungsten Carbide coarse
 Tungsteno grueso

Ø 0,60 mm	50237-06	
Ø 0,70 mm		
Ø 0,80 mm	50237-08	
Ø 1,00 mm	50237-10	
Ø 1,40 mm	50237-14	
Ø 1,50 mm		
Ø 1,80 mm	50237-18	
Ø 2,00 mm		
Ø 2,30 mm	50237-23	
Ø 2,50 mm	50237-25	
Ø 2,70 mm	50237-27	
Ø 3,00 mm	50237-30	
Ø 3,10 mm		
Ø 3,50 mm	50237-35	50238-35
Ø 4,00 mm	50237-40	50238-40
Ø 4,50 mm	50237-45	50238-45
Ø 5,00 mm	50237-50	50238-50
Ø 6,00 mm	50237-60	
Ø 7,00 mm	50237-70	



HOCHFREQUENZ-
CHIRURGIE

HIGH FREQUENCY
SURGERY

CIRUGIA DE ALTA
FRECUENCIA



Wondershare
PDFelement

HADEO
INSTRUMENTE GERMANY



Indikationen und Kontraindikationen finden Sie in der entsprechenden Gebrauchsanweisung!
Indication and Contraindication please refer to our user's manual!
Indicaciones y Contraindicaciones se encuentran en la instrucciones de uso correspondientes!

Hochfrequenz-Chirurgie
High Frequency Surgery
Electrocirugía

Mindestbestellmenge 10
Minimum order quantity 10
Cantidad minima 10



91010-01
Fig. 1



91010-02
Fig. 2 45°



91010-03
Fig. 3 120°



91010-11
Fig. 11
Ø 3 mm



91010-12
Fig. 12
Ø 5 mm



91010-13
Fig. 13
Ø 8 mm



91010-14
Fig. 14



91010-15
Fig. 15 45°
7,0x1,5 mm



91010-16
Fig. 16 45°
7 mm



91010-17
Fig. 17
6,0x1,3 mm



91010-18
Fig. 18 30°
7,0x1,7 mm



91010-21
Fig. 21
7,0x1,7 mm



91010-31
Fig. 31 45°
Ø 0,6 mm



91010-33
Fig. 33 45°
Ø 1,7 mm



91010-34
Fig. 34 45°
Ø 3,0 mm



91010-35
Fig. 35



91010-36
Fig. 36 90°

Schaft
shaft
vástago
Ø 2,4 mm

Mindestbestellmenge 10
Minimum order quantity 10
Cantidad minima 10

Hochfrequenz-Chirurgie
High Frequency Surgery
Electrocirugía



91011-51
Fig. 51 45°
Ø 3 mm



91011-52
Fig. 52 45°
7,0x1,7 mm



91011-53
Fig. 53 45°



91011-54
Fig. 54



91011-55
Fig. 55



91011-56
Fig. 56 45°
Ø 5 mm



91011-61
Fig. 61 45°



91011-62
Fig. 62 90°

Schaft
shaft
vástago
Ø 2,4 mm

Serie STANDARD



91020-01



91020-02

Schaft
shaft
vástago
Ø 4 mm



91020-03



91020-04



Ø mm
5 91022-05



Ø mm
10 91024-10



Ø mm
2 91030-02

Schaft
shaft
vástago
Ø 4 mm

10 91022-10
20 91022-20

15 91024-15
20 91024-20

4 91030-04
6 91030-06

Bipolare Koagulation
Bipolar Coagulation
Coagulación bipolar



91102-11
11 cm, 4 3/8"

91104-11
11 cm, 4 3/8"

91109-11
11 cm, 4 3/8"
45°
0.5 mm

91113-11
11 cm, 4 3/8"
45°
0.5 mm

91115-11
11 cm, 4 3/8"
45°
0.5 mm



91122-16
16,5 cm, 6 1/2"
0.5 mm

91123-16
16,5 cm, 6 1/2"
0.5 mm

91124-16
16,5 cm, 6 1/2"
1 mm

91125-16
16,5 cm, 6 1/2"
0.5 mm

91127-16
16,5 cm, 6 1/2"
1 mm

Bipolare Koagulation
Bipolar Coagulation
Coagulación bipolar



91142-16
16,5 cm, 6 □“
1 mm



91144-16
16,5 cm, 6 □“
0.5 mm



91146-16
16,5 cm, 6 □“
1 mm



91152-19
19,5 cm, 7 □“
0.3 mm



91154-19
19,5 cm, 7 □“
1 mm



91157-19
19,5 cm, 7 □“
1 mm



91159-19
19,5 cm, 7 □“
2 mm

Bipolare Koagulation
Bipolar Coagulation
Coagulación bipolar



91162-19
19,5 cm, 7 □“
0.3 mm



91164-19
19,5 cm, 7 □“
1 mm



91166-19
19,5 cm, 7 □“
2 mm



91167-19
19,5 cm, 7 □“
1 mm



91169-19
19,5 cm, 7 □“
1 mm



91172-03 - 91172-12
22,5 cm, 8.9“



91172-03
0,3 mm



91172-07
0,7 mm









91172-12
1,2 mm

Verbindungskabel, bipolar
Connection Cords, bipolar
Cables de conexión, bipolar

Unit side

Instrument side

	Cable length Meter	Flat plug europe	
			
Erbe / Storz 12,5 mm Ø 	3	R065-040125-003	R065-040125-103
	5	R065-040125-005	R065-040125-105
Martin / Berchtold 8 mm Ø AESCULAP Wolf 	3	R065-020080-003	R065-020080-103
	5	R065-020080-005	R065-020080-105
Valleylab / Lamidey / EMC 	3	R065-040285-003	R065-040285-103
	5	R065-040285-005	R065-040285-105
2-Pin U.S. Standard Eschmann 	3	R065-040000-003	R065-040000-103
	5	R065-040000-005	R065-040000-105

Bipolare Koagulation
Bipolar Coagulation
Coagulación bipolar

NON STICK

gerade
straight
recta



	0,3 mm	0,5 mm	1,0 mm	2,0 mm
11,0 cm, 4 3/8"	91110-03N	91110-05N	91110-10N	
16,0 cm, 6 1/4"	91160-03N	91160-05N	91160-10N	91160-20N
18,0 cm, 7"		91180-05N	91180-10N	91180-20N
19,5 cm, 7 3/4"		91200-05N	91200-10N	91200-20N
22,0 cm, 8 3/4"			91220-10N	91220-20N
24,0 cm, 9 1/2"			91240-10N	
30,0 cm, 12"			91300-10N	91300-20N

abgewinkelt 45°
angled 45°
angulada 45°



	0,3 mm	0,5 mm	1,0 mm	2,0 mm
11,0 cm, 4 3/8"	91112-03N	91112-05N	91112-10N	
16,0 cm, 6 1/4"		91162-05N	91162-10N	
18,0 cm, 7"			91182-10N	91182-20N
19,5 cm, 7 3/4"		91202-05N	91202-10N	91202-20N
22,0 cm, 8 3/4"			91222-10N	91222-20N
24,0 cm, 9 1/2"			91242-10N	

NON STICKBipolare Koagulation
Bipolar Coagulation
Coagulación bipolarbayonett gerade
bayonet straight
bayoneta recta

	0,3 mm	0,5 mm	1,0 mm	2,0 mm
16,0 cm, 6 □“	91166-03N	91166-05N	91166-10N	91166-20N
19,5 cm, 7 □“		91206-05N	91206-10N	91206-20N
22,0 cm, 8 □“		91226-05N	91226-10N	91226-20N
24,0 cm, 9 □“		91246-05N	91246-10N	91246-20N

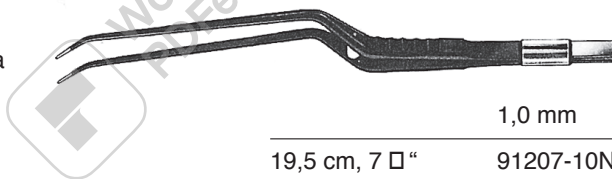
bayonett nach oben
bayonet upwards
bayoneta hacia arriba

	1,0 mm
19,5 cm, 7 □“	91207-10N
22,0 cm, 8 □“	91227-10N

bayonett nach unten
bayonet downwards
bayoneta hacia abajo

	0,5 mm	1,0 mm
16,0 cm, 6 □“	91168-05N	91168-10N
19,5 cm, 7 □“		91208-10N
22,0 cm, 8 □“		91228-10N

Bipolare Saugpinzetten
Bipolar Suction Forceps
Pinza de succión bipolar

Saugpinzetten zum Absaugen von Blut und Sekret vor der Koagulation bzw. zum Absaugen von Rauch während der Koagulation.

Europäischer Flachstecker zum Anschluß von bipolaren Kabeln für praktisch alle gebräuchlichen HF-Generatoren.

Der Saugkanal mit Unterbrecherloch ist in einem Schenkel der Pinzette integriert.

An der Schlaucholive können verschiedene Schlauchdurchmesser angeschlossen werden.

Suction forceps for extraction of blood and debris by suction right before coagulation or extraction of smoke while coagulating.

European flat socket connector for bipolar cables for nearly all common high frequency generators.

Suction channel integrated inside the forceps.

Suction connector matches different suction tube diameters.

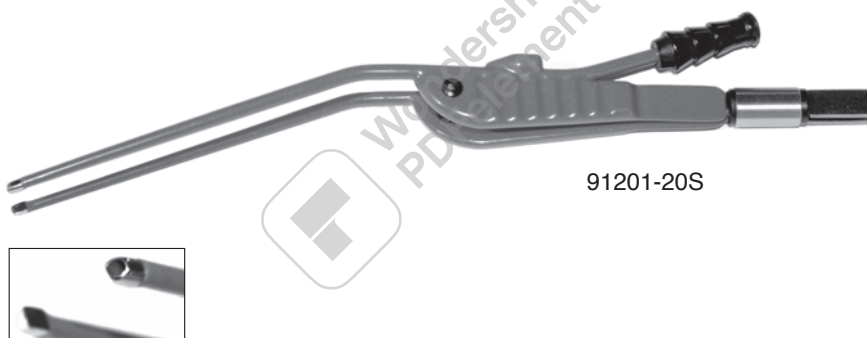

91201-20S

Pinza de succión para sangre y líquidos antes de efectuar la coagulación como también para la eliminación de humo durante la coagulación.

Enchufe plano europeo para conectar cables bipolares de equipos de alta frecuencia en uso corrientemente.

El canal de succión con su agujero de interrupción está incorporado en un lado de la pinza.

El diseño de la oliva de conexión permite la adaptación de tubos de varios diámetros.

Monopolar Saugkoagulator
Monopolar Suction Coagulator
Coagulador de succión monopolar antiadherente

NON STICK

gerade, biegsam
straight, malleable
recta, maleable



91179-18N
18 cm, 7"



Wondershare
PDFelement

Bipolare Stichkoagulationselektrode
Bipolar Stitch Coagulation Electrodes
Electrodos de coagulación de puncion, bipolar



Bipolare Koagulationselektrode MICRODOME
Bipolar Coagulation Elektrode MICRODOME
Electrodo de coagulación bipolar MICRODOME



91178-14
14 cm, 5 □"





OTOLOGIE

OTOLOGY

OTOLOGÍA

HADEO
INSTRUMENTE GERMANY

Indikationen und Kontraindikationen finden Sie in der entsprechenden Gebrauchsanweisung!
Indication and Contraindication please refer to our user's manual!
Indicaciones y Contraindicaciones se encuentran en la instrucciones de uso correspondientes!

Diagnostik-Bestecke mit Standardbeleuchtung
 Diagnostic Sets with Standard Illumination
 Estuches de diagnóstico con iluminación standard

UNI I



Nr. 03161-00

Weltbekanntes und preiswertes Otoskop mit Standardbeleuchtung 2,5 V. Besonders geeignet für Studenten und Ärzte.
Set bestehend: Aus Otoskopkopf verchromt, mit Steckverschluß. Verchromter Batteriegriff 28 mm \varnothing für 2 Batterien Typ C. Mit abnehmbarem Abdeckglas in Kunststoff-Fassung mit Plastikconnector für den pneumatischen Test. Die verchromte Schwenklinse ist abnehmbar und vergrößert 4,0-fach. Die Lichtstärke kann anhand des Rheostates reguliert werden. Mit 3 wiederverwendbaren Ohrtrichtern 2, 3 und 4 mm \varnothing . Komplett in silberfarbener Kunststofftasche.

No. 03161-00

World famous otoscope set at a budget price for physicians and students. 2,5 V standard illumination for use with 2 batteries type C.

Set includes: Otoscope head with pin contact fitting. Chrome-plated. Fixed protective lens in plastic mount may be removed for introduction of instruments. Plastic connector for pneumatic otoscopy. Removable swivel-mounted 4 x magnifier. 2, 3 and 4 mm reusable specula included. Battery handle 28 mm \varnothing for 2 C-cell batteries. Chrome-plated. With thumb wheel for securing pin contact heads. With rheostat for adjustment of illumination. Complete in silver-colored plastic pouch.

No. 03161-00

Otoscopio muy popular y económico con iluminación standard 2,5 V apropiado para estudiantes y médicos, de fama mundial.

Cabeza otoscopio cromada, con cierre de tornillo. Mango a pilas cromado 28 mm \varnothing para dos pilas tipo C. Con cristal de cubierto desmontable en armadura plástica. Con conector plástico para el test neumático. La lente giratoria es desmontable y amplifica 4,0 veces mas. La intensidad de la luz es regulable con el reostato. Con tres especulos reutilizables 2, 3 y 4 mm \varnothing . Completo en bolsa de plástico de color gris plata.

Diagnostik-Bestecke mit Standardbeleuchtung
Diagnostic Sets with Standard Illumination
Estuches de diagnóstico con iluminación standard

UNI II



Nr. 03161-01

Weltbekanntes und preisgünstiges May-Ophthalmoskop: mit Standardbeleuchtung 2,5 V. Besonders für Studenten und Ärzte geeignet. Ophthalmoskop mit Steckverschluß. Anhand des Linsenrades können Korrekturlinsen von 0 bis +20 und 0 bis -20 Dioptrien gewählt werden. Mit einer Blende: großer Kreis. Mit verchromtem Batteriegriff: 28 mm ø für 2 Batterien Typ C. Die Lichtstärke kann anhand des Rheostates reguliert werden. Komplett in silbergrauer Kunststofftasche.

No. 03161-01

World-famous ophthalmoscope set at a budget price for physicians and students. 2,5 V standard illumination for use with 2 batteries Type C. Set includes: May ophthalmoscope head: Pin contact fitting. Lens selection wheel permits choice of corrective lenses from 0 to +20 and 0 to -20 diopters. Single large circle aperture. Battery handle: 28 mm ø for 2 C-cell batteries. Chrome-plated. With thumb wheel for securing pin-contact heads. Rheostat for adjustment of illumination. Complete in silver-gray plastic pouch.

No. 03161-01

Oftalmoscopio May: muy popular y económico con iluminación standard 2,5 V, apropiado para estudiantes y médicos de fama mundial. Oftalmoscopio con cierre de tornillo. Con ayuda de la rueda de lentes se puede elegir lentes de corrección de 0 a +20 y o a -20 dioptrías. Y con una apertura: gran círculo. Con mango a pilas: cromado 28 mm ø para dos pilas tipo C. La intensidad de la luz es regulable con el reostato. Completo en bolsa de plástico de color gris plata.

Diagnostik-Bestecke mit Standardbeleuchtung
 Diagnostic Sets with Standard Illumination
 Estuches de diagnóstico con iluminación standard

UNI III



Nr. 03161-02

Weltbekanntes diagnostisches Besteck mit Standardbeleuchtung 2,5 V. Äußerst beliebt und sehr preiswert. Besonders geeignet für Studenten und Ärzte. Das Set besteht aus folgenden Teilen: Otoskopkopf verchromt, mit Steckverschluß. Abnehmbares Abdeckglas in Kunststofffassung, mit Plastikconnector für pneumatischen Test. Abnehmbarer Schwenklinse (Vergrößerung 4,0-fach). 3 wiederverwendbaren Ohrtrichtern 2, 3 und 4 mm \varnothing . May-Ophthalmoskop mit Steckverschluß. Anhand des Linsenrades können Korrekturlinsen von 0 bis +20 und 0 bis -20 Dioptrien gewählt werden. Mit einer Blende: großer Kreis. Batteriegriff verchromt, 28 mm \varnothing für 2 Batterien Typ C. Die Lichtstärke kann anhand des Rheostates am Batteriegriff reguliert werden. Alle Teile komplett in silbergrauer Kunststofftasche.

No. 03161-02

World-famous otoscope/ophthalmoscope diagnostic set at a budget price for physicians and students. 2,5 V Standard illumination for use with 2 batteries type C. Set includes: Otoscope head - Pin contact fitting. Chrome-plated. Fixed protective lens in plastic mount may be removed for introduction of instruments. Plastic connector for pneumatic otoscopy. Removable swivel-mounted 4 x magnifier. 2, 3 and 4 mm reusable specula included. May ophthalmoscope head. Pin contact fitting. Lens selection wheel permits choice of corrective lenses from 0 to +20 and 0 to -20 diopters. Single large circle aperture. Battery handle. 28 mm \varnothing for 2 C-cell batteries. Chrome-plated. With thumb wheel for securing pin-contact heads. Rheostat for adjustment of illumination.

No. 03161-02

Este estuche de diagnóstico con iluminación standard 2,5 V es muy popular y muy económico, apropiado para estudiantes y médicos. Juego, compuesto de: Cabeza otoscopio cromado, con cierre de tornillo. Con cristal de cubierto en armadura plástica, con conector plástico para el test neumático. Con lente giratorio desmontable (amplificación: 4 veces más). Cabeza oftalmoscopio May con cierre de tornillo. Con ayuda de la rueda de lentes se puede elegir lentes de corrección de 0 a +20 y 0 a -20 dioptrías. Con una apertura: gran círculo. Mango a pilas cromado, 28 mm \varnothing para dos pilas tipo C. La intensidad de la luz es regulable con el reostato al tope del mango. Todos los partes se presentan en una bolsa plástica de color gris plata.

Diagnostik-Bestecke mit Standardbeleuchtung
Diagnostic Sets with Standard Illumination
Estuches de diagnóstico con iluminación standard



ECO "T" 03161-03T

- a) Otoskop, mit Schraubverschluss und 3 Ohrtrichtern, 2-3-4 mm
Otoscope with screw fitting and 3 ear speculas with, 2-3-4 mm
Otoscopio, con cierre a tornillo y con 3 espéculos auriculares de 2-3-4 mms
- b) Ophthalmoskop, 0 bis +20 und 0 bis -20 Dioptrien, mit Schraubverschluss
Ophthalmoscope from 0 to +20 and 0 to -20 dioptres with screw fitting
Oftalmoscopio, 0 a + 20 y 0 a - 20 dioptrías, con cierre a tornillo
- c) Nasenspekulum
Nasal Speculum
Espéculo nasal
- d) Lampenträger mit Schraubverschluss
Bent arm illuminator with screw fitting
Porta-lámpara, con cierre a tornillo
- e) 2 Kehlkopfspiegel No. 3 und 4
2 laryngeal mirrors no. 3 and 4
Espejos laringeos Nos. 3 y 4
- f) Mundspatelhalter
Tongue blade holder
Abaja-lenguas
- g) Batteriegriff für 2 Batterien mit Schraubverschluss (ohne Batterien)
Battery handle for 2 batteries
Mango para 2 pilas, con cierre a tornillo (sin pilas)
- h) Ersatzlämpchen 2.5 V
Spare lamp 2.5 V
Bombillo de repuesto 2.5 V

ECO "C" 03161-03C

Inhalt gleich wie oben, mit drehbarem Schnellverschluss.
Contents same as above, but with quick plug-in connector.
Mismo contenido como arriba pero con CIERRE RAPIDO GIRATORIO.

Diagnostik-Bestecke mit Xenonbeleuchtung Diagnostic Sets with Xenon Illumination Estuches de diagnóstico con iluminación Xenon



RI-MINI

Kleine, sehr moderne Qualitätsinstrumente aus Kunststoff, grau, mit Xenonbeleuchtung XL 2,5 V. Sehr preiswert und aufgrund der Größe besonders gut für die Arzttasche geeignet. Schraubverschluss. Otoskop: Fiber-Optik. Anschluß für pneumatischen Test. Lupe vergrößert 2,5-fach. Batteriegriff für 2 Batterien Typ AA. Ophthalmoskop: Korrekturlinsen: 0 bis +20 und 0 bis -20 Dioptrien. Blenden: Kreis groß + klein, Halbkreis, Fixierstern und Grünfilter. Griff für 2 Batterien Typ AA. Das Otoskop- und das Otoskop/Ophthalmoskop-Besteck werden jeweils mit einem Metallkonnektor für pneumatischen Test und Plastikröhrchen mit jeweils 5 wiederverwendbaren Ohrtrichtern 2,5 und 4,0 mm geliefert. Komplet in modernem schwarzen Kunststoffetui.

Nr. 03171-00 - Otoskop mit Griff AA.

Nr. 03171-01 - Ophthalmoskop mit Griff AA.

Nr. 03171-02 - Otoskop/Ophthalmoskop jeweils mit Griff AA.

Economically priced state-of-the-art quality instrument made of plastics, gray color, with Xenon illumination XL 2,5 V. Due to its small size it is most suitable for each practitioner's bag. Otoloscope: Fiber optic. Screw type fitting. 2,5 x magnifying glass. Battery handle for 2 AA-cell batteries. Ophthalmoscope: Corrective lenses ranging from 0 to +20 and 0 to -20 diopters. Apertures: large and small circle, semi-circle, fixation star and green filter. Otoloscope and otoscope/ophthalmoscope set each contain a metal connector for pneumatic otoscopy as well as plastic tube with 5 each reusable ear specula 2,5 and 4,0 mm. All sets come in modern black plastic case.

No. 03171-00 - Otoloscope with AA-handle.

No. 03171-01 - Ophthalmoscope with AA-handle.

No. 03171-02 - Otoloscope/ophthalmoscope with 1 each AA-handle.

Instrumentos de calidad, muy moderno y pequeño de plástico resistente, gris, con iluminación Xenon XL 2,5 V. Muy económico y gracias al tamaño apropiado para el bolsillo del médico. Cierre roscado. Otoscopio: fibra óptica. Conexión para test neumático. Lupa aumenta 2,5 veces más. Mango a pilas para 2 pilas, tipo AA. Oftalmoscopio: Lentes de corrección: 0 hasta +20 y 0 hasta -20 dioptrías. Aberturas: círculo grande y pequeño, semicírculo, estrella fijadora y filtro verde. Con mango para 2 pilas, tipo AA. Juego de otoscopio y de otoscopio/oftalmoscopio con conector metálico para el test neumático y con 5 espéculos reutilizables de 2,5 y 4,0 mm en tubo de plástico. Todos los juegos se presentan en estuche de plástico negro moderno.

No. 03171-00 - Otoscopio con mango AA.

No. 03171-01 - Oftalmoscopio con mango AA.

No. 03171-02 - Oto/oftalmoscopio con mangos AA.

Ohrspekula
Ear Specula
Espéculos auriculares



POLITZER
45009-00
Set = 3

- Innen Ø
- = 2,0 mm
45009-02
 - = 3,0 mm
45009-03
 - = 4,0 mm
45009-04



HARTMANN
45010-00
Set = 4,5 - 7,5 mm

- Innen Ø
- = 2,0 mm
45010-20
 - = 3,0 mm
45010-30
 - = 4,5 mm
45010-45
 - = 5,5 mm
45010-55
 - = 6,5 mm
45010-65
 - = 7,5 mm
45010-75



HARTMANN
45011-00
Set 3-7 mm

- schwarz
black
negro
- Innen Ø
- = 2,0 mm
45011-03
 - = 3,5 mm
45011-04
 - = 5,0 mm
45011-05
 - = 6,5 mm
45011-07
 - = 7,5 mm
45011-08



TOYNBEE
45012-00
Set = 5,5 - 7,5 mm

- Innen Ø
- = 4,0 mm
45012-40
 - = 5,5 mm
45012-55
 - = 6,5 mm
45012-65
 - = 7,5 mm
45012-75



GRUBER, rund
45014-00
Set = 4

- Innen Ø
- = 4,5 mm
45014-45
 - = 5,5 mm
45014-55
 - = 6,5 mm
45014-65
 - = 7,5 mm
45014-75

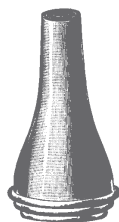

GRUBER, oval
45015-00
Set = 3

- Innen Ø
- = 4,5 mm
45015-45
 - = 5,5 mm
45015-55
 - = 6,5 mm
45015-65



BOUCHERON
45018-00
Set = 4

- Innen Ø
- = 5,0 mm
45018-50
 - = 6,0 mm
45018-60
 - = 7,0 mm
45018-70
 - = 8,0 mm
45018-80

Ohrspekula
Ear Specula
Espéculos auriculares

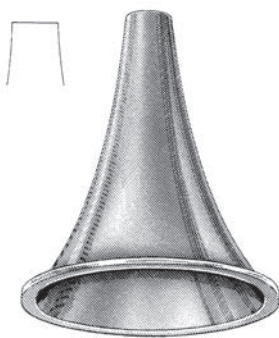
**FARRIOR**

45019-30	3,0 x 4,0 mm
45019-40	4,0 x 5,0 mm
45019-45	4,5 x 5,5 mm
45019-50	5,0 x 6,0 mm
45019-55	5,5 x 6,5 mm
45019-60	6,0 x 7,0 mm
45019-65	6,5 x 7,5 mm
45019-70	7,0 x 8,0 mm
45019-75	7,5 x 8,5 mm

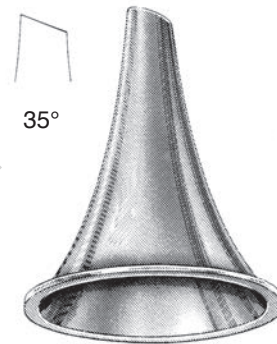
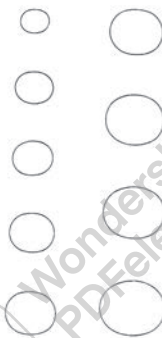
**FARRIOR**

45020-30	3,0 x 4,0 mm
45020-40	4,0 x 5,0 mm
45020-45	4,5 x 5,5 mm
45020-50	5,0 x 6,0 mm
45020-55	5,5 x 6,5 mm
45020-60	6,0 x 7,0 mm
45020-65	6,5 x 7,5 mm
45020-70	7,0 x 8,0 mm
45020-75	7,5 x 8,5 mm

Ohrspekula
Ear Specula
Especulos auriculares

6,5 mm



45030-06

7,5 mm



45030-07

8,2 mm



45030-08

10 mm

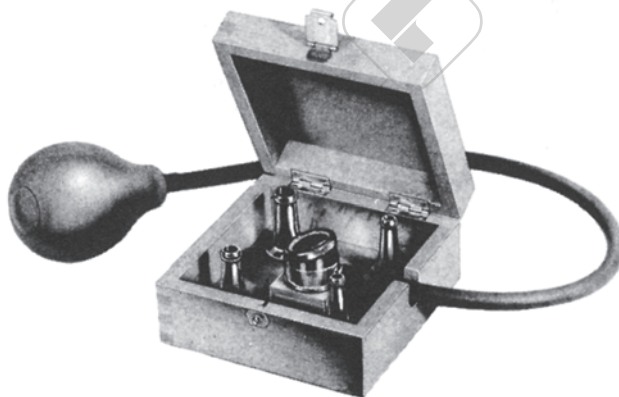

45030-10

BRUENINGS
45030-04

45030-04

Komplett bestehend aus:
4 Spekula, Saugkammer mit
Gebläse, HolzetuiComplete consisting of:
4 specula, suction head and rubber
tube with bulb, wooden caseCompuesto de:
4 espéculos, cámara de aspiración,
insuflador de goma, en estuche de
madera

Ersatzteile / spare parts / repuestos

45036-09

Lupe / Magnification glass / lupa

45036-10

Saugpumpe / rubber ball / pera de
goma

Ohrspekula
Ear Specula
Espéculos auriculares



7,5 mm Ø



45036-06



8,5 mm Ø



45036-07



9,5 mm Ø



45036-08

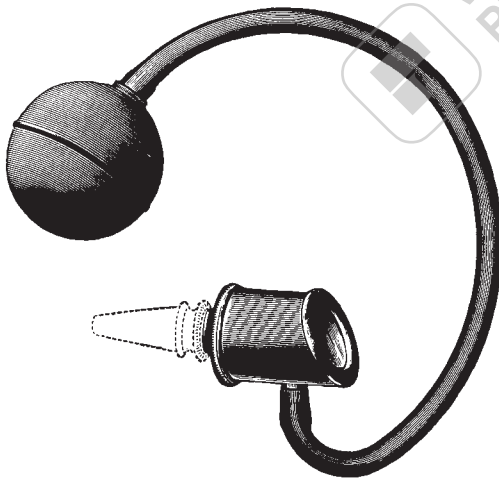

45036-03
Komplett bestehend aus:
Ohrspekulum, 3 Spekula, 1 Gebläse

Complete consisting of:
Ear Specula, 1 rubber tube with bulb

Completo, compuesto de:
Otoscopio con 3 espéculos, insuflador y tubo

SIEGLE
45036-03

Ohrspekulahalter
Ear Specula Holder
Soporte para espejos auriculares

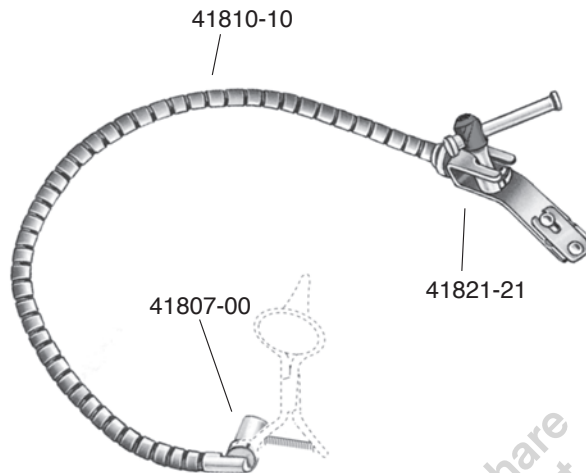

YASARGIL

- 41803-01 Ohrspekulahalter, komplett, bestehend aus:
ear specula holder, complete, consisting of:
soporte para espejos auriculares completo, compuesto de:
- 41810-10 flexibler Spannarm
flexible arm, only
brazo flexible, suelto
- 41821-21 Fixiervorrichtung zum Befestigen an Rohrteilen bis Ø 16 mm
clamp for fixation on bars up to Ø 16 mm
dispositivo de fijacion para tubos hasta Ø 16 mm



- 41807-00
Ohrspekulahalter alleine
Ear specula holder only
Soporte para espejos auriculares, suelto

Stimmgabeln
Tuning Forks
Diapasones

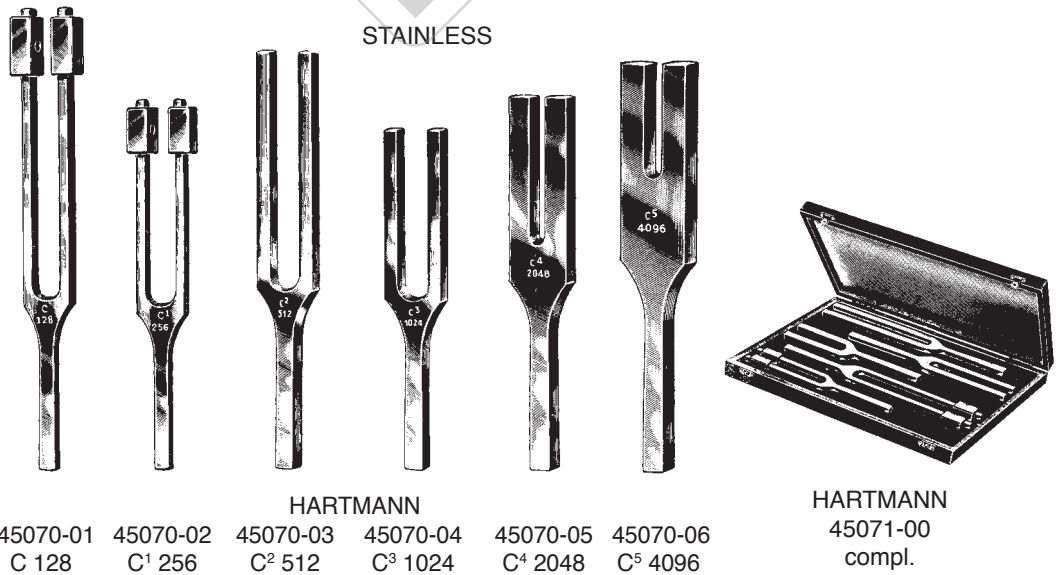
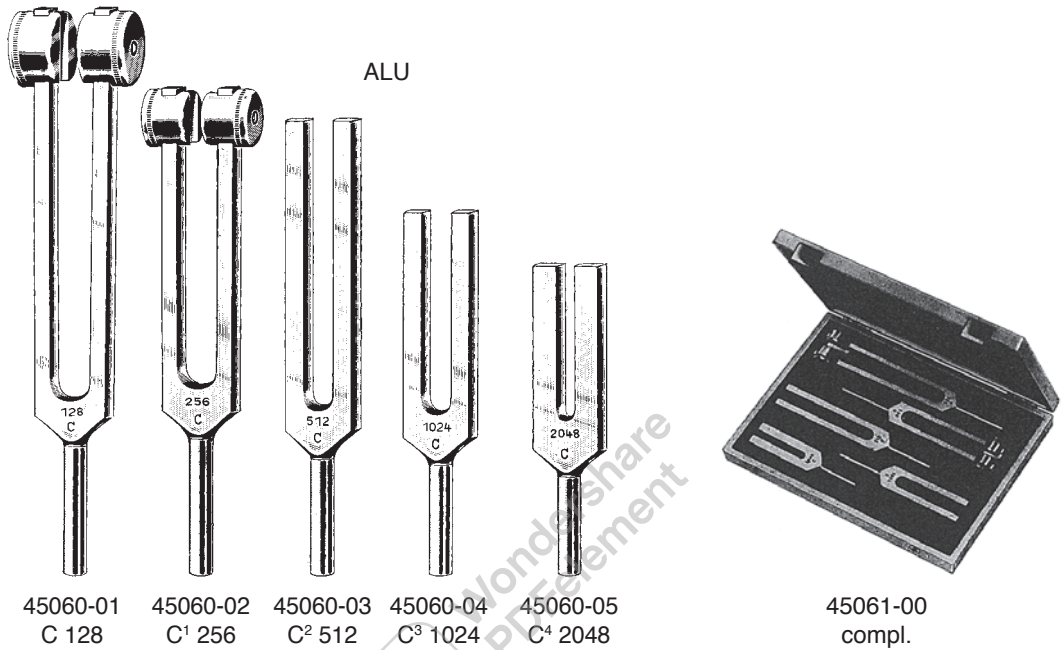

Stimmgabeln
Tuning Forks
Diapasones



45072-01
a¹ 440



LUCAE

- 45073-01 C 128
- 45073-02 C¹ 256
- 45073-03 C² 512
- 45073-04 C³ 1024
- 45073-05 C⁴ 2048
- 45073-06 C⁵ 4096



LUCAE
45074-01
C 128

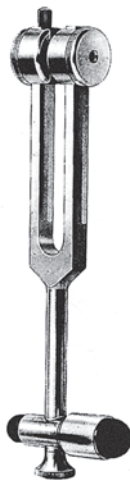

45075-00

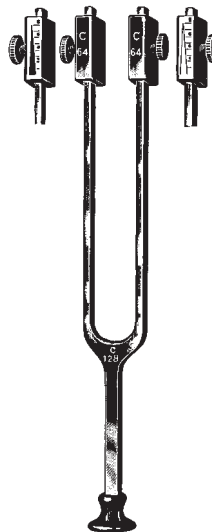

RYDEL-SEIFFERT
45076-01 C 128 / C 64

Lärmtrommel, Pulverbläser
Noise Apparatus, Powder Blowers
Ensordecador, Lanzapolvo



BARANY
45080-00

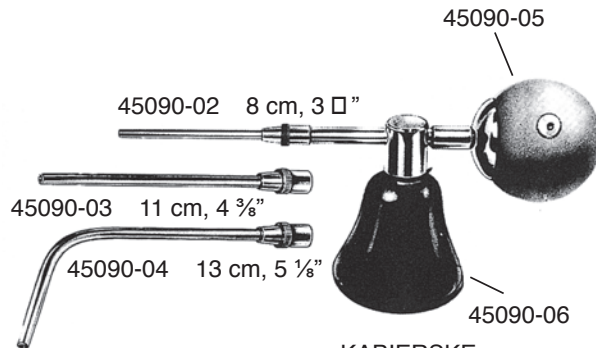

KABIERSKE
45090-00 30 ccm

komplett mit 3 Kanülen und Gummiball
complete with 3 cannulas and rubber bulb
completo con 3 cánulas y pera de goma

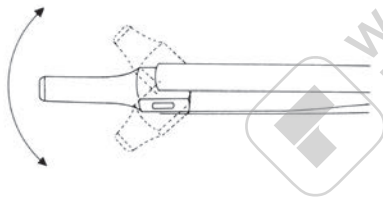

UNIVERSAL
45090-08

komplett mit beweglicher Düse,
Schraubflasche 30 ccm und Halbgebläse

complete with movable tube, screw bottle
30 ccm and rubber bulb

completo con tubo móvil, botella con rosca de
30 ccm y pera de goma

Luftdusche, Ohrspritze
Air Bag, Ear Syringe
Insuflador de aire, Jeringa auricular

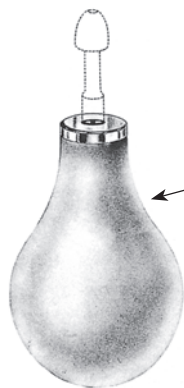

45091-02
Gummibirne alleine
Rubber bulb only
Pera de goma, sola



45091-03



45091-04
4 mm Ø



45091-15
15 mm Ø



45091-17
17 mm Ø



45091-22
22 mm Ø

POLITZER
45091-00 Set
incl.
45091-03
45091-15
45091-17
45091-22

POLITZER
45091-01 Set
incl.
45091-03
45091-04
45091-15
45091-17
45091-22

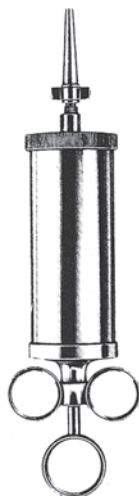

ml REINER, compl.
50 45096-50
75 45096-75
100 45097-10
150 45097-15

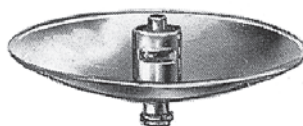

45097-01



45097-02



45097-03

Ohrspritze
Ear Syringe
Jeringa auricular

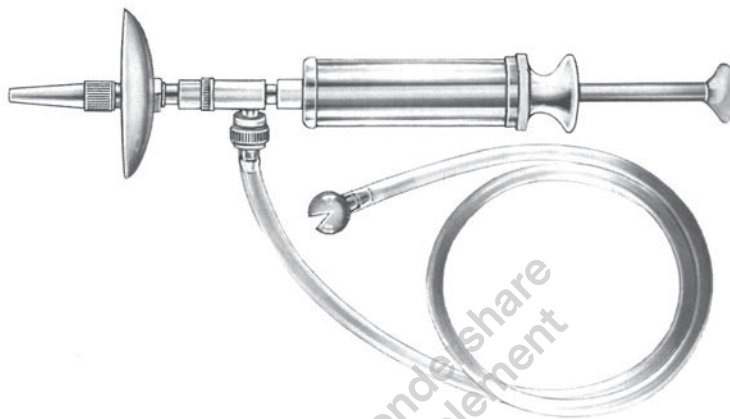

45096-00

Ohrspritze komplett, 10 ml selbstfüllend mit Luer-Lock Ansatz
Ear syringe, 10 ml one hand filling and emptying, Luer-Lock attachment
Jeringa auricular, 10 ml, con conexión Luer-Lock

Ohrsonden, Watteträger
Ear Probe, Cotton Applicators
Sondas auriculares, Porta-algodones

ø 1 mm
Silber



STACKE
21115-10
10,5 cm 4.1"

ø 1,2 mm

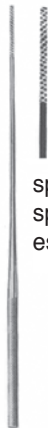

spiralförmig
spiral threads
estrías espirales

FARRELL

4 □ " 21270-12 12,0 cm
5 □ " 21270-14 14,0 cm
6 □ " 21270-16 16,5 cm

ø 1,2 mm



FARRELL

21272-12 12,0 cm
21272-14 14,0 cm
21272-16 16,5 cm

ø 1 mm



spiralförmig
spiral threads
estrías espirales

FROHN

4 □ " 21277-12 12,0 cm
5 □ " 21277-14 14,0 cm
6 □ " 21277-16 16,0 cm

Watteträger
Cotton Applicators
Porta-algodones



spiralförmig
spiral threads
estrías espirales



HADEO
21290-12 12,0 cm, 4 □“
21290-14 14,0 cm, 5 □“
21290-16 16,0 cm, 6 □“

HADEO
21292-12 12,0 cm, 4 □“
21292-14 14,0 cm, 5 □“
21292-16 16,0 cm, 6 □“



UCKERMANN
21310-15 15 cm, 6“

ø 3 mm



JOBSON-HORNE
21320-12 12 cm, 4 □“
21320-18 18 cm, 7“

Löffel, Schlingen, Hebel
Ear Spoons, Loops, Elevator
Cucharas, Asas, Elevador



GROSS
45171-12
12 cm, 4 □"



GROSS
45173-12
12 cm, 4 □"



45180-01



45180-02



45180-03

BILLEAU
16 cm, 6 □"



LANGENBECK
45181-13
13 cm, 5 1/8"



ZAUFAL
45184-16
16 cm, 6 □"



ZAUFAL-JANSEN
45185-15
15 cm, 6"

Häkchen
Ear Hooks
Ganchitos

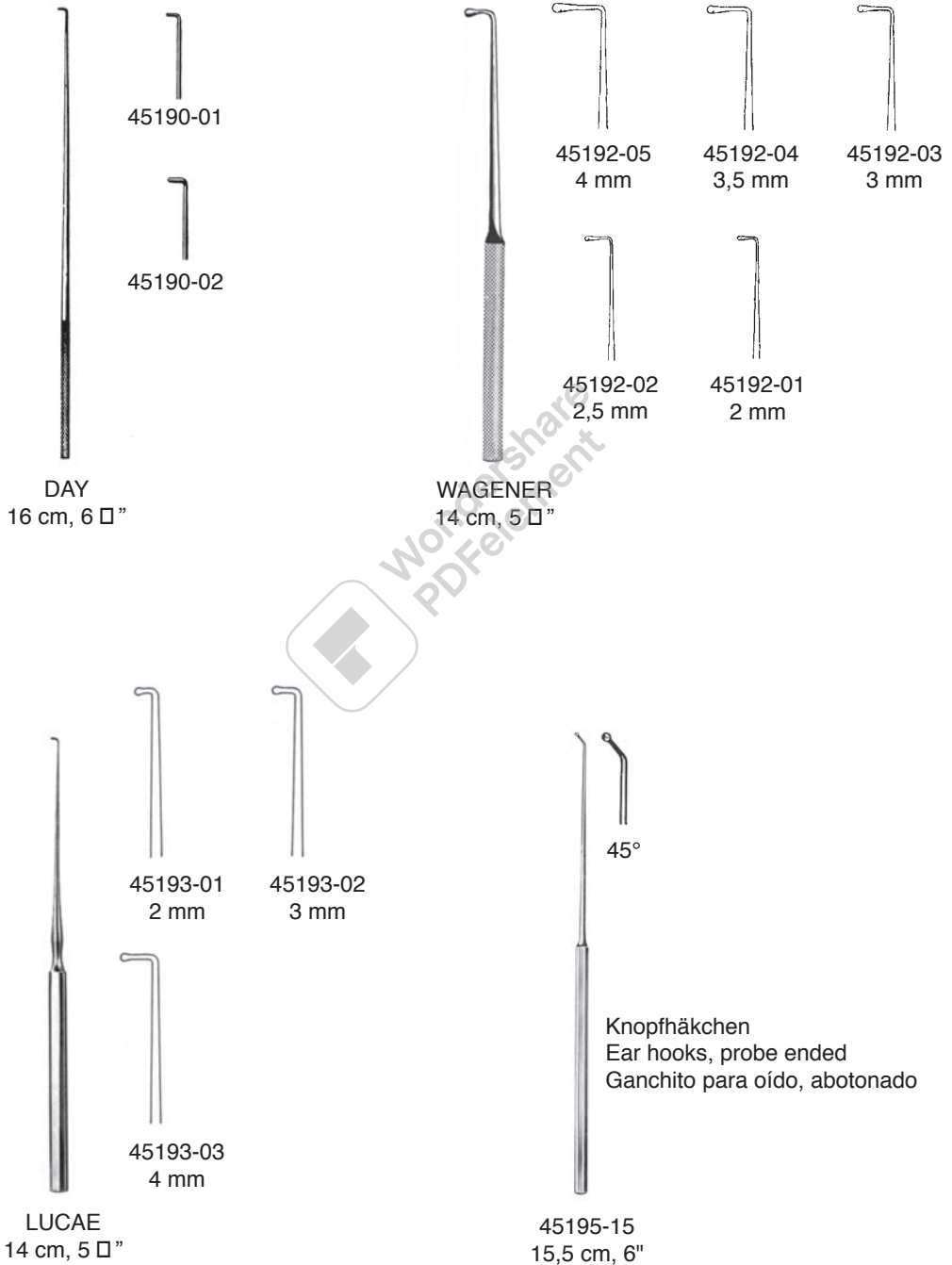

Ohrschlingen
Ear Loops
Lazos auriculares



45194-01



45194-02



45194-03



45194-04



SHAPLEIGH
13 cm, 5 1/8"



45195-00



45195-01















45195-02









WEBER-LOCH
16 cm, 6 1/8"

Ohrküretten
Ear Currettes
Curetas auriculares

	Innen Ø Inner Ø interior Ø	1.5 mm	1.9 mm	2.5 mm	2.7 mm
Küretten Currettes Curetas					
		Fig. 00	0	1	2
stumpf blunt romas	 	45109-00	45110-00	45110-01	45110-02
scharf sharp cortantes	 	45111-00	45112-00	45112-01	45112-02
stumpf blunt romas	 	45114-00	45115-00	45115-01	45115-02
scharf sharp cortantes	 	45116-00	45117-00	45117-01	45117-02

BUCK
14,5 cm, 5 □"

Ohrküretten
Ear Currettes
Curetas auriculares

	Innen Ø Inner Ø interior Ø	3.4 mm	4.0 mm	4.5 mm
Küretten Currettes Curetas				
		3	4	5
stumpf blunt romas		45110-03	45110-04	45110-05
scharf sharp cortantes		45112-03	45112-04	45112-05
stumpf blunt romas		45115-03	45115-04	45115-05
scharf sharp cortantes		45117-03	45117-04	45117-05

BUCK
14,5 cm, 5 □"

Ohrkatheter, Trommelfellnadel
Catheters, Tympanum Knives
Cateteres, agujas para timpano

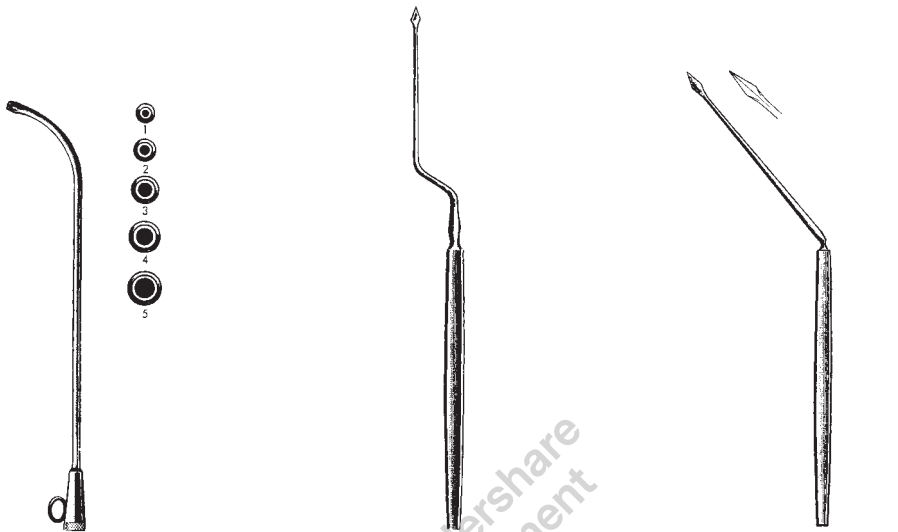

Fig. HARTMANN
1 45133-01 2,5 mm
2 45133-02 3,0 mm
3 45133-03 3,5 mm
4 45133-04 4,0 mm
5 45133-05 5,0 mm

POLITZER
45150-18
18 cm, 7"

POLITZER
45151-16
16,5 cm, 6 1/2"



für Kinder
for children
para niños

LUCAE
45152-01
18 cm, 7"



für Erwachsene
for adults
para adultos

LUCAE
45152-02
18 cm, 7"

Trommelfellnadel
Tympanum Knives
Cuchillos para timpano

mit Schraubgriff
with screw-locking handle
con mango roscado



POLITZER
45153-16
16 cm, 6 1/4"



POLITZER
45160-15
15 cm, 6"



SEXTON
45162-18
18 cm, 7"



SEXTON
45164-17
17 cm, 6 3/4"



SEXTON
45165-17
17 cm, 6 3/4"

Ohrpolypenschnürer
Ear Polypus Snares
Polipotomos auriculares

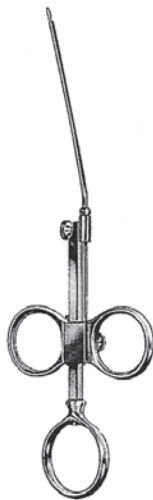

KRAUSE
45220-16
16 cm, 6 □"

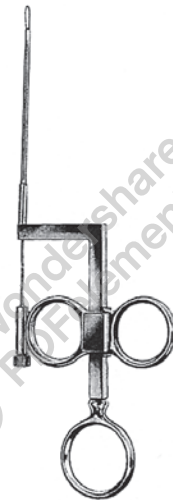

WILDE
45222-17
17 cm, 6 □"



45225-02
doz./doc./dozz.
0,2 mm

Fremdkörperheber
Foreign Body Levers
Elevadores para cuerpos extraños



QUIRE
45251-10
10 cm, 4"

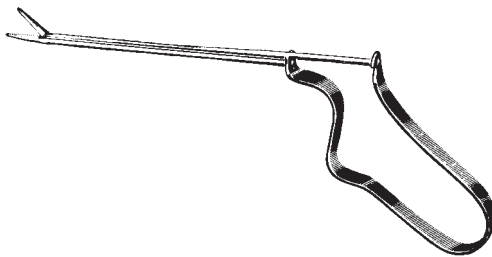

BUCK
45253-11
11 cm, 4 3/8"

Ohrzängchen
Ear Forceps
Pinzas auriculares

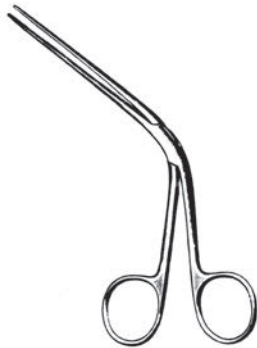

TILLEY
45243-14
14 cm, 5 □"



LITTAUER
45245-12
12 cm, 4 □"



HARTMANN
45246-12
12 cm, 4 □"



HARTMANN
45246-14
14 cm, 5 □"

Mikro Ohrzängchen
Micro Ear Forceps
Micro pinzas auriculares

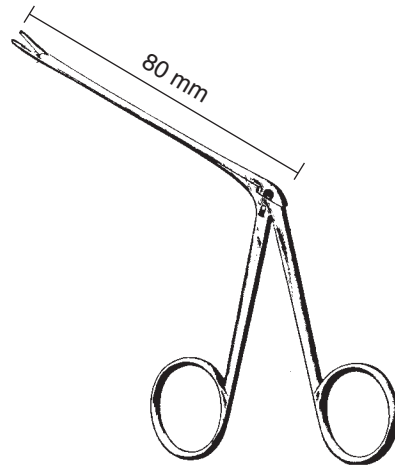

o 1 mm Ø



HARTMANN-WULLSTEIN
45255-08
8,5 cm, 3.4"



HARTMANN-WULLSTEIN
45257-08
8,5 cm, 3.4"



HARTMANN
45261-08 8,5 cm, 3.4"
45261-14 14,0 cm, 5 1/2"
45261-16 16,0 cm, 6 1/2"



HARTMANN
45263-08 8,5 cm, 3.4"
45263-14 14,0 cm, 5 1/2"



HARTMANN
45265-08
8,5 cm, 3.4"



Ø mm **HARTMANN**
2,0 45267-20 8,5 cm, 3.4"
2,5 45267-25 8,5 cm, 3.4"
3,0 45267-30 8,5 cm, 3.4"

3 mm Ø



HARTMANN
45269-30
8,5 cm, 3.4"



STRUEMPEL
45271-08 8,5 cm, 3.4"
2,5x5 mm



HARTMANN
45273-08
8,5 cm, 3.4"

o 2 mm Ø



HARTMANN-WEINGÄRTNER
45274-08
8,5 cm, 3.4"



HARTMANN-HOFFMANN
45275-08
8,5 cm, 3.4"



45276-08 Entenschnabel
14 cm, 5 1/2" Duckbill
Pico de pato

Mikro Ohrzängchen
Micro Ear Forceps
Micro pinzas auriculares

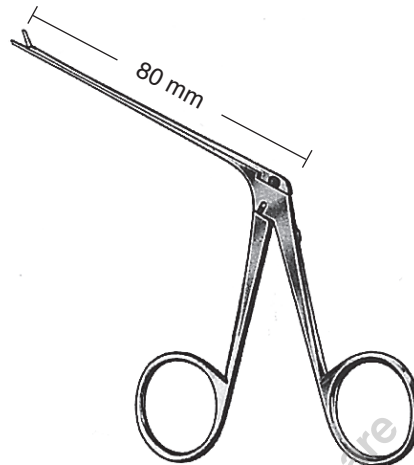

A
45350-40
0,9 x 4 mm



A
45350-70
0,9 x 7 mm



A
45352-40
0,9 x 4 mm

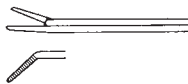

C
45353-60
0,9 x 6 mm



B
45355-60
0,9 x 6 mm



D
45357-40
0,9 x 4 mm



E
45359-40
0,9 x 4 mm



A
45360-35
0,6 x 3 mm

extra zart
very delicate
muy fina

- A: gerade / straight / recta
- B: rechts / right / derecha
- C: links / left / izquierda
- D: aufgebogen / curved up / curva hacia arriba
- E: nach unten gebogen / curved down / curva hacia abajo

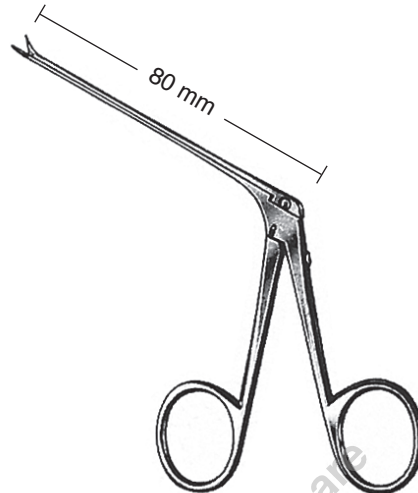
Mikro Ohrzängchen
Micro Ear Forceps
Micro pinzas auriculares

A

45361-01
0,6 x 4,5 mm45362-45
0,9 x 4,5 mm

C

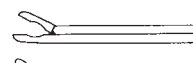
45361-02
0,6 x 4,5 mm45363-45
0,9 x 4,5 mm

B

45361-03
0,6 x 4,5 mm45365-45
0,9 x 4,5 mm

D

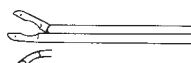
45361-04
0,6 x 5,0 mm45367-50
0,9 x 5,0 mm

E

45361-05
0,6 x 5,0 mm45369-50
0,9 x 5,0 mm

- A: gerade / straight / recta
 B: rechts / right / derecha
 C: links / left / iz quierda
 D: aufgebogen / curved up / curva hacia arriba
 E: nach unten gebogen / curved down / curva hacia abajo

Mikro Ohrzängchen
Micro Ear Forceps
Micro pinzas auriculares



A
45390-35
0,8 x 3,5 mm



A
45390-50
1 x 5 mm



F
45391-35
0,8 x 3,5 mm



E
45392-35
0,8 x 3,5 mm



C
45393-50
1 x 5 mm



B
45394-50
1 x 5 mm

- A: gerade / straight / recta
B: rechts / right / derecha
C: links / left / izquierda
E: nach unten gebogen / curved down / curva hacia abajo
F: nach oben gebogen / curved upwards / curva hacia arriba

Mikro Ohrzängchen
Micro Ear Forceps
Micro pinzas auriculares

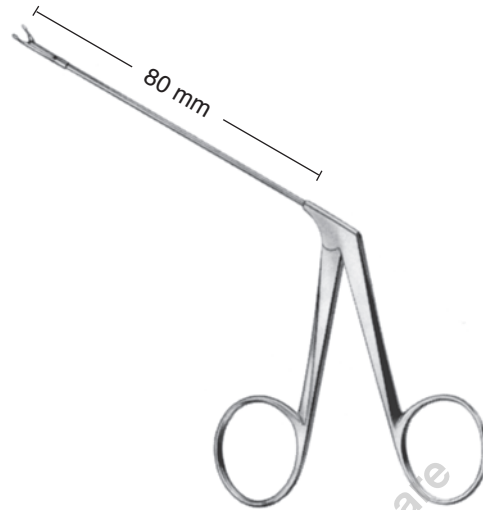

WULLSTEIN



A
45400-01
0,9 x 1 mm

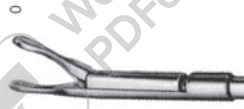

A
45400-02
0,8 x 1,3 mm



A
45400-03
1 mm



A
45401-25
1,7 x 2,5 mm

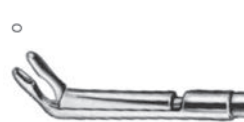

D
45402-10
0,9 x 1 mm



C
45403-13
0,8 x 1,3 mm



B
45404-13
0,8 x 1,3 mm

A: gerade / straight / recta
B: rechts / right / derecha
C: links / left / izquierda
D: aufgebogen / curved up / curva hacia arriba

Mikro Ohrscheren
Micro Ear Scissors
Micro tijeras auriculares

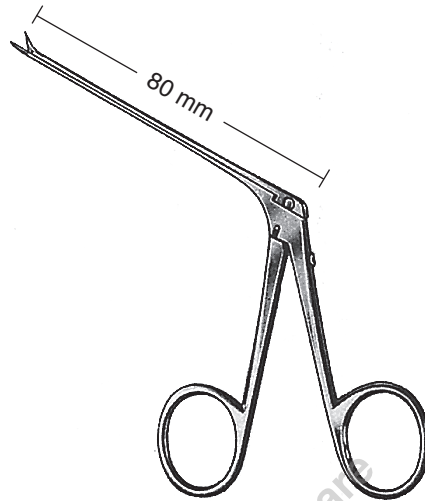

A
BELLUCCI
45300-30
3 mm
extra zart
very delicate
muy fina



A
BELLUCCI
45310-40
micro mini
4 mm



A
BELLUCCI
45312-55
micro standard
5,5 mm

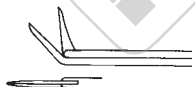

D
BELLUCCI
45313-55
micro standard
5,5 mm

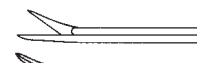

B
BELLUCCI
45315-55
micro standard
5,5 mm

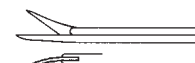

C
BELLUCCI
45317-55
micro standard
5,5 mm



A
SHEA
45320-70
7,0 mm

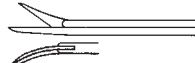

C
SHEA
45321-70
7,0 mm

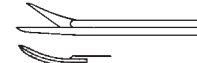

B
SHEA
45322-70
7,0 mm

- A: gerade / straight / recta
- B: rechts / right / derecha
- C: links / left / izquierda
- D: aufgebogen / curved up / curva hacia arriba
- E: nach unten gebogen / curved down / curva hacia abajo

Drahtbiegezängchen, Faßzängchen
Wire Bending Forceps, Grasping Forceps
Pinzas plegadoreas del alambre, Pinza prensora



McGEE
45371-40
0,8 x 4,0 mm

GREVEN
45370-50
0,8 x 5,0 mm

SCHUKNECHT
45372-60
0,8 x 6,0 mm

Mikro Ohrscheren
Micro Ear Scissors
Micro tijeras auriculares



FISCH



B
FISCH
45324-03
3,0 mm



C
FISCH
45325-03
3,0 mm

B: rechts / right / derecha
C: links / left / izquierda

Mikro Ohrscheren
Micro Ear Scissors
Micro tijeras auriculares

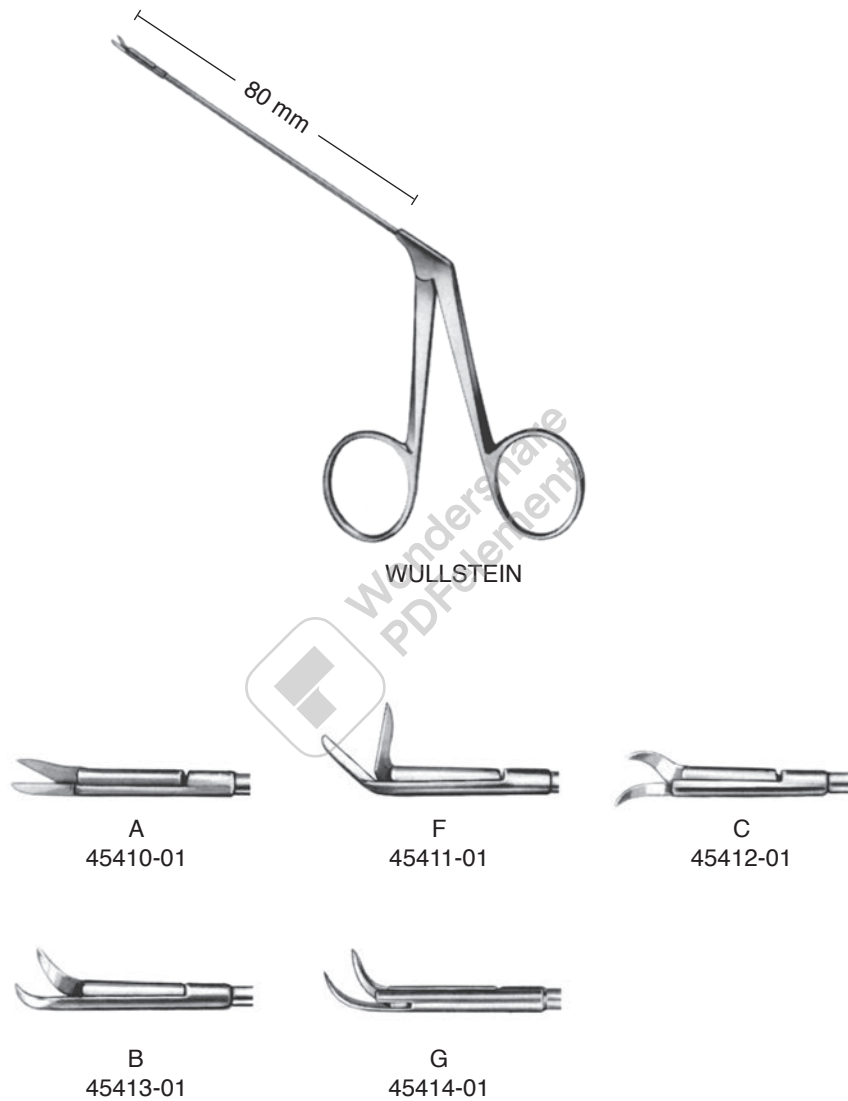

- A: gerade / straight / recta
B: rechts / right / derecha
C: links / left / izquierda
F: nach oben gebogen / curved upwards / curva hacia arriba
G: horizontal schneidend / horizontal cutting / corte horizontal

Hammerkopfstanze
Malleus Punch
Pinza para cabeza del martillo

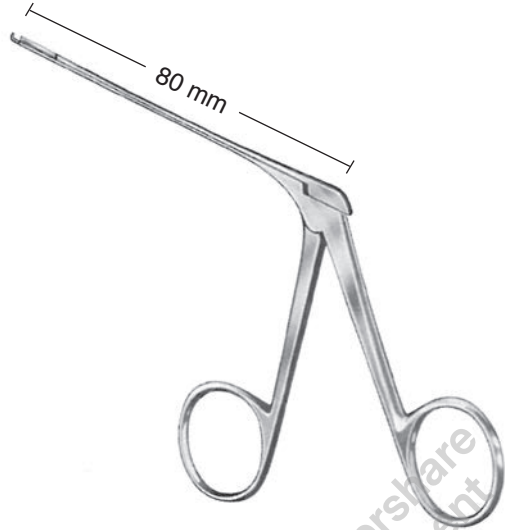

DIETER

micro ø 1,3 mm



45385-01

aufwärts
upward
arriba

mini ø 1,8 mm

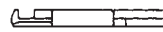

45387-01



45385-02

abwärts
downward
abajo

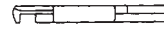

45387-02

Biegegerät, Quetschzange
Bending Device, Pressure Forceps
Dispositivo para modelar, Pinza para aplastar



SCHUKNECHT
45430-00

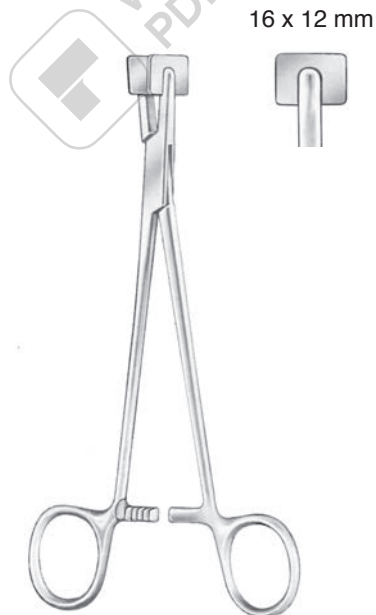

HOUSE-GELFOAM
45440-19
19 cm, 7 □"

Elevatoren, Raspatorien
Elevators, Raspatories
Elevadores, Periostótomos

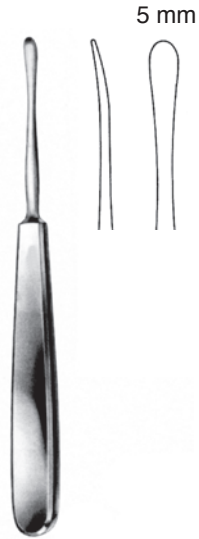

SEBILEAU
33707-17
17,5 cm, 7"



QUERVAIN
33708-19
19,5 cm, 7 1/4"



LANGENBECK
33710-19
19 cm, 7 1/2"

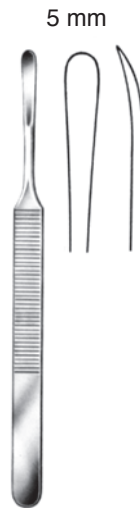

KÖNIG
33714-15
15,5 cm, 6"

Raspatorien
Raspatories
Periostótomos

4 mm



WILLIGER
33711-16
16 cm, 6 □"

6,5 mm



WILLIGER
33712-16
16 cm, 6 □"

5 mm



WILLIGER
33713-16
16 cm, 6 □"

5,5 mm



WILLIGER
33713-17
17 cm, 6 □"

Raspatorien, Elevatoren
Raspatories, Elevators
Periostótomos, Elevadores

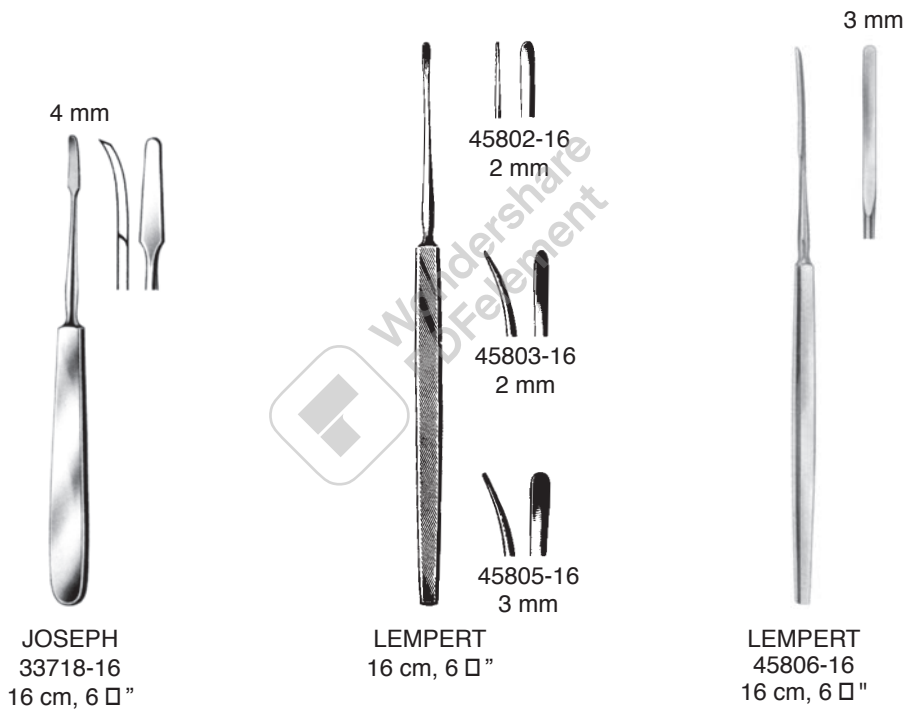

Raspatorien
Raspatories
Periostótomos

mit Ferrozellgriff
with Ferrozell-Handle
con mango de Ferrozell

6 mm



33740-19
19 cm, 7 □"

3 mm



33741-18
18,5 cm, 7 □"

6 mm



33742-18
18,5 cm, 7 □"

6 mm



33743-18
18,5 cm, 7 □"

Raspatorien
Raspatories
Periostótomos



Raspatorien, Elevatoren
Raspatories, Elevators
Periostótomos, Elevadores

6 mm



LEMPERT
45807-20
20,5 cm, 8"

15 mm

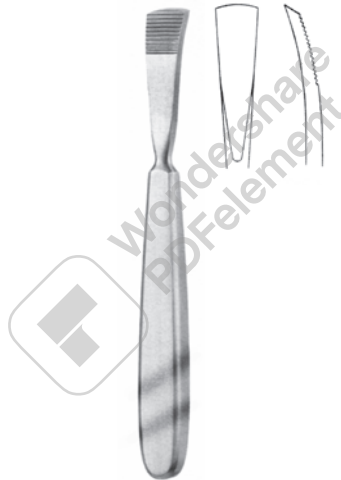

JANSEN
33701-16
16,5 cm, 6 1/2"

4,5 mm

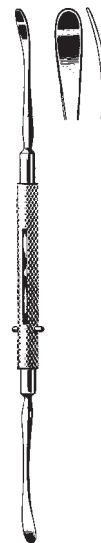

FREER
47415-18
18 cm, 7"

Elevatoren, Raspatorien
Elevators, Raspatories
Elevadores, Periostótomos

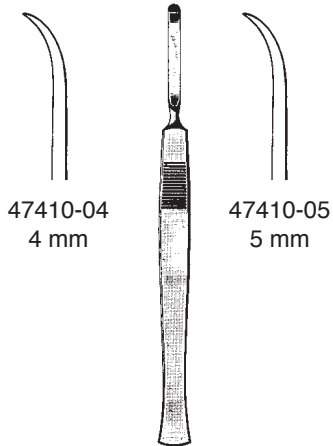

McKENTY
15 cm, 6"



MOLT
33716-18
18 cm, 7"



MILLER
17 cm, 6 1/2"



WULLSTEIN
45806-17
17 cm, 6 1/2"

Dissektor, Raspatorien
Excavator, Raspatories
Disector, Periostótomos

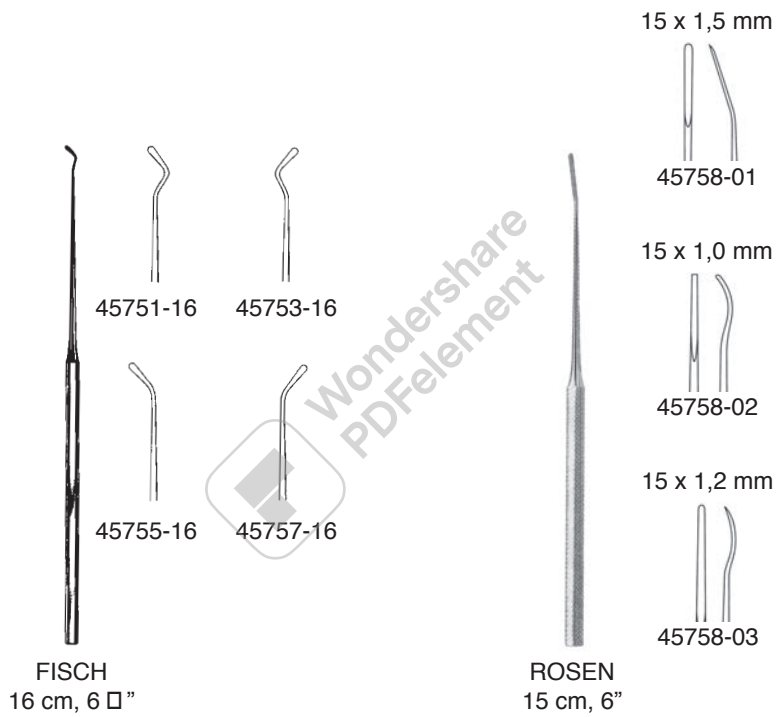

Ohrpinzetten
Ear Forceps
Pinzas auriculares

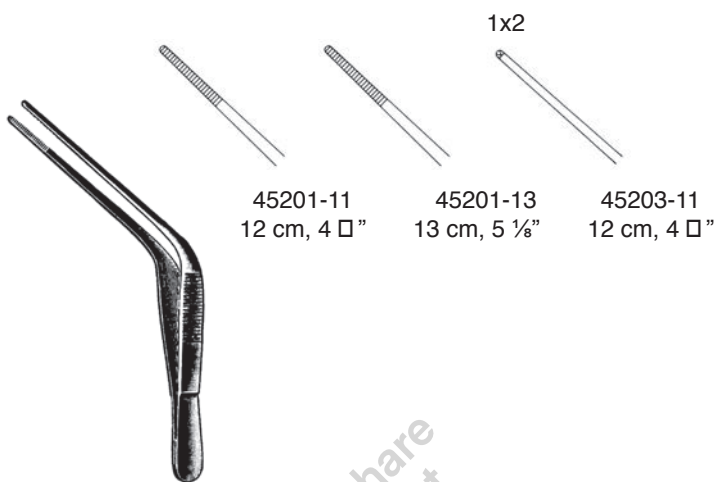

WILDE (TROELTSCH)

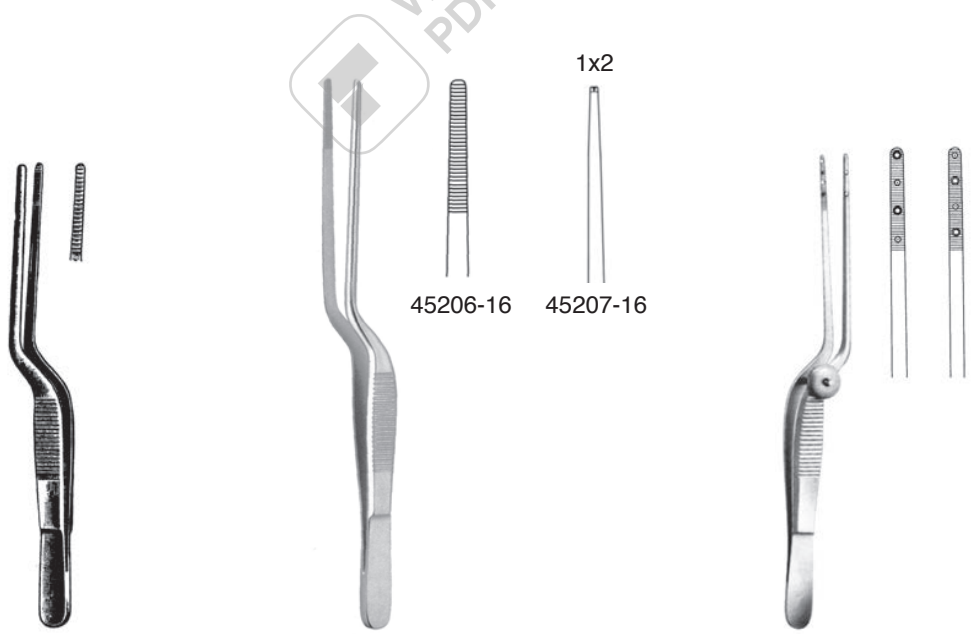

LUCAE
45206-14
14 cm, 5 □"

LUCAE
45207-16
16 cm, 6 □"

COTTLE
45208-14
14 cm, 5 □"

Anatomische und chirurgische Pinzetten
Dressing and Tissue Forceps
Pinzas de disección, sin/con dientes



STANDARD
11120-11
11,5 cm 4 □"



GRAEFE
11190-10
10,5 cm, 4.1"



SEMKEN
11260-12 12,5 cm, 5"
11260-15 15,5 cm, 6"



SEMKEN
11270-12 12,5 cm, 5"
11270-15 15,5 cm, 6"

Uhrmacherpinzetten
Jeweler Type Forceps
Pinzas de relojero

Fig. 1



11401-01
12 cm, 4 1/4"

Fig. 3



11403-03
12 cm, 4 1/4"

Fig. 3c



11403-04
11 cm, 4 3/8"

Fig. 4



11404-04
11 cm, 4 3/8"

Fig. 5



11405-05
11 cm, 4 3/8"

Fig. 7



11407-07
12 cm, 4 1/4"

Ohrpinzetten
Ear Forceps
Pinzas auriculares



ADSON
11170-12 12,0 cm, 4 □“
11170-15 15,0 cm, 6“



ADSON
11180-12 12,0 cm, 4 □“
11180-15 15,0 cm, 6“



DERLACKI
45209-12
12 cm, 4 □”

Flachmeißel, Hohlmeißel, Stößel
Chisels, Gouges, Tampers
Cinceles, Gubias, Hemostático

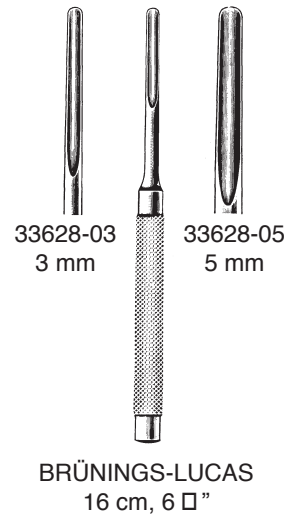
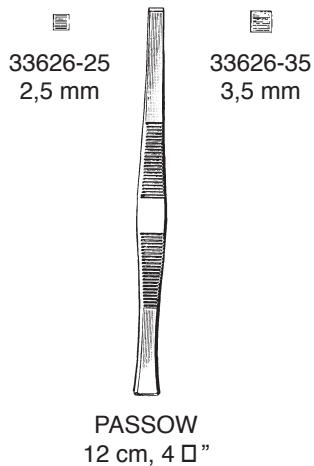
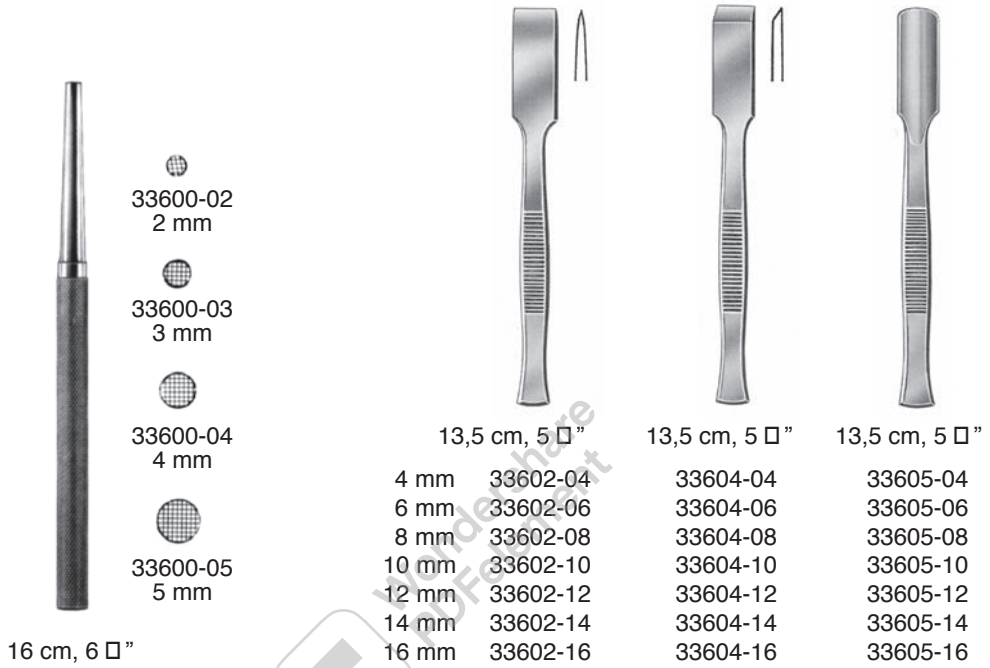

Flachmeißel, Hohlmeißel, Osteotome
Chisels, Gouges, Osteotome
Cinceles, Gubias, Osteótomo



PARTSCH

13,5 cm, 5 □"

33620-02	2 mm
33620-03	3 mm
33620-04	4 mm
33620-05	5 mm
33620-06	6 mm

PARTSCH

13,5 cm, 5 □"

33623-02	2 mm
33623-03	3 mm
33623-04	4 mm
33623-05	5 mm
33623-06	6 mm



2 mm



3 mm



4 mm



6 mm



8 mm



10 mm



12 mm



15 mm

12,5 cm, 5"	mm	17 cm, 6 □"
33654-02	2	33652-02
33654-03	3	33652-03
33654-04	4	33652-04
33654-06	6	33652-06
33654-08	8	33652-08
33654-10	10	33652-10
33654-12	12	33652-12
33654-15	15	33652-15

MINI-LAMBOTTE

Flachmeißel und Hohlmeißel mit Ferrozellgriff, Osteotome
Chisels and Gouges with Ferrozell-Handle, Osteotome
Cinceles, Gubias con mango de Ferrozell, Osteótomo

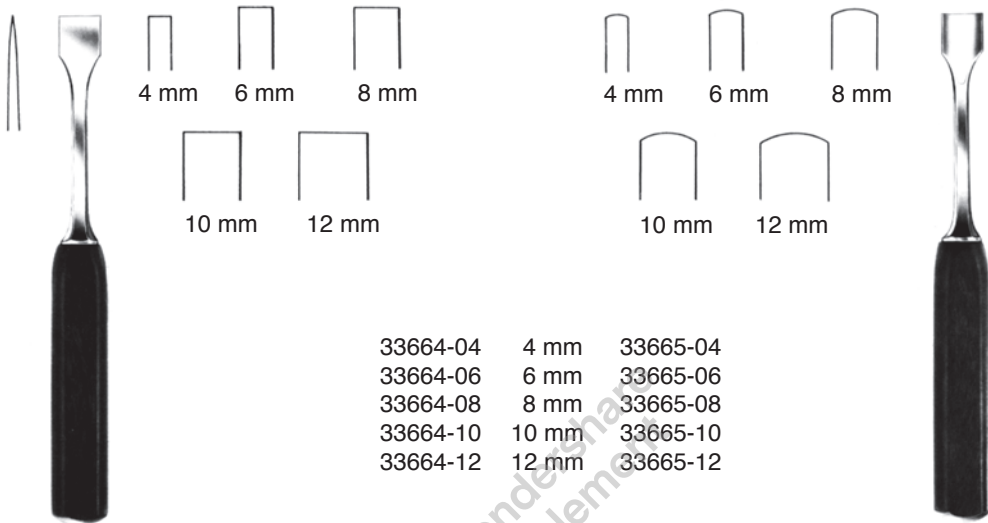

LEXER MINI
18 cm, 7"

LEXER MINI
18 cm, 7"

33664-04	4 mm	33665-04
33664-06	6 mm	33665-06
33664-08	8 mm	33665-08
33664-10	10 mm	33665-10
33664-12	12 mm	33665-12



FREER
47450-04
15 cm, 6"



FREER
47451-04
15 cm, 6"

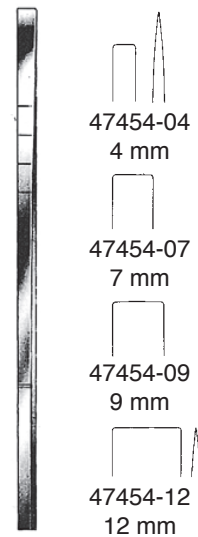

COTTLE
18 cm, 7"

Septum Osteotom
Rhinoplastic Osteotome
Osteotomo para rinoplastia

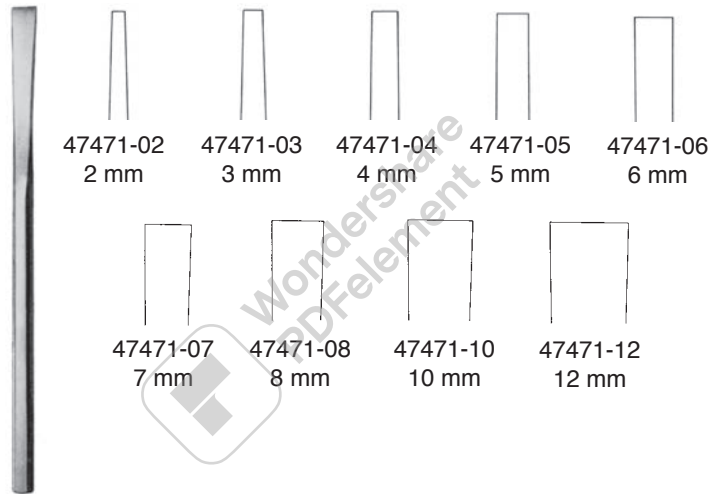

SHEEHAN
16 cm, 6 □"

Hämmer
Mallets
Martillos

massiv, mit auswechselbaren Ferrozellbacken
solid, with interchangeable Ferrozell jaws
macizo, con tapas intercambiables de Ferrozell

Ø 20 mm



MEAD
17 cm, 6 1/4"
33693-32 320 g

Ø 25 mm



135 g
33694-01 18,5 cm, 7 1/4"
33694-03 Ersatzbacken
Nylon Caps
Tapas de repuesto

Ø 22 mm



PARTSCH
33698-98
18 cm, 7"
199 g

Ø 30 mm



COTTLE
18 cm, 7" 240 g
33700-05

Ø 27 mm



HAJEK
21 cm, 8 1/4" 140 g
33700-08

Scharfe Löffel
Bone Currettes
Cucharillas cortantes

Fig.	SPRATT
0000	33474-96
000	33474-97
00	33474-98
0	33475-00
1	33475-01
2	33475-02
3	33475-03
4	33475-04
5	33475-05
6	33475-06

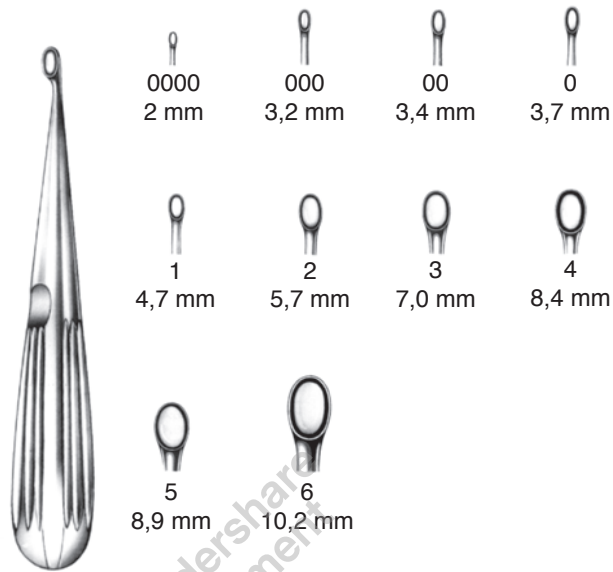

SPRATT
17 cm, 6 □"



LEMPERT
17,5 cm, 7"



Fig.	0	33490-10	3,3 mm
	00	33490-20	3,0 mm
	000	33490-30	2,7 mm
	0000	33490-40	2,4 mm
	00000	33490-50	2,0 mm



JANSEN
33495-16 16 cm, 6 □"



Scharfe Löffel
Bone Currettes
Cucharillas cortantes



BARTH
33393-18, 18 cm, 7"



HALLE
21 cm, 8 1/4"

Fig.
1 33476-01 4,8 mm
2 33476-02 5,8 mm
3 33476-03 6,8 mm

biegsam
malleable
maleable



VOLKMANN
17 cm, 6 1/4"

Fig. VOLKMANN
0000 33469-96
000 33469-97
00 33469-98
0 33470-00
1 33470-01
2 33470-02
3 33470-03
4 33470-04
5 33470-05
6 33470-06

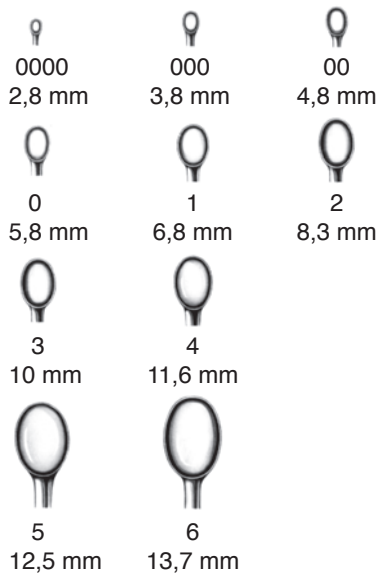

Scharfe Löffel
Bone Currettes
Cucharillas cortantes

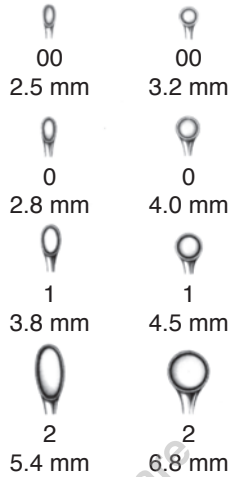

WILLIGER 17,5 cm, 7"	Fig.	00	33485-99	33486-99
		0	33486-00	33487-00
		1	33486-01	33487-01
		2	33486-02	33487-02

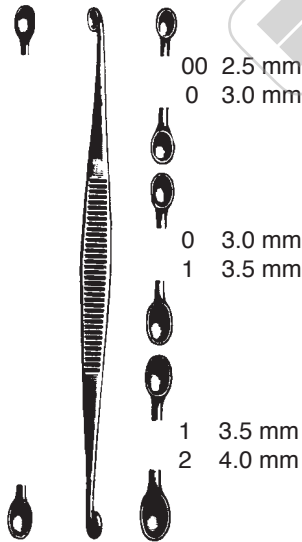

WILLIGER	
13,5 cm, 5 1/2"	Fig.
33496-00	00/0
33496-01	0/1
33496-12	1/2

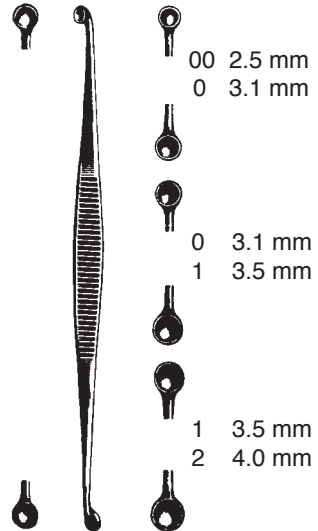

MARTINI	
13,5 cm, 5 1/2"	Fig.
33498-00	00/0
33498-01	0/1
33498-12	1/2

Hohlmeißelzangen
Bone Rongeurs
Pinzas-gubias

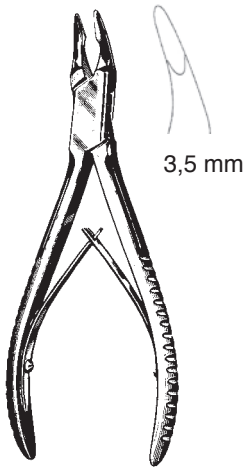

BLUMENTHAL
33115-15
15,5 cm, 6"

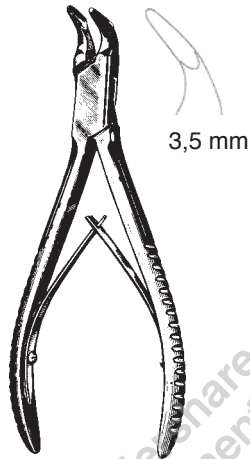

BLUMENTHAL
33117-15
15,5 cm, 6"

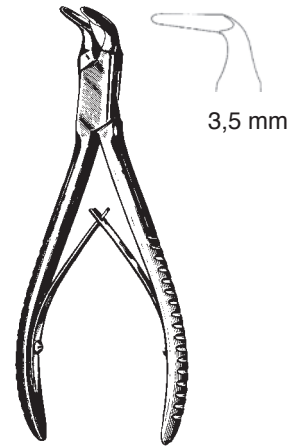

BLUMENTHAL
33119-15
15,5 cm, 6"



LUER
33131-15
15 cm, 5.9"

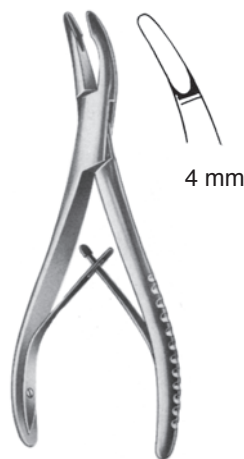

LUER
33133-15
15 cm, 5.9"



BANE-HARTMANN
33148-18
17,5 cm, 7"

Hohlmeißelzangen
Bone Rongeurs
Pinzas-gubias



— LEMPERT —
33150-16 33151-16
16 cm, 6 1/2"



BEYER
33156-18
18 cm, 7"

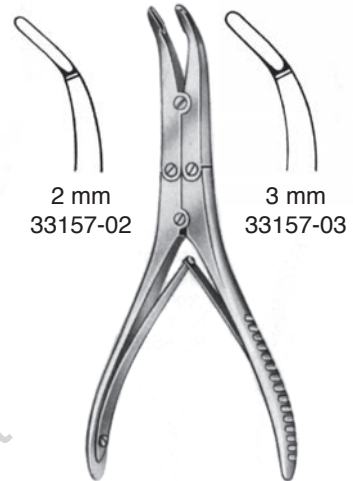

KLEINERT-KUTZ
15 cm, 6"



BEYER
33201-18
18 cm, 7"



ZAUFAL-JANSEN
33205-18
18 cm, 7"



— BÖHLER —
33211-15 33213-15
15 cm, 6"

Knochensplitterzangen
Bone Cutting Forceps
Pinzas cortantes para huesos



— BÖHLER —
33280-15 33281-15
15 cm, 6"



COTTLE-KAZANJIAN
33282-19
19 cm, 7 1/2"



MC INDOE
33283-17
17 cm, 6 1/2"

Knochenstanzen
Bone Punches
Pinzas sacabocado

**KERRISON**

3x3 mm 47303-03
4x4 mm 47303-04
5x5 mm 47303-05
6x6 mm 47303-06
17 cm, 6 1/2"

**CITELLI**

47311-10 1,0 mm
47311-25 2,5 mm
47311-30 3,0 mm

Wundsperrer
Retractors
Separadores

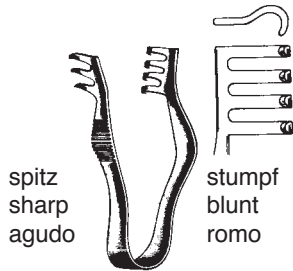

FINSSEN
19610-07 7 cm, 2 □“ 19611-07

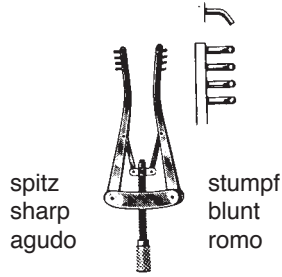

ALM
19620-07 7 cm, 2 □“ 19621-07
19620-10 10 cm, 4“ 19621-10

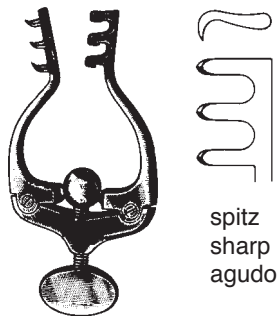

JANSSEN
19630-10
10 cm, 4“

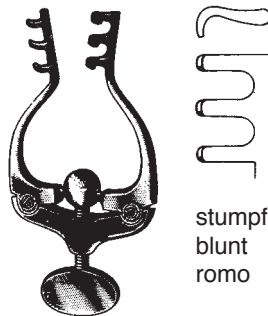

JANSSEN
19631-10
10 cm, 4“

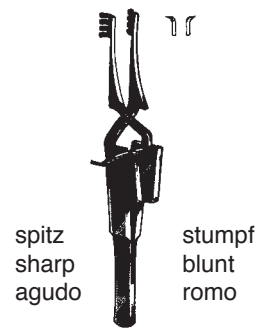

HOLZHEIMER
19634-10 19635-10
10 cm, 4“

Wundsperrer
Retractors
Separadores

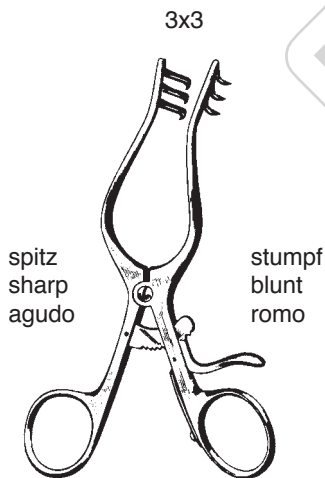
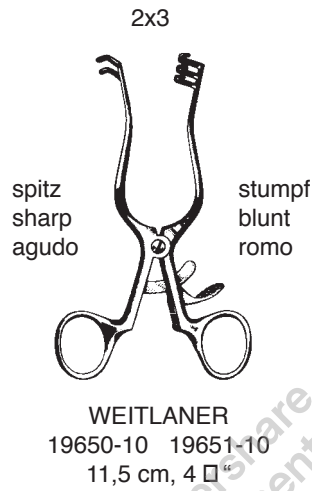

WEITLANER-WULLSTEIN
19654-13 19655-13
13 cm, 5 1/8 "

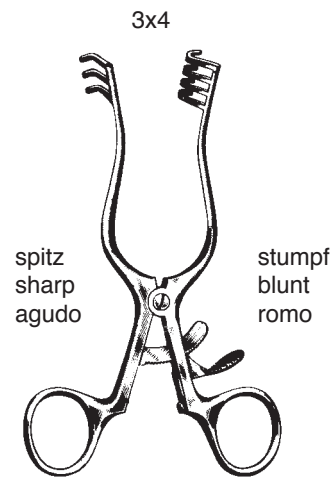

WEITLANER
19670-14 14,0 cm, 5 □ " 19671-14
19670-16 16,5 cm, 6 □ " 19671-16

Wundsperrer
Retractors
Separadores

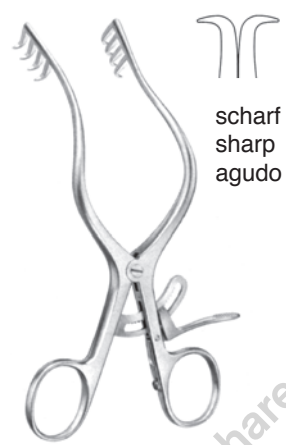

MOLLISON
19674-15
15 cm, 6"



FISCH
19683-17
17 cm, 6 1/2"

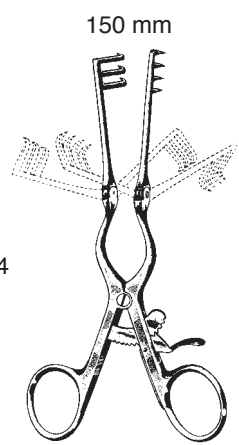

19684-14
spitz
sharp
agudo

19685-14
stumpf
blunt
romo

ADSON
14 cm, 5 1/2"

Wundsperrer
Retractors
Separadores

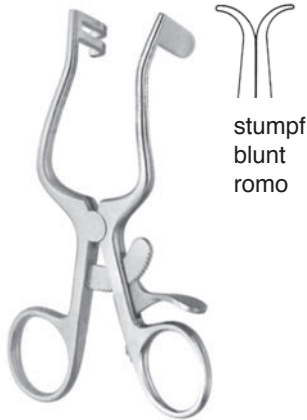

stumpf
blunt
romo

PLESTER
19672-11
11 cm, 4 3/8"

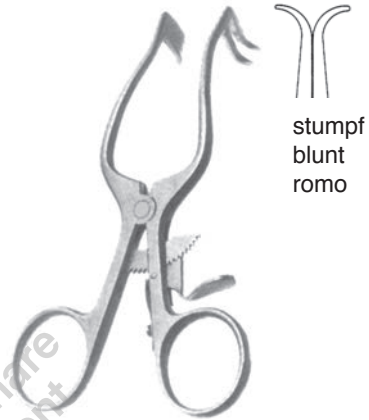

stumpf
blunt
romo

PLESTER
19673-11
11 cm, 4 3/8"

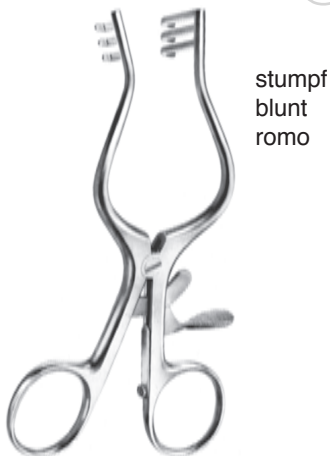

stumpf
blunt
romo

WULLSTEIN
19675-13
13 cm, 5 1/4"

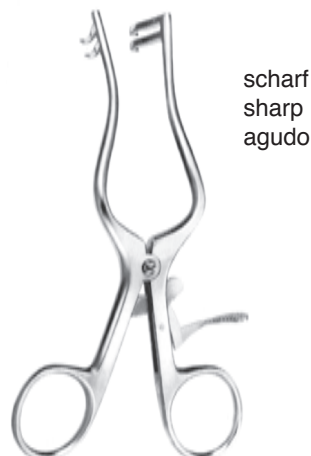

scharf
sharp
agudo

PLESTER
19677-10 10 cm, 4"
19677-13 13 cm, 5 1/8"

Wundhaken
Retractors
Separadores



19283-01

gerade
straight
recto

WILLIGER
12 cm, 4 1/4"



19283-02

links gebogen
left curved
curvado hacia la izquierda



19283-03

rechts gebogen
right curved
curvado hacia la derecha

Präparierscheren
Dissecting Scissors
Tijeras de disección



METZENBAUM
09280-15 **09284-15 TC**
15 cm 6"



METZENBAUM
09281-15 **09285-15 TC**
15 cm 6"



METZENBAUM FINO
09282-15 **09286-15 TC**
15 cm 6"



METZENBAUM FINO
09283-15 **09287-15 TC**
15 cm 6"

Präparierscheren
Dissecting Scissors
Tijeras de disección



— JOSEPH —
09304-14 14 cm 09305-14
5 □"



— STRABISMUS —
09370-11 09371-11
09374-11 TC 09375-11 TC
11 cm, 4 3/8"



GORNEY
10050-12
12,5 cm, 5"

Chirurgische Scheren
Operating Scissors
Tijeras para cirugía



STANDARD

09110-11 11,5 cm, 4 1/4"
09110-13 13,0 cm, 5"
09110-14 14,5 cm, 5 1/4"



STANDARD

09111-11 11,5 cm, 4 1/4"
09111-13 13,0 cm, 5"
09111-14 14,5 cm, 5 1/4"

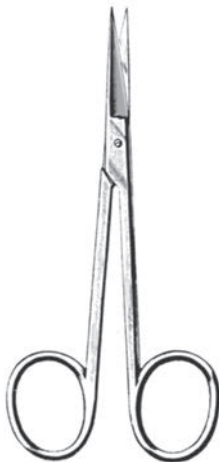

IRIS

11 cm, 4 3/8"



09340-11
09344-11 TC

gerade
straight
rectas



09341-11
09345-11 TC

gebogen
curved
curvas

Draht-, Blehschere
Wire and Plate Scissors
Tijeras para alambre y láminas

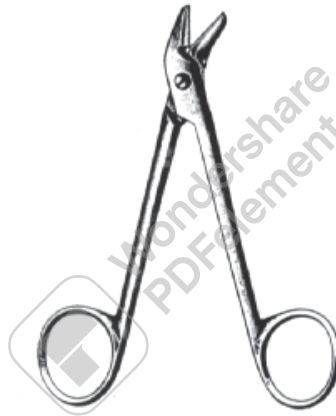
**UNIVERSAL**

09831-12 12 cm, 4 □“
09835-12 TC 12 cm, 4 □“

Mikro Scheren
Micro Scissors
Micro-Tijeras

10 mm



10202-14 14,5 cm, 5 1/4" 10203-14

Messer
Knives
Cuchillos

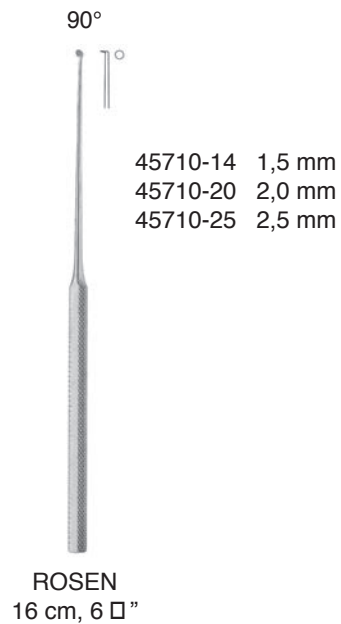
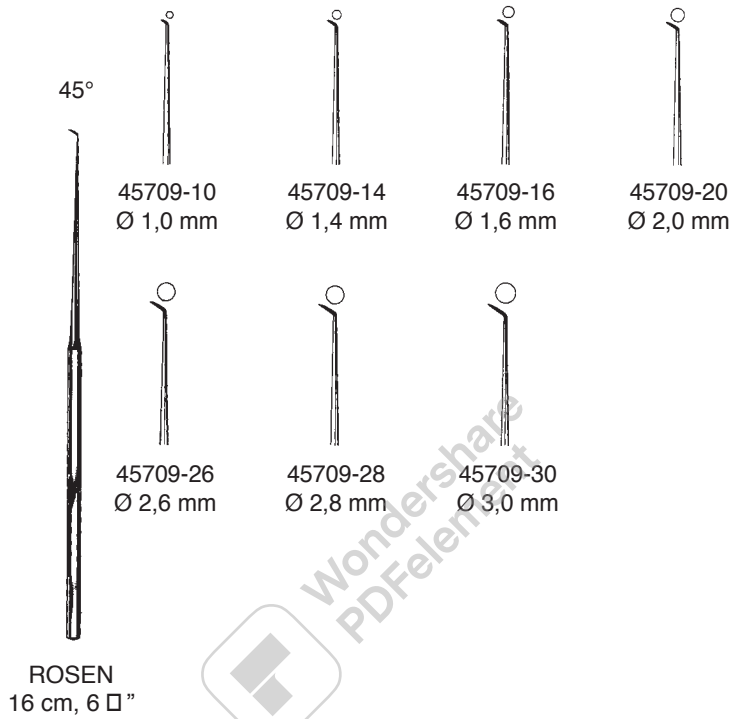

Messer
Knives
Cuchillos

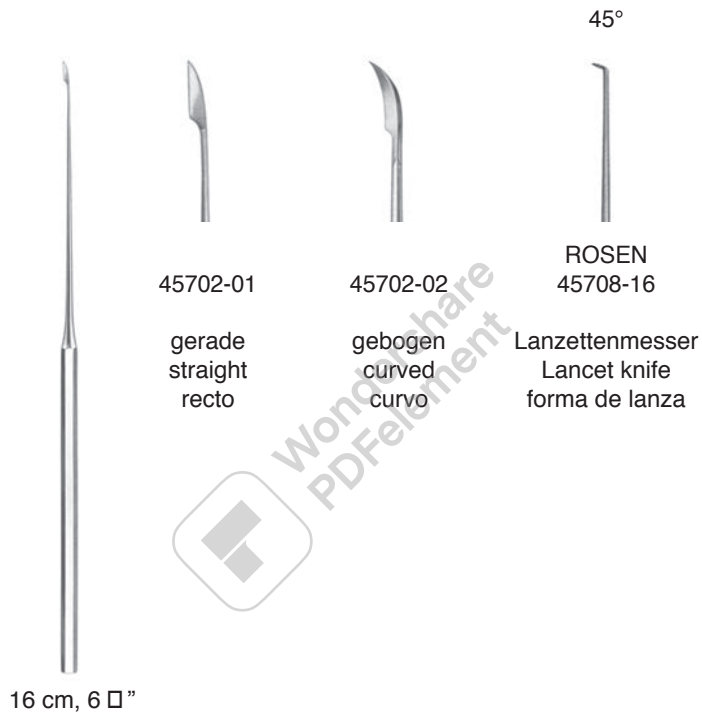

Messer
Knives
Cuchillos



SCHUKNECHT
45701-01
16 cm, 6 1/2"



SCHUKNECHT
45701-02
16 cm, 6 1/2"



SCHUKNECHT
45703-15
15,5 cm, 6"



WULLSTEIN
45704-15
15,5 cm, 6"



TABB
45705-15
15,5 cm, 6"



PLESTER
45706-35
15,5 cm, 6"





Mikro Nadelhalter
Micro Needle Holders
Micro-porta-agujas



BARRAQUER

ohne Sperre
without lock
sin cremallera

mit Sperre
with lock
con cremallera

				
11,5 cm, 4 1/8"	25660-12	25661-12	25720-12	25731-12
13,0 cm, 5 1/8"	25660-13	25661-13	25720-13	25731-13
14,0 cm, 5 1/2"	25660-14	25661-14	25720-14	25731-14
18,0 cm, 7"	25700-18	25701-18	25730-18	25731-18

mit diamantiertem Maul
with diamond jaw
con boca de diamante

11,5 cm, 4 1/8"		
13,0 cm, 5 1/8"		
14,0 cm, 5 1/2"		
18,0 cm, 7"		
	25720-12D	25671-12D
	25720-13D	25671-13D
	25720-14D	25671-14D
	25730-18D	25731-18D

T= Titan, titanium, titanio

				
15,0 cm, 6"	93250-15T	93251-15T	93260-15T	93261-15T
18,0 cm, 7"	93250-18T	93251-18T	93260-18T	93261-18T

Mikro Nadelhalter mit Sperre
Micro Needle Holders, with Lock
Micro-porta-agujas con cremallera



CASTROVIEJO



14,0 cm, 5 □“
18,0 cm, 7“

25670-14
25670-18

25671-14
25671-18

25672-14
25672-18

25673-14
25673-18

mit TC 1,4 mm
with TC jaw 1,4 mm
con TC 1,4 mm

14,0 cm, 5 □“
18,0 cm, 7“

25674-14
25674-18

25675-14
25675-18

25676-14
25668-18

25677-14
25691-18

mit diamantiertem Maul 0,8 mm
with diamond jaw 0,8 mm
con boca de diamante 0,8 mm

14,0 cm, 5 □“
18,0 cm, 7“

25672-14D
25672-18D

25673-14D
25673-18D

T= Titan, titanium, titanio
Maul / jaw / boca 0,4mm

14,0 cm, 5 □“
18,0 cm, 7“

25672-14T
25672-18T

25673-14T
25673-18T

Saugrohre
Suction Tubes
Tubos de aspiración

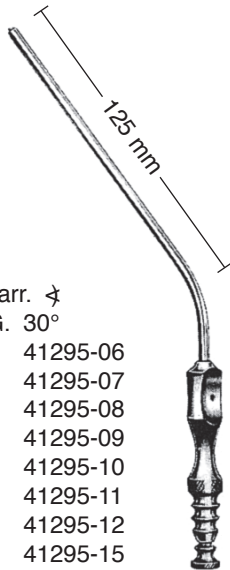

- Charr. ↗
F.G. 30°
- | | |
|----|----------|
| 6 | 41295-06 |
| 7 | 41295-07 |
| 8 | 41295-08 |
| 9 | 41295-09 |
| 10 | 41295-10 |
| 11 | 41295-11 |
| 12 | 41295-12 |
| 15 | 41295-15 |

FRAZIER/FERGUSSON
19 cm, 7 □"

Wondershare
PDFelement



ZÖLLNER
41302-02



- | | |
|----------|----------|
| 0,5 mm Ø | 41306-05 |
| 0,7 mm Ø | 41306-07 |
| 0,9 mm Ø | 41306-09 |
| 1,2 mm Ø | 41306-12 |

Kanüle für Sauggriff
Zöllner und Wullstein

Tip for Suction Handle
Zöllner and Wullstein

Cánula para mango
Zöllner y Wullstein

Saugrohre
Suction Tubes
Tubos de aspiración

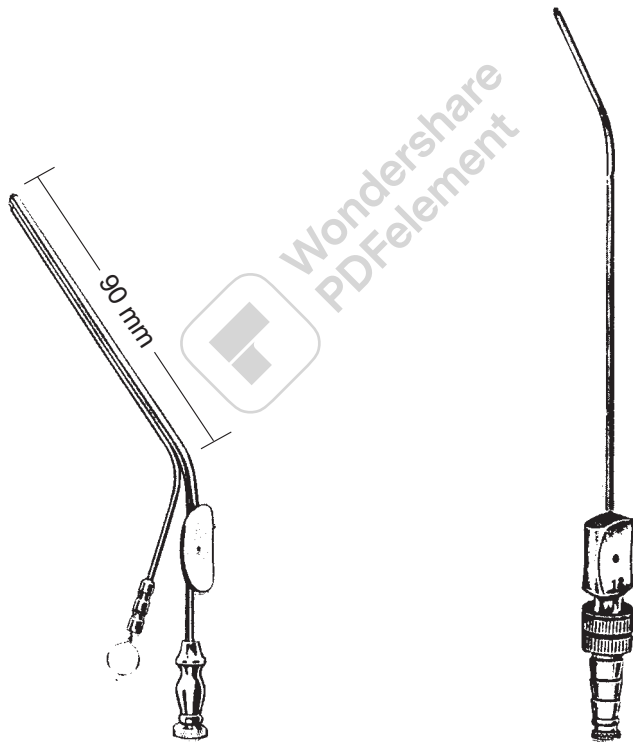
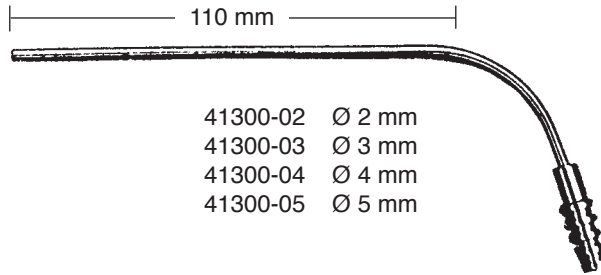

HOUSE
9 cm, 3 1/4"

- | | |
|----------|----------------|
| 41303-09 | Ø 0,9 x 0,7 mm |
| 41303-12 | Ø 1,2 x 0,9 mm |
| 41303-15 | Ø 1,5 x 1,2 mm |
| 41303-18 | Ø 1,8 x 1,8 mm |
| 41303-25 | Ø 2,5 x 2,0 mm |
| 41303-30 | Ø 3,0 x 2,0 mm |
| 41303-45 | Ø 4,5 x 2,0 mm |

PLESTER 30°
Charr. 6 41304-06
Charr. 8 41304-08
Charr. 10 41304-10

Saugrohre
Suction Tubes
Tubos de aspiración

Mikro-Saugkanüle
Micro suction cannula
Micro tubo de aspiración

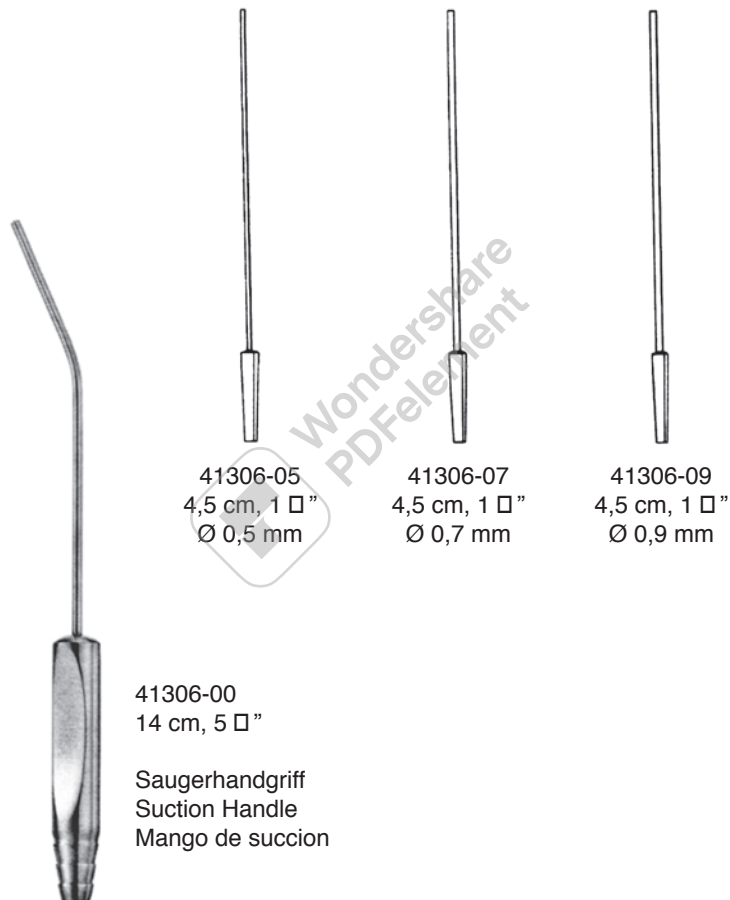

WULLSTEIN
41308-00

komplett, mit Griff und drei Aufsätzen
complete, with handle and 3 tips
completo, con mango y 3 puntas

Saugrohre
Suction Tubes
Tubos de aspiración

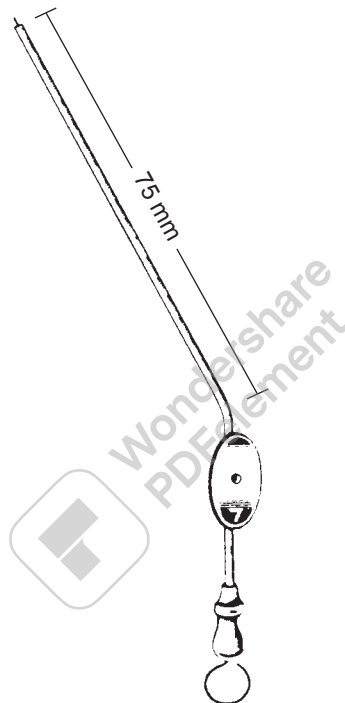

BARON
16 cm, 6 1/4"
41299-03 3FR 1,0 mm
41299-05 5FR 1,6 mm
41299-07 7FR 2,3 mm

Saug- und Spülinstrumente
Aspirating and Irrigation Instruments
Instrumentos de aspiracion y irrigacion

LUER



Sauggriff
Suction Handle
Mango de succion

WULLSTEIN
41307-00

Saugadapter
mit Saugunterbrecher

Suction adapter
with finger cut-off

Adaptador para
aspiración con interrupto

LUER



HOUSE
41300-00
5,5 cm, 2 □"



Kanüle für Sauggriff
Tip for Suction Handle
Cánula para mango de succion

ROSEN
10 cm, 4"

0,5 mm Ø 41305-05	1,2 mm Ø 41305-12
0,6 mm Ø 41305-06	1,5 mm Ø 41305-15
0,7 mm Ø 41305-07	1,8 mm Ø 41305-18
0,8 mm Ø 41305-08	2,0 mm Ø 41305-20
0,9 mm Ø 41305-09	2,5 mm Ø 41305-25
1,0 mm Ø 41305-10	3,0 mm Ø 41305-30

Knorpelzeile
Cartilage Files
Limas para el cartilago

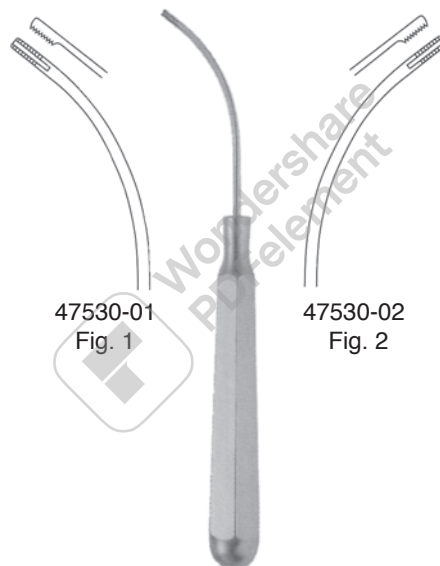

DINGMAN Set
47530-00 15 cm, 6"

Mikro Scheren und Mikro Zangen
Micro Scissors and Forceps
Micro tijeras y pinzas

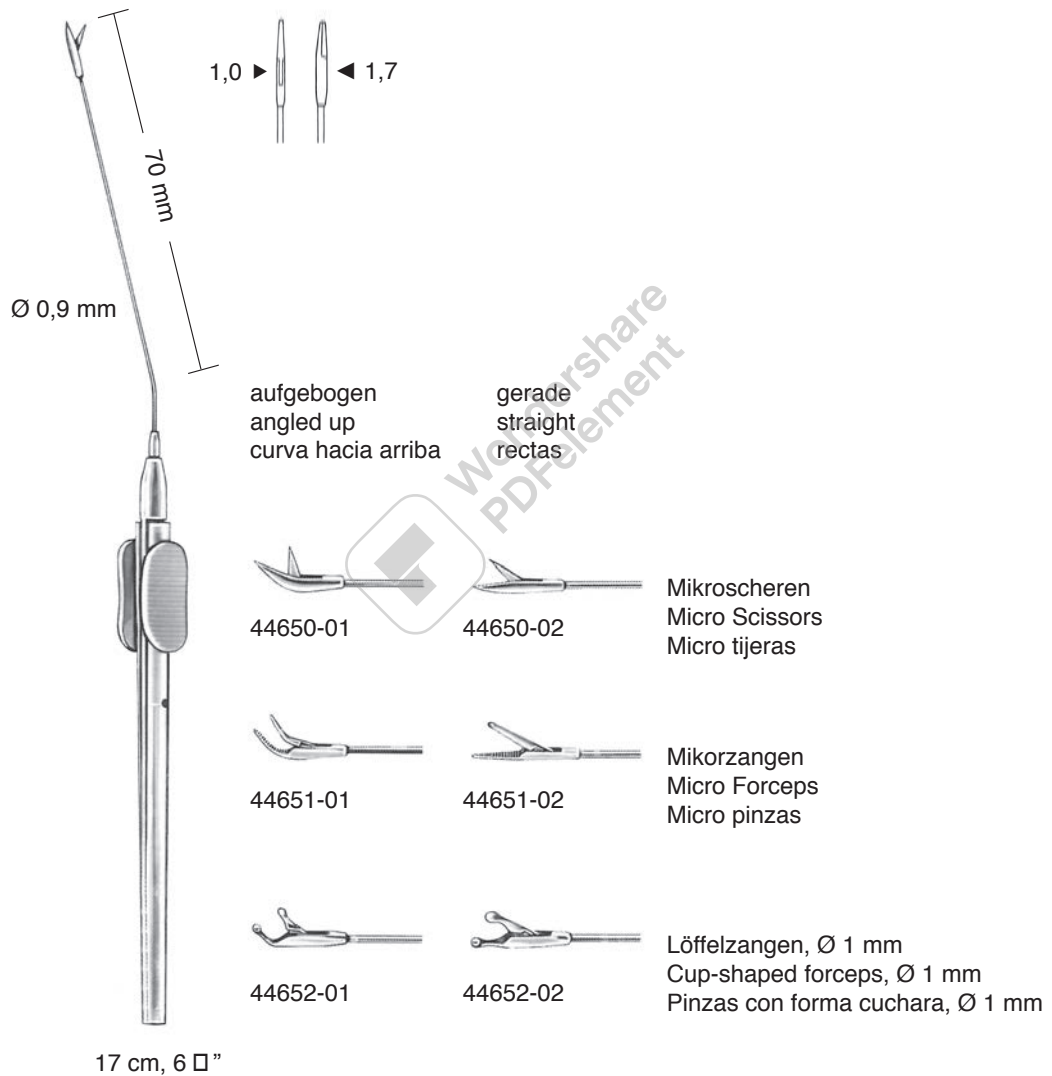



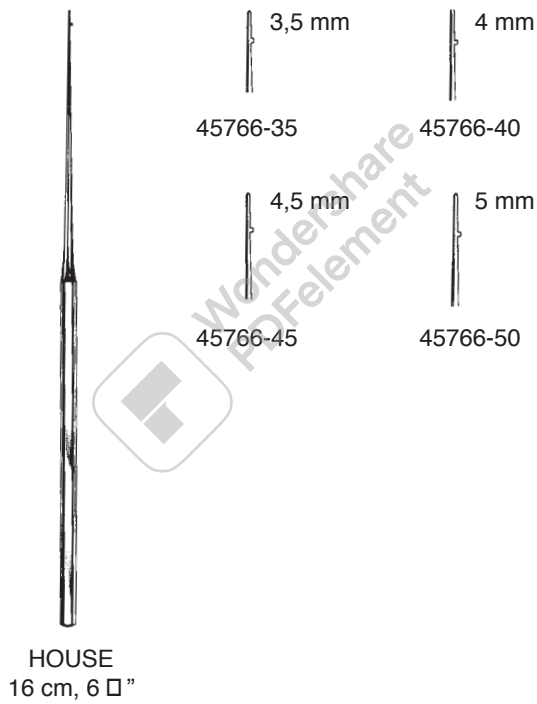

Mikro Meßsonde
Micro Measuring Rod
Sonda para mesurar



Mikro Küretten
Micro Curettes
Micro curetas



mm  
1,0/1,2 45760-01
1,5/1,8 45760-02

mm  
1,0/1,2 45762-01
1,5/1,8 45762-02

HOUSE
15 cm, 6"

Scharfer Löffel
Sharp Spoon
Cucharilla cortante

1,5 x 2,5 mm

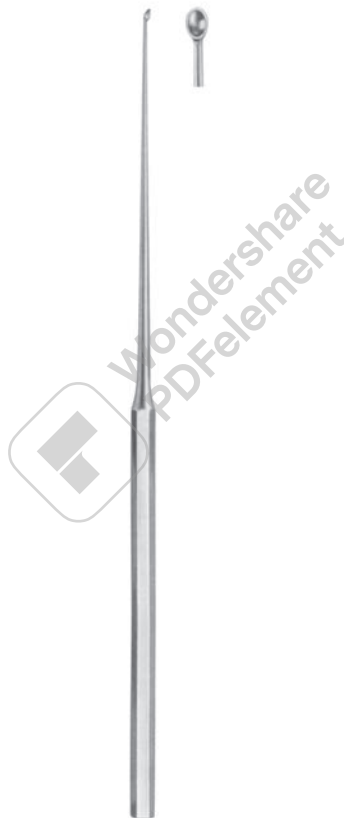

SHEA
45770-01
16 cm, 6 1/4"

Nadeln und Hakchen
Needles and Hooks
Agujas y Ganchos



16 cm, 6 1/4"



BARBARA /
ROSEN
45710-15



stumpf
blunt
roma

BARBARA /
ROSEN
45711-15



BARBARA /
ROSEN
45713-15



BARBARA /
ROSEN
45715-17



25°

SHAMBAUGH
0,3 45720-03
0,6 45720-06
1,0 45720-10



45°

SHAMBAUGH
45722-03
45722-04
45722-06
45722-08
45722-10
45722-12
45722-15
45722-20
45722-25



90°

SHAMBAUGH
45724-03
45724-04
45724-06
45724-08
45724-10
45724-12
45724-15
45724-20
45724-25



BARBARA

45725-05 0,5 mm
45725-10 1,0 mm

Nadeln und Häkchen
Needles and Hooks
Agujas y Ganchos

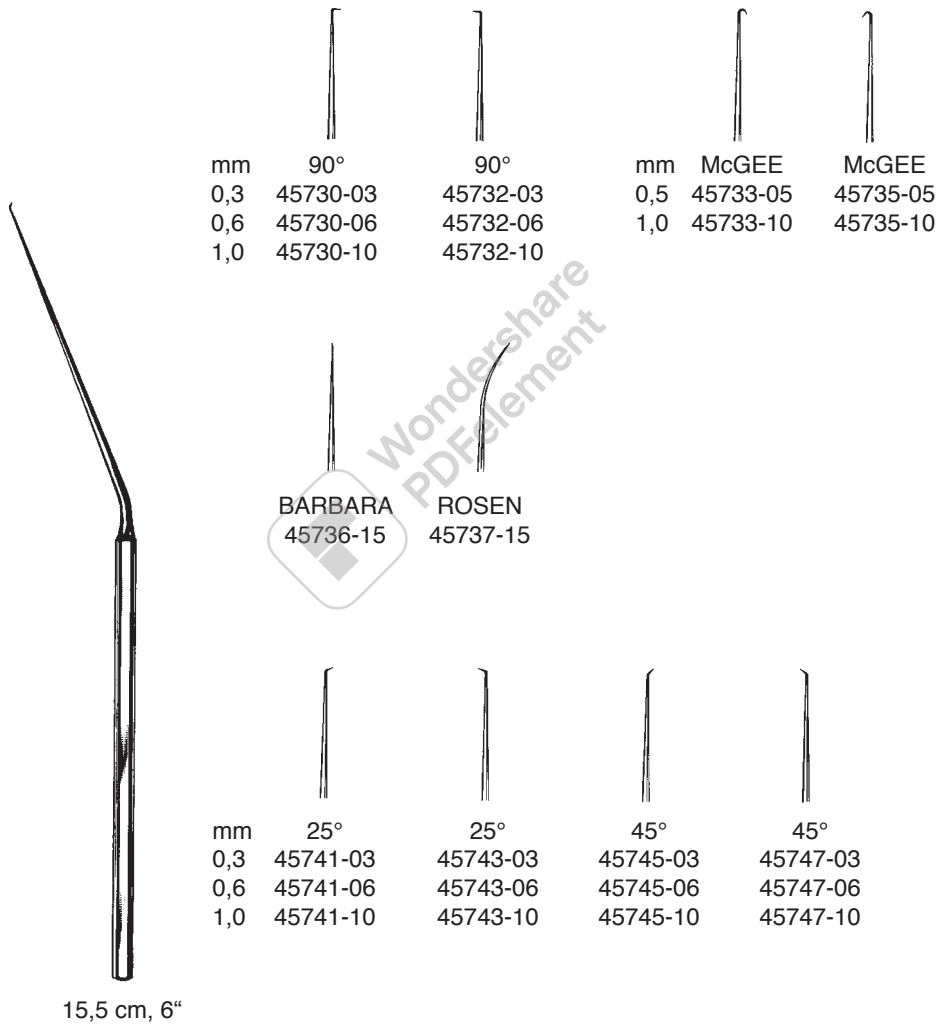

Häkchen
Hooks
Ganchitos



45746-20
abgewinkelt
angled
angulado



45748-16
retrograd schneidend
reverse cutting
ganchito, corte retrogrado

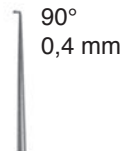

45749-16
abgewinkelt, oval
angled, oval-blunt
angulado, ovalado



45750-16
abgewinkelt, zylindrisch
angled, cylindric
angulado, cilíndrico



45770-16
abgewinkelt, zylindrisch
angled, cylindric
angulado, cilíndrico



45771-16
Führungsgabel
Guide fork
Horquilla de guía



16 cm, 6 □"

Elevatorium, Raspatorium, Löffel
Elevators, Raspatories, Spoon
Elevadores, Periostótomos, Cucharilla

1,0 mm



45756-10
Elevatorium
Elevators
Elevador



45756-20
1,0 mm

45756-30
1,2 mm

Raspatorien
Raspatories
Periostótomos

1,8 mm



45756-50
Raspatorium stark gebogen
Raspatories strongly curved
Periostótomos fuertemente curvado



45756-40
Löffel leicht gebogen
Spoon slightly bent
Cucharilla ligeramente curvada



16,5 cm, 6 □“

RHINOLOGIE
SINUSKOPIE

RHINOLOGY
SINUSCOPY

RINOLOGÍA
SINUSCOPIA



Wondershare
PDFelement

HADEO
INSTRUMENTE GERMANY



Indikationen und Kontraindikationen finden Sie in der entsprechenden Gebrauchsanweisung!
Indication and Contraindication please refer to our user's manual!
Indicaciones y Contraindicaciones se encuentran en la instrucciones de uso correspondientes!

Nasenspekula
Nasal Specula
Espéculos nasales

selbsthaltend
self-retaining
autoestático



THUDICHUM
6,5 cm, 2 □“

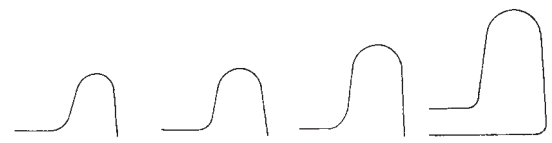

47050-01
Fig. 1

47050-02
Fig. 2

47050-03
Fig. 3

47050-04
Fig. 4

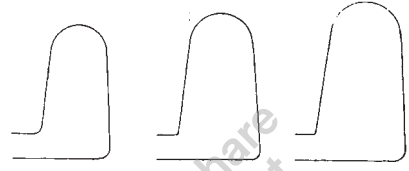

47050-05
Fig. 5

47050-06
Fig. 6

47050-07
Fig. 7



47060-01

47060-02

47060-03

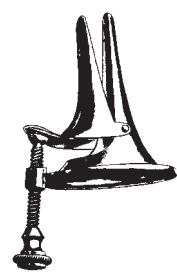

VOLTOLINI

Nasenspekula
Nasal Specula
Espéculos nasales

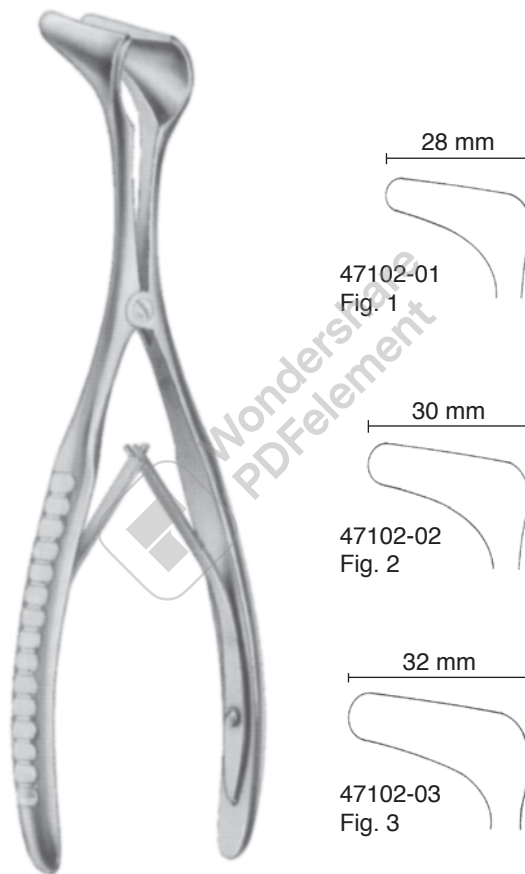

HARTMANN-HALLE
15 cm, 6"

Nasenspekula
Nasal Specula
Espéculos nasales

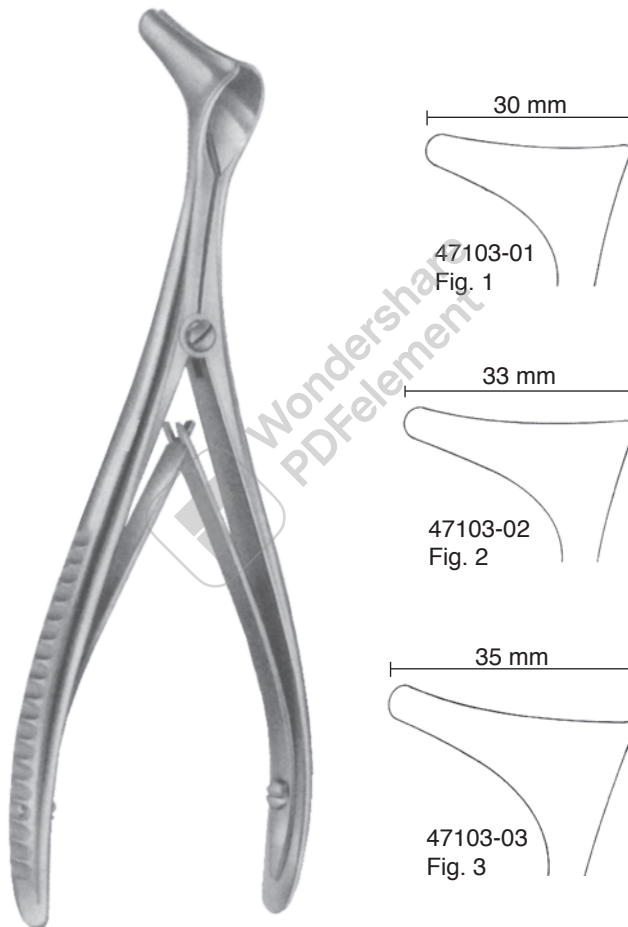

HARTMANN
16 cm, 6 1/4"

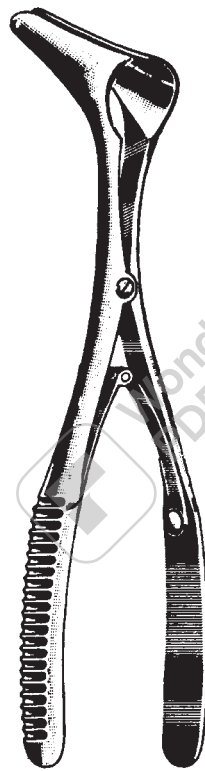
Nasenspekula
Nasal Specula
Espéculos nasalesleichtes Modell
lightweight
modelo ligeroMod. WIEN
14 cm, 5 ″

Baby, bébé	47112-01	25 mm
Kind, child, niño	47112-02	30 mm
Erwachs., adult, adulto	47112-03	35 mm

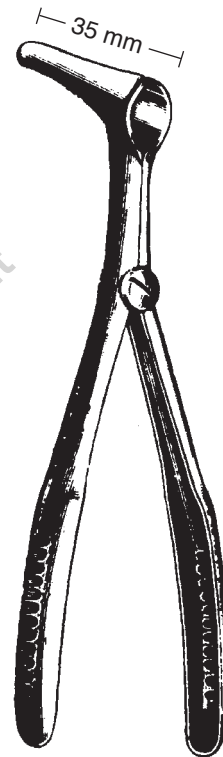
Mod. WIEN
14 cm, 5 ″
47113-03

Nasenspekula
Nasal Specula
Espéculos nasales

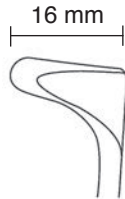

47116-13

für Säuglinge
for babies
para bebés



47116-14

für Kleinkinder
for infants
para niños

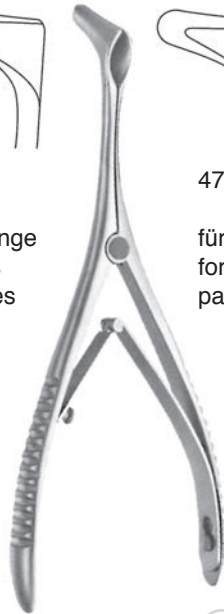

TIECK-HALLE
13,5 cm, 5 1/8"

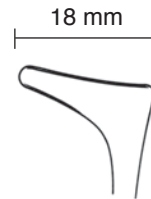

HADEO
47118-13
12,5 cm, 5"



KILLIAN
13 cm, 5 1/8"



47120-35
35 mm

47120-50
50 mm

47120-75
75 mm

47120-90
90 mm

Nasenspekula
Nasal Specula
Espéculos nasales

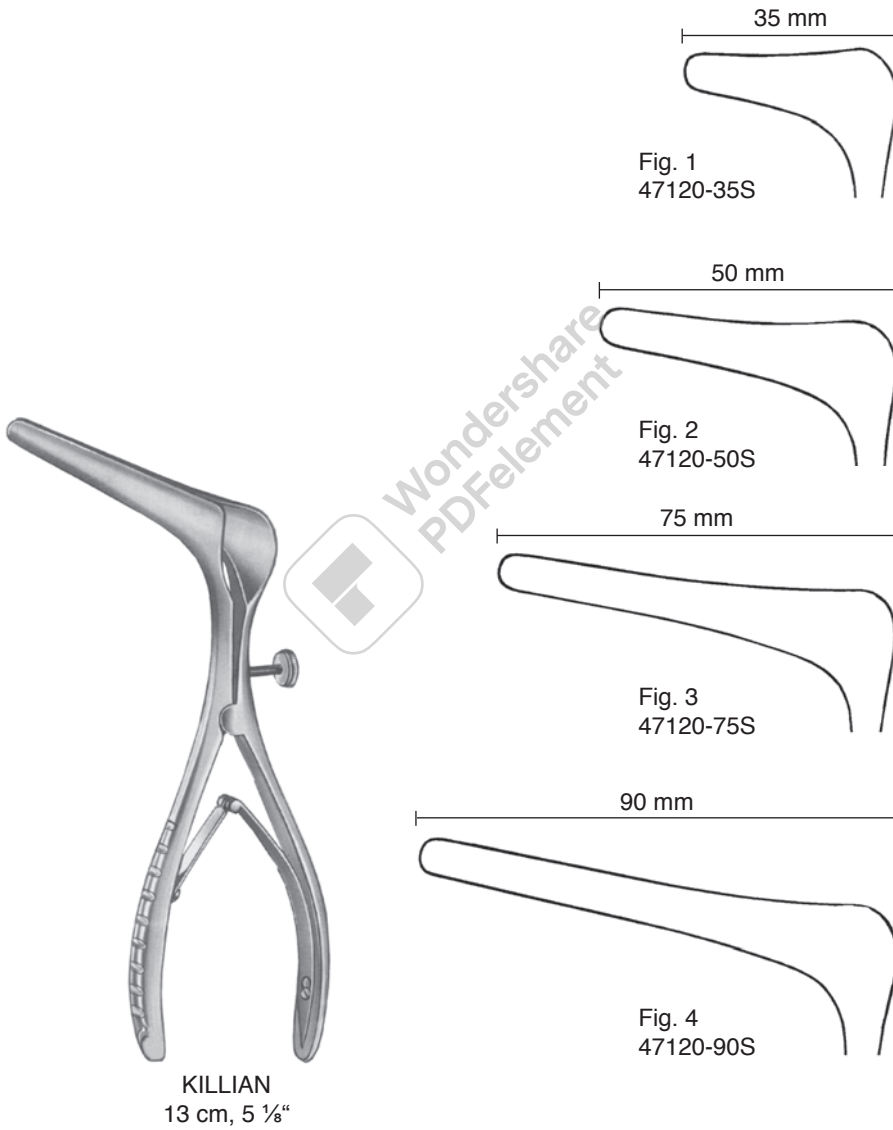

Nasenspekula
Nasal Specula
Espéculos nasales

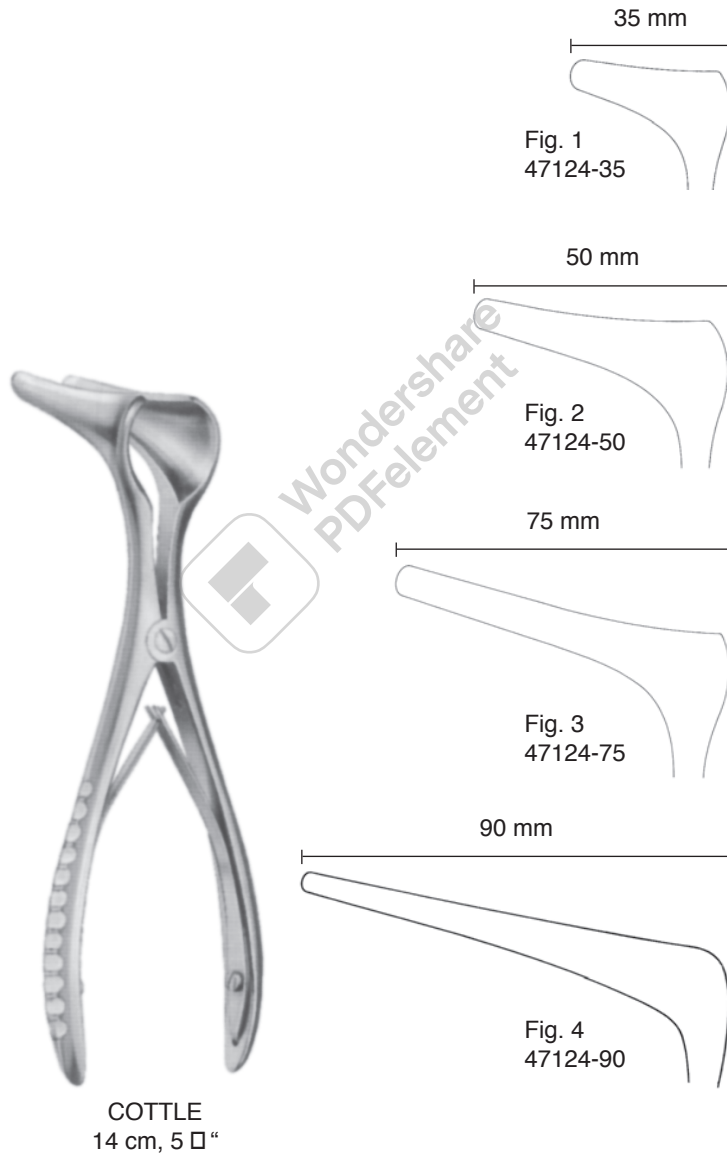

Nasenspekula
Nasal Specula
Espéculos nasales

35 mm

Fig. 1
47124-35S

50 mm

Fig. 2
47124-50S

75 mm

Fig. 3
47124-75S

90 mm

Fig. 4
47124-90S



COTTLE
14 cm, 5 1/4"

LEYLA Retraktor System
LEYLA Retractor System
Separador de sistema LEYLA



41843-50

Kugelgelenkkloben zum Befestigen an der OP-Tischschiene und zur Aufnahme des Haltearms 41850-41

ball and socket joint for fixation of holding rod 41850-41 at the operating table

articulacion esferica, para sujetar el brazo de soporte rigido sobre la mesa de operaciones 9 x 32 mm



41850-41

starrer Haltearm, auseinandernehmbar, zur Fixation im Kugelgelenkkloben 41843-50 und zur wahlweisen Aufnahme des Kupplungskopf

holding rod, detachable, for fixation in ball and socket joint 41843-50 and to hold a desired coupling head

brazo de soporte rigido, desmontable, para fijacion a la articulacion esferica 41843-50 y opcionalmente a las cabezas

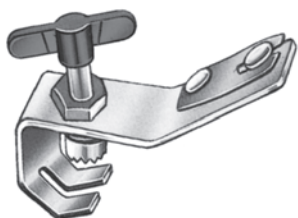

41821-21

Fixiervorrichtung zum Befestigen an Rohrteilen bis Ø 16 mm

clamp for fixation on bars up to Ø 16 mm

dispositivo de fijacion para tubos hasta Ø 16 mm



41842-44

Kupplungskopf, drehbar, zur Aufnahme von 1 flexiblen Spannarm 41810-10

coupling head, turnable, to hold 1 flexible arm 41810-10

acoplamiento, para fijacion de un brazo flexible 41810-10

Nasenpinzetten
Nasal Forceps
Pinzas nasales



TROELTSCH
47151-15
15 cm, 6"

TROELTSCH
47151-18
18 cm, 7"

Nasenpinzetten
Nasal Forceps
Pinzas nasales



JANSEN-GRUENWALD
47154-20
20 cm, 8"

1x2



JANSEN
47155-20
20 cm, 8"

Nasenpinzetten
Nasal Forceps
Pinzas nasales



GRAEFE
11190-10 10,5 cm, 4.1"



McINDOE
11258-15 15,0 cm, 6"
11259-15 TC 15,0 cm, 6"



1x2

GILLIES
11272-15 15,5 cm, 6"
11273-15 TC 15,5 cm, 6"

Nasenpinzetten
Nasal Forceps
Pinzas nasales



45201-11
12 cm, 4 □"

45201-13
13 cm, 5 1/8"

45203-11
12 cm, 4 □"

WILDE (TROELTSCH)



LUCAE
45206-14 14 cm, 5 □"
45206-16 16 cm, 6 □"

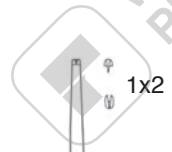

45207-16



COTTLE
45208-14
14 cm, 5 □"

Columella-Pinzette
Columella Forceps
Pinzas para columna

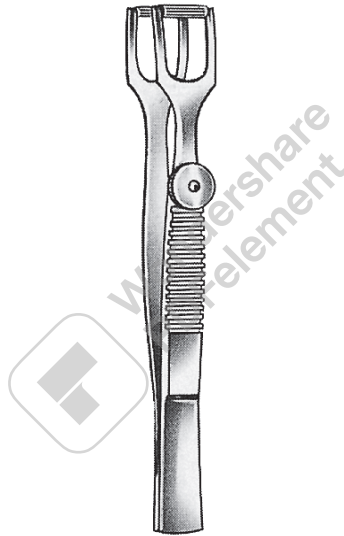

COTTLE
47565-10
10 cm, 4"

Nasentamponzangen
Nasal Dressing Forceps
Pinzas nasales para taponamiento



WESTMACOTT
47158-20 20 cm, 8"



LUBET-BARBON
47159-20 20 cm, 8"



HARTMANN
47161-16 16 cm, 6 1/4"



HARTMANN
47161-20 20 cm, 8"

Nasentamponzangen
Nasal Dressing Forceps
Pinzas nasales para taponamiento



LISTER (Sinus)
17210-13 13 cm, 5 1/8"
17210-16 16 cm, 6 1/4"
17210-18 18 cm, 7"

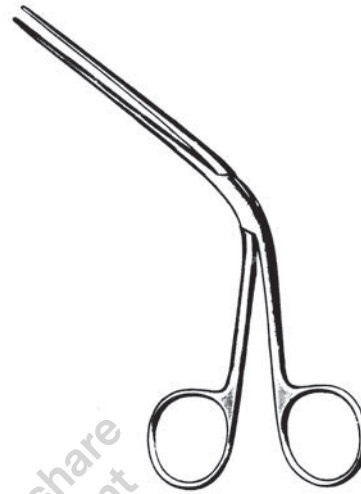

TILLEY
45243-14
14 cm, 5 1/2"

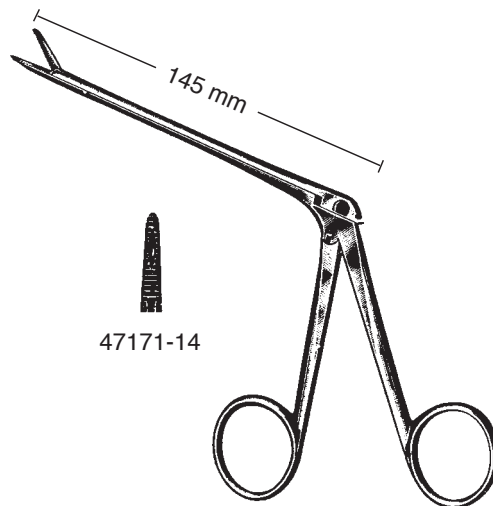

47171-14

47173-14

NOYES
14,5 cm, 5 3/4"

Polypenzangen
Nasal Polypus Forceps
Pinzas para pólipos



LITTAUER
47167-18
18 cm, 7"

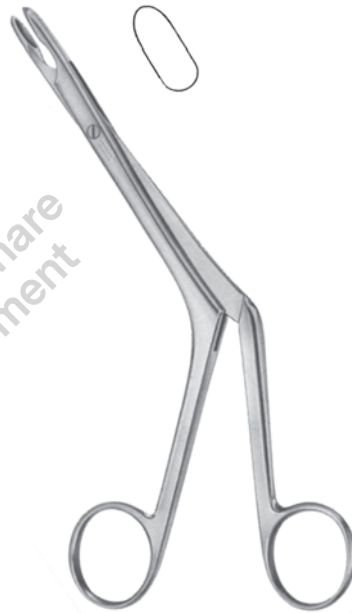

HEYMANN-KNIGHT
47169-18
18 cm, 7"

Nasen Septumzangen
Nasal Septum Forceps
Pinzas para el tabique nasal

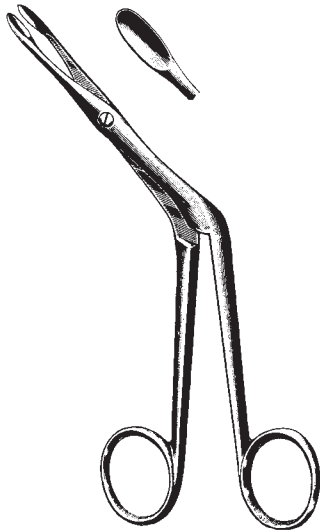

HEYMANN
47181-18
18 cm, 7"



KNIGHT
47185-18
18 cm, 7"

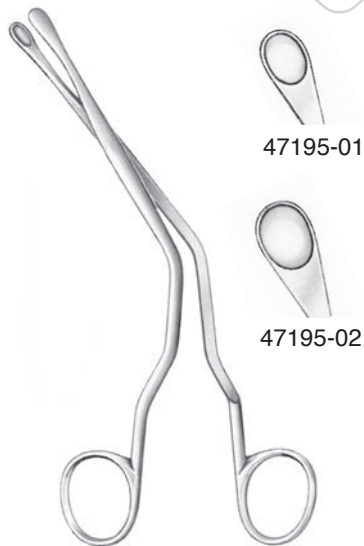

LUC
19 cm, 7 1/2"

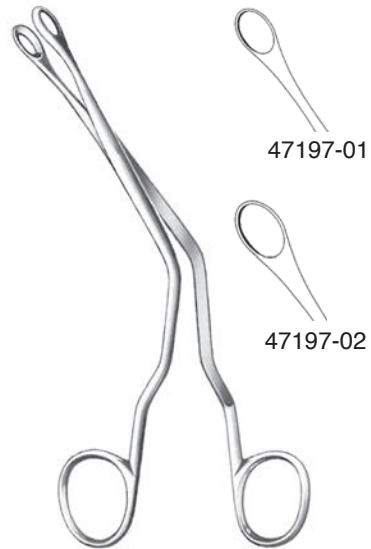

LUC
19 cm, 7 1/2"

Nasen Septumzangen
Nasal Septum Forceps
Pinzas para el tabique nasal

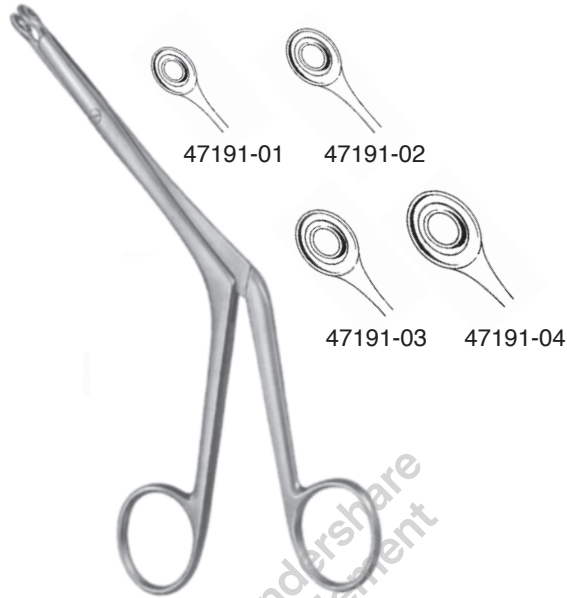

47191-01

47191-02

47191-03

47191-04

BRUENINGS
19 cm, 7 1/2"



Vomerzange
Vomer Forceps
Pinza para el vómer

CRAIG
47192-18
18 cm, 7"



47193-01

47193-02

CRAIG-DOMNICK
17 cm, 6 1/2"

Nasen Septumzangen
Nasal Septum Forceps
Pinzas para el tabique nasal



MIDDLETON-JANSEN
47323-19
19 cm, 7 1/2"



MIDDLETON-JANSEN
47325-19
19 cm, 7 1/2"

Septumrichtzangen
Septum Straightening Forceps
Pinza para enderezar el tabique nasal



ASCH
47571-23
23 cm, 9"

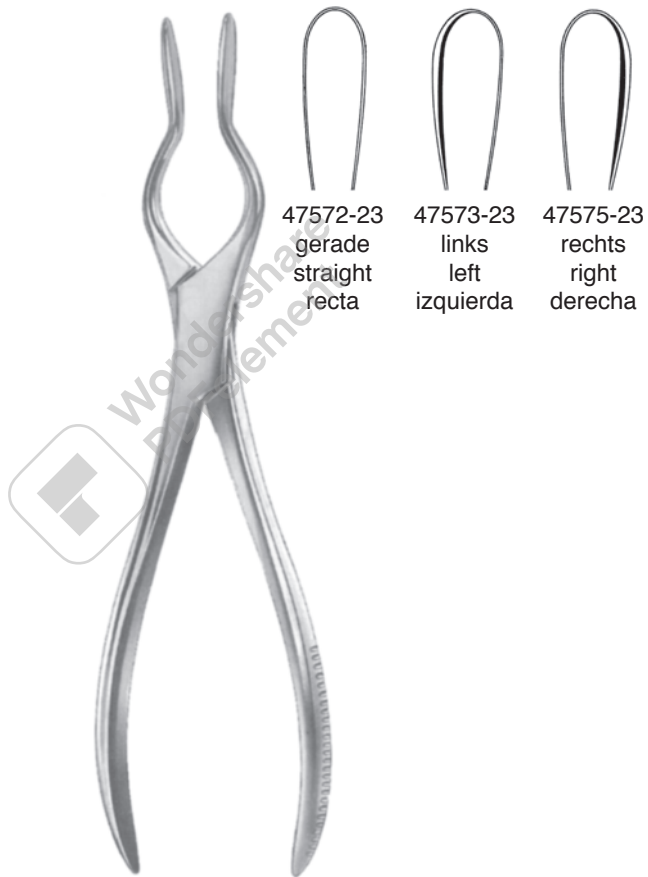

WALSHAM
47572-23
23 cm, 9"

Quetschzange
Morselizer Forceps
Pinza para aplastar



RUBIN
47251-21
21 cm, 8 1/4"

Polypenschnürer
Nasal Polypus Snares
Polipótomos



KRAUSE-VOSS
47350-26
26 cm, 10 □"



KRAUSE
47351-26
26 cm, 10 □"

Polypenschnürer
Nasal Polypus Snares
Polipótomos

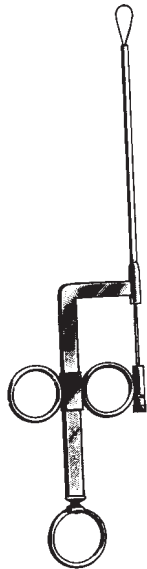

WILDE
47352-24
24 cm, 9 □"

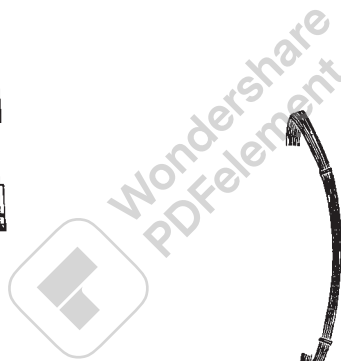

Bündel mit 12 Stück
Bundle of 12 pieces
paquete de 12 piezas

47355-03 0,3 mm

Siebbeinzangen
Ethmoid Forceps
Pinzas para etmoides

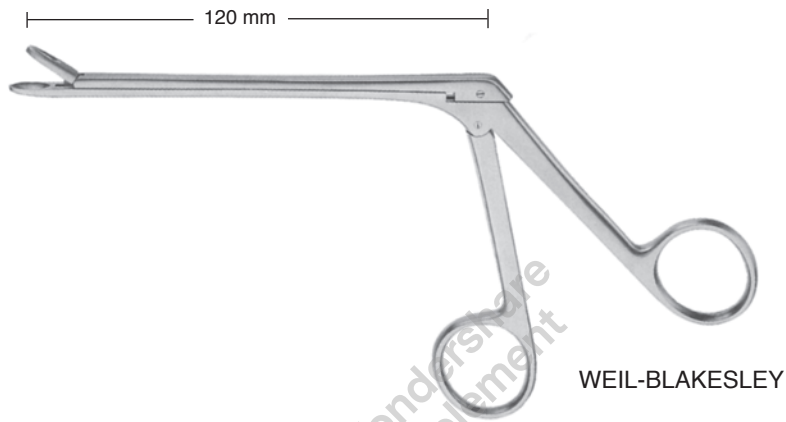
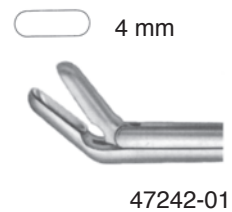
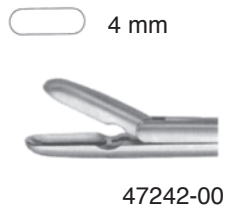
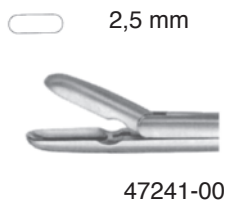
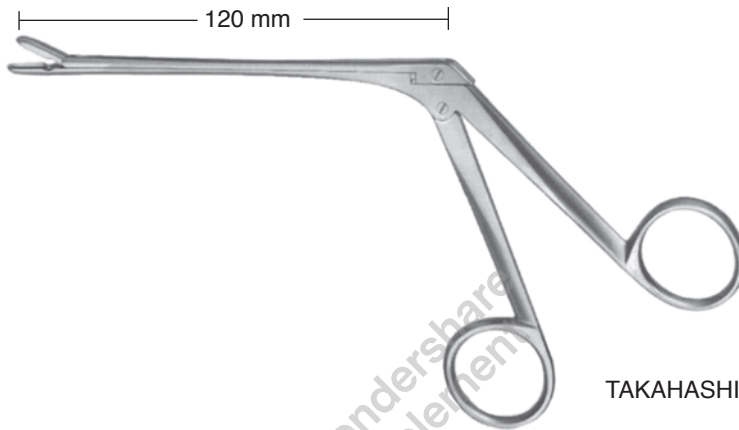
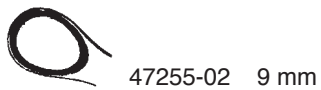
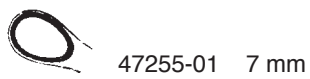
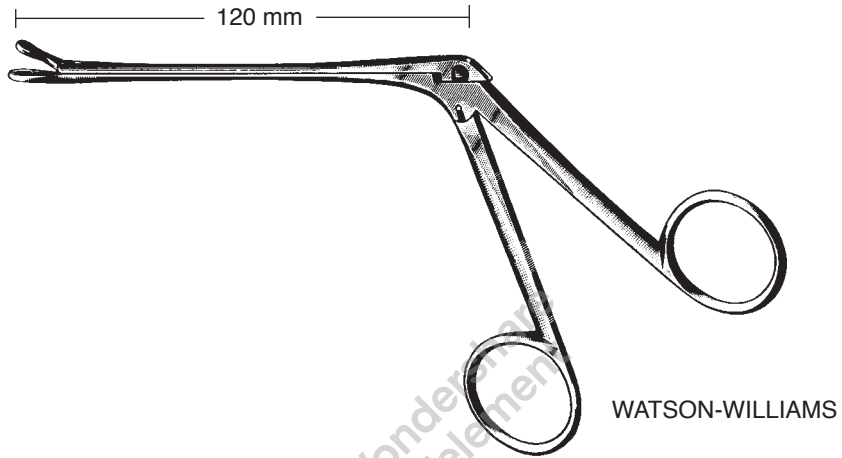

	Fig. 0	Fig. 1	Fig. 2	Fig. 3	Fig. 4	Fig. 5
	47223-00 2,5 mm	47223-01 3,0 mm	47223-02 3,6 mm	47223-03 4,2 mm	47223-04 4,8 mm	47223-05 5,8 mm
	47224-00 2,5 mm	47224-01 3,0 mm	47224-02 3,6 mm	47224-03 4,2 mm	47224-04 4,8 mm	47224-05 5,8 mm
		47225-01 3,0 mm	47225-02 3,6 mm	47225-03 4,2 mm	47225-04 4,8 mm	

Siebbeinzangen
Ethmoid Forceps
Pinzas para etmoides



Siebbeinzangen
Ethmoid Forceps
Pinzas para etmoides



Nasenzange
Nasal Forcep
Pinza nasal

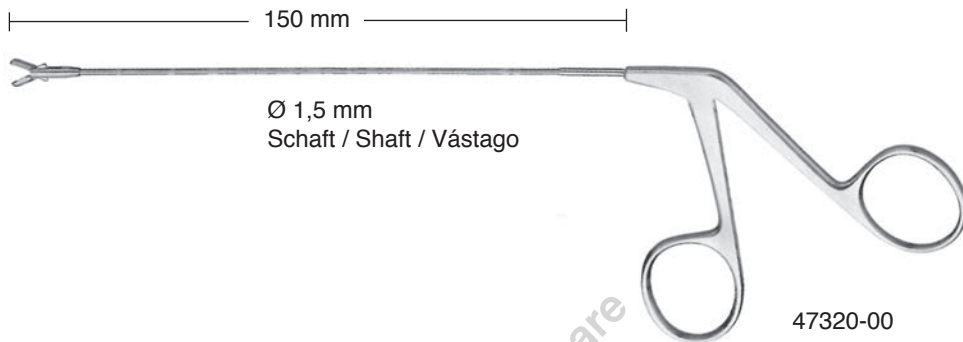

3 x 5 mm



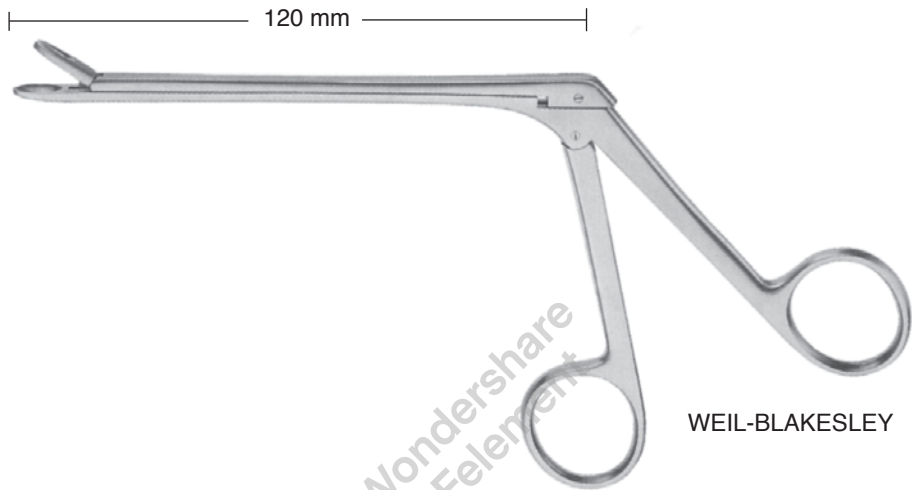

Biopsiezange mit Löffelmaul
Biopsy Forceps with cup jaw
Pinza para biopsia con boca en forma de cucharilla

Nasal Cutting Forceps
Pinzas nasales cortantes



WEIL-BLAKESLEY

			
	47226-01 2,0 mm	47226-02 2,5 mm	47226-03 3,0 mm
	47227-01 2,0 mm	47227-02 2,5 mm	47227-03 3,0 mm

Nasenzangen, durchschneidend
Nasal Cutting Forceps
Pinzas nasales cortantes

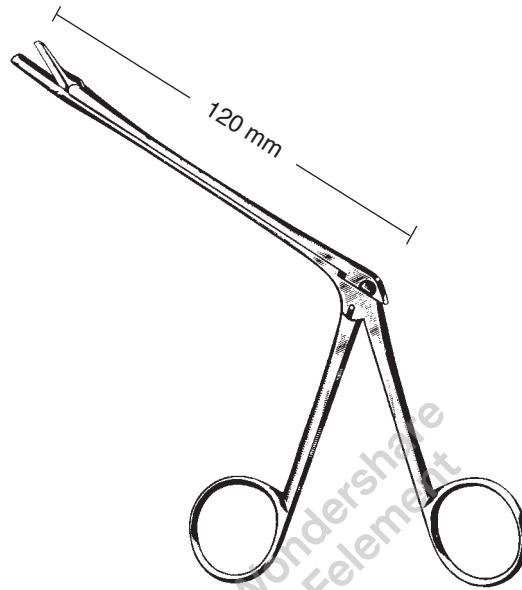

STRUYCKEN
47240-19

 47235-05
5 mm

 47235-07
7 mm

 47235-09
9 mm

 47235-11
11 mm



HARTMANN

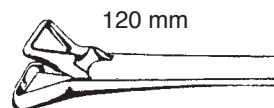
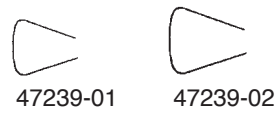

SCHMEDEN

Scharfe Nasenzangen, durchschneidend
 Nasal Cutting Forceps
 Pinzas nasales cortantes

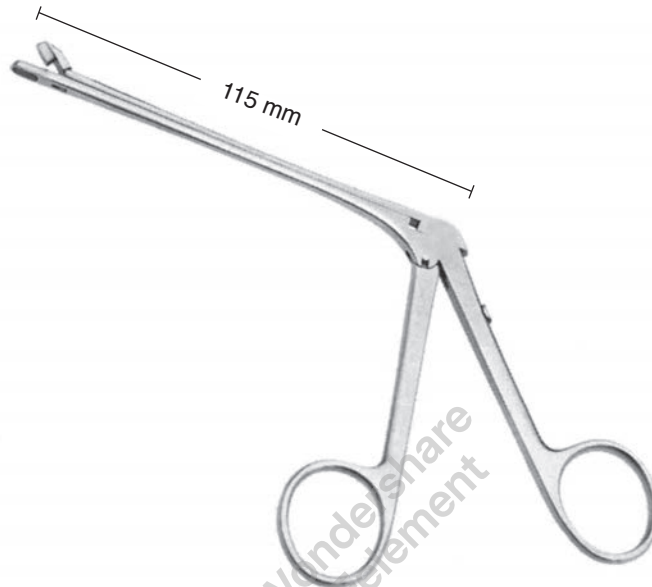

gerade
 straight
 recta



47230-00
 2,7 x 6,8 mm



47230-01
 3 x 7,7 mm

aufgewinkelt
 angled up
 angulada hacia arriba



47230-02
 2,2 x 6,5 mm



47230-03
 2,6 x 6,5 mm



47230-04
 3 x 6,5 mm

fein, gerade
 delicate, straight
 fina, recta



47230-05
 1,4 x 5 mm

fein, aufgewinkelt
 delicate, angled up
 fina, angulada hacia arriba



47230-06
 1,4 x 4 mm

Scharfe Nasenzangen
Nasal Cutting Forceps
Pinzas nasales cortantes

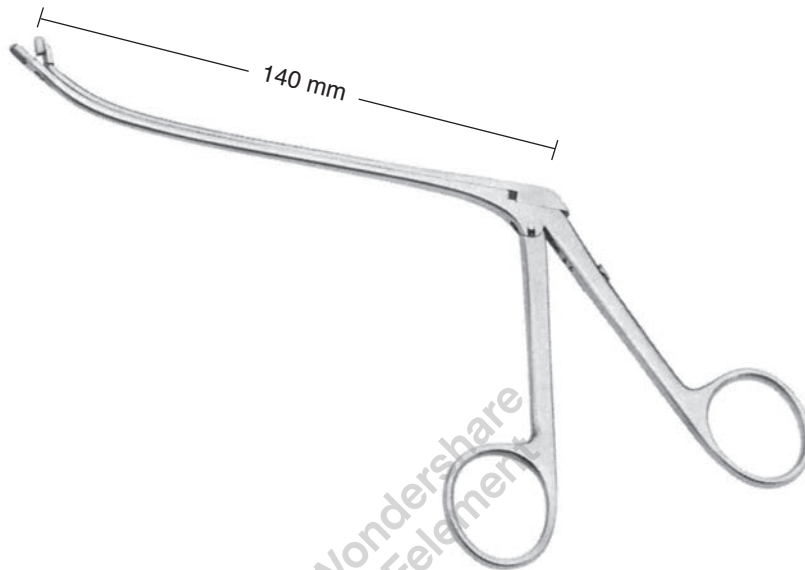

47231-00
3 x 7,4 mm

aufgebogen
curved up
curvada hacia arriba



47231-01
1,4 x 5 mm

fein, aufgebogen
delicate, curved up
fina, curvada hacia arriba



47231-02
1,4 x 4 mm

fein, aufgebogen, gewinkelt
delicate, curved up, angled
fina, curvada hacia arriba, angulada

Scharfe Nasenzange
Nasal Cutting Forcep
Pinza nasal cortante



47232-00
2,6 x 4,5 mm

rückwärts schneidend, aufgebogen
backward cutting, curved up
corte retrogrado, curvada hacia arriba

Scharfe Nasenzangen
Nasal Cutting Forceps
Pinzas nasales cortantes



47233-00
3 x 5 mm

fein, gerade
delicate, straight
fina, recta



47233-01
3 x 5 mm

fein, aufgewinkelt
delicate, angled
fina, angulada hacia arriba

Scharfe Nasenzangen
Nasal Cutting Forceps
Pinzas nasales cortantes

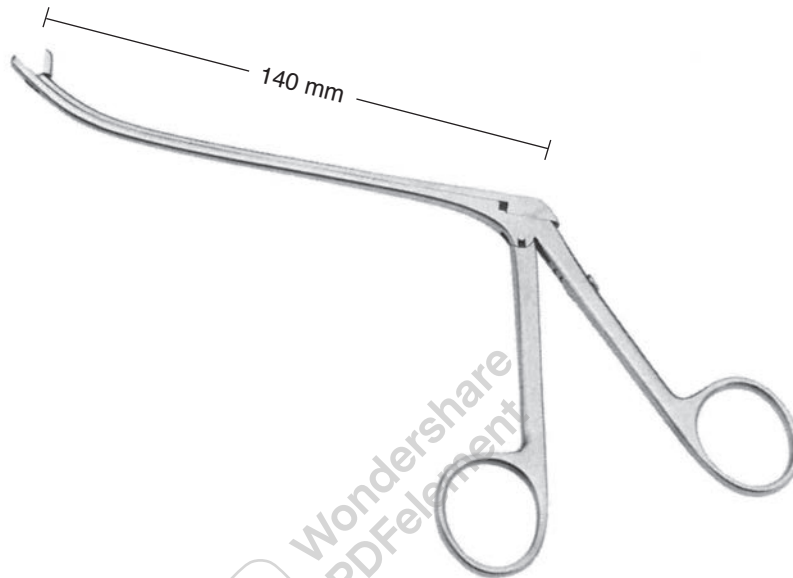

47233-02
4 x 5 mm

aufgebogen
curved up
curvada hacia arriba



47233-03
3 x 5 mm

fein, aufgebogen
delicate, curved up
fina, curvada hacia arriba

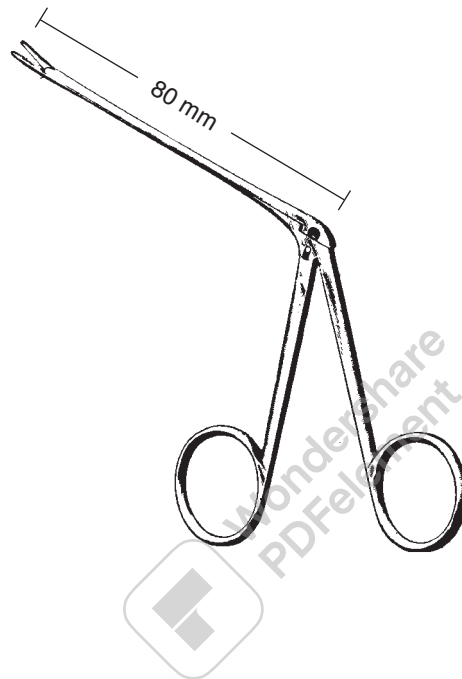
Fremdkörperzängchen
Ear Polypus Forceps
Pinzas para pólipos

◦ 1 mm Ø



HARTMANN-WULLSTEIN
45257-08
8,5 cm, 3.4"



Ø mm	HARTMANN
2,0	45267-20 8,5 cm, 3.4"
2,5	45267-25 8,5 cm, 3.4"

○ 2 mm Ø



HARTMANN-HOFFMANN
45275-08
8,5 cm, 3.4"

Kieferhöhlen-Fasszange
Maxillary Sinus Forceps
Pinza de agarre para el seno maxilar

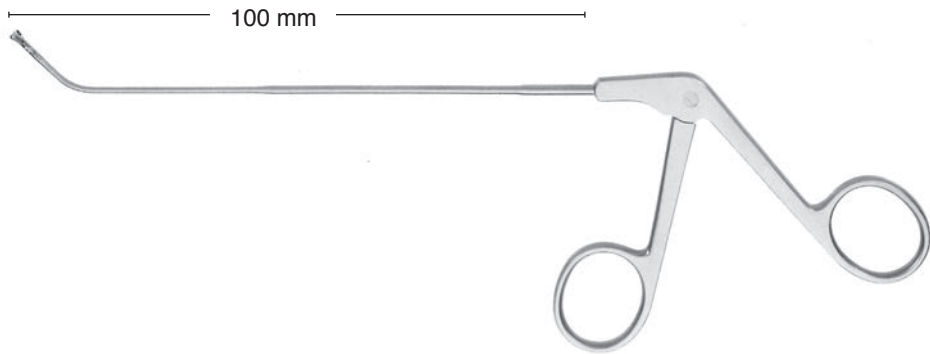

Maulteil starr
Jaw rigid
Boca rigida



47324-01

90° rückwärts öffnend nach unten
90° backward opening downwards
apertura de 90° hacia atrás hacia abajo



47324-02

120° rückwärts öffnend nach unten
120° backward opening downwards
apertura de 120° hacia atrás hacia abajo

Kieferhöhlen-Fasszange
Maxillary Sinus Forceps
Fórceps del seno maxilar

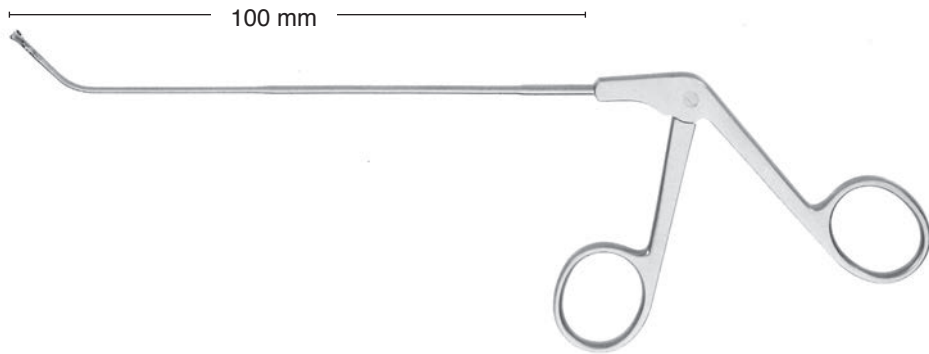

Maulteil starr
Jaw rigid
Boca rígida



47324-05

90° rückwärts öffnend nach oben

90° backward opening top

apertura de 90° hacia atrás hacia arriba



47324-04

90° rückwärts öffnend nach rechts

90° backward opening right

apertura de 90° hacia atrás hacia la derecha



47324-03

90° rückwärts öffnend nach links

90° backward opening left

apertura de 90° hacia atrás hacia la izquierda

Nasenzangen, durchschneidend
 Nasal Cutting Forceps
 Pinzas nasales cortantes

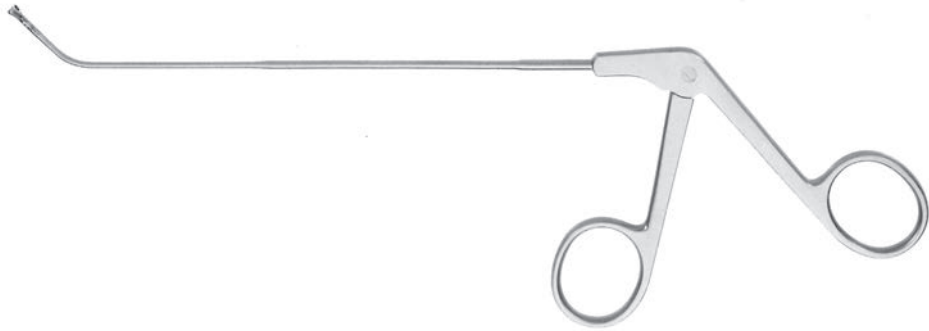

nach oben gebogen
 curved upward
 curvada hacia arriba



Doppellöffel, horizontal öffnend
 Cup, double action horizontal jaw
 Boca en forma cuchara de doble accion, boca horizontal

	70°	90°	110°
Ø 2 mm	47316-70	47316-90	47316-11
Ø 3 mm	47317-70	47317-90	47317-11
Ø 4 mm	47320-70	47320-90	47320-11



Doppellöffel, vertikal öffnend
 Cup, double action vertical jaw
 Boca en forma cuchara de doble accion, boca vertical

	70°	90°	110°
Ø 2 mm	47321-70	47321-90	47321-11
Ø 3 mm	47318-70	47318-90	47318-11
Ø 4 mm	47322-70	47322-90	47322-11



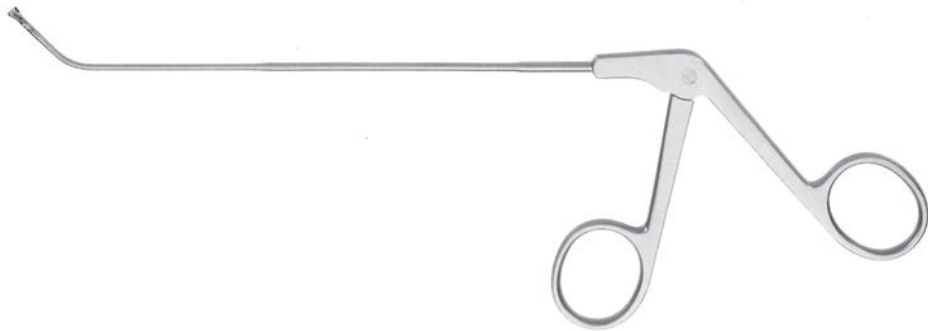

Doppellöffel BUTTERFLY, horizontal öffnend
 BUTTERFLY cup, double action horizontal jaw
 Boca en forma cuchara de doble accion BUTTERFLY,
 boca horizontal

	80°	100°
Ø 3 mm	47323-80	47323-10

Biopsie Stanze
Biopsy Punch
Pinza para biopsia



Biopsie Stanze, Schnitt 2,5 x 5 mm, einfach vertikalen Kiefer
 Biopsy punch, cut 2.5 x 5 mm, single action vertical jaw
 Pinza para biopsia, corte de 2,5 x 5 mm, boca vertical de simple accion

	Schaft Shaft Vástago	vertikal öffnend vertical opening apertura vertical	links öffnend left opening apertura a la izquierda	rechts öffnend right opening apertura a la derecha
 Arbeitslänge 90 mm Working length 90 mm Largo util de 90 mm	70° gebogen curved curvo	47325-01	47325-02	47325-03
 Arbeitslänge 105 mm Working length 105 mm Largo util de 105 mm	gerade straight recto	47326-01	47326-02	47326-03
 Arbeitslänge 105 mm Working length 105 mm Largo util de 105 mm	70° gebogen curved curvo	47327-01	47327-02	47327-03



Nasenzangen, Rohrschaft, einfachbeweglich
 Nasal Forceps, Tube Shaft, single action jaws
 Pinzas nasales, vastago tubular, simple accion

BLAKESLEY Nasenzange, Arbeitslänge 130 mm
 BLAKESLEY nasal forceps, working length 130 mm
 Pinza nasal BLAKESLEY, largo util de 130 mm

Maul gefenstert und gerade
 Jaw fenestrated, straight
 Boca fenestrada y recta







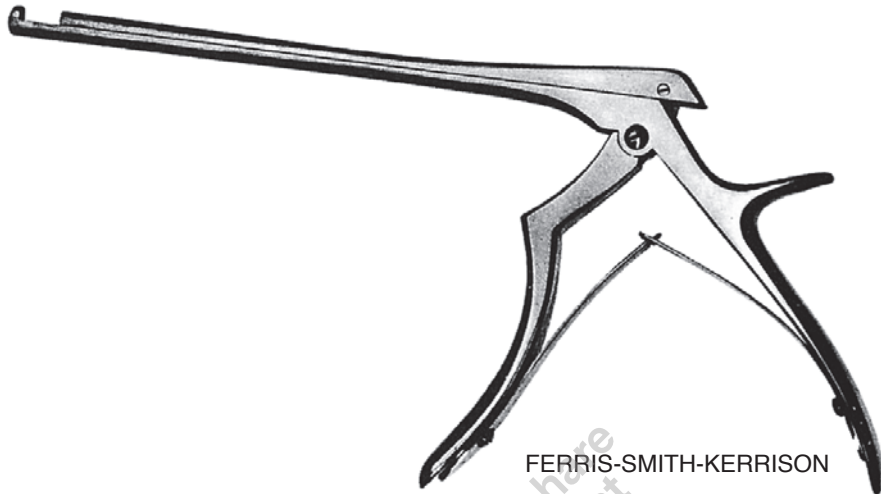

Schnitt / Cut / corte	3,0 mm	3,5 mm	4,0 mm
	47223-30	47223-35	47223-40
	47226-30	47226-35	47226-40

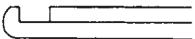
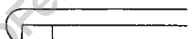
Maul gefenstert und 45° nach oben abgewinkelt
 Jaw fenestrated and 45° angled upwards
 Boca fenestrada y angulada hacia arriba en 45°

Schnitt / Cut / corte	3,0 mm	3,5 mm	4,0 mm
	47224-30	47224-35	47224-40
	47227-30	47227-35	47227-40

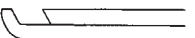
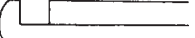
Knochenstanzen
Bone Punch
Pinzas para huesos

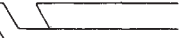
FERRIS-SMITH-KERRISON

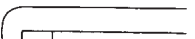
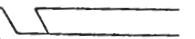
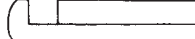
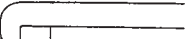
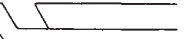
	90°	90°	40°
18 cm, 7"	 41510-01 1 mm	 41511-01 1 mm	 41512-01 1 mm
18 cm, 7"	 41510-02 2 mm	 41511-02 2 mm	 41512-02 2 mm
18 cm, 7"	 41510-03 3 mm	 41511-03 3 mm	 41512-03 3 mm
18 cm, 7"	 41510-04 4 mm	 41511-04 4 mm	 41512-04 4 mm
18 cm, 7"	 41510-05 5 mm	 41511-05 5 mm	 41512-05 5 mm

auch lieferbar mit Dünnpfuf
also available with thin foot plate
tambien disponible con lámina de punzonar estrecha

Stanzen
Punches
Pinzas



KERRISON
17 cm, 6 1/4"

3x3 mm 47303-03
4x4 mm 47303-04
5x5 mm 47303-05
6x6 mm 47303-06

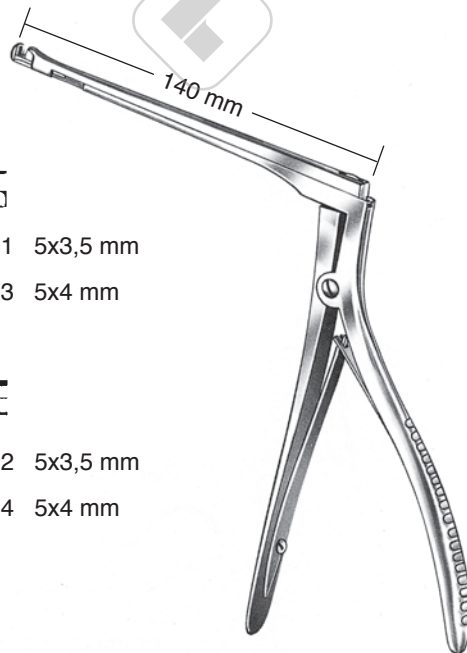

⌒ 47304-01 5x3,5 mm

⌒ 47304-03 5x4 mm



⌒ 47304-02 5x3,5 mm

⌒ 47304-04 5x4 mm

HAJEK-KOFLER

Stanze
Punch
Pinza

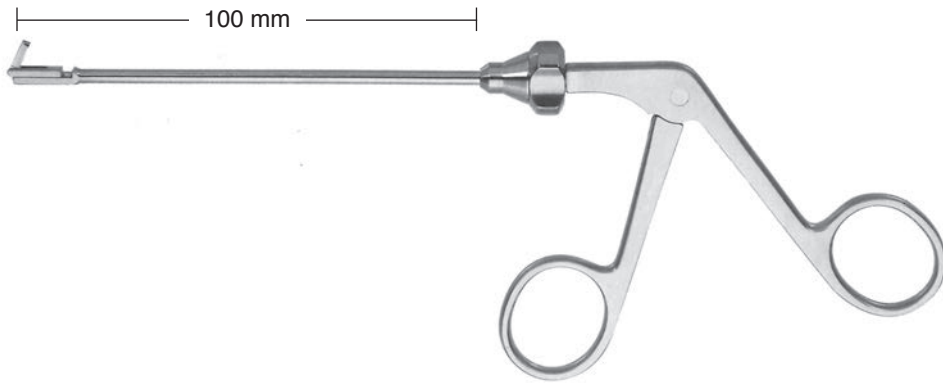

HAJEK-KOFLER
47316-16
3,5 mm

Antrumstanzen
 Antrum Punches
 Pinzas para antro

 Retro Stanzen
 Retro Punches
 Pinza retrograda

Ø 4,5 mm

 starr, Schnitt 2,5 x 6,5 mm
 rigid, cut 2.5 x 6.5 mm
 rigida, corte 2,5 x 6,5 mm

- 47310-00 rechts schneidend / right cutting / corte hacia la derecha
 47311-00 links schneidend / left cutting / corte hacia la izquierda
 47312-00 nach oben schneidend / upward cutting / corte hacia arriba
 47313-00 nach unten schneidend / downward cutting / corte hacia abajo



Ø 3,0 mm

 starr, Schnitt 2,0 x 5,0 mm
 rigid, cut 2.0 x 5.0 mm
 rigida, corte 2,0 x 5,0 mm

- 47316-00 rechts schneidend / right cutting / corte hacia la derecha
 47317-00 links schneidend / left cutting / corte hacia la izquierda
 47315-00 nach oben schneidend / upward cutting / corte hacia arriba
 47314-00 nach unten schneidend / downward cutting / corte hacia abajo



Ø 3,0 mm

 Schnitt 2,0 x 5,0 mm
 Cut 2.0 x 5.0 mm
 corte 2,0 x 5,0 mm

- 47318-00 360° drehbar / rotatable / giratoria

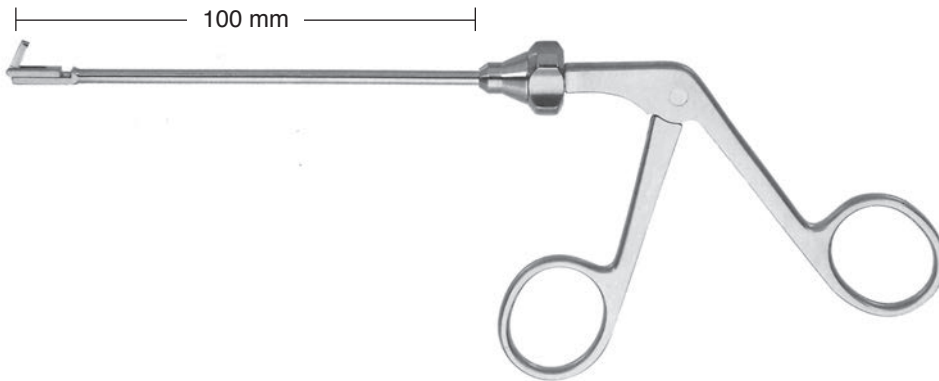
Antrumstanzen
Antrum Punches
Pinzas para antro

Retro Stanzen, für Kinder
Retro punches, for children
Pinza retrograda, para niños



Ø 3,0 mm

starr, Schnitt 1,5 x 3,5 mm
rigid, cut 1.5 x 3.5 mm
rigida, corte 1,5 x 3,5 mm

47321-00 rechts schneidend / right cutting / corte hacia la derecha
47322-00 links schneidend / left cutting / corte hacia la izquierda
47323-00 nach oben schneidend / upward cutting / corte hacia arriba
47324-00 nach unten schneidend / downward cutting / corte hacia abajo



Ø 3,0 mm

Schnitt 1,5 x 3,5 mm
Cut 1.5 x 3.5 mm
corte 1,5 x 3,5 mm

47325-00 360° drehbar / rotatable / giratoria

Zirkular Stanze
 Circular Punch
 Pinza circular

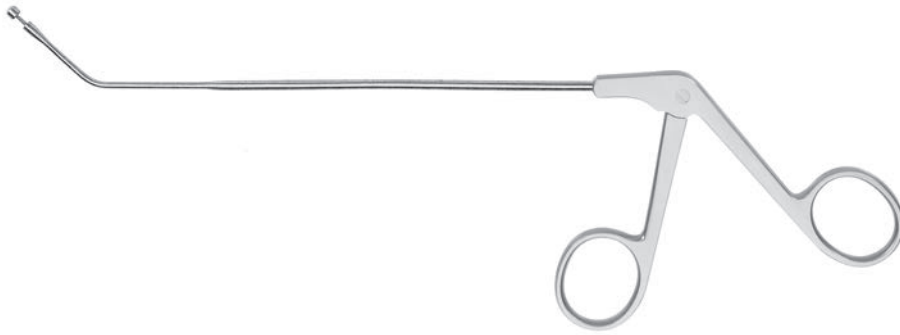

360° schneidend / cutting / cortante

gerader Schaft
 shaft straight
 vástago recto

45° nach oben gebogen
 45° curved upward
 curvada hacia arriba en 45°

Ø 3,5 mm 47319-35
 Ø 4,5 mm 47319-45

47320-35
 47320-45

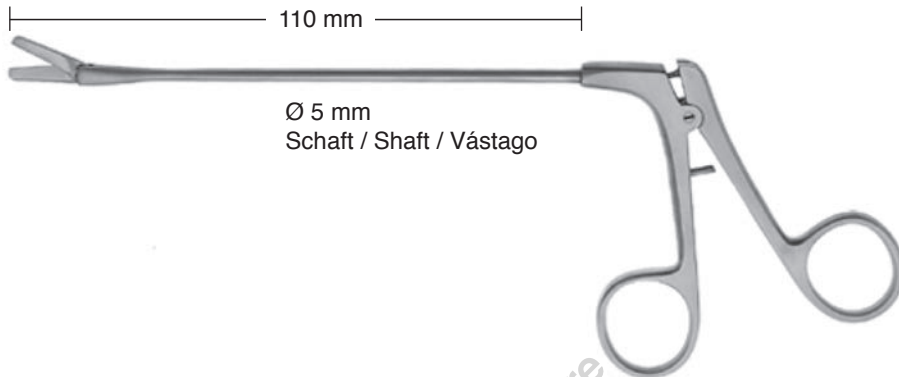
Nasenscheren
Nasal Scissors
Tijeras nasales47305-01
gerade
straight
recta47305-02
rechts gebogen
right curved
curvada hacia la derecha47305-03
links gebogen
left curved
curvada hacia la izquierda

Präparierscheren
Dissecting Scissors
Tijeras de disección



METZENBAUM

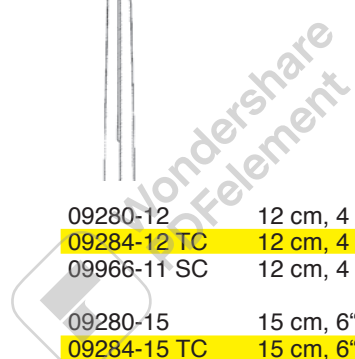

09280-12	12 cm, 4 □"	09281-12
09284-12 TC	12 cm, 4 □"	09285-12 TC
09966-11 SC	12 cm, 4 □"	09967-11 SC
09280-15	15 cm, 6"	09281-15
09284-15 TC	15 cm, 6"	09285-15 TC
09970-14 SC	15 cm, 6"	09971-14 SC
09280-18	18 cm, 7"	09281-18
09284-18 TC	18 cm, 7"	09285-18 TC
09970-18 SC	18 cm, 7"	09971-18 SC

Präparierscheren
Dissecting Scissors
Tijeras de disección



METZENBAUM



09270-15
09270-18

15 cm, 6"
18 cm, 7"



09271-15
09271-18

09274-15 TC
09274-18 TC

15 cm, 6"
18 cm, 7"

09275-15 TC
09275-18 TC



METZENBAUM-FINO



09282-15
09286-15 TC

15 cm, 6"
15 cm, 6"



09283-15
09287-15 TC

09282-18
09286-18 TC

18 cm, 7"
18 cm, 7"

09283-18
09287-18 TC

Dissecting Scissors
Tijeras de disección



SANVENERO

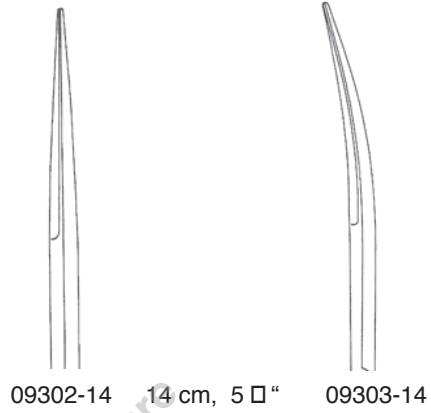

JOSEPH

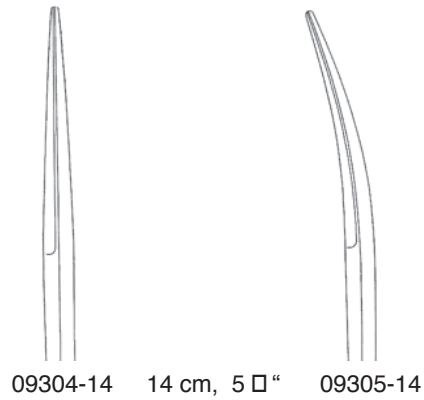

Präparierscheren
Dissecting Scissors
Tijeras de disección



- | | |
|--------------------|----------------------|
| 09310-12 | 12 cm, 4 1/4" |
| 09314-12 TC | 12 cm, 4 1/4" |
| 09995-12 SC | 12 cm, 4 1/4" |
| 09310-15 | 15 cm, 6" |

KILNER (RAGNELL)



- REYNOLDS (JAMESON)
- | | |
|-------------|-----------|
| 09321-15 | 15 cm, 6" |
| 09993-15 SC | 15 cm, 6" |
| 09321-18 | 18 cm, 7" |

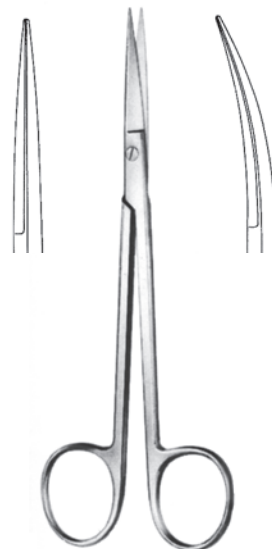

- KELLY
- | | | |
|--------------------|----------------------|--------------------|
| 09540-16 | 16 cm, 6 1/4" | 09541-16 |
| 09542-16 TC | 16 cm, 6 1/4" | 09543-16 TC |
| 09544-16 SC | 16 cm, 6 1/4" | 09545-16 SC |

Feine Scheren
Delicate Scissors
Tijeras finas



IRIS

09340-09	9 cm, 3 1/8"	09341-09
09340-10	10 cm, 4"	09341-10
09340-11	11 cm, 4 3/8"	09341-11
09344-11 TC	11 cm, 4 3/8"	09345-11 TC
09980-11 SC	11 cm, 4 3/8"	09981-11 SC



BONN

09342-08 8 cm, 3 1/8" 09343-08

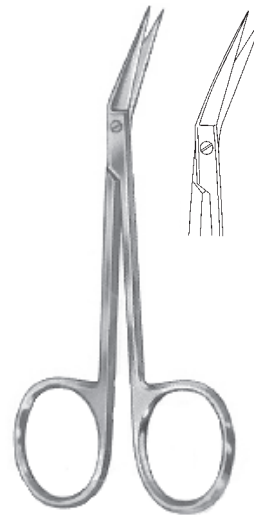

IRIS

09346-11
11 cm, 4 3/8"

Feine Scheren
Delicate Scissors
Tijeras finas



Feine Scheren
Delicate Scissors
Tijeras finas



LITTLER
09349-12
12 cm, 4 1/4"



GRAEFE
09350-10
10 cm, 4"

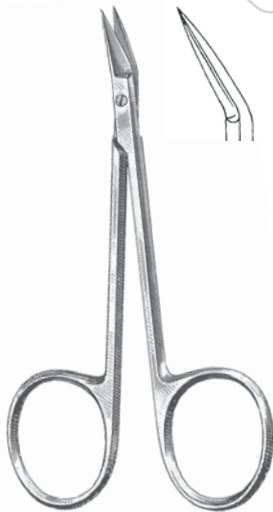

CONVERSE/WILMER/WALTER
09352-10
10 cm, 4"



COTTLE
09358-11
11 cm, 4 3/8"

Feine Scheren
Delicate Scissors
Tijeras finas



GRADLE
09350-09 9,5 cm, 3 □" 09351-09



09352-09 9,5 cm, 3 □" 09353-09



09354-10 10 cm, 4" 09355-10



09356-10 10 cm, 4" 09357-10

Feine Scheren
Delicate Scissors
Tijeras finas



STEVENS
11 cm, 4 3/8"

spitz
sharp
aguda



09360-11
09984-11SC



09361-11
09985-11 SC

stumpf
blunt
roma



09362-11



09363-11



STRABISMUS
09370-11 11 cm, 4 3/8" 09371-11
09374-11TC 11 cm, 4 3/8" 09375-11TC

Feine Scheren
Delicate Scissors
Tijeras finas



WAGNER
12 cm, 4 □"



09828-12



09826-12



09824-12
0982-12SC



WAGNER
12 cm, 4 □"



09823-12



09829-12



09825-12
09825-12 SC

Nasenscheren
Nasal Scissors
Tijeras nasales



HEYMAN
09401-18 18 cm, 7"



FOMON
09403-15 15 cm, 6"



COTTLE
09405-16 16 cm, 6 1/4"
09405-16TC 16 cm, 6 1/4"



COTTLE-MASING
09406-10 10 cm, 4" 09407-10



FOMON
09617-13 13 cm, 5 1/8"

Fadenscheren
Stitch Scissors
Tijeras para hilos



SPENCER
09802-09 9 cm, 3 1/4"
09802-11 11 cm, 4 3/8"



LITTAUER
09804-14
14 cm, 5 1/2"



O`BRIEN
09805-09
9 cm, 3 1/4"

Face Lift Scheren
Face Lift Scissors
Face Lift tijeras

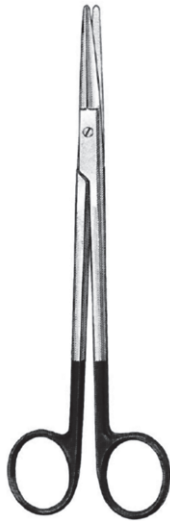

GORNEY
19 cm, 7 1/2"

10010-19	10011-19
10012-19 TC	10013-19 TC
10014-19 SC	10015-19 SC



GORNEY-FREEMAN

10061-19	19 cm, 7 1/2"
10061-19 TC	19 cm, 7 1/2"
10061-19 SC	19 cm, 7 1/2"
10061-23	23 cm, 9"
10061-23 TC	23 cm, 9"
10061-23 SC	23 cm, 9"

Face Lift Scheren
Face Lift Scissors
Face Lift tijeras



KAYE

10028-14 TC	14 cm, 5 1/2"	10029-14 TC
10034-14 SC	14 cm, 5 1/2"	10035-14 SC
10030-18 TC	18 cm, 7"	10031-18 TC
10036-18 SC	18 cm, 7"	10037-18 SC
10032-23 TC	23 cm, 9"	10033-23 TC
10038-23 SC	23 cm, 9"	10039-23 SC



PECK-JOSEPH

10044-14	14,5 cm, 5 3/4"	10045-14
10048-14 SC	14,5 cm, 5 3/4"	10049-14 SC



BEUSE

10050-14	14 cm, 5 1/2"	10051-14
10050-18	18 cm, 7"	10051-18

Blepharoplastik Scheren
Blepharoplasty Scissors
Tijeras para blefaroplastia



GREENBERG-PAR

10201-11 11,5 cm, 4 □“
10201-11SC 11,5 cm, 4 □“



KAYE

10206-11 11,5 cm, 4 □“ 10207-11
10206-11SC 11,5 cm, 4 □“ 10207-11SC

Mikro Scheren
Micro Scissors
Micro tijeras

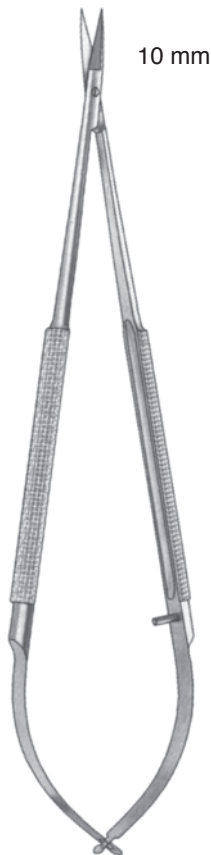

10 mm

11 cm, 4 $\frac{3}{8}$ "

10202-11

10203-11

14,5 cm, 5 \square "

10202-14
10202-14T

10203-14
10203-14T

18 cm, 7"

10202-18
10202-18T

10203-18
10203-18T

T= Titan, titanium, titanio

Mikro Scheren
Micro Scissors
Micro tijeras

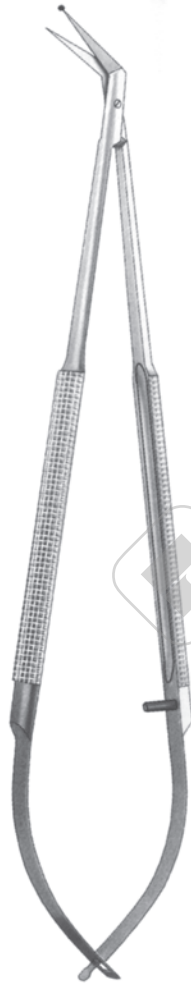

18 cm, 7"



25°

10220-25

10220-25T



45°

10220-45

10220-45T



60°

10220-60

10220-60T



90°

10220-90

10220-90T



125°





10220-00

10220-00T

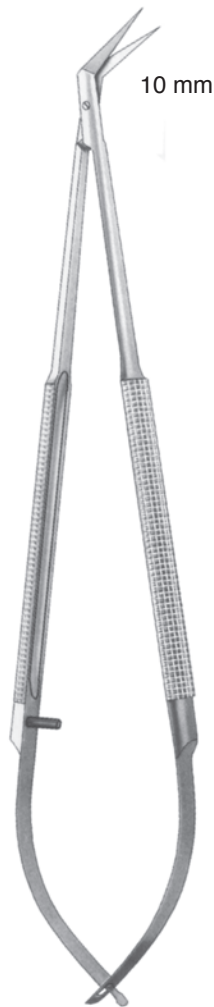
T= Titan, titanium, titanio

Mikro Scheren
Micro Scissors
Micro tijeras

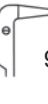

	11 cm 4 3/8"	14,5 cm 5 3/4"	18 cm 7"
 25°	10226-11	10226-14	10226-18 10226-18T
 45°	10227-11	10227-14	10227-18 10227-18T
 60°	10228-11	10228-14	10228-18 10228-18T
 90°	10229-11	10229-14	10229-18 10229-18T
 125°	10230-11	10230-14	10230-18 10230-18T

T= Titan, titanium, titanio

Nasenschere
Nasal Scissor
Tijera nasal

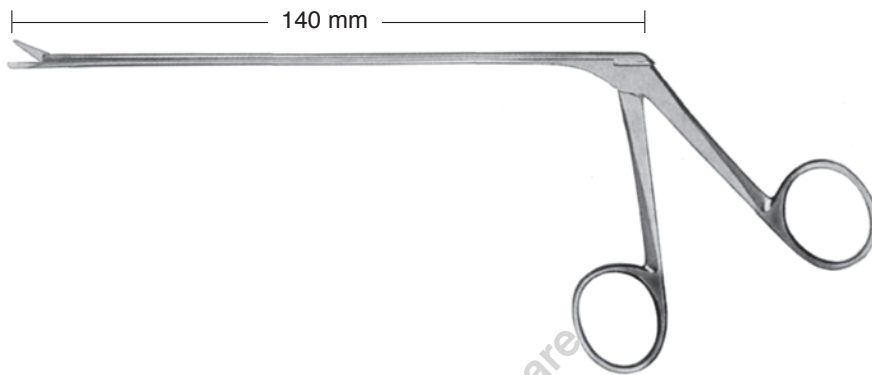

CAPLAN
47256-20
20 cm, 8"

Tumorschere
Tumor Scissors
Tijera para tumores

93755-14

gerade
straight
recta

93756-14

rechts gebogen
curved right
curvada hacia la derecha

93757-14

links gebogen
curved left
curvada hacia la izquierda

Knochensplitterzangen
Bone Cutting Forceps
Pinzas cortantes para huesos



COTTLE-KAZANJIAN
33282-19
19 cm, 7 1/2"



MC INDOE
33283-17
17 cm, 6 3/4"

Nadelhalter
Needle Holders
Porta-agujas



DERF
25110-12 12 cm, 4 □“ 25114-12 TC



WEBSTER
25128-13 13 cm, 5 1/8“
25129-13 TC 13 cm, 5 1/8“

BABY-WEBSTER
25136-11 11 cm, 4 3/8“
25137-11 TC 11 cm, 4 3/8“



HALSEY
25130-13 13 cm, 5 1/8“ 25140-13
25134-13 TC 13 cm, 5 1/8“ 25144-13 TC



CRILE-WOOD
25160-15 15 cm, 6“ 25164-15 TC

Saug- und Spülinstrumente
Suction and Irrigation Instruments
Instrumentos de aspiración y irrigación

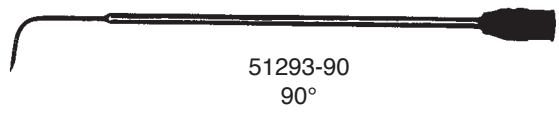
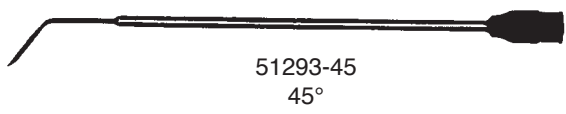
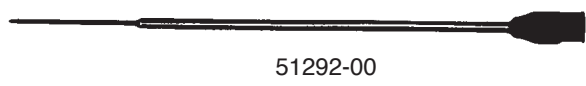
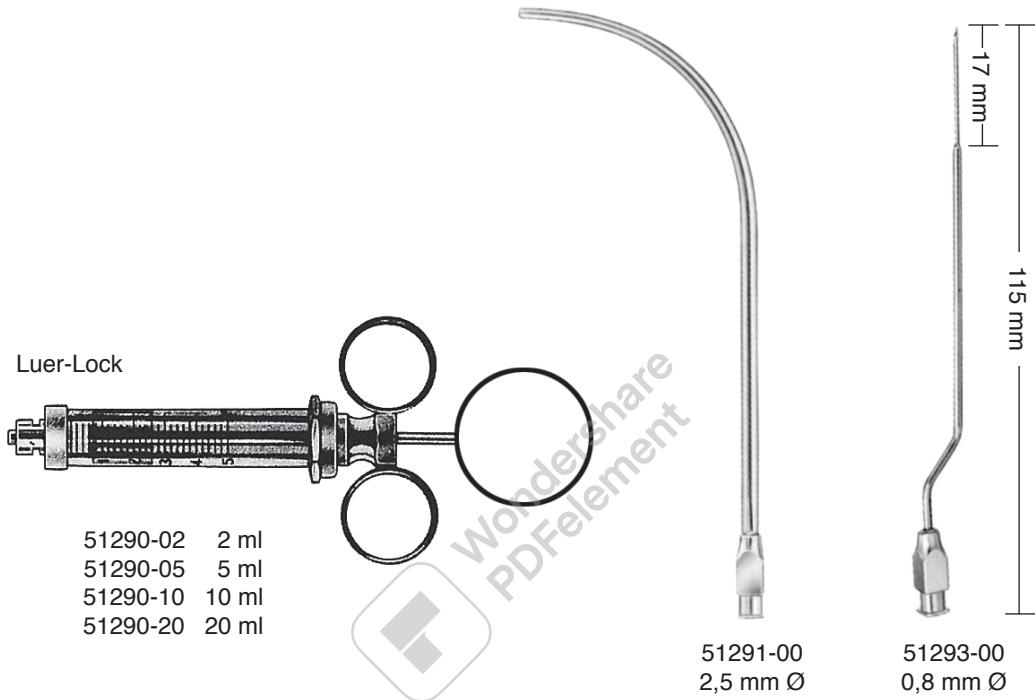

Saugrohre
Suction Tubes
Tubos de aspiración

Koagulations-Saugrohr, gerade
Coagulation Suction Tube, straight
Tubo de succión y coagulación, recto



41312-10
Nutzlänge 10 cm, 4"
Working length 10 cm, 4"
Largo útil 10 cm, 4"

41312-26
Nutzlänge 26 cm, 10 □"
Working length 26 cm, 10 □"
Largo útil 26 cm, 10 □"

Kabelanschluß männlich
Cable connector male
Conexion del cable macho

Spülkanülen
Irrigating Tubes
Canulas irrigadoras

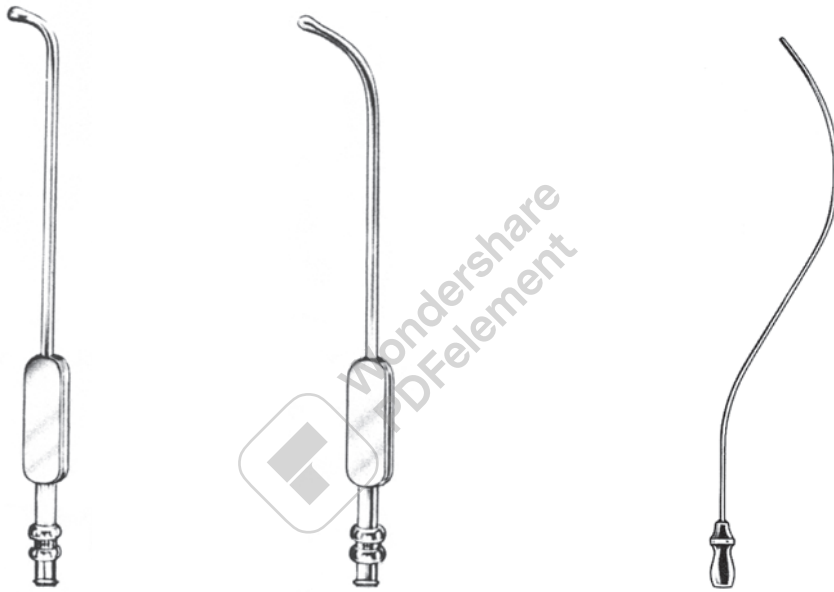

EICKEN (KILLIAN)
14,5 cm, 5 □"
Ø

47331-20	2,0 mm	47332-20
47331-25	2,5 mm	47332-25
47331-30	3,0 mm	47332-30
47331-40	4,0 mm	47332-40

KILLIAN
Ø 1,5 mm
47345-15

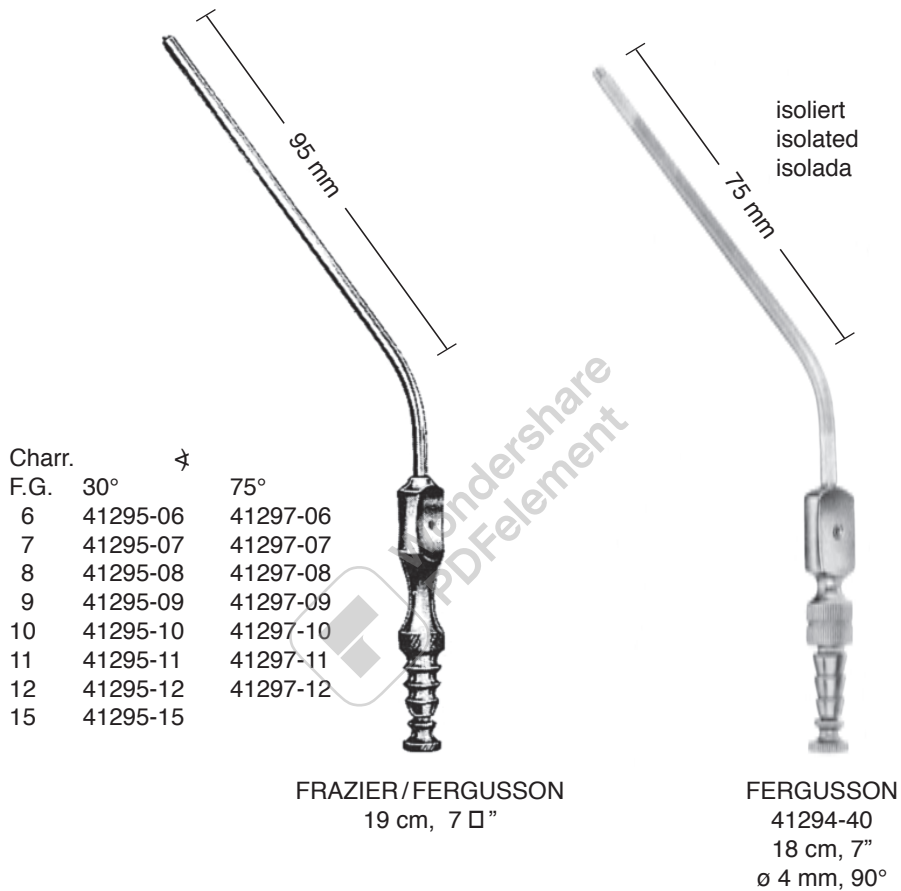
Saugkanülen
Suction Tubes
Cánulas aspiradoras

Saugrohre
Suction Tubes
Tubos de aspiración

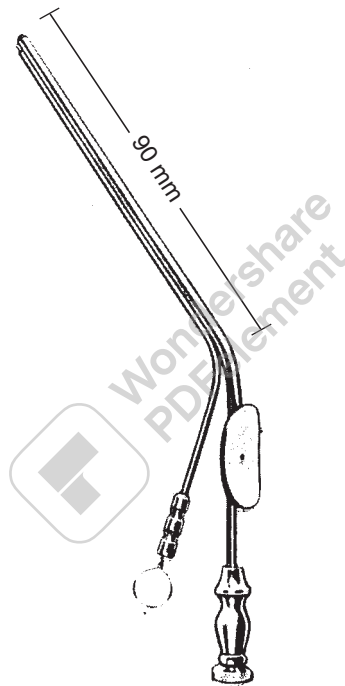

HOUSE
9 cm, 3 1/4"

41303-09	Ø 0,9 x 0,7 mm
41303-12	Ø 1,2 x 0,9 mm
41303-15	Ø 1,5 x 1,2 mm
41303-18	Ø 1,8 x 1,8 mm
41303-25	Ø 2,5 x 2,0 mm
41303-30	Ø 3,0 x 2,0 mm
41303-45	Ø 4,5 x 2,0 mm

Trokare
Trocars
Trócares

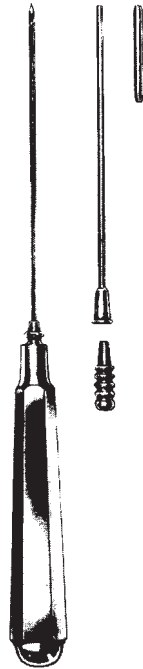

LICHTWITZ
23128-19 1,75 mm Ø

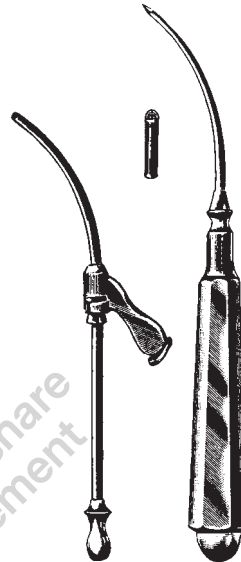

COAKLEY
23140-02 2,25 mm Ø

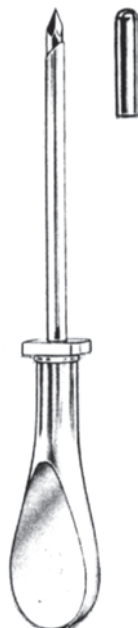

SINOSKOPIE TROKAR
Universal
8,5 cm, 3.4"

23181-40 für Optik mit Ø 4,0 mm
for optics Ø 4,0 mm
para la óptica de Ø 4,0 mm

Nasenmesser
Nasal Knives
Bisturios nasales



JOSEPH
16 cm, 6 1/4"



47370-16 47371-16
stumpf, blunt,
romos



47372-16 47373-16
spitz, pointed,
agudos



Wondershare
PDFelement



FREER
47374-16
16,5 cm, 6 1/4"



JOSEPH
47375-16
16,5 cm, 6 1/4"

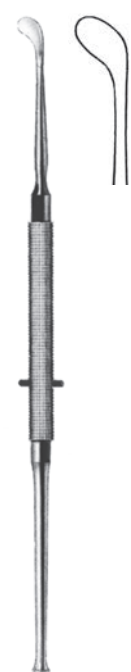

FREER
47375-19
19 cm, 7 1/4"

Nasenplastik- und Operationsmesser, Sichelmesser
Rhinoplastic and Nasal Knives, Septum Sickle Knives
Bisturías para plástica y operaciones de la nariz, Bisturías para el tabique nasal



JOSEPH
47376-16
16 cm, 6 1/4"

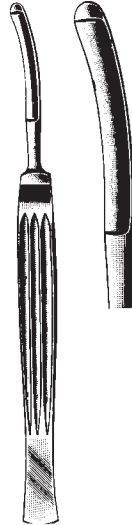

CONVERSE
47379-16
16 cm, 6 1/4"



COTTLE
47380-15
15 cm, 6"



COTTLE
47382-15
15 cm, 6"



JOSEPH
47384-15
15 cm, 6"



JOSEPH
47385-15
15 cm, 6"



Hadeo
19 cm, 7 1/4"



47386-01
spitz
pointed
agudo



47386-02
stumpf
blunt
romo

Schwingmesser
Septum Swivel Knives
Bisturios para el tabique nasal



BALLENGER
20 cm, 8"

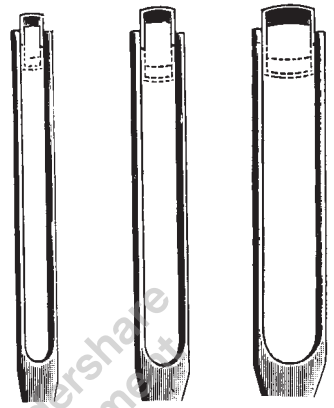

47390-03 3 mm 47390-04 4 mm 47390-05 5 mm

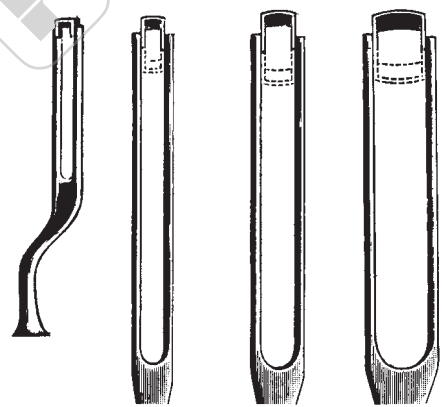

47392-03 3 mm 47392-04 4 mm 47392-05 5 mm

Submukosamesser, Knorpelritzmesser
Submucosa Knife, Cartilage Knife
Cuchillo para submucosa, Cuchillo para rajar cartílagos



FREER-INGALS
47372-17
17 cm, 6 1/8"



MASING
47377-13
13 cm, 5 1/8"

Dermatome
Dermátomos



SCHINK
07490-00
30 cm, 11 1/4"

compl.
mit/with/con
07490-01 (1) Stk./pcs
07490-02 (2) Stk./pcs



07490-01
Ersatzklinge
Spare blade
Hoja de repuesto

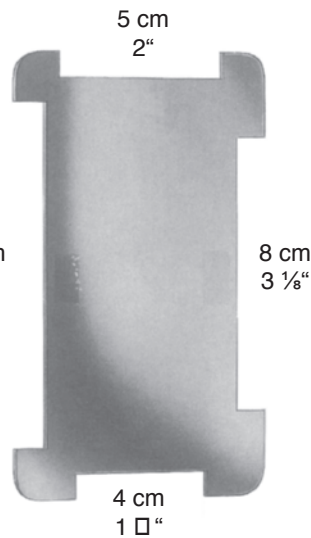

07490-02

Spannplatte
Skin straightening plate
Placa para extender la piel

Dermatome
Dermatome
Dermàtomos



HUMBY
07495-31
31 cm, 12 □“

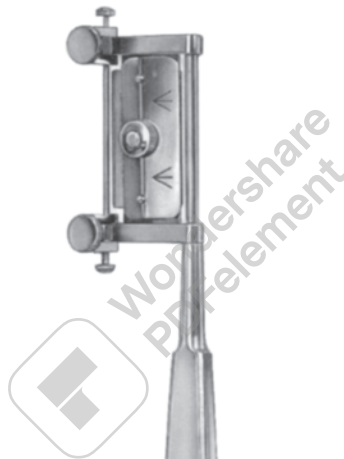

SILVER
07498-00
19 cm, 7 □“



WATSON
07499-00
30 cm, 11 □“

Ersatzklingen, unsteril / Spare blade, non sterile
Hoja de repuesto, no esteril

07496-31

07296-00

07499-01

Septum Elevatoren
Septum Elevators
Elevadores para el tabique



McKENY
15 cm, 6"



47410-04
4 mm



47410-05
5 mm



HALLE
47410-16
16,5 cm, 6 1/2"



JOSEPH
47411-16
16 cm, 6 1/4"



ROGER
47413-19
19 cm, 7 1/2"



5 mm



MASING
47414-21
21 cm, 8"



5 mm

Septum Elevatoren
Septum Elevators
Elevadores para el tabique



FREER
47415-18
18 cm, 7"

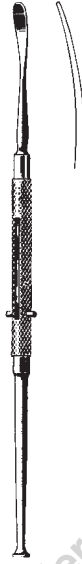

FREER
47417-19
19 cm, 7 1/4"

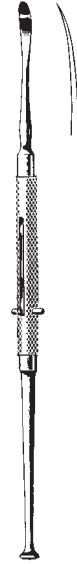

FREER
47419-19
19 cm, 7 1/4"



KILLIAN
47420-01
18,5 cm, 7 1/4"



PIERCE
47420-02
21 cm, 8 1/4"



SINUS
47420-03
18 cm, 7"

Septum Elevatoren
Septum Elevators
Elevadores para el tabique



PENNINGTON
47420-04
21 cm, 8 1/4"



McKENTY
47420-20
22 cm, 8 1/4"



HOWARTH
47421-21
21,5 cm, 8 1/4"



COTTLE
47421-23
23 cm, 9"



COTTLE JOSEPH
47422-22
22 cm, 8 1/4"



COTTLE
47423-22
22 cm, 8 1/4"

Septum Elevatoren
Septum Elevators
Elevadores para el tabique



COTTLE
47424-16
16 cm, 6 □"



COTTLE
47425-19
19 cm, 7 □"

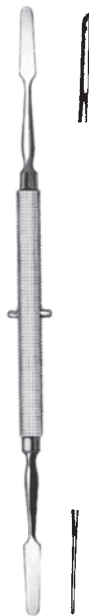

KILLIAN
47426-22
22 cm, 8 □"

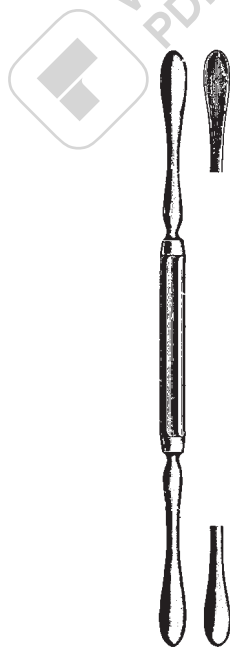

HAJEK-BALLENGER
47428-21
22 cm, 8 □"



BALLENGER
47430-22
22 cm, 8 □"

Elevatoren
Elevators
Elevadores

Nasenfraktur-Elevator
Nasal fracture elevator
Elevador para fracturas nasales

Septumfraktur-Elevator
Septum fracture elevator
Elevador para fracturas del tabique nasal

9 mm

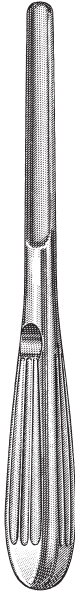

BOIES
33720-19
19 cm, 7 1/2"

6 mm



SEWALL
47412-20
20 cm, 8"

Antrum-Elevator
Antrum Elevator
Elevador para el antro



GOLDMANN
33720-20
20 cm, 8"

Raspatorien
Raspatories
Periostótomos



Osteotom mit Ferrozellgriff
Osteotome with Ferrozell-Handle
Osteótomo con mango de Ferrozell



LEXER
22 cm, 8 □"

Osteotome
Osteotomes
Osteotomo

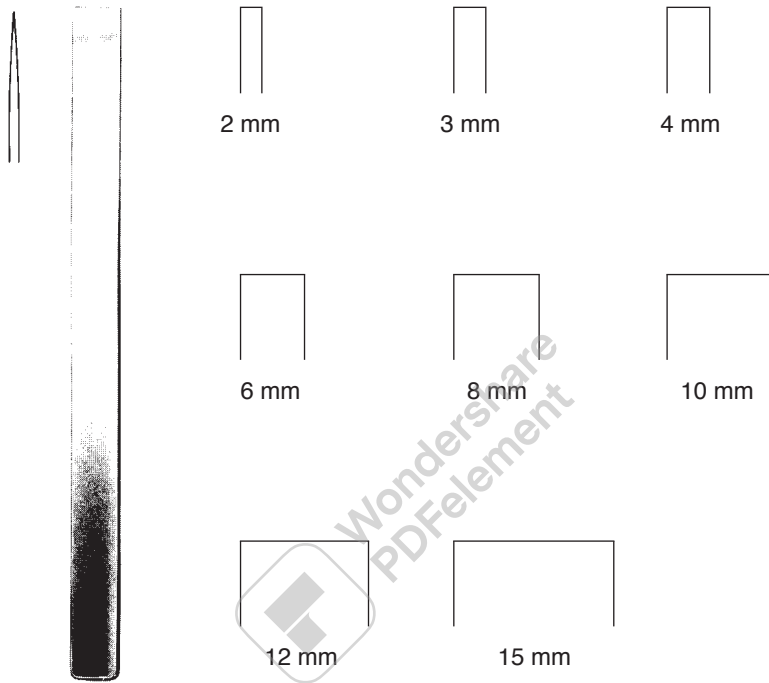

MINI-LAMBOTTE

12,5 cm, 5"	mm	17 cm, 6 1/2"
33654-02	2	33652-02
33654-03	3	33652-03
33654-04	4	33652-04
33654-06	6	33652-06
33654-08	8	33652-08
33654-10	10	33652-10
33654-12	12	33652-12
33654-15	15	33652-15

Septum Meißel
Rhinoplastic Chisels
Cinceles para la plàstica nasal

4 mm



FREER
47450-04
15 cm, 6"

4 mm



FREER
47451-04
15 cm, 6"

Septum Meißel
Rhinoplastic Chisels
Cinceles para la plástica nasal



COTTLE
18 cm, 7"



47454-04
4 mm



47454-07
7 mm



47454-09
9 mm



47454-12
12 mm

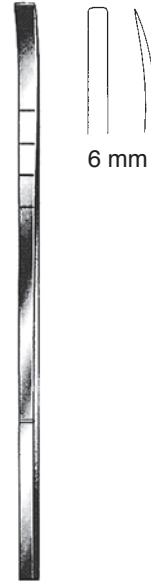

COTTLE
47455-06
18 cm, 7"



6 mm



COTTLE
18 cm, 7"



47458-04
4 mm



47458-07
7 mm



47458-09
9 mm



47458-12
12 mm



COTTLE
18 cm, 7"



47460-04
4 mm



47460-07
7 mm



47460-12
12 mm

Septum Meißel
Rhinoplastic Chisels
Cinceles para la plàstica nasal



FOMON
17 cm, 6 □"

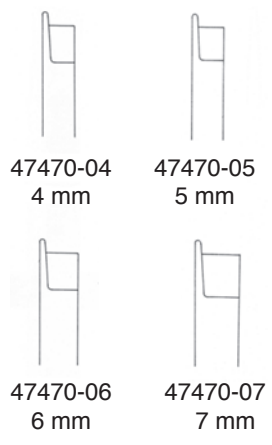

47470-04
4 mm

47470-05
5 mm

47470-06
6 mm

47470-07
7 mm



CINELLI
16 cm, 6 □"

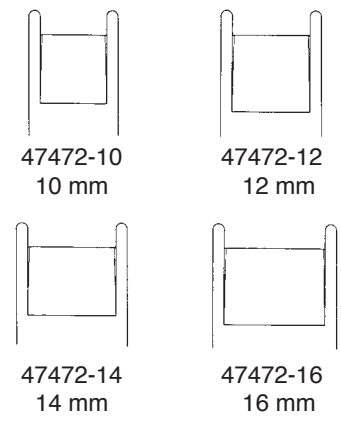

47472-10
10 mm

47472-12
12 mm

47472-14
14 mm

47472-16
16 mm



SHEEHAN
16 cm, 6 □"

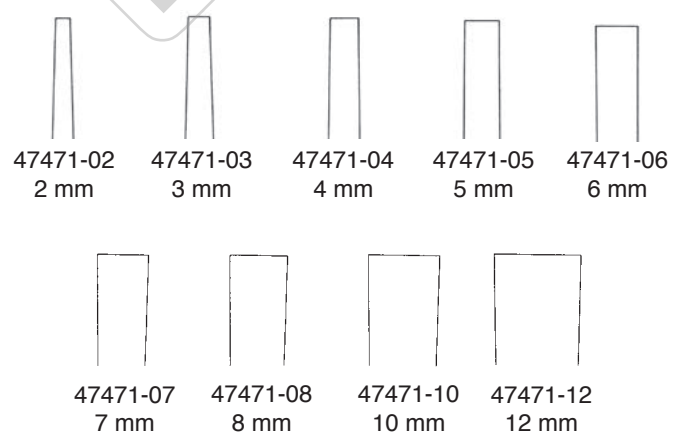

47471-02
2 mm

47471-03
3 mm

47471-04
4 mm

47471-05
5 mm

47471-06
6 mm

47471-07
7 mm

47471-08
8 mm

47471-10
10 mm

47471-12
12 mm

Septum Meißel, Osteotom
Rhinoplastic Chisels, Osteotomes
Cinceles para la plàstica nasal, Osteótomos

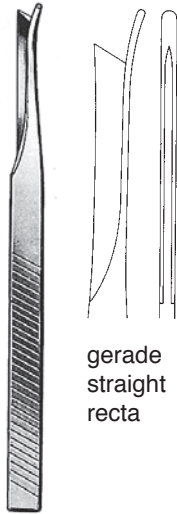

gerade
straight
recta

SILVER
47473-01
18 cm, 7"

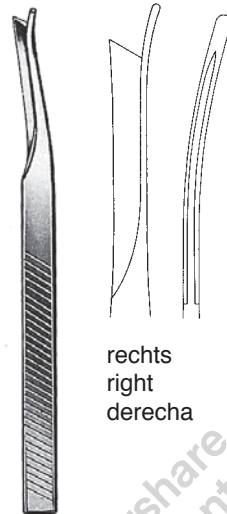

rechts
right
derecha

SILVER
47473-02
18 cm, 7"

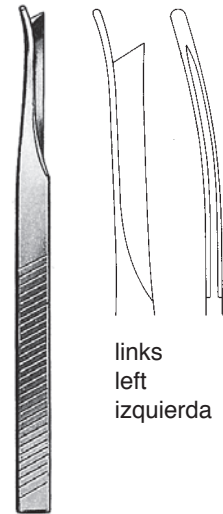

links
left
izquierda

SILVER
47473-03
18 cm, 7"



47474-03

gerade
straight
recta

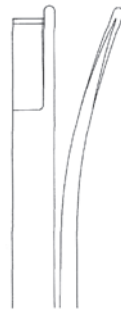

47474-01

rechts
right
derecha



47474-02

links
left
izquierda

NEIVERT-ANDERSON
20,5 cm, 8" 7 mm

Osteotome
Osteotomes
Osteotomos

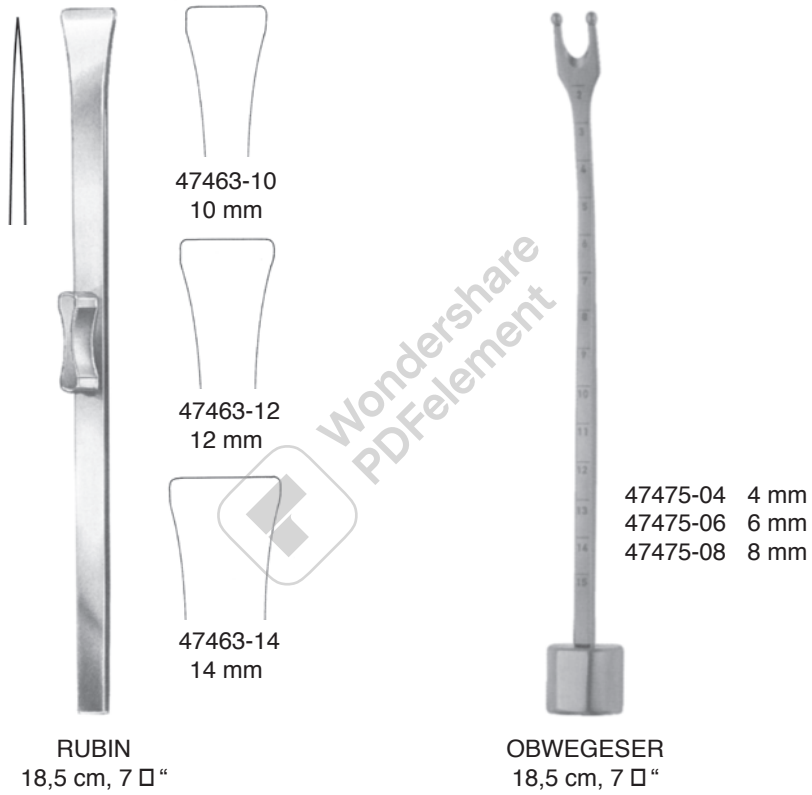

Meißel
Chisels
Cinceles

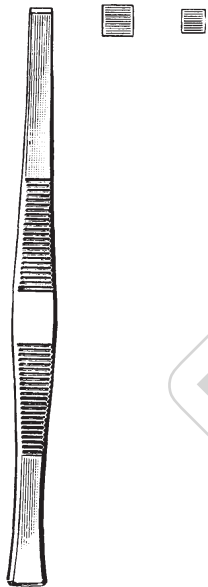

PASSOW
12 cm, 4 1/4"
33626-35 3,5 mm
33626-25 2,5 mm



47457-03
3,0 mm

47457-05
4,5 mm

WALTER
18 cm, 7"

Septum Meißel
Rhinoplastic Chisels
Cinceles para la plàstica nasal



KILLIAN-CLAUS
47482-05
17 cm, 6 □"



HAJEK
16 cm, 6 □"

- 47484-04 4 mm
- 47484-06 6 mm
- 47484-08 8 mm



WEST
47486-16
16 cm, 6 □"



WEST
47487-16
16 cm, 6 □"



FREER
47489-16
16 cm, 6 □"

Knorpelquetscher
Cartilage Crusher
Machacadora de cartilago



COTTLE
47461-00 7,5 cm, 3"

Nasenraspeln
Nasal Rasps
Escofinas nasales



JOSEPH
47502-16 16 cm, 6 □"



MALTZ
47504-18 18 cm, 7"

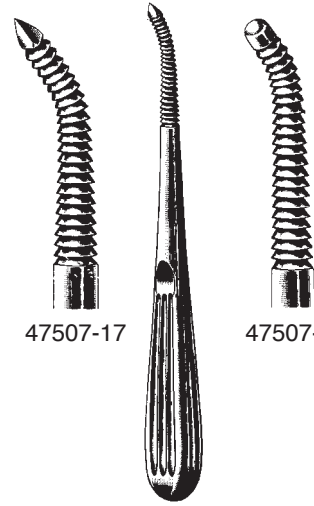

47507-17

47507-18

WIENER
18 cm, 7"



diamantiert
with diamond coating
con boca de diamante

PEET
47523-01 19 cm 7 □" 47523-02



GLABELLA
47524-01 21 cm, 8 □"

47525-20
fein, 20 Zähne
fine, 20 teeth
fina, 20 dientes



47526-20
grob, 11 Zähne
coarse, 11 teeth
gruesa, 11 dientes

PARKES
21 cm, 8 □"

Nasenraspeln
Nasal Rasps
Escofinas nasales

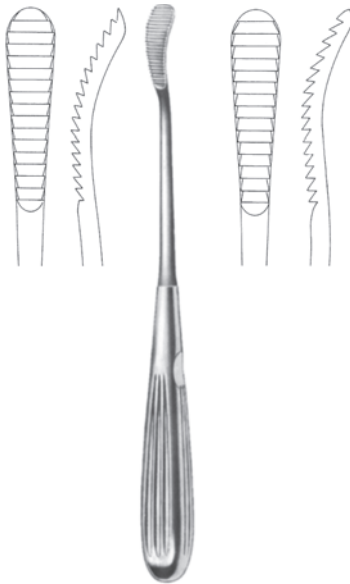

AUFRICHT
47511-21 21 cm, 8 1/4" 47513-21

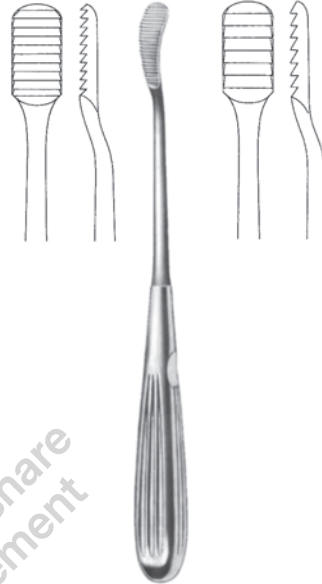

JOSEPH (LEWIS)
47514-16 18 cm, 7" 47516-16

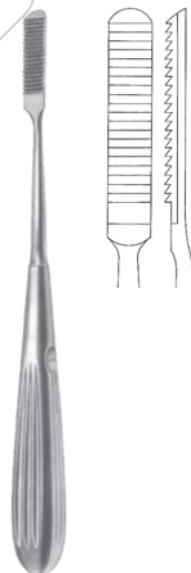

MALTZ (COTTLE)
47518-21 21 cm, 8 1/4"

Nasenraspel
Nasal Rasp
Escofina nasal

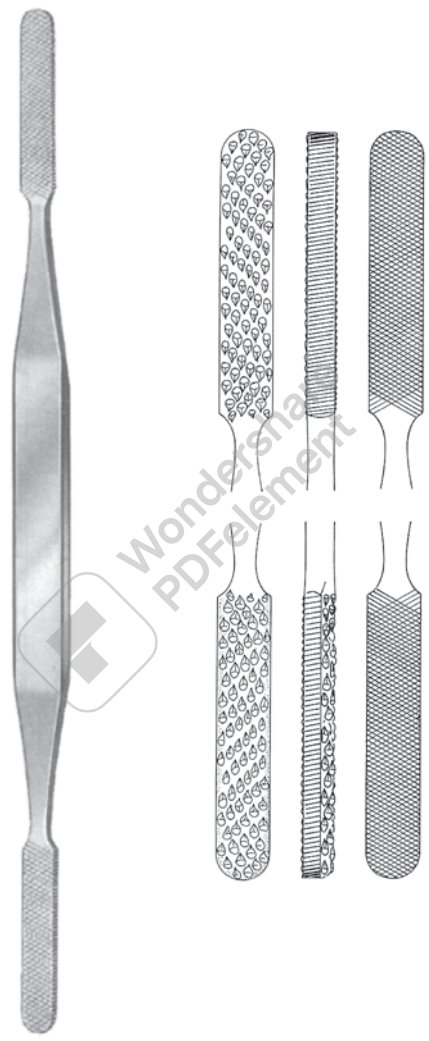

FOMON
47520-21
21 cm, 8 □“

Nasenraspeln
Nasal Rasps
Escofinas nasales

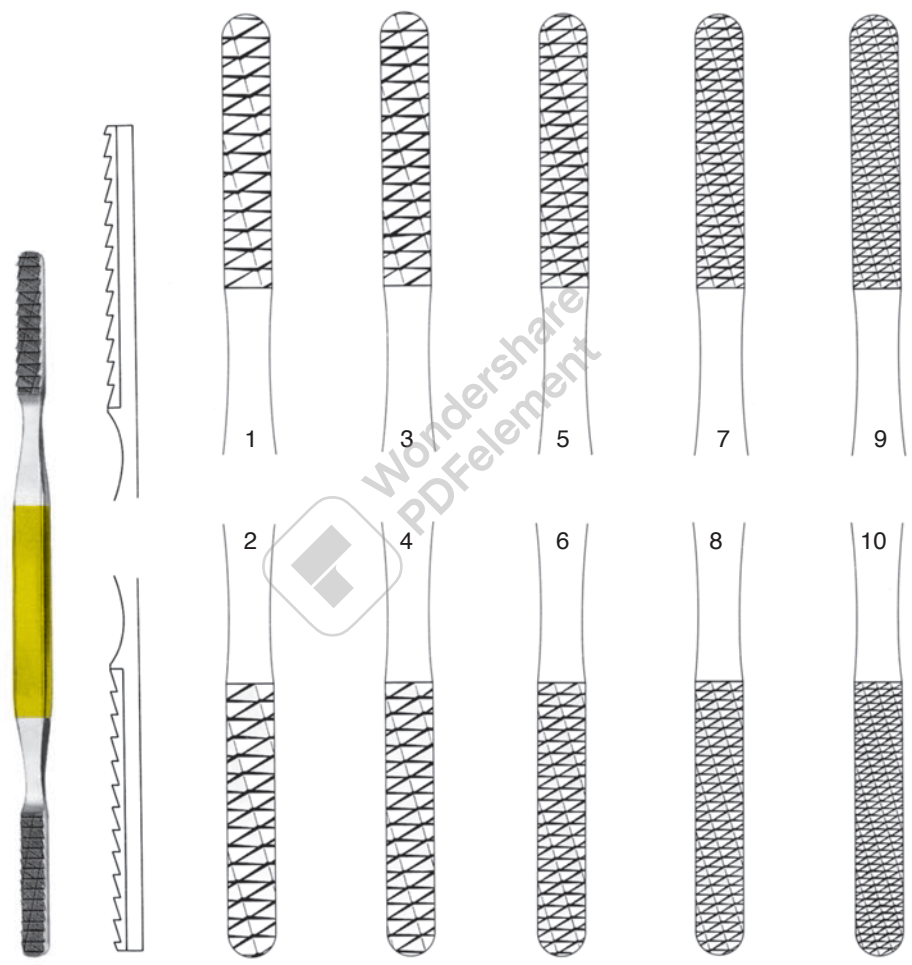

FOMON
20 cm, 8"

Fig. 1/2
47522-01 TC

Fig. 3/4
47522-04 TC

Fig. 5/6
47522-05 TC

Fig. 7/8
47522-07 TC

Fig. 9/10
47522-09 TC

Nasenraspeln
Nasal Rasps
Escofinas nasales

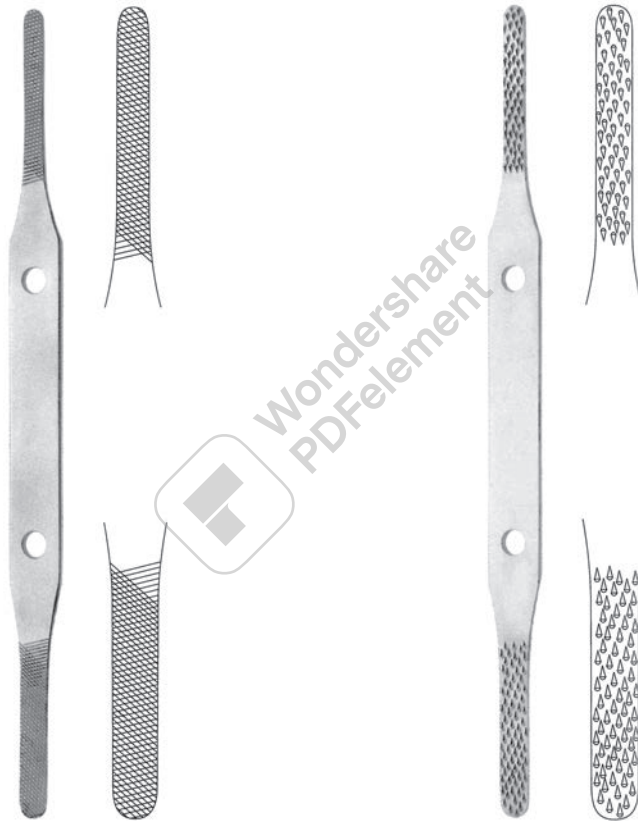

MASING
47528-01
21 cm, 8 □“

MASING
47528-02
21 cm, 8 □“

Nasenraspeln
Nasal Rasps
Escofinas nasales

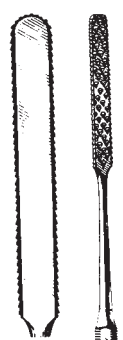

Fig. 1
47526-16



Fig. 2
47527-16

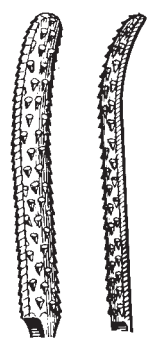
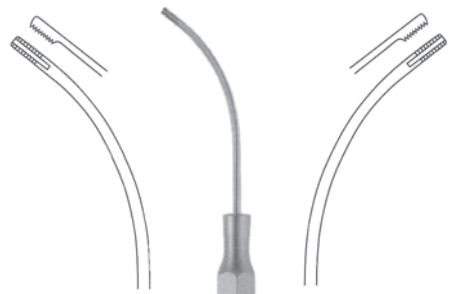

Fig. 3
47529-16



GALLAHER
16 cm, 6 □"

Nasenraspeln, Nasensägen
Nasal Rasps, Nasal Saws
Escofinas nasales, Sierras nasales



47530-01
Fig. 1

47530-02
Fig. 2



DINGMAN Set
47530-00
15 cm, 6"

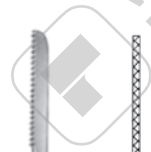

JOSEPH
19 cm, 7 1/2"



47533-19
gerade
straight
recta

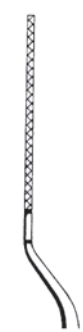

47532-19
links
left
izquierda

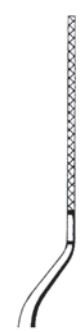

47534-19
rechts
right
derecha

Nasensägen
Nasal Saws
Sierras nasales



JOSEPH
47535-01 17 cm, 6" 47535-02



LINDEMANN
47535-20 20 cm, 8"

Feine Wundhäkchen
Fine Retractors
Ganchos finos

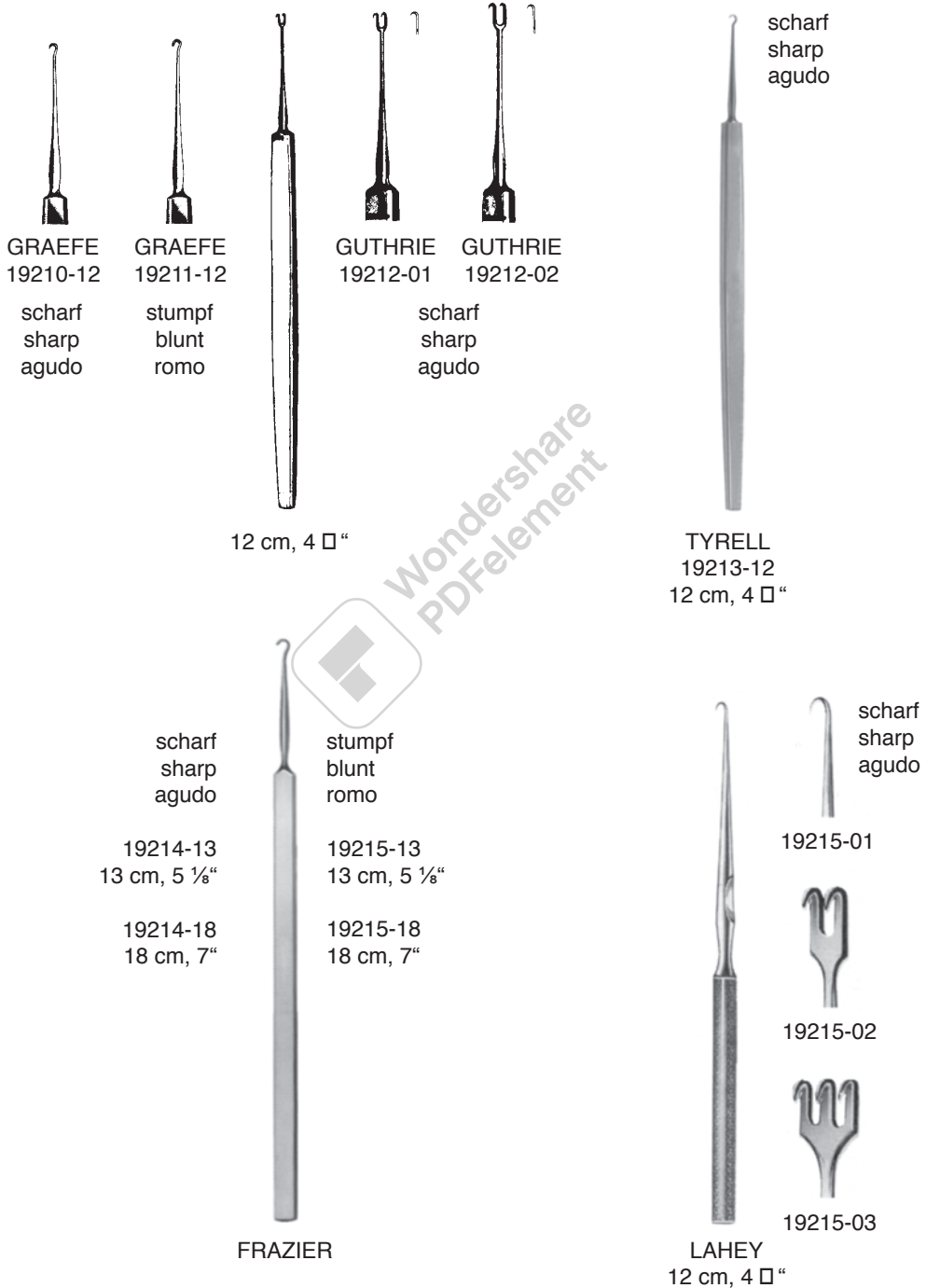

Feine Wundhäkchen
Fine Retractors
Ganchos finos



JOSEPH
16 cm, 6 1/4"



19216-01
1 mm

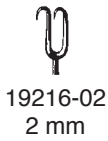

19216-02
2 mm



19216-05
5 mm



19216-07
7 mm



19216-10
10 mm



KLEINERT-KUTZ
13 cm, 5 1/8"



19217-03



19217-05



19217-07

Feine Wundhäkchen
Fine Retractors
Ganchos finos

3 mm



BARSKY
19218-01
15 cm, 6"

3 mm



BARSKY
19218-02
15 cm, 6"

3 mm



HUMBY
19218-11
11,5 cm, 4 1/2"

Feine Wundhäkchen
Fine Retractors
Ganchos finos

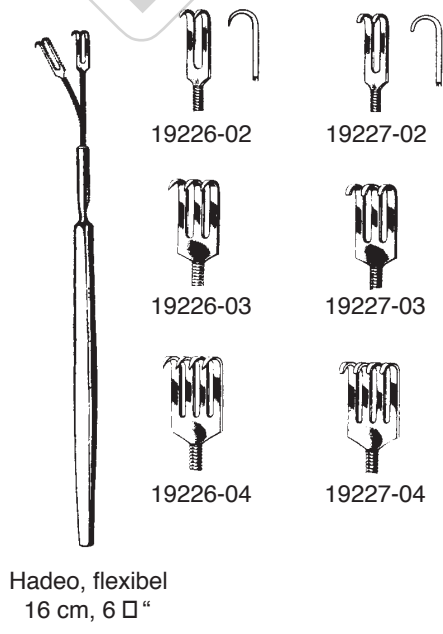
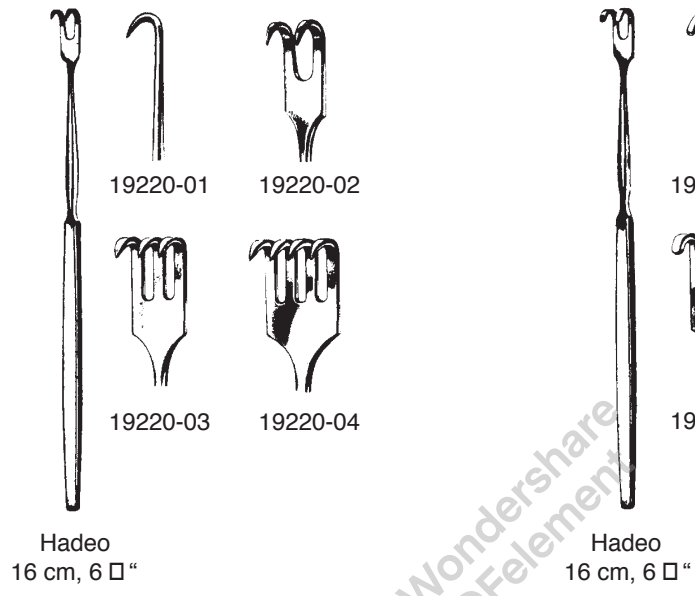

Feine Wundhäkchen
Fine Retractors
Ganchos finos



spitz
sharp
agudo

ROLLET
43376-13
13,5 cm, 5 1/8"



stumpf
blunt
romo

KNAPP
43377-13
13 cm, 5 1/8"



LUCAE
14 cm, 5 1/2"



45193-01
2 mm



45193-02
3 mm



45193-03
4 mm



BERGMANN
47569-14
14 cm, 5 1/2"

Nasenhaken
Nasal Retractor
Retractores nasales



COTTLE
47540-16
16 cm, 6 □"



MASING
47541-14
14 cm, 5 □"



AUFRICHT
47542-12
12 cm, 4 □"



AUFRICHT
47551-16
16 cm, 6 □"



AUFRICHT
47551-16CL
16 cm, 6 □"



MASING-NEIVERT
47552-16
20 cm, 8 □"

Nasenflügelhäkchen
Alar Retractor
Gancho para las alas de la nariz

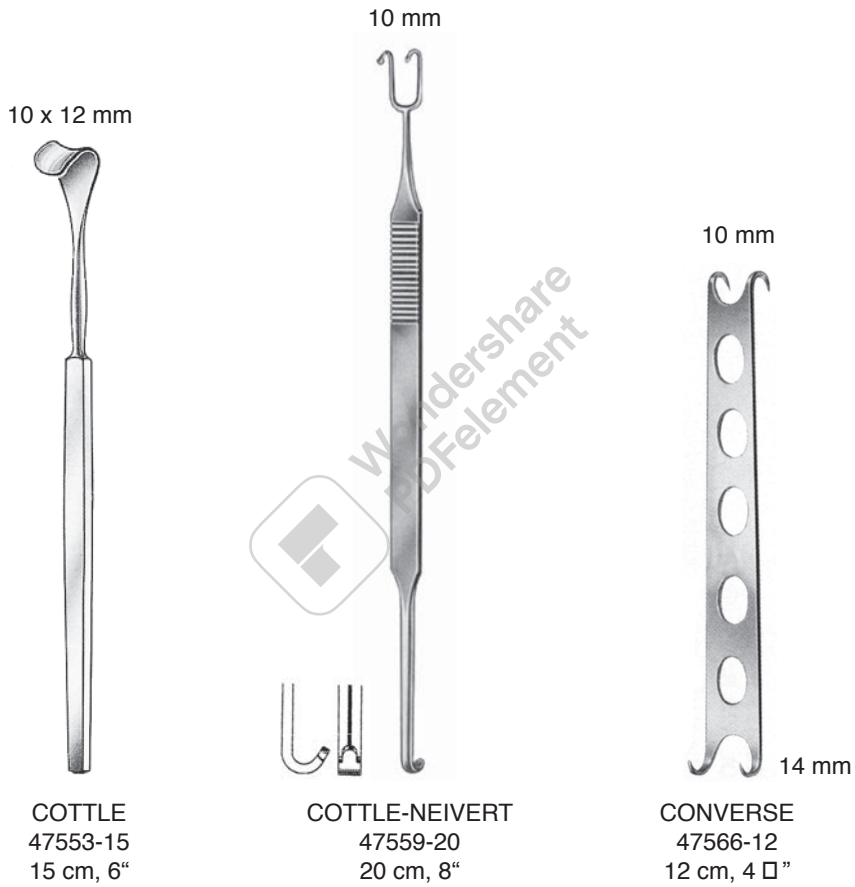

Nasenflügelhäkchen
Alar Retractor
Gancho para las alas de la nariz

10 mm



COTTLE
14,5 cm, 5 1/4"

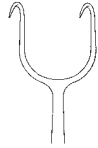

47554-01

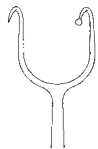

47554-02



47554-03

3 x 11 mm



KILNER
47555-08
8 cm, 3 1/8"

10 mm



FOMON
47556-16
16 cm, 6 1/4"



FOMON
47557-17
17 cm, 6 3/4"

Feine Wundhäkchen
Fine Retractors
Ganchos finos



FREER
47558-15
15 cm, 6"



Fig. 1
47560-18

Fig. 2
47562-18

GILLIES
18 cm, 7"



COTTLE
47564-16
16 cm, 6 1/4"

Choanahaken, Fingerringhäkchen
Choana Hook, Retractor with Finger Ring
Gancho para coanas, Ganchito con anillo



LANGE
47563-22
23 cm, 9"

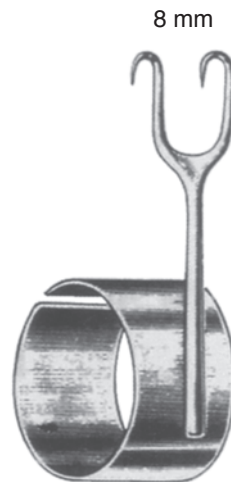

COTTLE
47568-08

Antrumküretten
Antrum Curettes
Curetas para el antro



47387-01
vorwärts schneidend
forward cutting
corte hacia adelante



47387-02
rückwärts schneidend
backward cutting
corte hacia atras

ANTRUM
19 cm, 7 1/2"

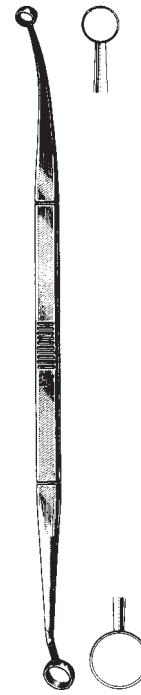

FAULKNER
47601-21
21 cm, 8 1/2"



COAKLEY
17 cm, 6 1/2"



47607-01
Fig. 1



47607-02
Fig. 2



47607-03
Fig. 3



47607-04
Fig. 4



47607-05
Fig. 5



47607-06
Fig. 6

Antrum Kürette, Antrumlöffel
Antrum Curettes
Cucharillas para antro

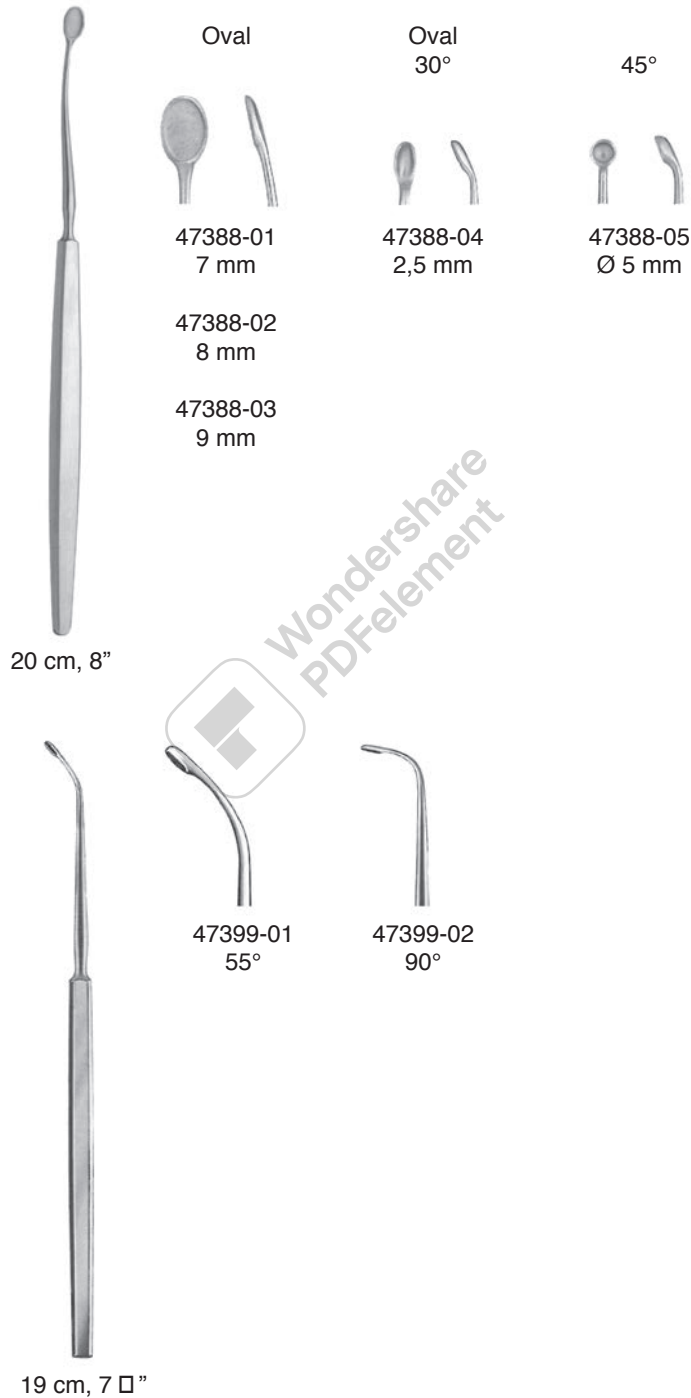

Scharfe Löffel
Bone Currettes
Cucharillas cortantes

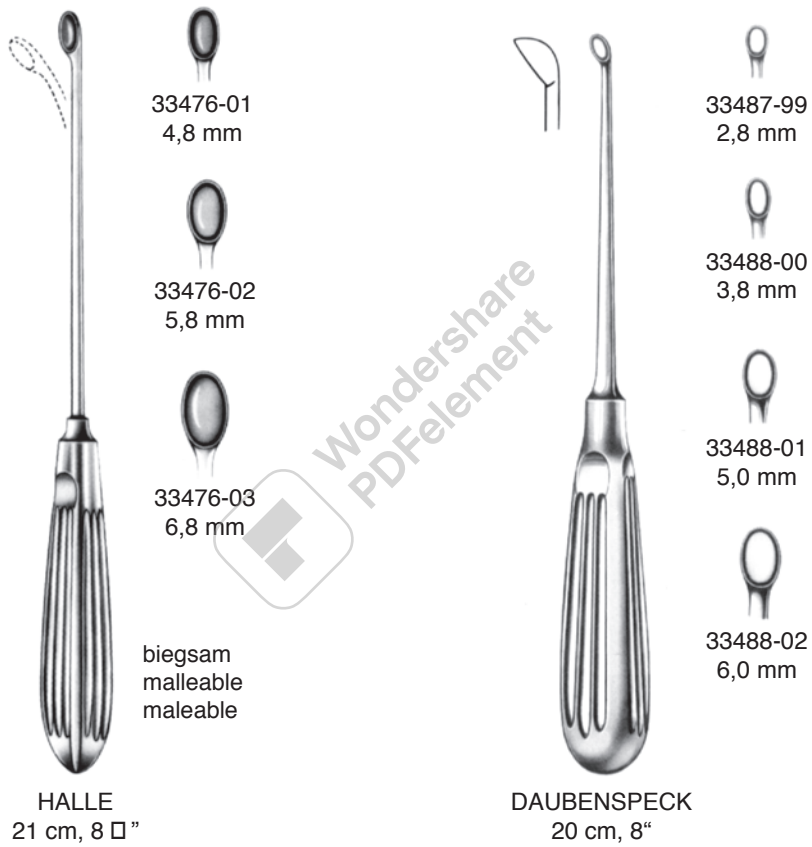

Hämmer
Bone Mallets
Martillos

Ø 25 mm



GERZOG
33686-25
18 cm, 7" 250g

Ø 25 mm



33694-01 18,5 cm, 7 □", 135 g
33694-03 Ersatzbacken
Nylon Caps
Tapas de repuesto

Ø 25 mm



33694-02 18,5 cm, 7 □"
1 Nylonbacke
1 Nylon Cap
1 tapa de nylon

Ø 20 mm



MEAD
33693-32
17 cm, 6 □" 320 g

Hämmer
Bone Mallets
Martillos

Ø 42 mm

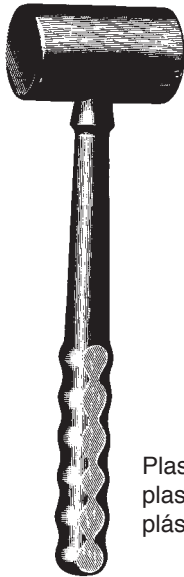

Plastik
plastic
plástico

33695-40
26 cm, 10 1/4"
400 g

Ø 12 mm



QUISLING
33696-75
17 cm, 6 3/4"

Ø 22 mm



PARTSCH
33698-98
18 cm, 7" 199 g

Ø 30 mm



COTTLE
33700-05
18 cm, 7" 240 g

Nasensonde, Dilatatoren
Nasal Probe, Dilators
Sondas nasales, Diladores



RITTER-HALLE
16 cm, 6 1/4"
47342-25 Ø 2,5 mm
47342-30 Ø 3,0 mm
47342-40 Ø 4,0 mm



SINUS
47420-03
18 cm, 7"



FRONTAL
47427-21
21 cm, 8 1/4"
Ø 1,2 mm
Ø 1,5 mm



WILDER
43602-01



WILDER
43602-02



WILDER
43602-03

Sonden
Probes
Sondas

geknöpft
buttoned
abotonada



rostfrei
stainless steel
acero inoxidable

Fig.	BOWMAN	Ø mm
0000/000	43613-00	0,6/0,7
00/0	43614-00	0,7/0,8
0/1	43614-01	0,8/0,9
1/2	43614-12	0,9/1,1
2/3	43614-23	1,1/1,3
3/4	43614-34	1,3/1,4
4/5	43614-45	1,4/1,5
5/6	43614-56	1,5/1,6
6/7	43614-67	1,6/1,8
7/8	43614-78	1,8/1,9

Wundhaken
Retractors
Separadores

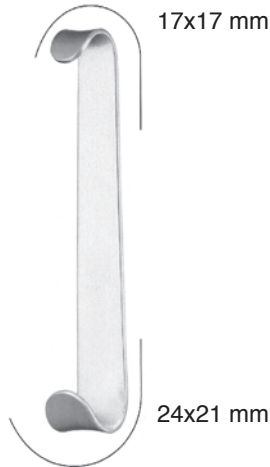

ROUX BABY
19122-13
13 cm, 5 1/8"

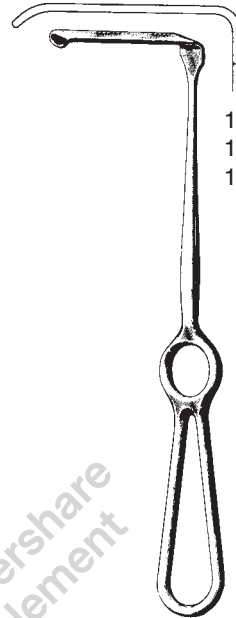

19314-07 35x 7 mm
19314-14 70x14 mm
19314-20 60x20 mm

KOCHER-LANGENBECK
21 cm, 8 1/4"

19344-14
14x17 mm
21,5 cm, 8 1/2"

19344-20
20x22 mm
22 cm, 8 3/4"

19344-26
26x30 mm
23,5 cm, 9 1/4"



MIDDELDORPF



Kieferhöhlenhaken
Antrum Retractor
Separador para antro

BRÜNING-SBRUNK
19499-00 19 cm, 7 1/2"

Wundspreizer
Self-retaining Retractors
Separadores autoestáticos

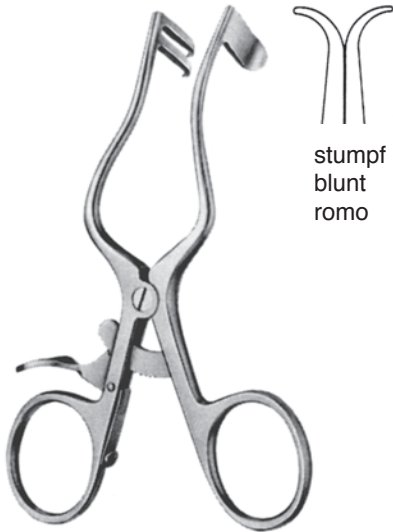

stumpf
blunt
romo

PLESTER
19672-11
11 cm, 4 3/8"

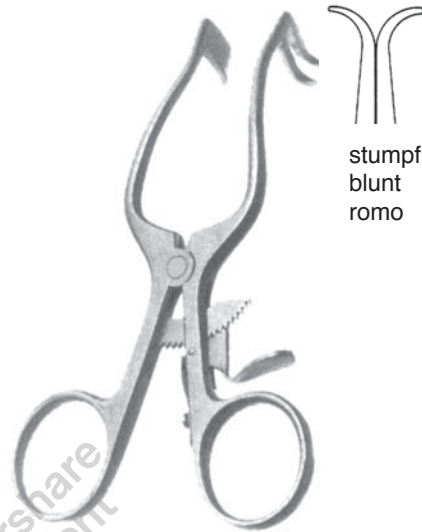

stumpf
blunt
romo

PLESTER
19673-11
11 cm, 4 3/8"



2x2

scharf
sharp
agudo

PLESTER
19677-10 10 cm, 4"
19677-13 13 cm, 5 1/8"

Wundspreizer
Self-retaining Retractors
Separadores autoestáticos



FISCH
19690-17
17 cm, 6 □“



FISCH
19691-17
17 cm, 6 □“



ADENOTOMIE UND
TONSILLEKTOMIE

ADENOTOMY AND
TONSILLECTOMY

ADENOTOMÍA Y
TONSILECTOMÍA



Wondershare
PDFelement

HADEO
INSTRUMENTE GERMANY

Indikationen und Kontraindikationen finden Sie in der entsprechenden Gebrauchsanweisung!
Indication and Contraindication please refer to our user's manual!
Indicaciones y Contraindicaciones se encuentran en la instrucciones de uso correspondientes!

Zungenspatel, Wangen- und Lippenhalter
Tongue Depressors, Cheek and Lip Retractors
Baja-lenguas, Separadores para labios y mejillas



Holz
wood
madera

49102-16
16 cm, 6 1/4"
Pack. à 100

19 mm



23 mm

KROENIG
49104-15
15 cm, 6"

23 mm

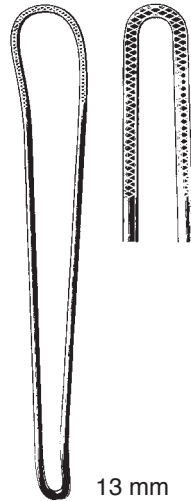

13 mm

FRENZEL
49105-16
16,5 cm, 6 1/2"

16 mm



49106-01
14,5 cm, 5 3/4"

15 mm



19 mm

BRUENINGS
49107-19
19 cm, 7 1/2"

20 mm



20 mm

CAWOOD-MINNESOTA
49108-15
15 cm, 6"

23 mm

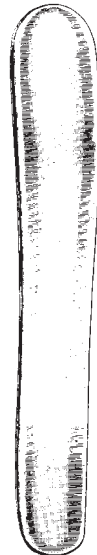

19 mm

BUCHWALD
49109-19
19 cm, 7 1/2"

Zungendrücker
Tongue Depressors
Baja-lenguas



MORITZ-SCHMIDT
49110-19
19 cm, 7 1/2"



HARTMANN
49111-15
15 cm, 6"



49115-01
Fig. 1
14 cm, 5 1/2"



49115-02
Fig. 2
15 cm, 6"

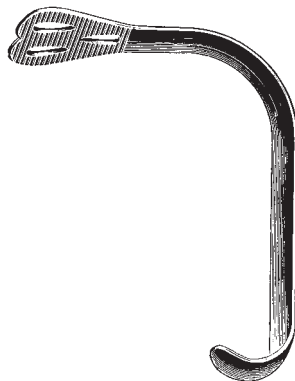

WIEDER
49115-01 - 49115-02

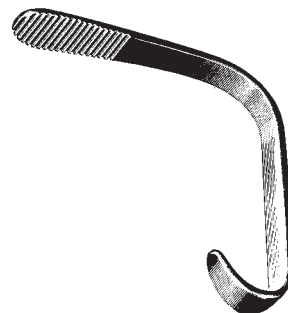

ANDREW
49117-11
11 cm, 4 3/8"

Zungendrucker, Wangen- und Lippenhalter, Zungenzangen
Tongue Depressor, Cheek and Lip Retractor, Tongue Holding Forceps
Baja-lenguas, Separadores para labios y mejillas, Pinza tira-lenguas



TOBOLD
49119-14
14,5 cm, 5 □"

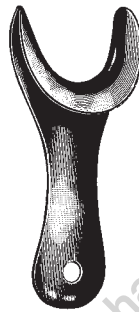

49230-11
11 cm, 4 3/8"



STERNBERG
49231-12 12 cm, 4 □"
49231-14 14 cm, 5 □"
49231-16 16 cm, 6 □"



49235-19
19 cm, 7 □"

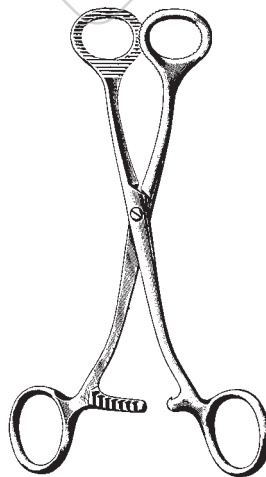

COLLIN
49250-16 16 cm, 6 □"
49250-18 18 cm, 7"

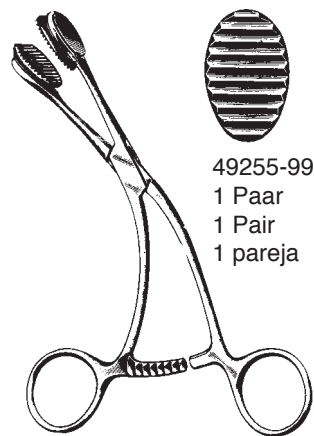

YOUNG
49255-16
16 cm, 6 □"

49255-99
1 Paar
1 Pair
1 pareja

Mundsperrer
Mouth Gags
Abre-Bocas

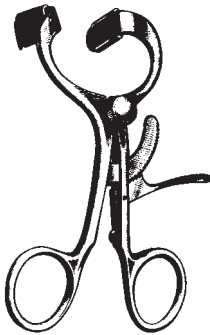

DOYEN-JANSEN (MOLT)
49265-12
12 cm, 4 1/4"

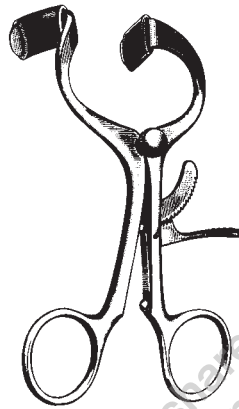

DOYEN-JANSEN (MOLT)
49265-14
14 cm, 5 1/4"

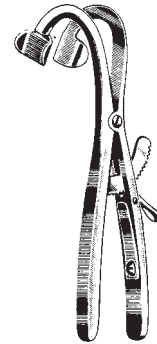

DENHART
49267-12
12 cm, 4 1/4"

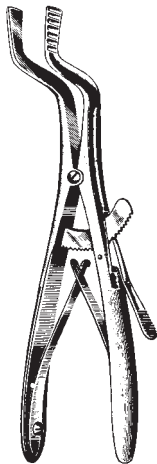

ROSER-KOENIG
49270-16 16 cm, 6 1/4"
49270-19 19 cm, 7 1/4"

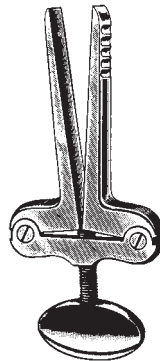

HEISTER
49272-13
13 cm, 5 1/8"

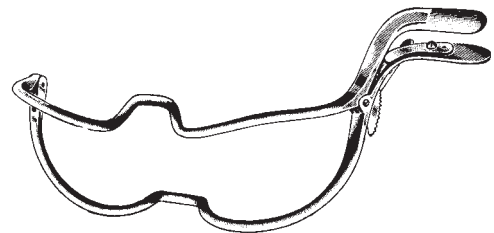

JENNINGS
49274-09 9 cm, 3 1/4"
49274-11 11 cm, 4 3/8"
49274-13 13 cm, 5 1/8"
49274-15 15 cm, 6"

Zungenspatel
Tongue Depressor
Baja-lengua

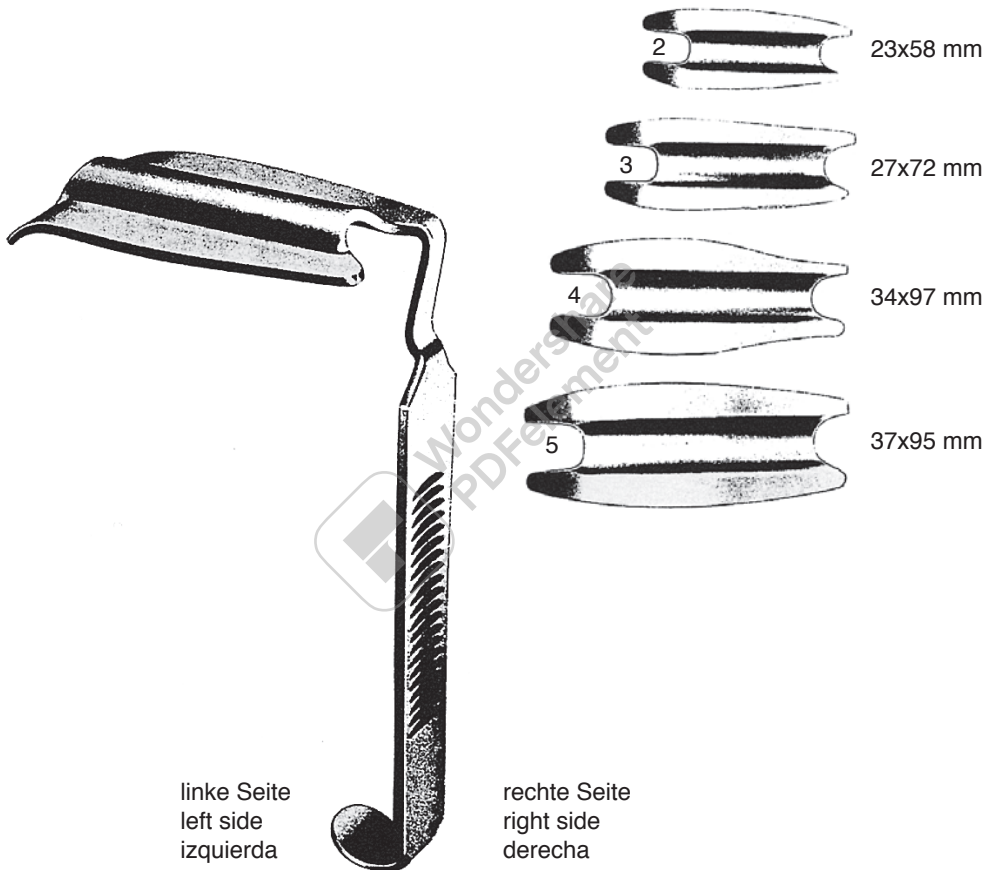

linke Seite
left side
izquierda

rechte Seite
right side
derecha

49287-02
49287-03
49287-04
49287-05

RING
Fig. 2
Fig. 3
Fig. 4
Fig. 5

49288-02
49288-03
49288-04
49288-05

Zungenspatel
Tongue Depressor
Baja-lengua

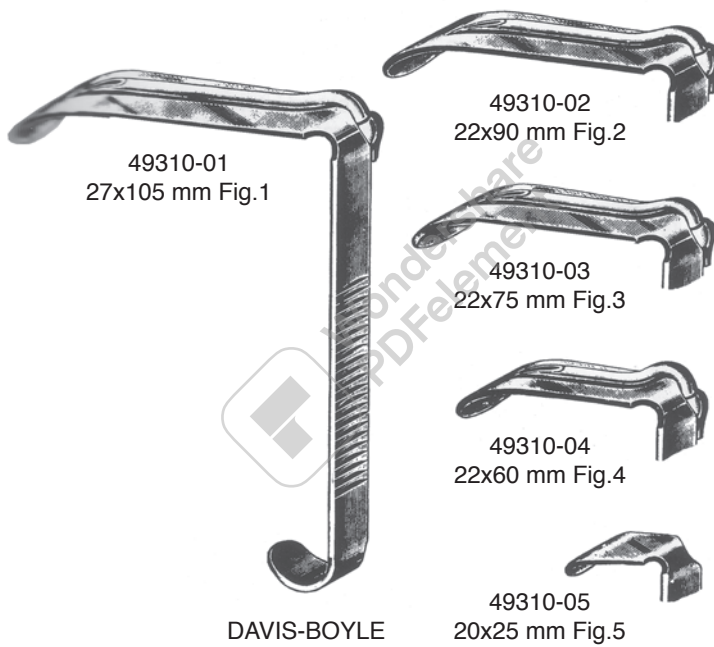

Mundsperrer
Mouth Gags
Abre-Bocas



	für Erwachsene for adults para adultos	für Kinder for children para niños
links left izquierda	49310-10	49310-11
rechts right derecha	49310-12	49310-09

Mundsperrer
Mouth Gag
Abre-Bocas



49315-01
37 x 80 mm
Fig. 1

49315-02
32 x 75 mm
Fig. 2

KILNER-DOUGHTY
49315-00
compl.

49315-03
28 x 65 mm
Fig. 3

49315-10
Sperrer allein
Mouth Gag only
Abre-boca suelto

Mundsperrer
 Mouth Gag
 Abre-Bocas

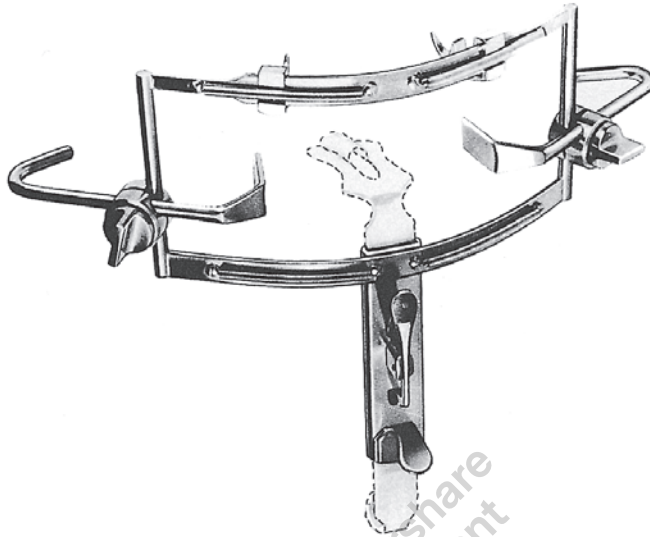

DINGMANN
 49317-10
 Sperrer allein / Mouth Gag only
 Abre-boca suelto



1 24x62 mm
 49317-01

49317-00 DINGMANN, compl.

mit 3 auswechselbaren Zungendrucker,
 2 seitliche Wangenhaken und 2 Zahnhaken

with 3 interchangeable tongue depressors,
 2 rotating cheek holders
 2 movable tooth hooks and thread guide



2 28x65 mm
 49317-02

con 3 baja-lenguas intercambiables,
 2 valvas giratorias p. los labios,
 2 ganchos graduables

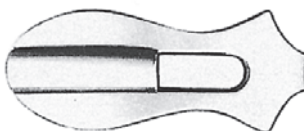

3 31x75 mm
 49317-03

Mundsperrer, Gaumenplatte
Mouth Gags, Palate Blade
Abre-Bocas, placa para el paladar

49320-20
Silikon-Schlauch
Silicone Tubing
tubo de silicona

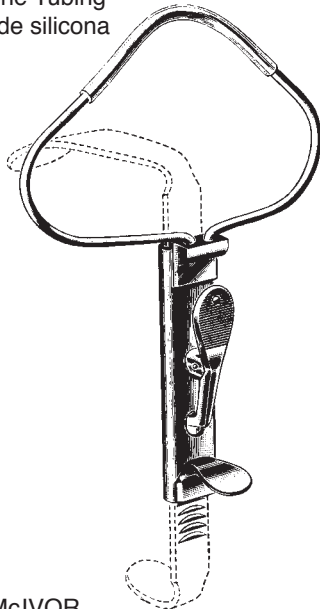

McIVOR
49320-00
compl.

49320-10

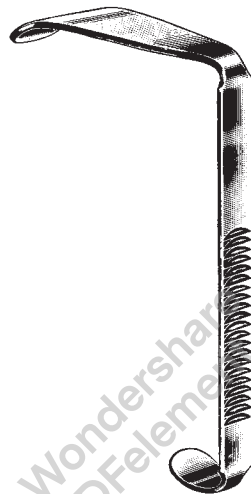

49320-01
27x95 mm Fig. 1

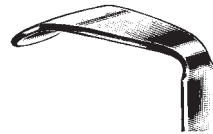

49320-02
22x85 mm Fig. 2

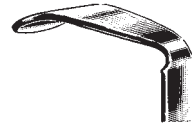

49320-03
22x70 mm Fig. 3



DAVIS-MEYER
49340-00



49341-00

Zungenspatel
Tongue Blades
Baja-lenguas



Zungenspatel
Tongue Blades
Baja-lenguas

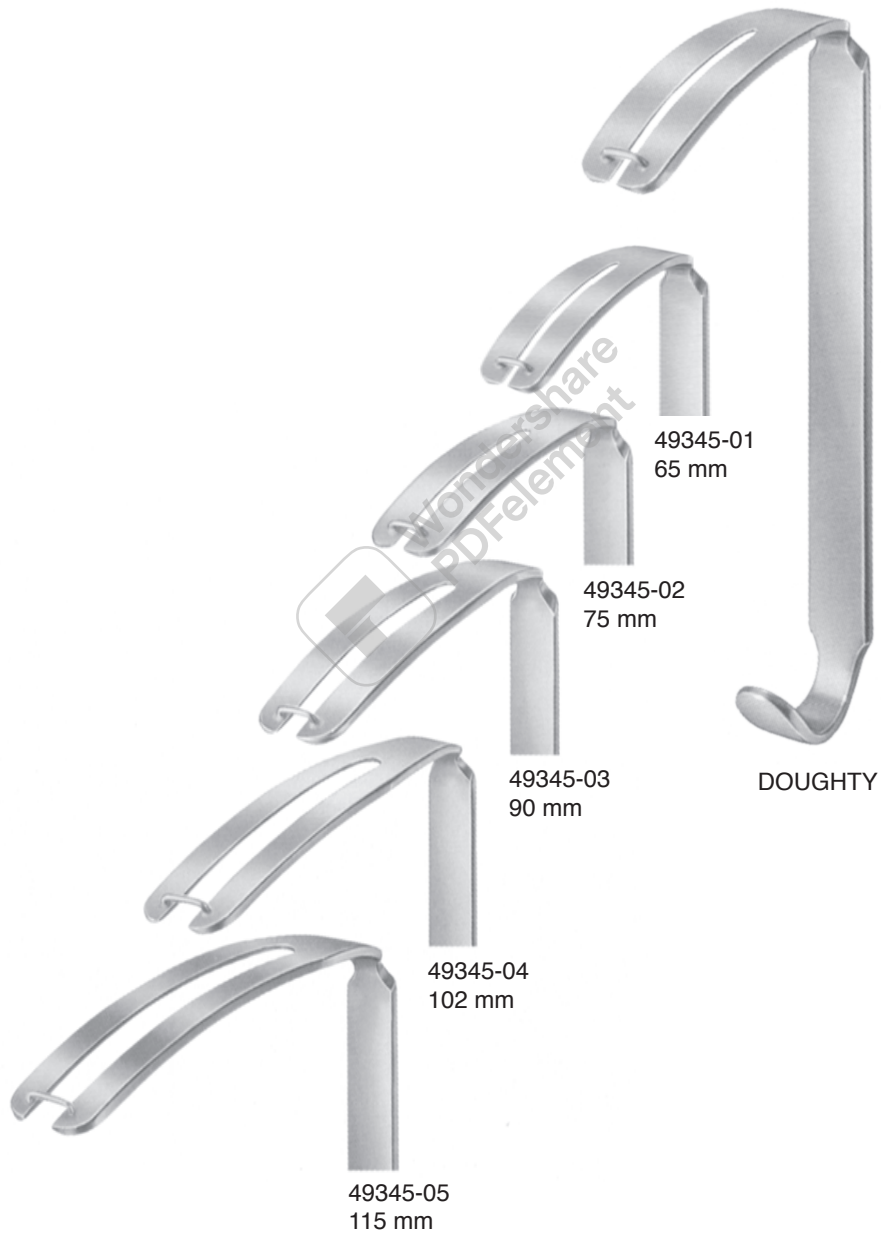

Mundkeil, Bruststütze
Oral Wedges, Chest Support
Abre-Bocas, Soporte de pecho

Holz
wood
madera



MAUNDER
49360-10



NEGUS
49400-01

Tonsillenzangen
Tonsil Forceps
Pinzas para coger las amígdalas

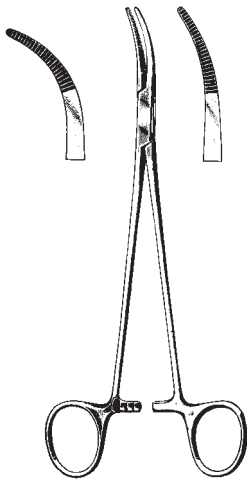

19 cm, 7 1/2"
SAWTELL SCHNIDT
51181-19 51183-19

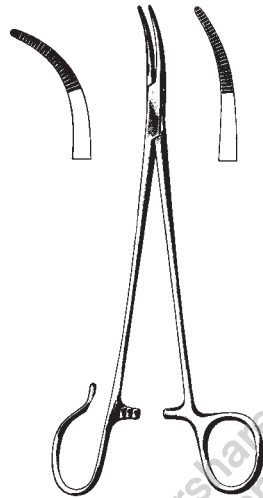

19 cm, 7 1/2"
SAWTELL SCHNIDT
51185-19 51187-19

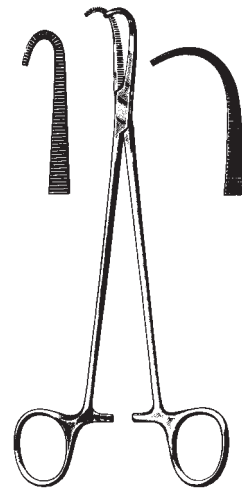

19 cm, 7 1/2"
NEGUS NEGUS
51191-19 51193-19

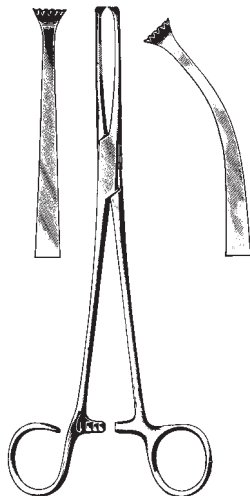

19 cm, 7 1/2"
COLVER
51202-19 51203-19

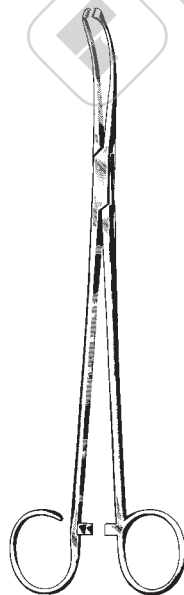

WHITE
51205-18 18 cm, 7"
51205-23 23 cm, 9"

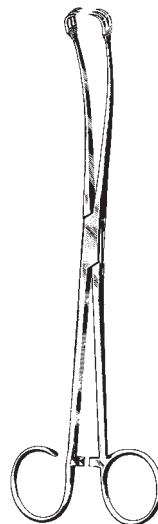

BALLENGER
51207-21
21,5 cm, 8 1/2"

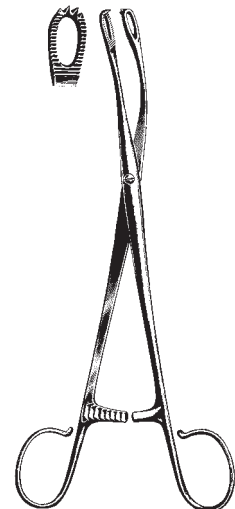

BLOHMKE
51209-20
20 cm, 8"

Tonsillenzangen, Tonsillenpinzette
Tonsil Forceps
Pinzas para amígdalas



ABRAHAM
51210-20
20 cm, 8"

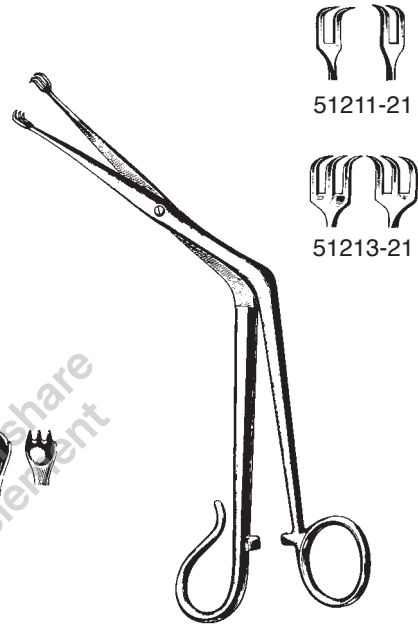

51211-21

51213-21

TYDING
21 cm, 8 1/4"

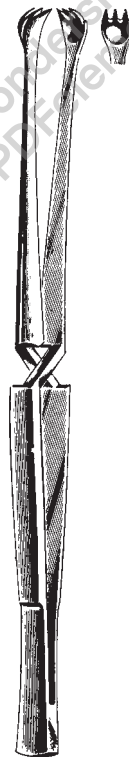

MARSCHIK
51219-22
22 cm, 8 1/2"

Tonsillenklemme, Tonsillenzange
Tonsil Forceps
Pinzas para amígdalas

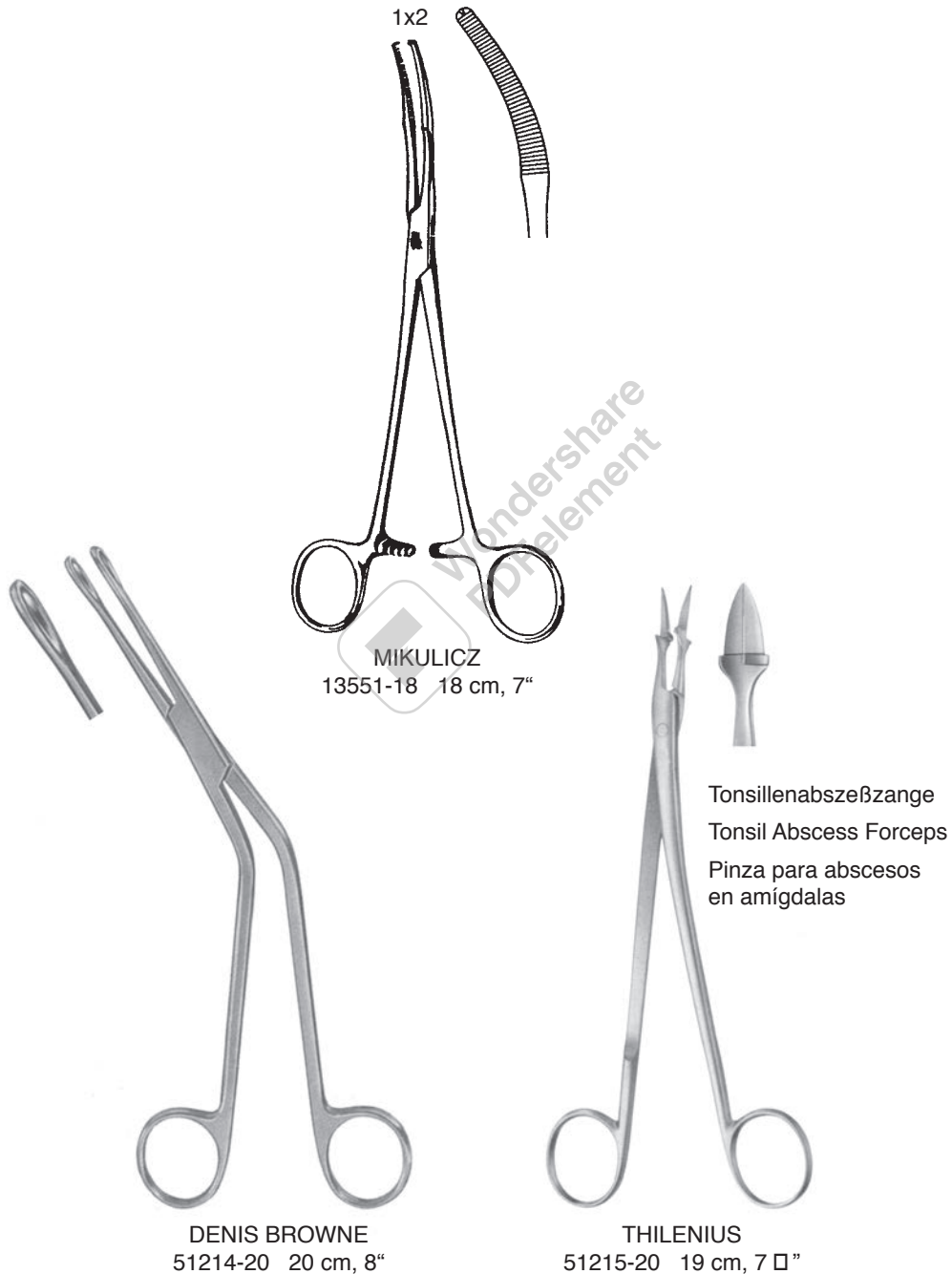

Saugrohr
Suction Tube
Tubo de succion

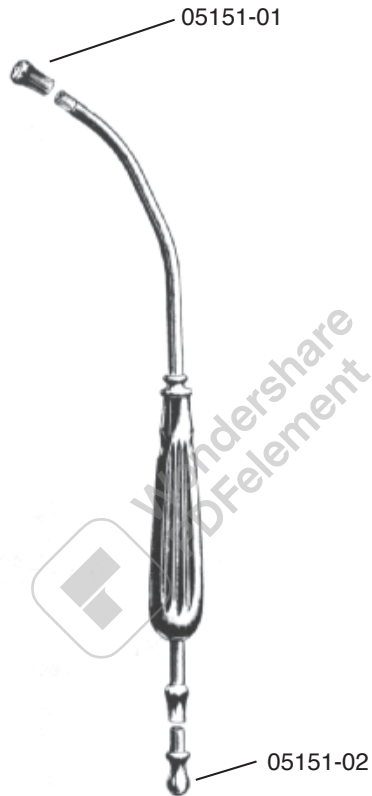

BABY-YANKAUER
05150-21 21 cm, 8 □"

YANKAUER, compl.
05150-27 27 cm, 10 □"

Tonsillennadeln
Tonsil Needles
Agujas para amígdalas

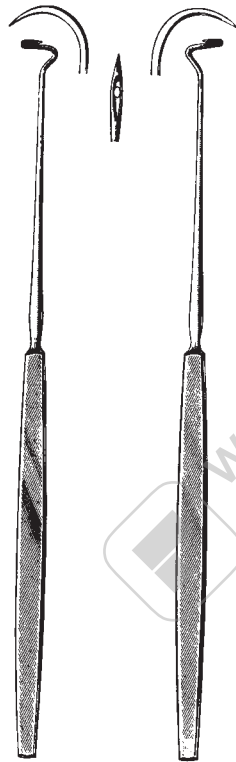

DUPUY-WEISS
51165-22 51167-22
22 cm 8 □"



CLAUS
51168-23
23 cm 9"

Tonsillennadeln, Tonsillenmesser
Tonsil Needles, Tonsil Knives
Agujas para amígdalas, Bisturios para amígdalas



NAGER
51170-24
24 cm 9 1/2"



FISHER
51171-22
22,5 9"

Tonsillennmesser
Tonsil Knives
Bisturries para amígdalas



ABRAHAM
51172-19
19 cm, 7 1/2"



ABRAHAM
51173-21
21 cm, 8 1/2"



CANFIELD
51174-21
21 cm, 8 1/2"



BRUENINGS
51177-23
23 cm, 9"

Uvulahaken
Uvula Retractors
Separadores uvulares

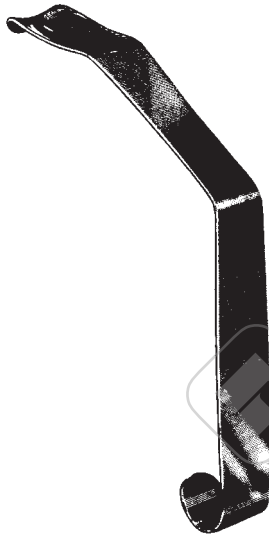

LOVE 15 cm, 6"
51103-18 18 mm
51103-20 20 mm
51103-22 22 mm

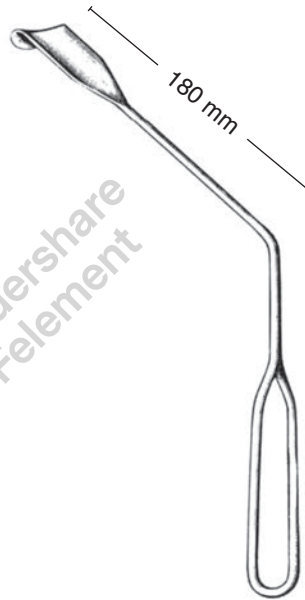

LOTHROP
51104-18 18 mm

Gaumensegelhalter
Soft Palate Retractors
Separadores para la vela palatina

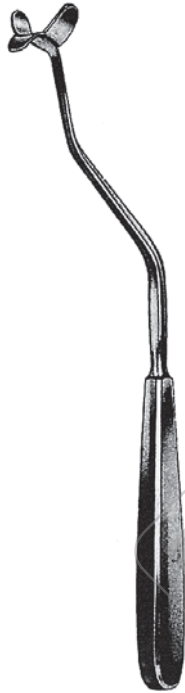

HOFER
51109-24
24 cm, 9 1/2"



NAGER
51111-23
23 cm, 9"

Tonsillenelevatoren, Tonsillendisektoren
Tonsil Elevators, Tonsil Dissectors
Elevadores/disectores para amígdalas

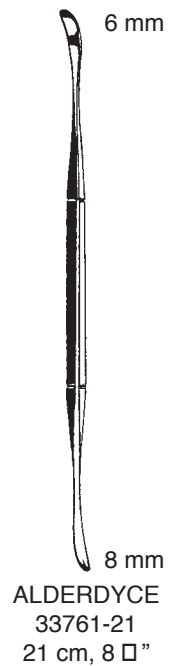
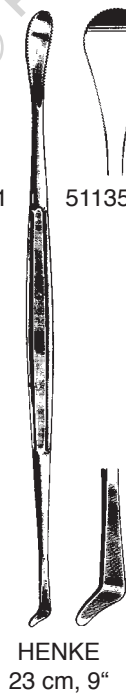
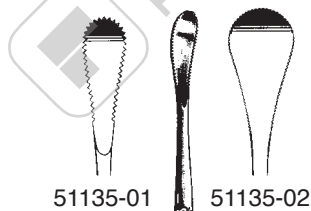
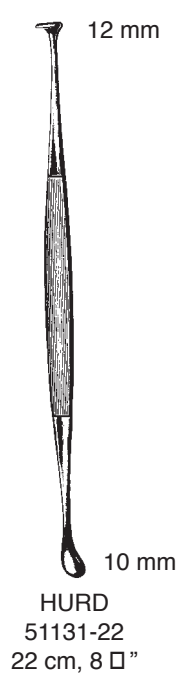

Tonsillendisektoren
Tonsil Dissectors
Disectores para amígdalas

Enukleator
Enucleator
Enucleador



CARPENTER
51139-25
25 cm, 10"



CARPENTER
51143-24
24 cm, 9 1/2"

Tamponstopfer
Gauze Packer
Tamponador tonsilar

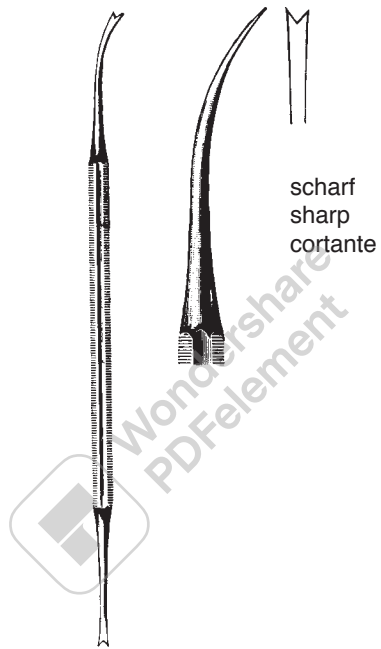

LUNIATSCHEK
51151-19
19 cm, 7 1/2"

Speichelgangsonde
Salivary Duct Probe
Sonda para el canal de saliva

geknöpft
buttoned
abotonada



rostfrei
stainless steel
acero inoxidable

Fig.	BOWMAN	Ø mm
0000/000	43613-00	0,6/0,7
00/0	43614-00	0,7/0,8
0/1	43614-01	0,8/0,9
1/2	43614-12	0,9/1,1
2/3	43614-23	1,1/1,3
3/4	43614-34	1,3/1,4
4/5	43614-45	1,4/1,5
5/6	43614-56	1,5/1,6
6/7	43614-67	1,6/1,8
7/8	43614-78	1,8/1,9

Anatomische und chirurgische Pinzetten
Dressing and Tissue Forceps
Pinzas de disección, sin/con dientes



POTTS-SMITH

11112-18	18 cm, 7"	11116-18 TC
11112-21	21 cm, 8 1/4"	11116-21 TC
11112-25	25 cm, 10"	11116-25 TC



1x2

POTTS-SMITH

11126-18	18 cm, 7"	
11126-21	21 cm, 8 1/4"	
11126-25	25 cm, 10"	

Tupferzangen
Dressing Forceps
Pinzas porta-esponjas



DUPLAY
17131-21 21 cm, 8 1/4"



17133-17 17 cm, 6 3/4"

Tonsillenscheren
Tonsil Scissors
Tijeras para amígdalas

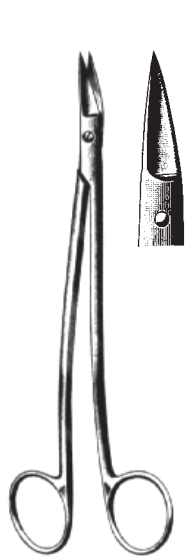

— DEAN —
09425-17 09427-17
17 cm, 6 1/2"

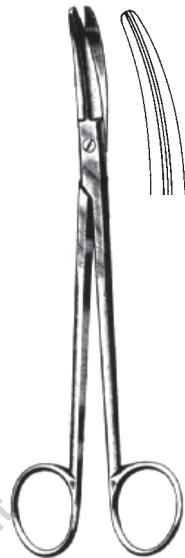

BOETTCHER
09435-18
18 cm, 7"

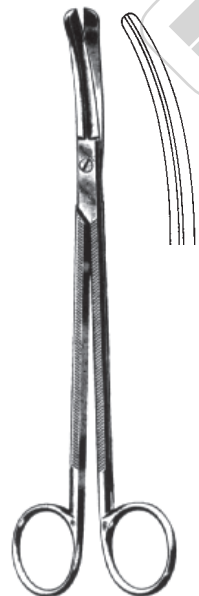

GOOD
09437-19
19 cm, 7 1/2"

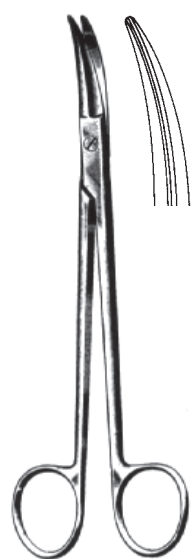

PRINCE
09439-17
17 cm, 6 1/2"

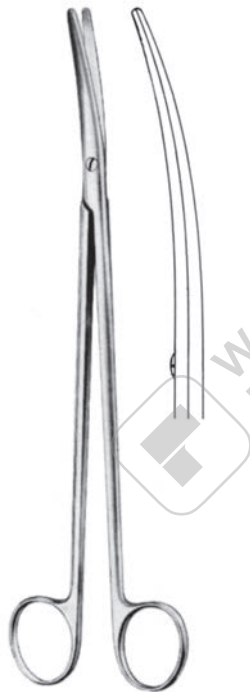
Präparierscheren
Dissecting Scissors
Tijeras de disección

METZENBAUM

09281-12	09285-12 TC
12 cm	4 1/4"
09281-15	09285-15 TC
15 cm	6"
09281-18	09285-18 TC
18 cm	7"
09281-20	09285-20 TC
20 cm	8"
09281-23	09285-23 TC
23 cm	9"
09281-25	09285-25 TC
25 cm	10"
09281-28	09285-28 TC
28 cm	11"
09281-30	09285-30 TC
30 cm	12"

Speichelgangschere
Salival Scissors
Tijeras para el canal de saliva

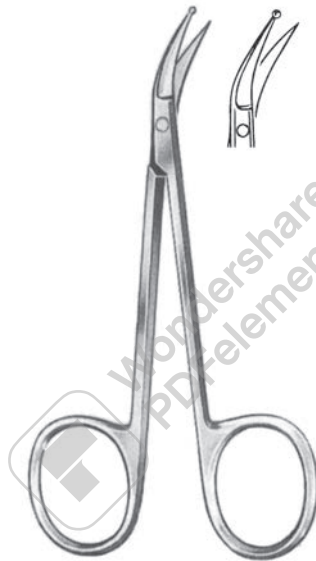

PERWITZSCHKY
09364-10
10 cm, 4"

Draht-, Blehschere
Wire and Plate Scissors
Tijeras para alambre y láminas

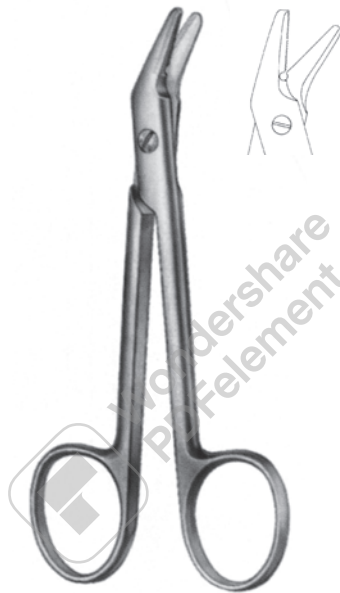

UNIVERSAL

09831-12 12 cm, 4 1/4"

09835-12 TC 12 cm, 4 1/4"

Tonsillenschnürer
Tonsil Snares
Cierranudos para amígdalas

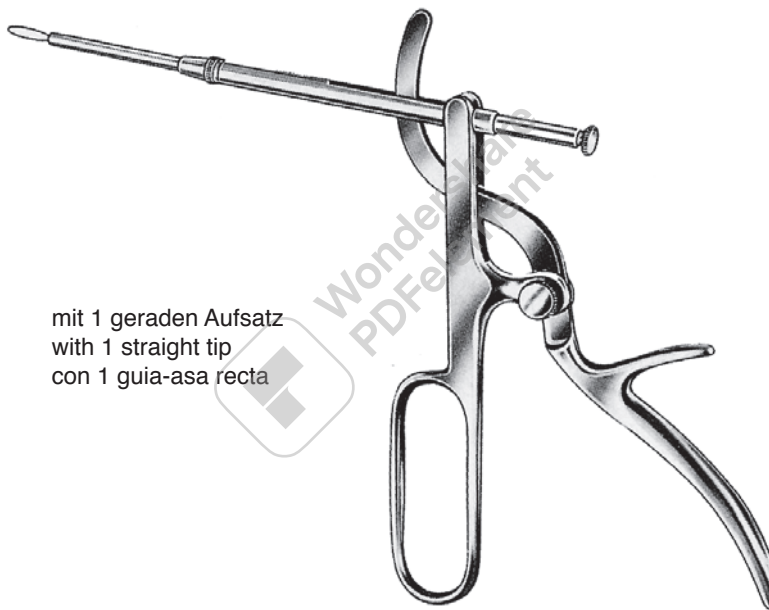

mit 1 geraden Aufsatz
with 1 straight tip
con 1 guía-asa recta

TYDING
51260-00

Tonsillenschnürer
Tonsil Snares
Cierranudos para amígdalas



EVES
51250-28
28 cm, 11"



EVES
51252-28
28 cm, 11"



BRUENINGS
51256-28
28 cm, 11"

Tonsillendraht
Tonsil Wire
Hilos para amígdalas

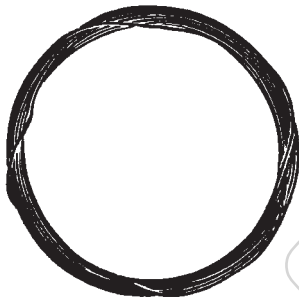

mm Ø
34520-02 0,2
34520-03 0,3
34520-04 0,4

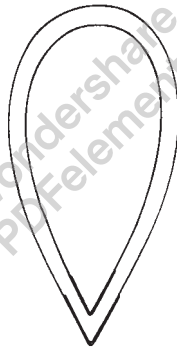

51257-40 40 mm
51257-50 50 mm
Pack of 100 pcs



51259-03 0,3 mm
51259-04 0,4 mm
51259-05 0,5 mm
Pack of 12 pcs

Tonsillenschnürer
Tonsil Snares
Cierranudos para amígdalas

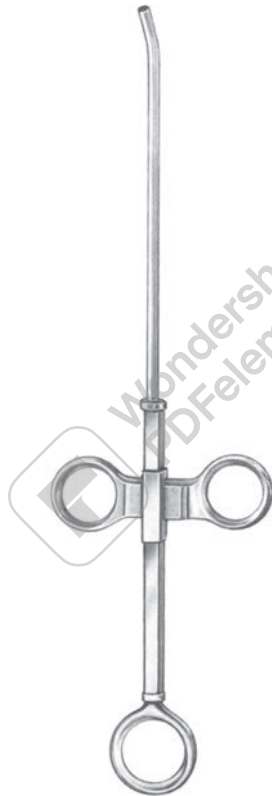

ROEDER "E"
51265-00
27 cm, 10 □"

Fadengabel
Knot Tier
Horquilla de hilos

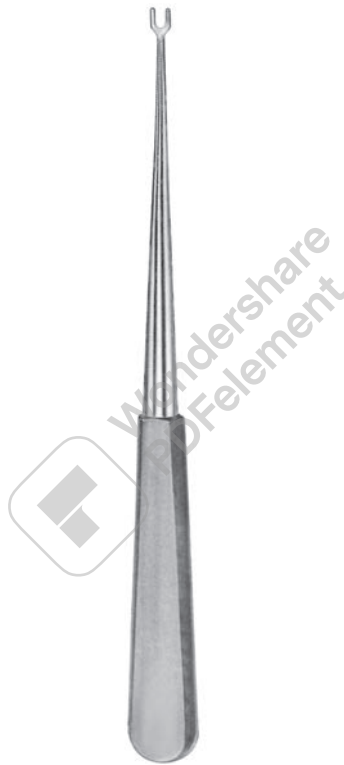

NEGUS
51176-20
20,5 cm, 8"

Tonsillotom
Tonsillectome
Amigdalótomo

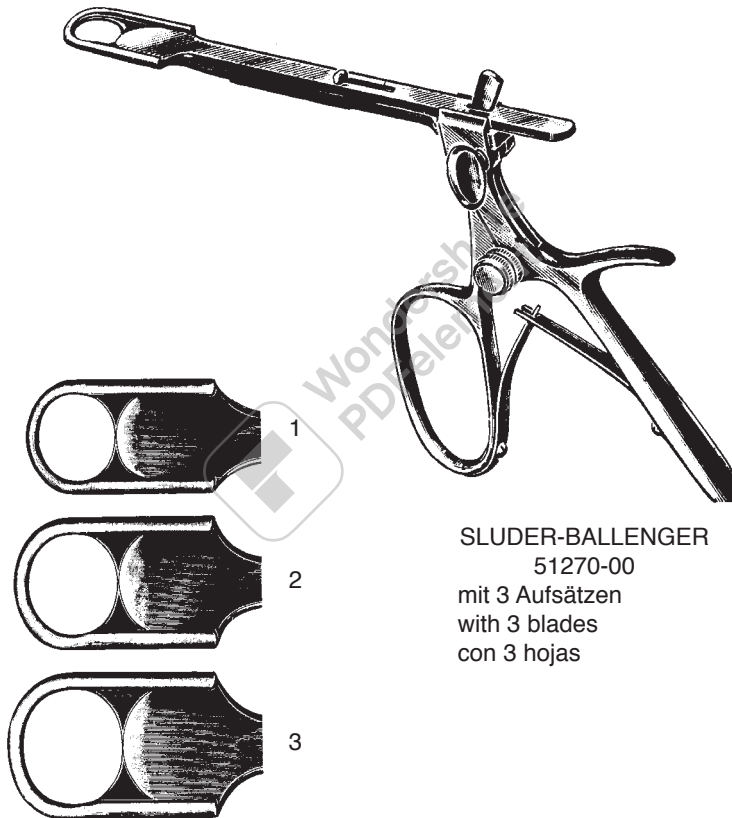

SLUDER-BALLENGER
51270-00
mit 3 Aufsätzen
with 3 blades
con 3 hojas

Septum Nadeln, Spritzen
Septum Needles, Syringes
Agujas para septum, Jeringas



51291-00
2,5 mm Ø

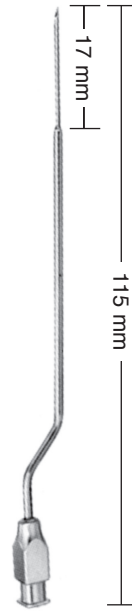

51293-00
0,8 mm Ø



51293-90
90°



51293-45
45°



51292-00

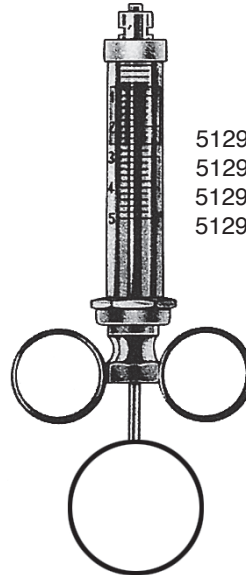

51290-02 2 ml
51290-05 5 ml
51290-10 10 ml
51290-20 20 ml

Tonsillenzangen
Tonsil Punches
Pinzas para amígdalas

scharf
sharp
cortante

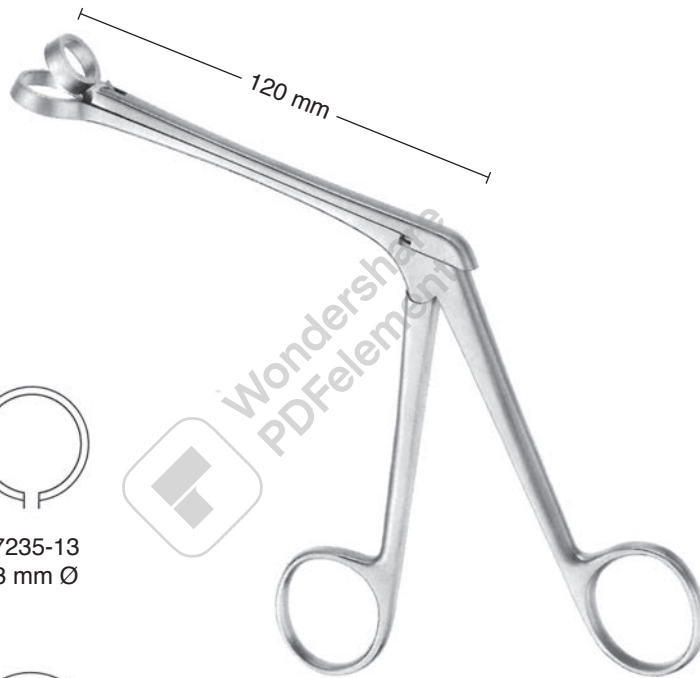

47235-13
13 mm Ø



47235-15
15 mm Ø

HARTMANN

Ringmesser
Adenoid Curettes
Cuchillos para vegetaciones adenoideas



BECKMANN
22 cm, 8 □"

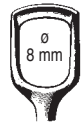

47620-00
Fig. 0

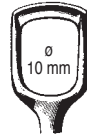

47620-01
Fig. 1

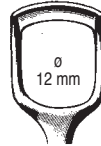

47620-02
Fig. 2

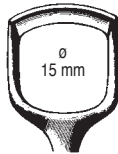

47620-03
Fig. 3

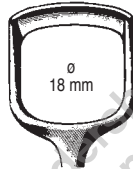

47620-04
Fig. 4

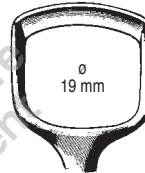

47620-05
Fig. 5

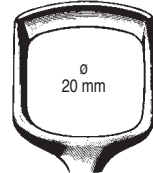

47620-06
Fig. 6



BARNHILL
21 cm, 8 □"



47630-00
Fig. 0



47630-01
Fig. 1

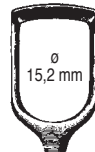

47630-02
Fig. 2

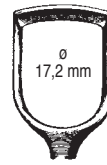

47630-03
Fig. 3

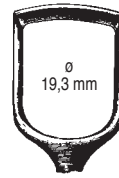

47630-04
Fig. 4

Ringmesser, Adenotome
Adenoid Currettes, Adenotomes
Cuchillos para vegetaciones adenoideas, Adenotomos



St. CLAIR-THOMSON
21 cm, 8 1/4"

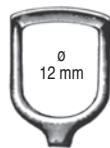

47636-01
Fig. 1



47636-02
Fig. 2

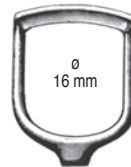

47636-03
Fig. 3

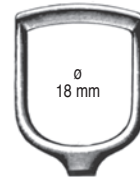

47636-04
Fig. 4



LAFORCE
25 cm, 10"



47641-01
Fig. 1
ø 12 mm



47641-02
Fig. 2
ø 16 mm



47641-03
Fig. 3
ø 18 mm

Ersatzklingen allein, gelocht
Spare blades, perforated
Hojas de repuesto, perforadas

Fig. 1 47642-01
Fig. 2 47642-02
Fig. 3 47642-03

Nasenrachenzangen
Naso Pharyngeal Forceps
Pinzas naso-faringeas

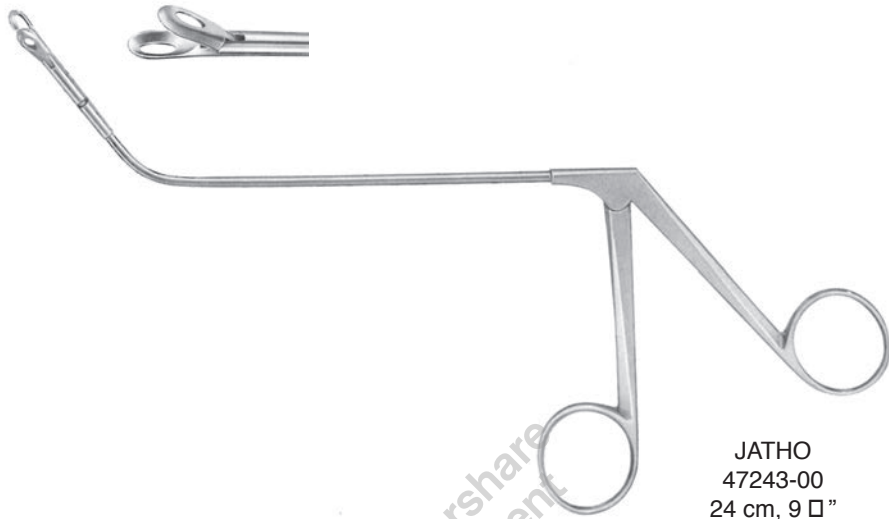

ST. CLAIR-THOMSON
47246-18 18 cm, 7 1/8"

Nasenrachenzangen
Naso Pharyngeal Forceps
Pinzas naso-faringeas



JURASZ
21 cm, 8 1/2"



JURASZ
47244-00 19 cm, 7 1/2"





TRACHEOTOMIE

TRACHEOTOMY

TRAQUEOTOMÍA

HADEO
INSTRUMENTE GERMANY

Indikationen und Kontraindikationen finden Sie in der entsprechenden Gebrauchsanweisung!
Indication and Contraindication please refer to our user's manual!
Indicaciones y Contraindicaciones se encuentran en la instrucciones de uso correspondientes!

Tracheal Dilatoren, Trachealhaken, Trachealwundspreizer
 Tracheal Dilators, Tracheal Hooks, Tracheal Retractors
 Diladores traqueales, Ganchos traqueales, Retractor traqueal

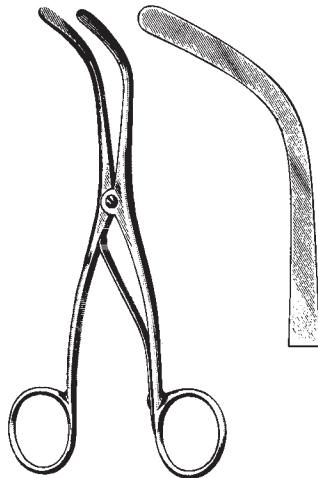

TROUSSEAU-BABY
55111-13 13 cm, 5 1/8"

TROUSSEAU
55111-14 14 cm, 5 1/4"

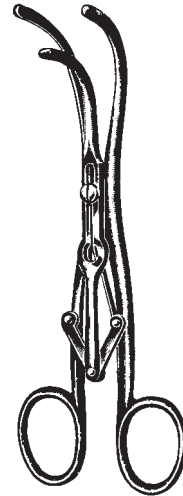

LABORDE
55113-14
14 cm, 5 1/4"



BOSE
55115-07
7 cm, 2 3/4"

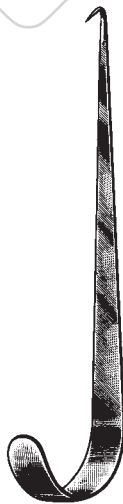

JACKSON
55116-15
15 cm, 6"



JACKSON
55117-17
17 cm, 6 3/4"

Trachealhaken, Kanülen
Tracheal Hooks, Tubes
Ganchos traqueales Cánulas



ITERSON
16 cm, 6 1/4"



NEWS
55120-15
15 cm, 6"



BOSE
55122-16
16 cm, 6 1/4"

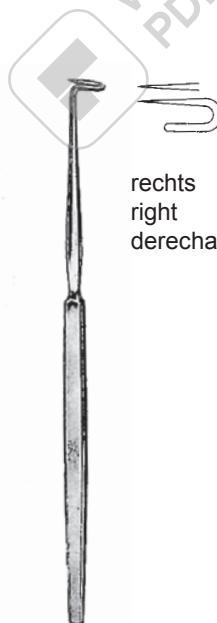

BOSE
55124-16
16 cm, 6 1/4"



WAGENER-MOSHER
55151-05 5 mm
55151-07 7 mm
55151-09 9 mm

Trachealkanülen
 Tracheal Tubes
 Canulas traqueales

Fig.	Ø mm	Länge des Außenrohrs Length of outer tube Largo de la cánula exterior	LUER Neusilber German silver alpaca	CHEVALIER-JACKSON Neusilber German silver alpaca
0	4	45 mm	55220-04	55240-04
1	5	50 mm	55220-05	55240-05
2	6	55 mm	55220-06	55240-06
3	7	60 mm	55220-07	55240-07
4	8	65 mm	55220-08	55240-08
5	9	70 mm	55220-09	55240-09
6	10	75 mm	55220-10	55240-10
7	11	80 mm	55220-11	55240-11
8	12	85 mm	55220-12	55240-12
9	13	90 mm	55220-13	55240-13

Kropfsonde, Schilddrüsenhaken
Thyroid Dissectors, Thyroid Retractor
Sondas para bocio, Separador para la glándula tiroidea

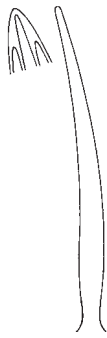

55501-15



55503-15

KOCHER
15 cm, 6"



SCHOENBORN
55511-21
21 cm, 8 1/4"

Kropffäßzange, Muskelklemme
Goitre Seizing Forceps, Muscular Clamp
Pinza para coger el bocio, Pinza para músculos

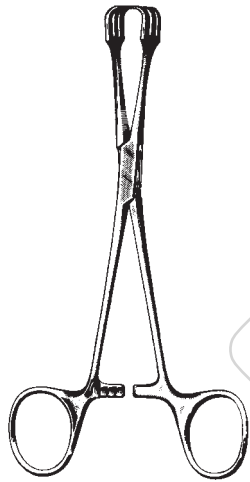

LAHEY
55520-15 15 cm, 6"
55520-20 20 cm, 8"

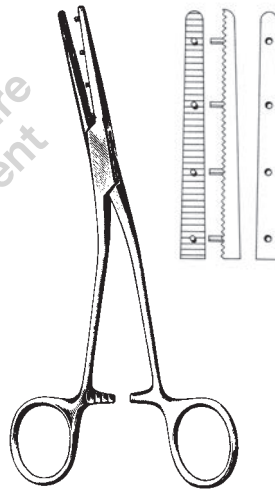

MASTIN
55523-17
17 cm, 6 1/2"

Kehlkopf Polypenschnürer
Laryngeal Polypus Snare
Cierranudo para pólipos



51259-04
Ø 0,4 mm
Pack of 12 pcs

Schnürerdraht
Snare Wire
Alambre para polipotomo



53122-00
Nutzlänge 24 cm, 9 1/2"
Working length 24 cm, 9 1/2"
Largo útil 24 cm, 9 1/2"





LARYNGOSKOPIE
ENDOLARYNGEALE
MIKROCHIRURGIE

LARYNGOLOGY
ENDOLARYNGEAL
MICROSURGERY

LARINGOSCOPIA
MICRO CIRUGIA
ENDOLARINGEAL

HADEO
INSTRUMENTE GERMANY



Indikationen und Kontraindikationen finden Sie in der entsprechenden Gebrauchsanweisung!
Indication and Contraindication please refer to our user's manual!
Indicaciones y Contraindicaciones se encuentran en la instrucciones de uso correspondientes!

Kaltlicht Laryngoskope
Fiber Optic Laryngoscopes
Laringoscopios de luz fría



Kaltlicht
Cold Light
Luz fría



McINTOSH

05212-03

Set bestehend aus:

- 1 Etui
- 1 Batteriegriff 05238-03
- 3 Spatel (Fig. 2-4)
- 1 Ersatzlampe Xenon 05239-03

Set consisting of:

- 1 Case
- 1 Handle 05238-03
- 3 Blades (Fig. 2-4)
- 1 Spare Bulb Xenon 05239-03

Juego compuesto de:

- 1 Estuche
- 1 Mango 05238-03
- 3 Hojas (Fig. 2-4)
- 1 Bombilla de recambio Xenon 05239-03

05212-04

Set bestehend aus:

- 1 Etui
- 1 Batteriegriff 05238-03
- 4 Spatel (Fig. 1-4)
- 1 Ersatzlampe Xenon 05239-03

Set consisting of:

- 1 Case
- 1 Handle 05238-03
- 4 Blades (Fig. 1-4)
- 1 Spare Bulb Xenon 05239-03

Juego compuesto de:

- 1 Estuche
- 1 Mango 05238-03
- 4 Hojas (Fig. 1-4)
- 1 Bombilla de recambio Xenon 05239-03

Laryngoskopie-Spatel mit integriertem Kaltlichtträger
Laryngoscope Blades with Integrated Cold Light Carrier
Espátulas de laringoscopios con luz fría integrada

Kaltlicht
Cold Light
Luz fría



McINTOSH



05211-00
59 mm, 2.32"
Nutzlänge
working length
largo útil

Fig. 0
für Säuglinge
for babies
para neonatales



05211-01
72 mm, 2.83"
Nutzlänge
working length
largo útil

Fig. 1
für Kinder
for children
para niños



05211-02
92 mm, 3.62"
Nutzlänge
working length
largo útil

Fig. 2
für Jugendliche
for adolescents
para adolescentes



05211-03
112 mm, 4.41"
Nutzlänge
working length
largo útil

Fig. 3
für Frauen
for women
para mujeres



05211-04
136 mm, 5.35"
Nutzlänge
working length
largo útil

Fig. 4
für Männer
for men
para hombres

Laryngoskopie Spatel mit integriertem Kaltlichtträger
Laryngoscope Blades with Integrated Cold Light Carrier
Espátulas de laringoscopios con luz fría integrada



Kaltlicht
Cold Light
Luz fría

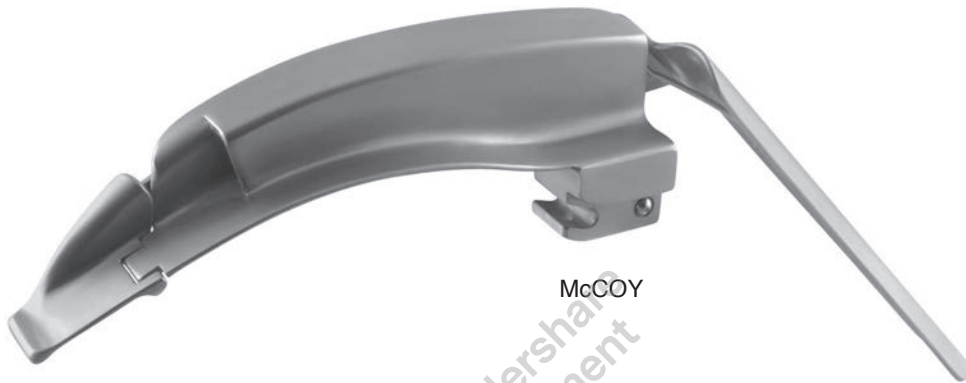

McCOY

Nutzlänge
working length
largo útil

Fig. 2	05217-02	92 mm
Fig. 3	05217-03	112 mm
Fig. 4	05217-04	136 mm

Kaltlicht
Cold Light
Luz fría



Kaltlicht Laryngoskope
Fiber Optic Laryngoscopes
Laringoscopios de luz fría



MILLER

05213-03CL

Set bestehend aus:

- 1 Etui
- 1 Batteriegriff 05238-03
- 3 Spatel (Fig. 1-3)
- 1 Ersatzlampe Xenon 05239-03

Set consisting of:

- 1 Case
- 1 Handle 05238-03
- 3 Blades (Fig. 1-3)
- 1 Spare Bulb Xenon 05239-03

Juego compuesto de:

- 1 Estuche
- 1 Mango 05238-03
- 3 Hojas (Fig. 1-3)
- 1 Bombilla de recambio Xenon 05239-03

05213-04CL

Set bestehend aus:

- 1 Etui
- 1 Batteriegriff 05238-03
- 4 Spatel (Fig. 1-4)
- 1 Ersatzlampe Xenon 05239-03

Set consisting of:

- 1 Case
- 1 Handle 05238-03
- 4 Blades (Fig. 1-4)
- 1 Spare Bulb Xenon 05239-03

Juego compuesto de:

- 1 Estuche
- 1 Mango 05238-03
- 4 Hojas (Fig. 1-4)
- 1 Bombilla de recambio Xenon 05239-03

Laryngoskopie-Spatel mit integriertem Kaltlichtträger
Laryngoscope Blades with Integrated Cold Light Carrier
Espátulas de laringoscopios con luz fría integrada



Kaltlicht
Cold Light
Luz fría

MILLER



05230-00CL
55 mm, 2.16"
Nutzlänge
working length
largo útil

Fig. 0
für Säuglinge
for babies
para neonatales



05230-01CL
80 mm, 3.15"
Nutzlänge
working length
largo útil

Fig. 1
für Kinder
for children
para niños

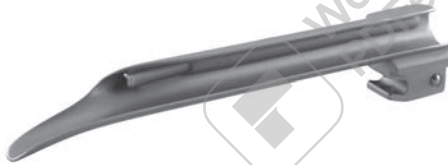

05230-02CL
130 mm, 5.12"
Nutzlänge
working length
largo útil

Fig. 2
für Jugendliche
for adolescents
para adolescentes



05230-03CL
170 mm, 6.69"
Nutzlänge
working length
largo útil

Fig. 3
für Frauen
for women
para mujeres



05230-04CL
188 mm, 7.4"
Nutzlänge
working length
largo útil

Fig. 4
für Männer
for men
para hombres

Laryngoskope Warmlicht
Laryngoscopes Warm Light
Laringoscopios de luz calienteWarmlicht
Warm Light
Luz caliente

McINTOSH

05203-00

Set bestehend aus:

- 1 Etui
- 1 Batteriegriff 05234-28
- 3 Spatel (Fig. 2-4)
- 2 Ersatzlampen 05239-02

Set consisting of:

- 1 Case
- 1 Handle 05234-28
- 3 Blades (Fig. 2-4)
- 2 Spare Bulbs 05239-02

Juego compuesto de:

- 1 Estuche
- 1 Mango 05234-28
- 3 Hojas (Fig. 2-4)
- 2 Bombilla de recambio 05239-02

05204-00

Set bestehend aus:

- 1 Etui
- 1 Batteriegriff 05234-28
- 4 Spatel (Fig. 1-4)
- 2 Ersatzlampen 05239-02

Set consisting of:

- 1 Case
- 1 Handle 05234-28
- 4 Blades (Fig. 1-4)
- 2 Spare Bulbs 05239-02

Juego compuesto de:

- 1 Estuche
- 1 Mango 05234-28
- 4 Hojas (Fig. 1-4)
- 1 Bombilla de recambio 05239-02

Laryngoskopie-Spatel mit integriertem Warmlichtträger
Laryngoscope Blades with Integrated Warm Light Carrier
Espátulas de laringoscopios con luz caliente integrada



Warmlicht
Warm Light
Luz caliente

McINTOSH



05210-00
59 mm, 2.32"
Nutzlänge
working length
largo útil

Fig. 0
für Säuglinge
for babies
para neonatales



05210-01
72 mm, 2.83"
Nutzlänge
working length
largo útil

Fig. 1
für Kinder
for children
para niños



05210-02
92 mm, 3.62"
Nutzlänge
working length
largo útil

Fig. 2
für Jugendliche
for adolescents
para adolescentes



05210-03
112 mm, 4.41"
Nutzlänge
working length
largo útil

Fig. 3
für Frauen
for women
para mujeres



05210-04
136 mm, 5.35"
Nutzlänge
working length
largo útil

Fig. 4
für Männer
for men
para hombres

Laryngoskope Warmlicht
Laryngoscopes Warm Light
Laringoscopios de luz calienteWarmlicht
Warm Light
Luz caliente

MILLER

05213-03

Set bestehend aus:

- 1 Etui
- 1 Batteriegriff 05234-28
- 3 Spatel (Fig. 1-3)
- 1 Ersatzlampe 05239-01
- 1 Ersatzlampe 05239-02

Set consisting of:

- 1 Case
- 1 Handle 05234-28
- 3 Blades (Fig. 1-3)
- 1 Spare Bulb 05239-01
- 1 Spare Bulb 05239-02

Juego compuesto de:

- 1 Estuche
- 1 Mango 05234-28
- 3 Hojas (Fig. 1-3)
- 1 Bombilla de recambio 05239-01
- 1 Bombilla de recambio 05239-02

05213-04

Set bestehend aus:

- 1 Etui
- 1 Batteriegriff 05234-28
- 4 Spatel (Fig. 1-4)
- 1 Ersatzlampe 05239-01
- 1 Ersatzlampe 05239-02

Set consisting of:

- 1 Case
- 1 Handle 05234-28
- 4 Blades (Fig. 1-4)
- 1 Spare Bulb 05239-01
- 1 Spare Bulb 05239-02

Juego compuesto de:

- 1 Estuche
- 1 Mango 05234-28
- 4 Hojas (Fig. 1-4)
- 1 Bombilla de recambio 05239-01
- 1 Bombilla de recambio 05239-02

Laryngoskope Warmlicht
Laryngoscopes Warm Light
Laringoscopios de luz caliente



Warmlicht
Warm Light
Luz caliente

MILLER



05230-00
55 mm, 2.16"
Nutzlänge
working length
largo útil

Fig. 0
für Säuglinge
for babies
para neonatales



05230-01
80 mm, 3.15"
Nutzlänge
working length
largo útil

Fig. 1
für Kinder
for children
para niños



05230-02
130 mm, 5.12"
Nutzlänge
working length
largo útil

Fig. 2
für Jugendliche
for adolescents
para adolescentes



05230-03
170 mm, 6.69"
Nutzlänge
working length
largo útil

Fig. 3
für Frauen
for women
para mujeres



05230-04
188 mm, 7.4"
Nutzlänge
working length
largo útil

Fig. 4
für Männer
for men
para hombres

Warmlicht
Warm Light
Luz caliente



Laryngoskope Warmlicht
Laryngoscopes Warm Light
Laringoscopios de luz caliente

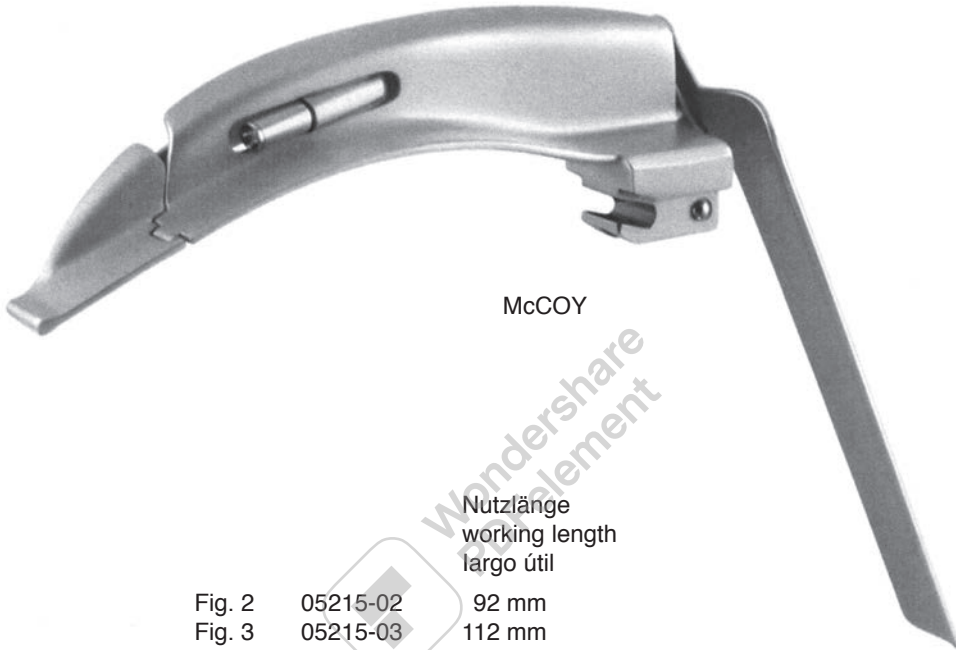

McCOY

Nutzlänge
working length
largo útil

Fig. 2	05215-02	92 mm
Fig. 3	05215-03	112 mm
Fig. 4	05215-04	136 mm

Batteriegriffe, Edelstahl
Battery Handles, Stainless Steel
Mango de pila, acero inoxidable



Kaltlicht
Cold Light
Luz fría



15,5 cm
19 mm Ø

05238-02



15,5 cm
28 mm Ø

05238-03



05239-03 Xenon 2,5 V

Ersatzlampe
Spare Bulb
Bombilla de recambio

05238-12

05238-13

mit Xenon-Lampe
with Xenon-Lamp
con lampara Xenon

mit LED-Lampe
with LED-Lamp
con lampara LED

Warmlicht
Warm Light
Luz caliente



Batteriegriffe, Edelstahl
Battery Handles, Stainless Steel
Mango de pila, acero inoxidable



05233-18
14 cm
19 mm Ø



05234-28
14,5 cm
29 mm Ø



05239-01 2,5 V
Fig. 0-1



05239-02 2,5 V
Fig. 2-4

Ersatzlampe
Spare Bulb
Bombilla de recambio

Operations-Laryngoskope
Operation Laryngoscope
Laringoscopios operativo

rostfreier Edelstahl
Rohr: innen matt/außen glänzend
Griff: matt

stainless steel
tube: inner surface mat/outer
surface polished
handle: mat

acero inoxidable
Pala: Superficie interior: mate
Superficie exterior: brillante
Mango: mate

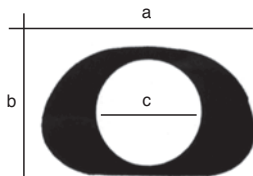

Nr.	L (mm)	a (mm)	b (mm)	c (mm)	Lichtträger light guide Portador de luz
05301-01	130	19,5	12,0	10,5	05302-01
05301-02	150	20,5	13,0	10,5	05302-01
05301-03	170	26,0	15,5	13,5	05302-02
05301-04	170	28,5	18,5	15,0	05302-02
05301-05	170	31,5	21,5	19,0	05302-02

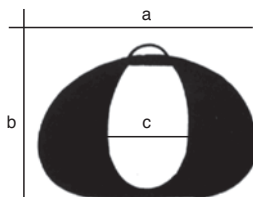

Nr.	L (mm)	a (mm)	b (mm)	c (mm)	Lichtträger light guide Portador de luz
05301-06	180	25,0	16,0	12,0 x 18,0	05302-02
05301-07	220	25,0	16,0	12,0 x 18,0	05302-03

Operations-Laryngoskope
Operation Laryngoscope
Laringoscopios operativo

05300-01

Bruststütze für Erwachsene, Set bestehend aus: 05300-03 / 05300-05 / 05300-06

Chest Support for adults, complete consisting of: 05300-03 / 05300-05 / 05300-06

Soporte pectoral para adultos, compuesto de: 05300-03 / 05300-05 / 05300-06

05300-02

Bruststütze für Kinder, Set bestehend aus: 05300-04 / 05300-05 / 05300-06

Chest Support for children, complete consisting of: 05300-04 / 05300-05 / 05300-06

Soporte pectoral para niños, compuesto de: 05300-04 / 05300-05 / 05300-06



LEWY Bruststütze, für Operations-Laryngoskop
LEWY Chest Support, for Operation Laryngoscope
Soporte pectoral LEWY para laringoscopios operativo

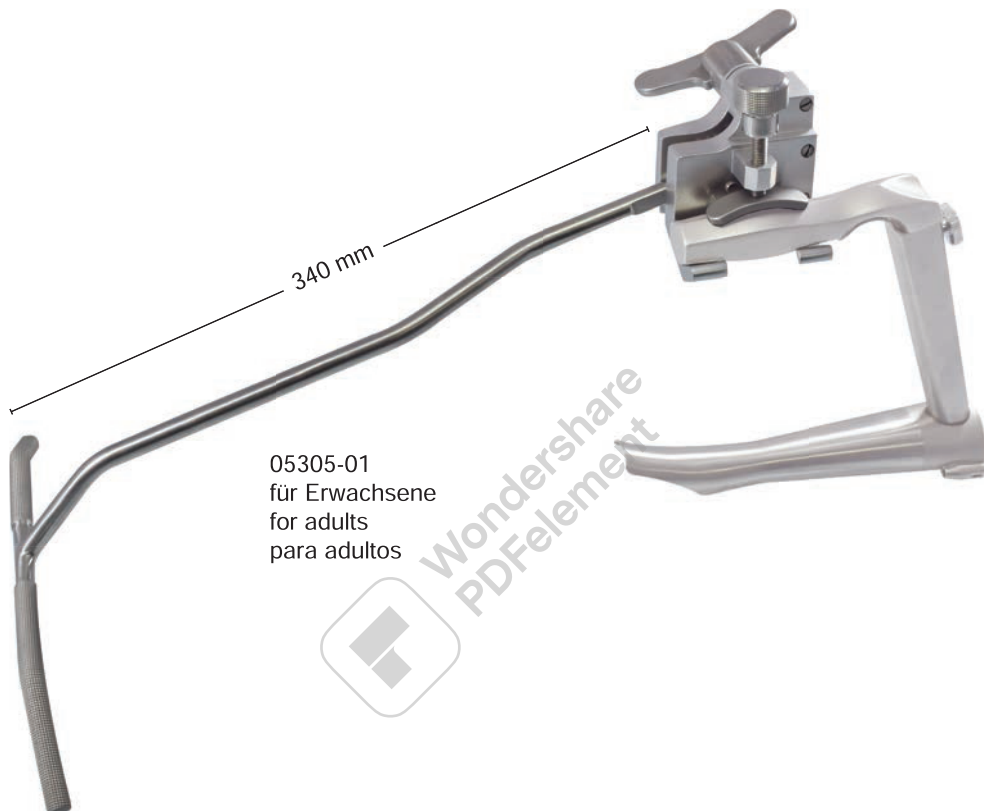

05305-01
für Erwachsene
for adults
para adultos

05305-02
Laryngoskope-Handgriff, abnehmbar
Laryngoscope Handle, detachable
Mango para laringoscopios, desmontable

Verwendung mit
use with
utilizar con

05305-01
LEWY Bruststütze für Operations-Laryngoskope
LEWY Chest Support for Operating Laryngoscope
Soporte pectoral LEWY para laringoscopios operativo



Fiberglas Lichtträger
Fiberglass Light Carriers
Portador de luz fría

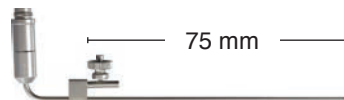

75 mm

05302-01 for Laryngoskope
05301-01 - 05301-02

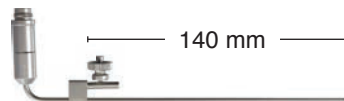

140 mm

05302-02 for Laryngoskope
05301-03 - 05301-06

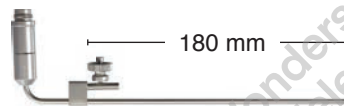

180 mm

05302-03 for Laryngoskope
05301-07

05303-01

Injektionskanüle für Laryngoskope: 05301-01 - 05301-07

Injection drain tube for Laryngoscopes: 05301-01 - 05301-07

Canúla de inyección para laringoscopios: 05301-01 - 05301-07



ACMI

WOLF

STORZ

Unsere Fiberglas-Lichtträger werden mit allen Adaptern geliefert.
Our Fiberglass light carriers are supplied with all adapters.
Todos nuestros portadores de luz de fibra optica se suministran
con todos los adaptadores.

Fiberglas Lichtträger
Fiberglass Light Carriers
Portador de luz fría



05303-10
Leuchtklammer
Light Clip
Grapa para iluminación

05304-01
Rauchabsaugrohr für Laryngoskope: 05301-03 - 05301-07
Suction tube for Laryngoscopes: 05301-03 - 05301-07
Canúla de succion para laringoscopios: 05301-03 - 05301-07

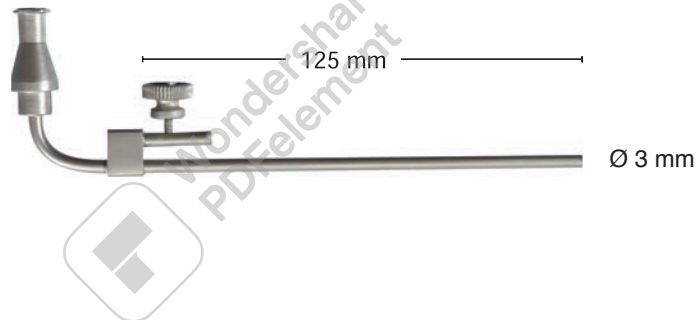

05304-02
Rauchabsaugrohr für Laryngoskope: 05301-01 - 05301-02
Suction tube for Laryngoscopes: 05301-01 - 05301-02
Canúla de succion para laringoscopios: 05301-01 - 05301-02

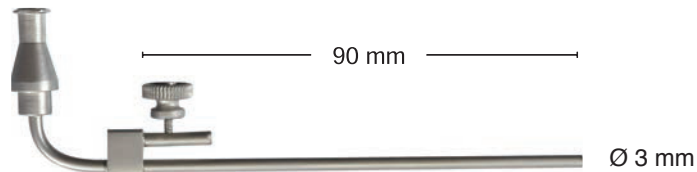

ACMI

WOLF

STORZ

Unsere Fiberglas-Lichtträger werden mit allen Adaptern geliefert.
Our Fiberglass light carriers are supplied with all adapters.
Todos nuestros portadores de luz de fibra optica se suministran con todos los adaptadores.

Laryngoskope mit Fiberglass-Lichtträger
Laryngoscopes with Fiberglass Light Carrier
Laringoscopios con portador de luz de fibra óptica

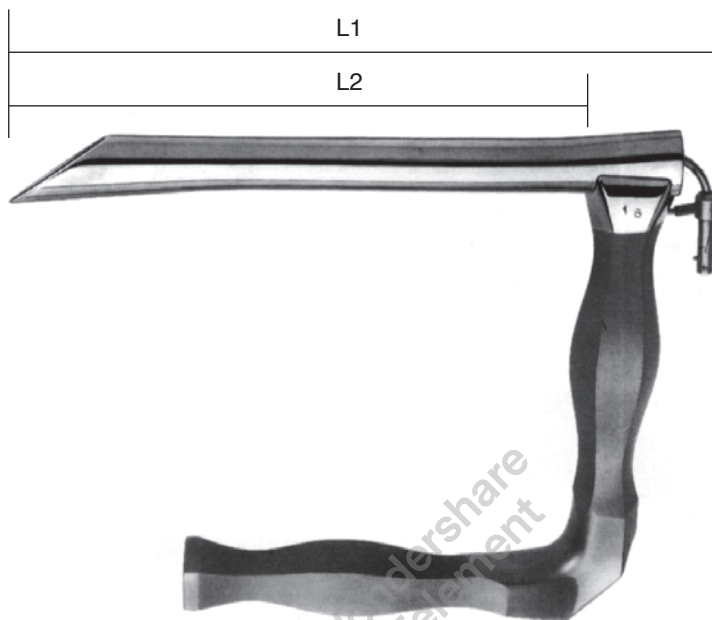

HOLINGER

Nr.	L1	L2	Lichtträger light guide Portador de luz
05310-01	180 mm	158 mm	05311-01
05310-02	170 mm	148 mm	05311-02
05310-03	120 mm	98 mm	05311-03
05310-04	90 mm	68 mm	05311-04



ACMI



WOLF



STORZ

Unsere Fiberglas-Lichtträger werden mit allen Adaptern geliefert.
Our Fiberglass light carriers are supplied with all adapters.
Todos nuestros portadores de luz de fibra optica se suministran
con todos los adaptadores.

Operations-Laryngoskope
 Operation Laryngoscopes
 Laringoscopios operativos



JACKSON

Nr.	L1	L2	Außen-Dm Outer-dm dm-exterior	Innen-Dm Inner-dm dm-interior	Lichtträger light guide Portador de luz
05320-01	180 mm	158 mm	17,0 mm	14,5 mm	05321-01
05320-02	170 mm	148 mm	14,5 mm	12,5 mm	05321-02
05320-03	120 mm	98 mm	14,0 mm	12,0 mm	05321-03
05320-04	90 mm	68 mm	13,0 mm	10,5 mm	05321-04



ACMI



WOLF



STORZ

Unsere Fiberglas-Lichtträger werden mit allen Adaptern geliefert.
 Our Fiberglass light carriers are supplied with all adapters.
 Todos nuestros portadores de luz de fibra optica se suministran
 con todos los adaptadores.

Operations-Laryngoskope
Operation Laryngoscopes
Laringoscopios operativos

spreizbar
spreadable
desplegable

Nr.	L (mm)	a (mm)	b (mm)	c (mm)	Lichtträger light guide Portador de luz
05322-01	130	19,5	12,0	10,5	05302-01
05322-02	150	20,5	13,0	10,5	05302-01
05322-03	170	26,0	15,5	13,5	05302-02
05322-04	170	28,5	18,5	15,0	05302-02
05322-05	170	31,5	21,5	19,0	05302-02
05322-06	180	25,0	16,0	12,0 x 18,0	05302-02
05322-07	220	25,0	16,0	12,0 x 18,0	05302-03



05303-10
Leuchtklammer
Light Clip
Grapa para iluminación

Kehlkopf Polypenzangen
Laryngeal Polypus Forceps
Pinzas para pólipos laringeales

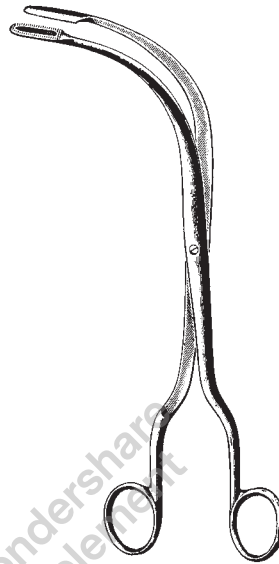

FRAENKEL
53111-18
18 cm, 7"

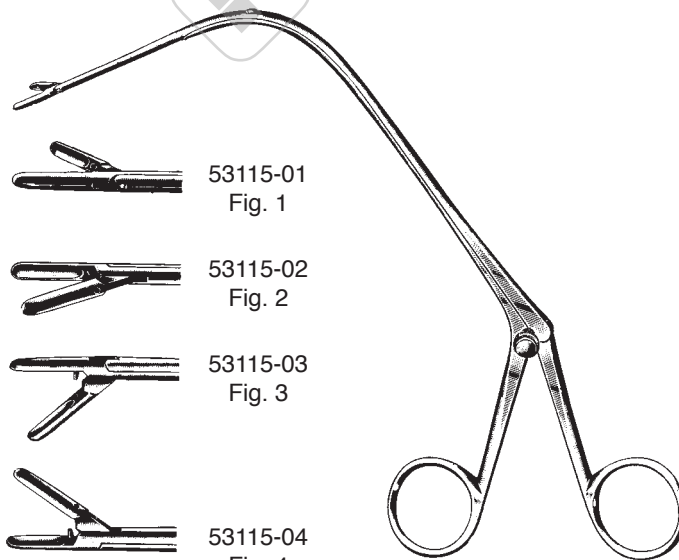

53115-01
Fig. 1

53115-02
Fig. 2

53115-03
Fig. 3

53115-04
Fig. 4

JURASZ
23 cm, 9"

Kehlkopfschere, Kehlkopfpinzette, Kehldeckelhalter
Laryngeal Scissors, Laryngeal Forceps, Epiglottis Retractor
Tijera laringeal, Pinza laringeal, Depresor para epiglottis



KILLIAN
53102-20
20 cm, 8"



53101-22

53103-22

JACKSON
22 cm, 8 1/2"



REICHERT
53121-24
24 cm, 9 1/2"

Kehlkopfkanülen, Tonsillenspritzen
Laryngeal Cannulas, Tonsil Syringes
Cánulas laringeales, Jeringas



51291-00
2,5 mm Ø

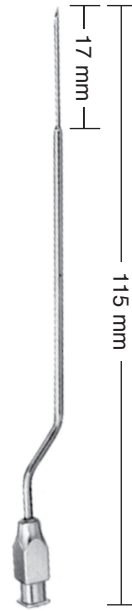

51293-00
0,8 mm Ø



51293-90
90°



51293-45
45°



51292-00

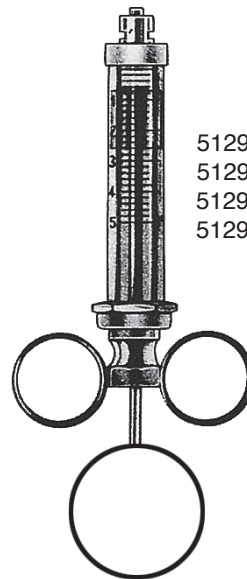

51290-02 2 ml
51290-05 5 ml
51290-10 10 ml
51290-20 20 ml

Kehlkopfspiegel
Laryngeal Mirrors
Espejos laringeales

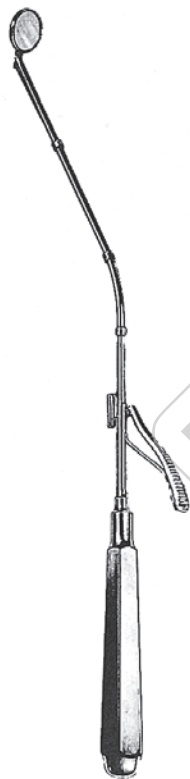

MICHEL
25 cm, 10"



47139-12
12 mm



47139-14
14 mm



47139-16
16 mm



47139-18
18 mm

Kehlkopfspiegel und -griffe
Laryngeal Mirrors and Handles
Espejos y mangos laringeales

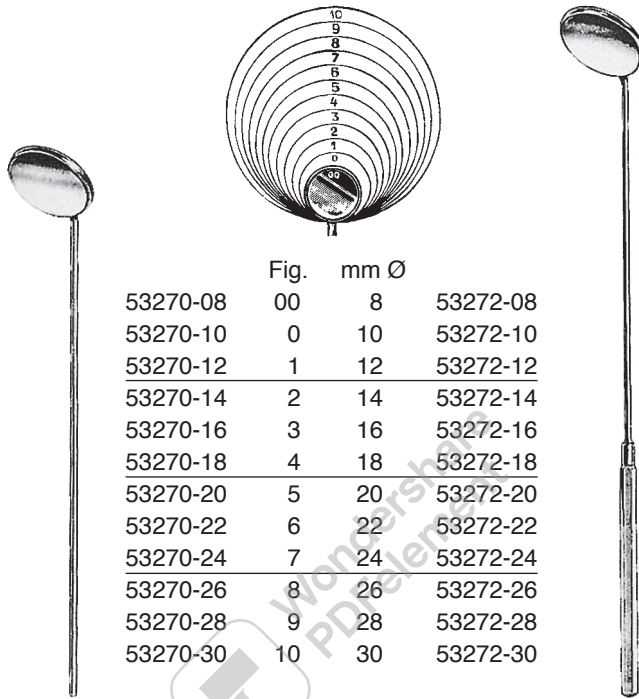

	Fig.	mm Ø	
53270-08	00	8	53272-08
53270-10	0	10	53272-10
53270-12	1	12	53272-12
53270-14	2	14	53272-14
53270-16	3	16	53272-16
53270-18	4	18	53272-18
53270-20	5	20	53272-20
53270-22	6	22	53272-22
53270-24	7	24	53272-24
53270-26	8	26	53272-26
53270-28	9	28	53272-28
53270-30	10	30	53272-30

53270-08 - 53270-30

53272-08 - 53272-30



53274-12



53276-10

Kehlkopf watteträger
Laryngeal Cotton Carriers
Porta-algodones laringeales



Saugrohre
Suction Tubes
Tubos de aspiración

Koagulations-Saugrohr, gerade
Coagulation Suction Tube, straight
Tubo de succion y coagulación, recto

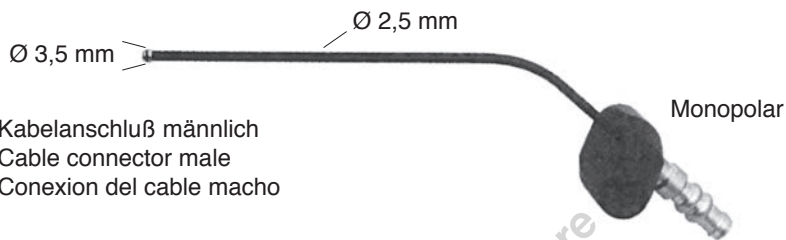

41312-10 Nutzlänge 10 cm, 4"
Working length 10 cm, 4"
Largo útil 10 cm, 4"

41312-26 Nutzlänge 26 cm, 10 □"
Working length 26 cm, 10 □"
Largo útil 26 cm, 10 □"

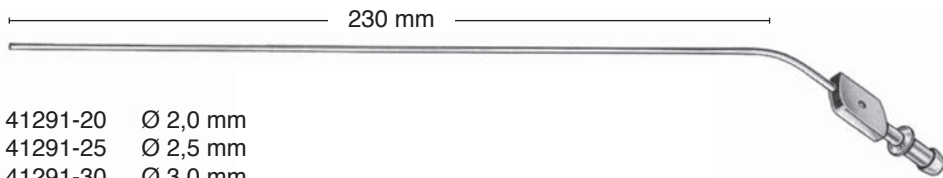

Injektionskanüle, Luer-Lock, Nadelhalter
Injection Needle, Luer-Lock, Needle Holder
Canula de inyeccion, conexion Luer-Lock, Porta-aguja

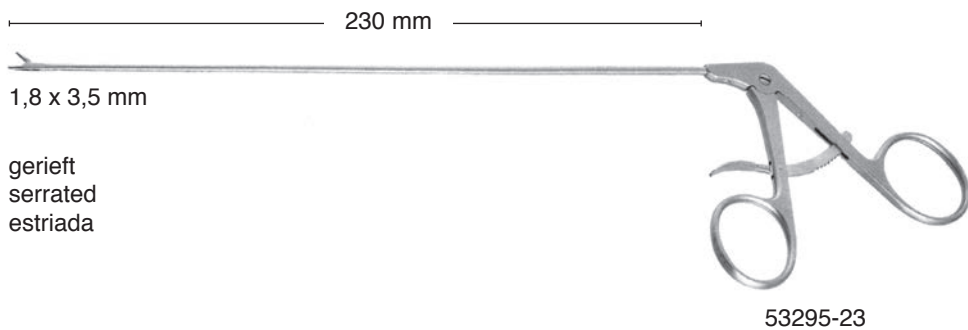
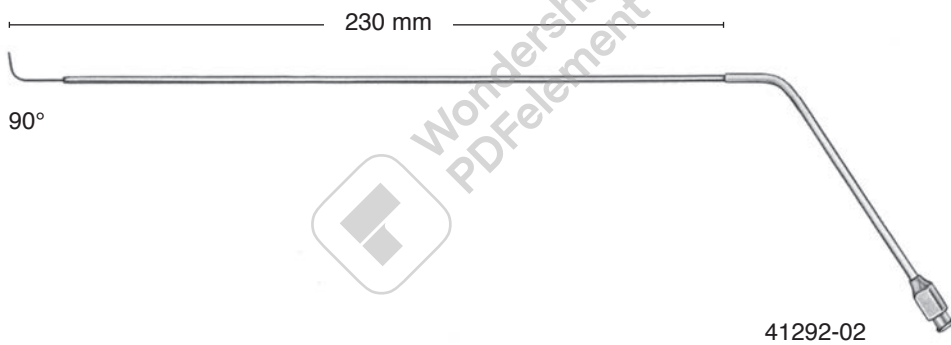
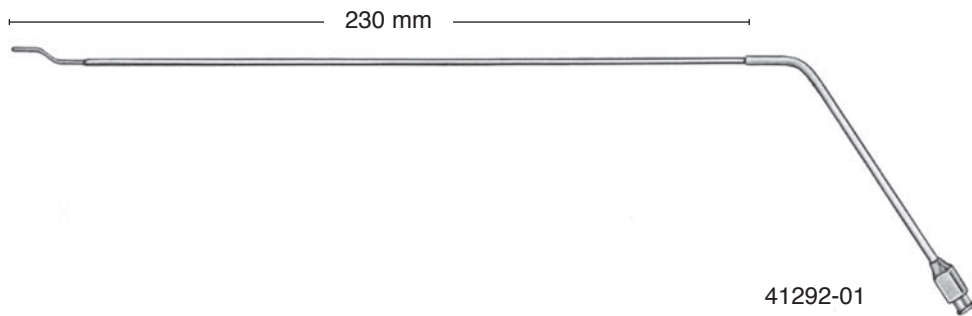

Mikro Rohrschaftzangen
 Micro Laryngeal Forceps
 Micro pinzas con vaina tubular

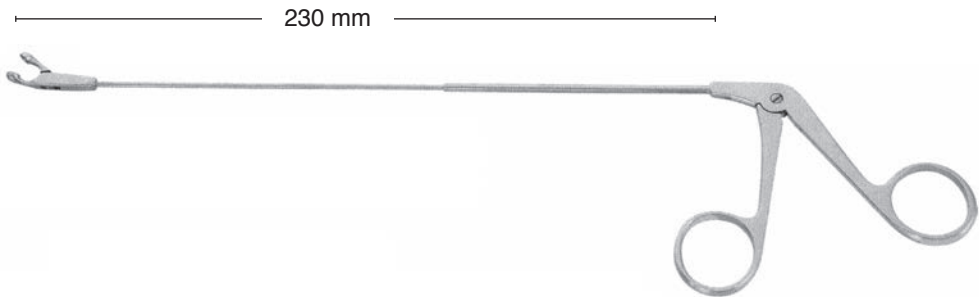

Mikro-Fasszängchen
 Micro Grasping Forceps
 Micro pinzas de agarre

	gerade, gerieft straight, serrated recta, estriada	53280-01 1,5 x 10 mm
	nach links gebogen, gerieft curved to left, serrated curvada hacia la izquierda, estriada	53280-02 1,5 x 8,5 mm
	nach rechts gebogen, gerieft curved to right, serrated curvada hacia la derecha, estriada	53280-03 1,5 x 8,5 mm
	aufgebogen, gerieft curved up, serrated curvada hacia arriba, estriada	53280-16
	dreieckig, gerieft, nach rechts aufgebogen triangular, serrated, curved to right triangulada, estriada, curvada hacia la derecha	53280-17
	dreieckig, gerieft, nach links aufgebogen triangular, serrated, curved to left triangulada, estriada, curvada hacia la izquierda	53280-18





Mikro Rohrschaftzangen
 Micro Laryngeal Forceps
 Micro pinzas con vaina tubular

Mikro-Löffelzangen

Micro Cup Shaped Forceps

Micro pinzas en forma cucharilla





Ø 2 mm Ø 4 mm

	gerade straight recta	53280-04	53280-19
	nach links gebogen curved to left curvada hacia la izquierda	53280-05	53280-20
	nach rechts gebogen curved to right curvada hacia la derecha	53280-06	53280-21
	aufgebogen curved up curvada hacia arriba	53280-07	53280-22



Mikro-Scheren

Micro Scissors

Micro tijeras

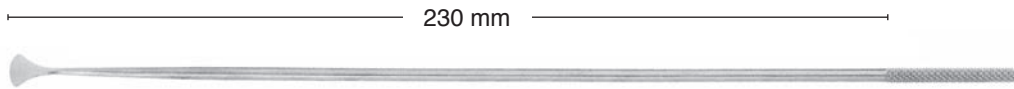



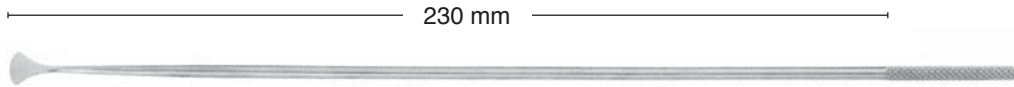

	gerade straight recta		53280-08
	nach links gebogen curved to left curvada hacia la izquierda		53280-09
	nach rechts gebogen curved to right curvada hacia la derecha		53280-10
	gerade horizontal straight horizontal recta horizontal		53280-11
	aufgebogen 45° curved up 45° curvada hacia arriba en 45°		53280-12

Instrumente für Laryngoskopie
 Instruments for Laryngology
 Instrumentos para laringoscopia

	Messer, sichelförmig, gebogen, spitz Knife, sickle shaped, curved, pointed Cuchillo en forma de hoz, agudo, curvo	53290-01
	Messer, oval, gerade Knife, oval, straight Cuchillo, recto, ovalado	53290-02
	Messer, Rundschnittform, vertikal schneidend Knife, round, cuts vertically Cuchillo, corte redondo, corte vertical	53290-03
	Messer, oval 45°, 2,5mm Knife, oval 45°, 2,5 mm Cuchillo, ovalado en 45°, 2,5mm	53290-04
	Häkchen, stumpf 90°, mit Sondenknopf Hook, blunt angled 90° with probe end Ganchito, romo en 90°, abotonado	53290-05
	Häkchen, stumpf, mit Sondenknopf Hook, blunt with probe end Ganchito, romo, abotonado	53290-06
	Knotenführer Knot tier Baja nudos	53290-07

Instrumente für Laryngoskopie
 Instruments for Laryngology
 Instrumentos para laringoscopia



	Messer, gerader Schnitt, spitz Knife, straight cut, pointed Cuchillo, corte recto, agudo	53290-11
	Messer, golfstockförmig, gebogen, rund Knife, golf stick shaped, curved round Cuchillo en forma de golf, curvo, redondo	53290-12
	Häkchen, scharf Hook, sharp Ganchito, agudo	53290-13
	Umstechungsnadel, nach links gebogen Needle, curved to left Aguja, curvada hacia la izquierda	53290-14
	Umstechungsnadel, nach rechts gebogen Needle, curved to right Aguja, curvada hacia la derecha	53290-15
	Saugraspatorium Suction Elevator Legra de succion	53290-16



53290-08
 Handgriff für Stabinstrumente
 Handle for microlaryngeal instruments
 Mango para instrumentos microlaringeos

Universalgriffe, Verlängerungsrohre, Aufsätze
 Universal Handles, Interchangeable Tips, Tubes
 Mangos universales, Tubos de extension, Puntas



BRUENINGS
53131-20
20 cm, 8"



BRUENINGS

- | | | | |
|----------|----------------|----------|----------------|
| 53132-20 | 20 cm, 8" | 53132-50 | 50 cm, 19 1/2" |
| 53132-30 | 30 cm, 11 1/2" | 53132-60 | 60 cm, 23 1/2" |
| 53132-40 | 40 cm, 15 1/2" | | |

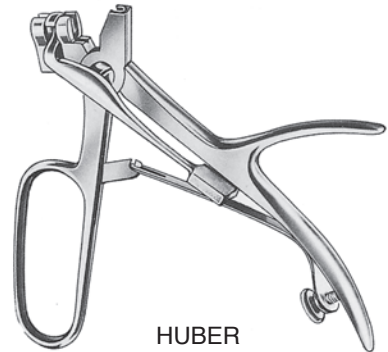

HUBER
53130-00



FRAENKEL
53150-00



SEIFERT
53152-00



FRAENKEL
53154-00



SCHEINMANN
53155-00



SCHEINMANN
53157-00



BRUENINGS
53158-02 - 53158-03



BRUENINGS
53160-02 - 53160-03



LANGE
53162-00



53164-01



53164-02



KRAUSE
53164-01 - 53164-02



KRAUSE
53166-00



SCHUMACHER
53170-00



BARACANI
53175-00



53177-01



53177-02



CORDES
53177-01 - 53177-02



BRONCHOSKOPIE

BRONCHOSCOPY

BRONCOSCOPIA

HADEO
INSTRUMENTE GERMANY

Indikationen und Kontraindikationen finden Sie in der entsprechenden Gebrauchsanweisung!
Indication and Contraindication please refer to our user's manual!
Indicaciones y Contraindicaciones se encuentran en la instrucciones de uso correspondientes!

Broncho-Oesophagoskopiezangen
Broncho-Esophagoscopy Forceps
Pinzas para bronco-esofagoscopia

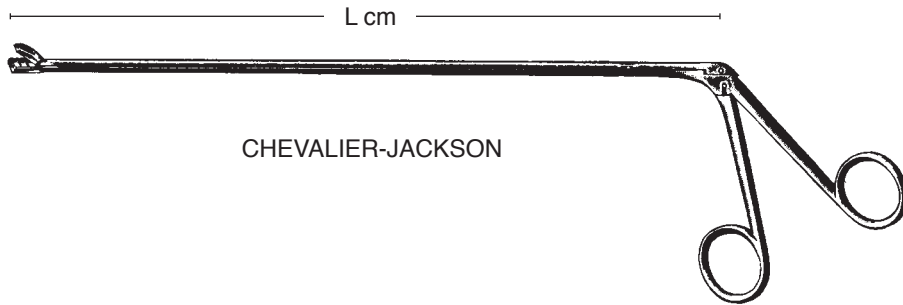

CHEVALIER-JACKSON

	Fig. 1	Fig. 2	Fig. 3	Fig. 4
30 cm / 11 1/4"	53230-01	53230-02	53230-03	53230-04
40 cm / 15 1/4"	53240-01	53240-02	53240-03	53240-04
50 cm / 19 1/4"	53250-01	53250-02	53250-03	53250-04
60 cm / 23 1/4"	53260-01	53260-02	53260-03	53260-04

Ø 4 mm

	Fig. 5	Fig. 6	Fig. 7	Fig. 8
30 cm / 11 1/4"	53230-05	53230-06	53230-07	53230-08
40 cm / 15 1/4"	53240-05	53240-06	53240-07	53240-08
50 cm / 19 1/4"	53250-05	53250-06	53250-07	53250-08
60 cm / 23 1/4"	53260-05	53260-06	53260-07	53260-08

SÄTZE

SET

SET



HADEO
INSTRUMENTE GERMANY

Indikationen und Kontraindikationen finden Sie in der entsprechenden Gebrauchsanweisung!
Indication and Contraindication please refer to our user's manual!
Indicaciones y Contraindicaciones se encuentran en la instrucciones de uso correspondientes!

SET/440:	Grundsieb H NO / Basic set for ENT / Juego basico para ORL	
03180-90	ZIEGLER head mirror 90mm	1x1
45246-14	ear forceps, HARTMANN 14cm	1x1
45206-14	ear forceps bayonet, LUCAE 14cm, without teeth	1x1
65110-15	tissue forceps, ALLIS 4x5 teeth, 15cm	1x1
17170-25	swab forceps serrated, FOERSTER straight, 25cm	1x1
45010-00	ear specula set of 4, HARTMANN	1x1
09304-14	operating sciss.fine, JOSEPH straight, 14,0cm	1x1
09305-14	operating sciss.fine, JOSEPH curved, 14,5cm	1x1
25137-11	BABY WEBSTER Needle Holder 4 3/4 TC smooth	1x1
45110-00	ear curette, BUCK straight, blunt, Fig. 0	1x1
45110-01	ear curette, BUCK straight, blunt, Fig. 1	1x1
45097-10	ear syringe complete, REINER 100ml	1x1
45150-18	paracentesis needle, POLITZER bajonet, 18cm	1x1
41299-03	Suction Tube Baron 3Fr	1x1
41299-05	suction tubes Baron 5Fr.	1x1
41299-07	suction tube, BARON 7 Fr.	1x1
45180-02	ear loop, BILLEAU, Fig.2, 16cm	1x1
45190-01	ear hooklet small, DAY, Fig. 1, 16cm	1x1
47112-01	nasal speculum, MOD.VIENNA for babies	1x1
47112-02	nasal speculum, MOD.VIENNA for children	1x1
47112-03	nasal speculum, MOD.VIENNA for adults	1x1
49107-19	tongue depressor, BRUENINGS 19cm	2x1
49265-14	mouth gag, DOYEN-JANSEN (Molt) 14cm	1x1
45072-01	Tuning forks w. foot, A1-440	1x1
21272-14	cotton applicators, FARREL triangular, 14cm	1x1
45193-01	hooklet, LUCAE Fig. 1	1x1
45206-16	ear forceps bayonet, LUCAE without teeth, 16cm	1x1
45261-08	ear polypus forceps, HARTMANN 8,5cm	1x1
45271-08	ear forceps, STRUEMPEL D. 2,5 x 5mm, 8,5cm	1x1
11102-14	forceps dressing, 14,5cm	1x1
11120-14	forceps tissue 1x2 t. 14,5 cm	1x1
47351-26	nasal snare angled, KRAUSE 26cm	1x1
47355-03	loops 0,3 mm bundle of 12 ea.	1x1
47332-25	EICKEN (KILLIAN) antrum cannula 2.5mm	1x1
43614-00	BOWMAN lachrymal probe, Fig. 00/0, 0,7/0,8mm Ø	1x1
43614-12	BOWMAN lachrymal probe, Fig. 1/2, D. 0,9/1,1mm	1x1
07103-00	scalpel handle no. 3 12,5cm	1x1
89142-02	jar 50 x 100mm	1x1
53272-10	laryngeal mirror with handle Fig. 0, D. 10mm	5x1
53272-12	laryngeal mirror with handle Fig. 1, D. 12mm	5x1
53272-16	laryngeal mirror with handle Fig. 3, D. 16mm	3x1
53272-18	laryngeal mirror with handle Fig. 4, D. 18mm	3x1
51290-02	tonsil syringe 3 rings LL 2ml	1x1
51292-00	tonsil injection needle straight	1x1
45097-10	ear syringe complete, REINER 100ml	1x1
89139-25	Kidney bowl medium 250 x 140 x 40mm	1x1

SET/443:	Myringotomie Set / Myringotomie Set / Juego para miringotomia	
45010-55	ear specula, HARTMANN D. 5,5mm	1x1
45010-65	ear specula, HARTMANN D. 6,5mm	1x1
45010-75	ear specula, HARTMANN D. 7,5mm	1x1
45350-70	ear forceps micro serrated 7mm x 8cm	1x1
45110-01	ear curette, BUCK straight, blunt, Fig. 1	1x1
45165-17	ear knife, SEXTON angled, 17cm	1x1
45151-16	paracentesis needle, POLITZER angled, 16,5cm	1x1
45713-15	needle, BARBARA curved pointed	1x1
45724-10	hooklet, BARBARA 90° angled, 1,0mm	1x1
45180-02	ear loop, BILLEAU, Fig.2, 16cm	1x1
45192-02	hooklet , WAGENER Fig. 2, 14cm	1x1
21272-14	cotton applicators, FARREL triangular, 14cm	1x1
41305-07	suction tubes, ROSEN D. 0,7mm	1x1
41305-09	suction tubes, ROSEN D. 0,9mm	1x1
41305-12	suction tubes, ROSEN D. 1,2mm	1x1
41307-00	WULLSTEIN suction handle for Rosen cann.	1x1
45206-14	ear forceps bayonet, LUCAE 14cm, without teeth	1x1
45246-12	ear forceps, HARTMANN, 12cm	1x1
45255-08	ear polypus forceps, WULLSTEIN 8,5cm	1x1



SET/441:	Set für Mastoidektomie / Mastoidectomy Set / Juego para mastoidectomia	
07103-00	scalpel handle no. 3 12,5cm	1x1
47102-02	nasal speculum, HARTMANN-HALLE Fig. 2	1x1
19670-16	retractor, WEITLANER sharp, 16,5cm	1x1
19670-14	retractor, WEITLANER sharp, 14,0cm	1x1
19654-13	retractor, WEITLANER-WULLSTEIN sharp, 13cm	1x1
19280-03	retractor, VOLKMANN pointed, 21,5cm, 3 teeth	2x1
19312-02	retractor, LANGENBECK 21cm, 30x14mm	2x1
33702-15	periosteal elevator, FARABEUUF straight, 15cm, 12,5mm	1x1
45807-20	elevator, LEMPERS 20.5cm	1x1
47415-18	FREER septum elevator, 18cm double ended, sharp/blunt	1x1
33605-04	gouge 13,5cm, 4mm	1x1
33605-06	gouge 13.5cm x 6mm	1x1
33605-08	gouge 13,5cm, 8mm	1x1
33602-04	osteotome 13,5cm, 4mm	1x1
33602-06	osteotome 13,5cm, 6mm	1x1
33602-08	osteotome 13,5cm, 8mm	1x1
33700-05	hammer, COTTLE flat/convex D. 30mm, 240gr., 18cm	1x1
47303-03	punch, KERRISON 17cm, shaft 85mm, 3x3mm	1x1
33156-18	bone rongeur, BEYER 18cm	1x1
45760-01	curette, HOUSE 1,0 / 1,2mm	1x1
33490-20	bone curette, LEMPERS 17,5cm, Fig. 00	1x1
33475-00	bone curette, SPRATT 17cm, Fig. 0	1x1
33475-01	bone curette, SPRATT 17cm, Fig. 1	1x1
13221-12	hemost.fcps.,HALSTED-MOSQUITO curved, 12,0cm	4x1
13310-14	hemost.fcps. ,ROCHESTER-PEAN straight, 14cm	4x1
13311-14	hemost.fcps. ,ROCHESTER-PEAN curved,14cm	4x1
13320-14	hemost.fcps.,ROCHESTER-OCHSNER 1x2 teeth, straight, 14cm	2x1
65110-15	tissue forceps, ALLIS 4x5 teeth, 15cm	2x1
11170-12	forceps dressing serr., ADSON 12cm	1x1
11180-12	forceps tissue 1x2 t.,ADSON 12cm	1x1
11188-12	forceps tissue, ADSON-BROWN 7x7 teeth, 12cm	1x1
11102-14	forceps dressing, 14,5cm	1x1
11120-14	forceps tissue 1x2 t. 14,5 cm	1x1
21320-18	cotton applicator,JOHNSON-HORNE 18cm	1x1
09341-10	operating sciss.fine, IRIS curved, 10cm	1x1
09363-11	scissors, STEVENS blunt/blunt, curved 11cm	1x1
09305-14	operating sciss.fine, JOSEPH curved, 14,5cm	1x1
09283-15	diss.scissors,METZENBAUM-FINO curved, 15cm	1x1
09110-14	operating scissors, STANDARD pointed/blunt, straight 14,5cm	1x1
41299-03	Suction Tube Baron 3Fr	1x1
41299-05	suction tubes Baron 5Fr.	1x1
41299-07	suction tube, BARON 7 Fr.	1x1
41295-06	suction tube, FRAZIER/FERGUSSON 19cm, 30°, Charr. 6	1x1
41295-08	suction tube, FRAZIER/FERGUSSON 19cm, 30°, Charr. 8	1x1
41295-10	suction tube, FRAZIER/FERGUSSON 19cm, 30°, Charr. 10	1x1
41307-00	WULLSTEIN suction handle for Rosen cann.	1x1
41305-05	suction tubes, ROSEN D. 0,5mm	2x1

41305-08	Rosen Suction Tube 0,8mm	2x1
41305-09	suction tubes, ROSEN D. 0,9mm	2x1
41305-12	suction tubes, ROSEN D. 1,2mm	2x1
25144-13	needle holder, HALSEY serrated, TC, 13cm	1x1
25164-15	needle holder, CRILE-WOOD serrated, TC, 15cm	1x1
15111-09	towel forceps, BACKHAUS 9cm	6x1
17110-20	dressing forceps, GROSS-MAIER straight, 20cm	1x1
89127-08	Bowl round, stainless steel 80 x 40mm, 0,14 l. (5,6 OZ)	1x1
89127-06	round bowl 61x30mm, 0.07 ltr	1x1



SET/442:	Set für Mikrochirurgie (Ohr) / Set for Ear Micro Surgery / Juego para micro otologia	
47103-03	nasal specula HARTMANN Fig. 3	1x1
45803-16	elevator, LEMPERT curved, 16cm, 2mm	1x1
33718-16	periosteal elevator, JOSEPH 16cm, 4mm	1x1
11120-11	forceps tissue 1x2 t. 11,5 cm	1x1
11260-15	forceps dressing, SEMKEN 15,5cm	1x1
09141-14	dissecting scissors, DEAVER pointed/blunt, curved, 14,5cm	1x1
19677-13	Plester retractor, 13cm 2x2t., sharp	2x1
19673-11	retractor, PLESTER blunt, 11cm	1x1
19672-11	retractor, PLESTER blunt, 11cm	1x1
19283-01	WILLIGER, wound retractor, 12cm 3 teeth, sharp, straight	1x1
07103-00	scalpel handle no. 3 12,5cm	2x1
09111-14	operating scissors, STANDARD pointed/blunt, curved, 14,5cm	1x1
13310-14	hemost.fcps. , ROCHESTER-PEAN straight, 14cm	1x1
25129-13	needle holder, WEBSTER TC smooth, 13cm	1x1
13220-12	hemost.fcps., HALSTED-MOSQUITO straight, 12,5cm	1x1
13221-12	hemost.fcps., HALSTED-MOSQUITO curved, 12,0cm	2x1
15111-09	towel forceps, BACKHAUS 9cm	6x1
09340-10	operating sciss.fine, IRIS straight, 10cm	1x1
R065-040125-003	Bipolar connecting cable 3 mtr. long for Erbe / Storz HF-generators european flat plug f. instruments	1x1
45010-55	ear specula, HARTMANN D. 5,5mm	1x1
45010-65	ear specula, HARTMANN D. 6,5mm	1x1
45010-75	ear specula, HARTMANN D. 7,5mm	1x1
45350-70	ear forceps micro serrated 7mm x 8cm	1x1
45255-08	ear polypus forceps, WULLSTEIN 8,5cm	1x1
45261-08	ear polypus forceps, HARTMANN 8,5cm	1x1
45362-45	ear fcps.micro spoon oval 4,5mm, straight	1x1
45267-20	ear polypus forceps, HARTMANN D. 2,0mm, 8,5cm	1x1
45310-40	ear scissors micro, BELLUCCI micro mini, 4mm	1x1
45387-01	DIETER, malleurs punches upwards cutting, Ø 1,8mm, 8cm	1x1
45371-40	McGEE, wire bending forceps 0,8 x 4,0mm, 8cm	1x1
41305-10	suction tubes, ROSEN D. 1,0mm	4x1
41305-07	suction tubes, ROSEN D. 0,7mm	4x1
41305-12	suction tubes, ROSEN D. 1,2mm	4x1
41305-15	suction tubes, ROSEN D. 1,5mm	4x1
41305-20	suction tubes, ROSEN D. 2,0mm	4x1
41307-00	WULLSTEIN suction handle for Rosen cann.	1x1
41304-06	suction tubes, PLESTER 30°, Charr.6	1x1
41304-08	suction tubes, PLESTER 30°, Charr.8	1x1
41304-10	suction tubes, PLESTER 30°, Charr.10	1x1
45190-02	ear hooklet medium, DAY, Fig. 2, 16cm	1x1
45192-03	hooklet , WAGENER Fig. 3, 14cm	1x1
45111-00	ear curette Buck straight, sharp, Fig. 00	1x1
45112-00	ear curette Buck straight, sharp, Fig. 0	1x1
45748-16	hook, reverse cutting, 0,6mm/16cm	1x1
45760-01	curette, HOUSE 1,0 / 1,2mm	2x1

45760-02	curette, HOUSE 1,5 / 1,8mm	2x1
45749-16	PLESTER, footplate hook, 16cm 90°angled, oval-blunt	1x1
45722-06	hooklet, BARBARA 45° angled, 0,6mm	1x1
45724-03	hooklet, BARBARA 90° angled, 0,3mm	2x1
45724-06	hooklet, BARBARA 90° angled, 0,6mm	2x1
45771-16	fork PLESTER, 16cm, width 0,6mm	1x1
45722-10	hooklet, BARBARA 45° angled, 1,0mm	1x1
45706-35	Round knife, PLESTER 15,5cm, size 3,5mm	2x1
45709-20	knife circular, ROSEN 2mm	2x1
45704-15	sickle knife, WULLSTEIN 15,5cm	2x1
45713-15	needle, BARBARA curved pointed	2x1
45724-10	hooklet, BARBARA 90° angled, 1,0mm	1x1
91127-16	bipolar forceps angled 1mm, 16,5cm	1x1
89127-08	Bowl round, stainless steel 80 x 40mm, 0,14 l. (5,6 OZ)	1x1



SET/444:	Set für Ohrmuschel - Operation / Set for Otoplasty Surgery / Juego para cirugía otoplastica	
07103-00	scalpel handle no. 3 12,5cm	1x1
09341-10	operating sciss.fine, IRIS curved, 10cm	1x1
09305-14	operating sciss.fine, JOSEPH curved, 14,5cm	1x1
09358-11	Cottle bulldog-scissors cvd., 11,5cm	1x1
09111-14	operating scissors, STANDARD pointed/blunt, curved, 14,5cm	1x1
11130-11	Tissue Fcps 1x2 teeth 11cm fine	1x1
11188-12	forceps tissue, ADSON-BROWN 7x7 teeth, 12cm	1x1
11102-14	forceps dressing, 14,5cm	1x1
11120-14	forceps tissue 1x2 t. 14,5 cm	1x1
21272-14	cotton applicators, FARREL triangular, 14cm	1x1
47530-01	DINGMAN nasal rasp 15cm, left # 1	1x1
47530-02	DINGMAN nasal rasp 15cm right # 2	1x1
47380-15	nasal plastic knife, COTTLE 15cm	1x1
47415-18	FREER septum elevator, 18cm double ended, sharp/blunt	1x1
47451-04	septum chisel, FREER 4mm, curved	1x1
47562-18	hooklet delicate, GILLIES 18cm Fig. 2	1x1
19216-05	hooklet sharp 2 prong, JOSEPH 5mm, 16cm	1x1
19221-02	retractor (trach.) blunt 2 prongs, 16cm	1x1
89148-25	medicine cup 25 CC	1x1
51290-05	tonsil syringe 3 ring LL 5ml	1x1
41295-10	suction tube, FRAZIER/FERGUSSON 19cm, 30°, Charr. 10	1x1
41295-08	suction tube, FRAZIER/FERGUSSON 19cm, 30°, Charr. 8	1x1
13221-12	hemost.fcps., HALSTED-MOSQUITO curved, 12,0cm	6x1
13240-14	hemost.fcps. , KELLY straight, 14cm	1x1
11190-10	forceps, GRAEFE 10,5cm	1x1
43810-10	GRAEFE iris forceps, anatomic, straight, 10cm	1x1
13310-14	hemost.fcps. , ROCHESTER-PEAN straight, 14cm	1x1
15111-09	towel forceps, BACKHAUS 9cm	6x1
25144-13	needle holder, HALSEY serrated, TC, 13cm	1x1
91122-16	bipolar forceps pointed straight, 16,5cm total long	1x1
R065-040125-005	Bipolar connecting cable 5mtr. long for Erbe / Storz HF-generators european plug for instruments	1x1

SET/445:	Satz zur Mittelohr- Chirurgie, Tympanoplastik und Stapedektomie / Set for tympanic and stapedectomy / Juego para cirugía de timpano y estapedectomía	
19654-13	retractor, WEITLANER-WULLSTEIN sharp, 13cm	1x1
19672-11	retractor, PLESTER blunt, 11cm	1x1
19673-11	retractor, PLESTER blunt, 11cm	1x1
19677-13	Plester retractor, 13cm 2x2t., sharp	1x1
47120-50	Nasal speculum, KILLIAN 50mm	1x1
45010-55	ear specula, HARTMANN D. 5,5mm	1x1
07103-00	scalpel handle no. 3 12,5cm	1x1
07109-15	scalpel handle MINI 15,5cm	1x1
47451-04	septum chisel, FREER 4mm, curved	1x1
45802-16	elevator, LEMPERS straight, 16cm, 2mm	1x1
41305-12	suction tubes, ROSEN D. 1,2mm	1x1
41305-15	suction tubes, ROSEN D. 1,5mm	1x1
41305-20	suction tubes, ROSEN D. 2,0mm	1x1
41307-00	WULLSTEIN suction handle for Rosen cann.	1x1
45709-10	knife circular, ROSEN 1.0mm	1x1
45724-06	hooklet, BARBARA 90° angled, 0,6mm	1x1
45724-10	hooklet, BARBARA 90° angled, 1,0mm	1x1
45724-15	hooklet, BARBARA 90° angled, 1,5mm	1x1
45724-25	hooklet, BARBARA 90° angled, 2,5mm	1x1
45766-40	Micro Measuring Rod, HOUSE 4.0mm	1x1
45766-50	Micro Measuring Rod, HOUSE 5.0mm	1x1
11120-11	forceps tissue 1x2 t. 11,5 cm	1x1
11120-14	forceps tissue 1x2 t. 14,5 cm	1x1
11405-05	forceps, jeweller Fig. 5 11cm, 0.15mm	1x1
11170-12	forceps dressing serr., ADSON 12cm	1x1
09285-12	dissecting sciss., METZENBAUM curved, TC 12,0cm	1x1
09340-10	operating sciss.fine, IRIS straight, 10cm	1x1
09358-11	Cottle bulldog-scissors cvd., 11,5cm	1x1
09111-14	operating scissors, STANDARD pointed/blunt, curved, 14,5cm	1x1
13221-12	hemost.fcps., HALSTED-MOSQUITO curved, 12,0cm	1x1
25164-15	needle holder, CRILE-WOOD serrated, TC, 15cm	1x1
45706-35	Round knife, PLESTER 15,5cm, size 3,5mm	1x1
45722-10	hooklet, BARBARA 45° angled, 1,0mm	1x1
45757-16	dissector, FISCH right, 16cm	1x1
45755-16	dissector, FISCH left, 16cm	1x1
45704-15	sickle knife, WULLSTEIN 15,5cm	1x1
45724-03	hooklet, BARBARA 90° angled, 0,3mm	1x1
45724-06	hooklet, BARBARA 90° angled, 0,6mm	1x1
45724-10	hooklet, BARBARA 90° angled, 1,0mm	1x1
21108-14	probe myrtle leaf 14,5 cm	1x1
45371-40	McGEE, wire bending forceps 0,8 x 4,0mm, 8cm	1x1
45362-45	ear fcps.micro spoon oval 4,5mm, straight	1x1
45267-20	ear polypus forceps, HARTMANN D. 2,0mm, 8,5cm	1x1
45255-08	ear polypus forceps, WULLSTEIN 8,5cm	1x1
45310-40	ear scissors micro, BELLUCCI micro mini, 4mm	1x1
45315-55	ear scissors micro, BELLUCCI micro stanard, 5,5mm, curved right	1x1
45317-55	ear scissors micro, BELLUCCI micro standard, 5,5mm, curved left	1x1
45324-03	FISCH, ear scissors, cvd. right 3,0x0,75x2,0mm, 8cm	1x1
45325-03	FISCH, ear scissors, cvd. left 3,0x0,75x2,0mm, 8cm	1x1

SET/450:	Nasenseptumsatz / Nasal Septum set / Juego para el septo nasal	
47102-03	nasal speculum, HARTMANN-HALLE Fig. 3	1x1
47120-50	Nasal speculum, KILLIAN 50mm	1x1
47120-75	nasal speculum, KILLIAN 75mm	1x1
47120-90	nasal speculum, KILLIAN 90mm	1x1
09341-11	operating sciss.fine, IRIS curved, 11cm	1x1
09305-14	operating sciss.fine, JOSEPH curved, 14,5cm	1x1
09350-10	Graefe scissors, 10cm fine pattern	1x1
47223-01	WEIL-BLAKESLEY nose forceps shaft 120mm, straight, 3.0mm, Fig.1	1x1
47242-00	nasal cutting fcps, TAKAHASHI shaft 120mm, 4x10mm tip, straight	1x1
09401-18	scissors nasal, HEYMANN 18cm	1x1
47159-20	LUBET-BARBON nasal dressing forceps, 20cm	1x1
41295-08	suction tube, FRAZIER/FERGUSON 19cm, 30°, Charr. 8	1x1
49107-19	tongue depressor, BRUENINGS 19cm	1x1
47565-10	COTTLE columella forcep 10cm	1x1
11188-12	forceps tissue, ADSON-BROWN 7x7 teeth, 12cm	1x1
11190-10	forceps, GRAEFE 10,5cm	1x1
11102-14	forceps dressing, 14,5cm	1x1
11120-14	forceps tissue 1x2 t. 14,5 cm	1x1
45206-16	ear forceps bayonet, LUCAE without teeth, 16cm	1x1
21270-14	cotton applicators, FARREL threaded, 14cm	2x1
47380-15	nasal plastic knife, COTTLE 15cm	1x1
47554-01	retractor, COTTLE Fig. 1 14.5cm	1x1
47410-04	septum elevator, McKENTY 15cm, 4mm	1x1
33700-05	hammer, COTTLE flat/convex D. 30mm, 240gr., 18cm	1x1
47415-18	FREER septum elevator, 18cm double ended, sharp/blunt	1x1
47454-04	rhinoplastic osteotome, COTTLE 18cm, straight, 4mm	1x1
47454-07	rhinoplastic osteotome, COTTLE 18cm, straight, 7mm	1x1
47423-22	septum elevator, COTTLE 22cm	1x1
25214-18	needle holder, DE-BAKEY serrated, TC, 18cm	1x1
15111-09	towel forceps, BACKHAUS 9cm	6x1
47351-26	nasal snare angled, KRAUSE 26cm	1x1
47355-03	loops 0,3 mm bundle of 12 ea.	1x1
47385-15	nasal plastic knife, JOSEPH 15cm curved	1x1
89127-08	Bowl round, stainless steel 80 x 40mm, 0,14 l. (5,6 OZ)	1x1
33720-19	periosteal elevator, BOIES 19cm, 9mm	1x1
91122-16	bipolar forceps pointed straight, 16,5cm total long	1x1

SET/451:	Rhinoplastiksatz / Rhinoplasty Set / Juego para rinoplastia	
07109-15	scalpel handle MINI 15,5cm	1x1
07103-00	scalpel handle no. 3 12,5cm	1x1
47380-15	nasal plastic knife, COTTLE 15cm	1x1
21272-14	cotton applicators, FARREL triangular, 14cm	2x1
09341-11	operating sciss.fine, IRIS curved, 11cm	1x1
09305-14	operating sciss.fine, JOSEPH curved, 14,5cm	1x1
09617-13	Rhinoplastic scissors, FOMON curved, 13cm	1x1
09401-18	scissors nasal, HEYMANN 18cm	1x1
47454-04	rhinoplastic ostetome, COTTLE 18cm, straight, 4mm	1x1
47454-07	rhinoplastic osteotome, COTTLE 18cm, straight, 7mm	1x1
47473-01	rhinoplastic chisel, SILVER 18cm, straight	1x1
47473-02	rhinoplastic chisel, SILVER 18cm, curved right	1x1
47473-03	rhinoplastic chisel, SILVER 18cm, curved left	1x1
47554-01	retractor, COTTLE Fig. 1 14.5cm	1x1
47556-16	FOMON Alar Hooklet 16cm	1x1
47559-20	hooklet, COTTLE-NEIVERT double, 20cm	1x1
47551-16	nasal retracator, AUFRICHT 16cm	1x1
47423-22	septum elevator, COTTLE 22cm	1x1
47426-22	septum elevator, KILLIAN 22cm	1x1
47410-04	septum elevator, MCKENTY 15cm, 4mm	1x1
45206-14	ear forceps bayonet, LUCAE 14cm, without teeth	1x1
11188-12	forceps tissue, ADSON-BROWN 7x7 teeth, 12cm	1x1
47522-01	nasal rasp, FOMON 20cm, Fig. 1/2 TC	1x1
47522-04	nasal rasp, FOMON 20cm, Fig. 3/4 TC	1x1
47571-23	septum straight.fcps., ASCH 23cm	1x1
33700-05	hammer, COTTLE flat/convex D. 30mm, 240gr., 18cm	1x1
47532-19	nasal saw, JOSEPH 19cm, left	1x1
47534-19	nasal saw, JOSEPH 19cm, right	1x1
47120-75	nasal speculum, KILLIAN 75mm	1x1
47120-90	nasal speculum, KILLIAN 90mm	1x1
47223-01	WEIL-BLAKESLEY nose forceps shaft 120mm, straight, 3.0mm, Fig. 1	1x1
47223-03	forceps, WEIL-BLAKESLEY shaft 120mm, straight, 4.2mm, Fig. 3	1x1
47461-00	COTTLE cartilage crusher	1x1
47255-01	nasal cut.fcps WATSON-WILLIAMS 7mm jaw straight, 120mm working lenth	1x1
25164-15	needle holder, CRILE-WOOD serrated, TC, 15cm	1x1
25164-18	needle holder, CRILE-WOOD serrated, TC, 18cm	1x1
41295-08	suction tube, FRAZIER/FERGUSSON 19cm, 30°, Charr. 8	1x1
41295-10	suction tube, FRAZIER/FERGUSSON 19cm, 30°, Charr. 10	1x1
47565-10	COTTLE columella forcep 10cm	1x1
47411-16	septum elevator, JOSEPH 16cm	1x1
47390-03	swivel knife, BALLENGER straight, 20cm, 3mm	1x1
47380-15	nasal plastic knife, COTTLE 15cm	1x1
33282-19	bone cut.fcps, COTTLE-KAZANJIAN 19cm	1x1
19216-02	hooklet sharp 2 prong, JOSEPH 2mm, 16cm	1x1
47323-19	septum fcps, MIDDLETON-JANSEN 19cm	1x1

SET/452:	Endonasaler Satz / Endonasal set / Juego endonasal	
41295-08	suction tube, FRAZIER/FERGUSSON 19cm, 30°, Charr. 8	1x1
41295-10	suction tube, FRAZIER/FERGUSSON 19cm, 30°, Charr. 10	1x1
45160-15	ear knife, POLITZER 15cm	1x1
47223-01	WEIL-BLAKESLEY nose forceps shaft 120mm, straight, 3.0mm, Fig. 1	1x1
47223-02	forceps, WEIL-BLAKESLEY shaft 120mm, straight, 3.6mm, Fig. 2	1x1
47223-03	forceps, WEIL-BLAKESLEY shaft 120mm, straight, 4.2mm, Fig. 3	1x1
47224-01	forceps, WEIL-BLAKESLEY shaft 120mm, 45° upcurved, size 1 3,0mm	
47224-02	forceps, WEIL-BLAKESLEY shaft 120mm, curved up, Fig. 2	1x1
47120-35	nasal speculum, KILLIAN 35mm	1x1
47120-50	Nasal speculum, KILLIAN 50mm	1x1
47120-75	nasal speculum, KILLIAN 75mm	1x1
47320-00	Biopsy fcps. with cup jaws	1x1
47195-01	nasal cutting forceps, LUC 19cm Fig. 1	1x1
47240-19	nasal cutting fcps., STRUYCKEN shaft 120mm, tip width 1,0mm	1x1
47315-00	OSTROEM Antrum punch up cutting, 2mm 100mm working length	1x1
09401-18	scissors nasal, HEYMANN 18cm	1x1
47305-01	nasal scissors, str. 11cm	1x1
47332-30	EICKEN (KILLIAN) antrum cannula 3.0mm long curved, 14cm long, stainless steel	1x1
47332-25	EICKEN (KILLIAN) antrum cannula 2.5mm long curved, 14cm long, stainless steel	1x1
47423-22	septum elevator, COTTLE 22cm	1x1
47158-20	WESTMACOTT nasal dressing forceps, 20cm	1x1

SET/453:	Satz für die endoskopische Nasennebenhöhlen- Chirurgie / Set for Endoscopic Paranasal Sinus / Juego para cirugía endoscópica del seno paranasal	
23181-40	Sinoscopy-trocar 5mm Ø, oblique beak 8,5cm long, f. endoscope 4mm Ø w. pyramidal trocar and obturator	1x1
47103-02	nasal specula HARTMANN Fig. 2	1x1
R500-040175-000	Sinuscope 4mm Ø, 0° angle of view autoclavable, intergrated fiber optic for illumination, 175mm work.length	1x1
R500-040175-030	Sinuscope 4mm Ø, 30° angle of view autoclavable, intergrated fiber optic f. illumination, 175mm work.length	1x1
91159-19	bipolar forceps angled 2mm, 19,5cm	1x1
51293-45	tonsil injection needle 45° angled	1x1
47580-19	Sickle knife 19cm long, pointed	1x1
47415-18	FREER septum elevator, 18cm double ended, sharp/blunt	1x1
47399-01	Antrum spoon 55° 19cm	1x1
47399-02	Antrum spoon, 90°, 19cm	1x1
47388-04	Antrum curette, curved, 20cm/2,5mm, 30° oval	1x1
47423-22	septum elevator, COTTLE 22cm	1x1
41295-08	suction tube, FRAZIER/FERGUSSON 19cm, 30°, Charr. 8	1x1
41295-10	suction tube, FRAZIER/FERGUSSON 19cm, 30°, Charr. 10	1x1
47332-25	EICKEN (KILLIAN) antrum cannula 2.5mm long curved, 14cm long, stainless steel	1x1
47332-30	EICKEN (KILLIAN) antrum cannula 3.0mm long curved, 14cm long, stainless steel	1x1
47324-01	Maxillary antrum grasping forceps, straight, 90° backward opening, rigid jaw, working length 100mm	1x1
47223-30	nose forceps BLAKESLEY, straight, 3,0mm, working length 130mm	1x1
47223-35	nose forceps BLAKESLEY, straight, 3,5mm, working length 130mm	1x1
47224-30	nose forceps BLAKESLEY, 45° curved up, 3mm, working length 130mm	1x1
47305-01	nasal scissors, str. 11cm	1x1
47317-70	Sinoscopy forceps, shaft length 12cm, horizontal cutting, oval, 70°	1x1
47318-70	Sinoscopy forceps, shaft length 12cm, vertical cutting, oval, 70°	1x1
47320-00	Biopsy fcps. with cup jaws	1x1
47315-00	OSTROEM Antrum punch up cutting, 2mm 100mm working length	1x1
47316-00	OSTROEM Antrum-punch right cutting, 2mm 100mm working length	1x1
47317-00	OSTROEM Antrum-punch left cutting, 2mm 100mm working length	1x1
47240-19	nasal cutting fcps.,STRUYCKEN shaft 120mm, tip width 1,0mm	1x1
47319-35	circular fcps. straight, dia. 3,5mm cutting 360°	1x1
47320-45	circular fcps. 4,5mm Ø, 65° upcurved	1x1

SET/460:	Tonsillektomie-Adenotomie Satz / Tonsillectomy and Adenoidectomy Set / Juego para amigdalactomia y adenotomia	
49342-01	tongue depress.,RUSSEL-DAVIS 29 x 67mm	1x1
49342-02	tongue depress.,RUSSEL-DAVIS 33 x 75mm	1x1
49342-03	tongue depress.,RUSSEL-DAVIS 38 x 85mm	1x1
49340-00	mouth gag only, DAVIS-MEYER	1x1
49111-15	tongue depressor, HARTMANN 15cm	1x1
47235-09	nasal cutting forceps,HARTMANN 9mm	1x1
49107-19	tongue depressor, BRUENINGS 19cm	1x1
53272-14	laryngeal mirror with handle Fig. 2, D. 14mm	1x1
53272-20	laryngeal mirror with handle Fig. 5, D. 20mm	1x1
51292-00	tonsil injection needle straight	1x1
51290-05	tonsil syringe 3 ring LL 5ml	1x1
15111-09	towel forceps, BACKHAUS 9cm	6x1
89127-08	Bowl round, stainless steel 80 x 40mm, 0,14 l. (5,6 OZ)	1x1
51256-28	tonsil snare, BRUENINGS 28cm	1x1
51259-04	tonsil loops 0,4mm Ø, pack of 12 pcs.	1x1
51209-20	tonsil seizing forceps,BLOHMKE 20cm	1x1
51205-18	tonsil seizing fcps, WHITE 18cm	1x1
09435-18	tonsil scissors, BOETTCHER curved, 18cm	1x1
05150-27	aspiration tube, YANKAUER complete, 27cm	1x1
51135-01	tonsil elevator, HENKE Fig. 1, 23cm	1x1
51183-19	tonsil forceps, SCHNIDT 19cm curved	1x1
13551-20	peritoneum forceps, MIKULICZ 20cm 1x2 teeth	1x1
11102-20	forceps dressing, 20cm	1x1
11120-20	forceps tissue 1x2 teeth, 20cm	1x1
47630-00	adenoid curette, BARNHILL 21cm, Fig. 0	1x1
47630-01	adenoid curette, BARNHILL 21cm, Fig. 1	1x1
47630-02	adenoid curette, BARNHILL 21cm, Fig. 2	1x1
47630-03	adenoid curette, BARNHILL 21cm, Fig. 3	1x1
47630-04	adenoid curette, BARNHILL 21cm, Fig. 4	1x1
51131-22	tonsil dissector, HURD 22cm	1x1
25214-18	needle holder, DE-BAKEY serrated, TC, 18cm	1x1
47245-01	naso-pharyngeal fcps. JURASZ 21cm, Fig.1	1x1
91154-19	bipolar forceps, 1mm tipstraight, 19,5cm long european flat connector	1x1

SET/470:	Laryngoskopiesatz für Erwachsene / Laryngoscopy Set for Adults / Juego de laringoscopia para adultos	
05301-04	operation laryng.,KLEINSASSER 170x28,5x18,5x15mm	1x1
05302-02	fiberglas-light-guide for 05301-03/04/ 05 and 06	1x1
05301-03	operation laryng.,KLEINSASSER 170x26x15,5x13,5mm	1x1
05302-02	fiberglas-light-guide for 05301-03/04/05 and 06	1x1
05301-02	operation laryng.,KLEINSASSER 150x20,5x13x10,5mm	1x1
05302-01	fiberglas-light-guide	1x1
05300-01	Chest support compl.KLEINSASSER for adults	1x1
53295-23	Needle holder with ratchet, straight jaw 1,8x3,5mm, serrated, WL 23cm	1x1
53280-01	micro laryngeal grasp.forceps straight serrated 1,5x10mm	1x1
53280-02	micro laryngeal grasp.forceps curved to left,serr.1,5x8,5mm	1x1
53280-03	micro laryngeal grasp.forceps curved to right,serr.1,5x8,5mm	1x1
53280-04	micro laryngeal cup forceps straight, 2,5mm Ø, 22cm long	1x1
53280-05	micro laryngeal cup forceps angled to left, 2,5mm	1x1
53280-06	micro laryngeal cup forceps angled to right, 2,5mm	1x1
53280-07	micro laryngeal cup forceps angled up 2,5mm	1x1
53280-08	micro laryngeal scissors straight vertical cutting 22cm long	1x1
53280-09	micro laryngeal scissors curved to left	1x1
53280-10	micro laryngeal scissors curved to right	1x1
41291-25	BYRD, suction tube, self cleaning, 2.5m	1x1
41292-01	injection cannula, straight, LUER-LOCK, working length 23cm	1x1
53290-08	handle for micro-laryngeal instruments	1x1
	53290-01 - 53290-07	
53290-01	micro-laryngeal sickle knife curved	1x1
53290-02	micro-laryngeal separador, oval, horizontal	1x1
53290-05	micro-laryngeal hook, 90° angled, blunt	1x1
41312-26	Coagulation suction tube monopolar 2,5mm button 3,5mm Ø, 260mm working length, angled, HF-connector male	1x1
R060-050040-003	Monopolar HF-connecting cable, 3mtr. lg. 5mm PIN for ERBE / Storz HF-units 4mm socket instrument side	1x1

SET/480:	Tracheotomie Satz / Tracheotomy Set / Juego para traqueotomía	
07103-00	scalpel handle no. 3 12,5cm	1x1
49107-19	tongue depressor, BRUENINGS 19cm	1x1
19220-01	retractor (trach.) pointed 1 prong, 16cm	1x1
19220-02	retractor (trach.) pointed 2 prongs, 16cm	1x1
19280-04	retractor, VOLKMANN pointed, 21,5cm, 4 teeth	2x1
55511-21	thyroid retractor, SCHOENBORN 21cm	1x1
19312-02	retractor, LANGENBECK 21cm, 30x14mm	2x1
19314-20	retractor, KOCHER-LANGENBECK 21cm, 60x20mm	2x1
21270-14	cotton applicators, FARREL threaded, 14cm	2x1
47415-18	FREER septum elevator, 18cm double ended, sharp/blunt	1x1
33718-16	periosteal elevator, JOSEPH 16cm, 4mm	1x1
09283-15	diss.scissors,METZENBAUM-FINO curved, 15cm	1x1
09110-14	operating scissors, STANDARD pointed/blunt, straight 14,5cm	1x1
47120-50	Nasal speculum, KILLIAN 50mm	1x1
47120-75	nasal speculum, KILLIAN 75mm	1x1
41295-08	suction tube, FRAZIER/FERGUSSON 19cm, 30°, Charr. 8	1x1
41295-12	suction tube, FRAZIER/FERGUSSON 19cm, 30°, Charr. 12	1x1
11102-14	forceps dressing, 14,5cm	1x1
11120-14	forceps tissue 1x2 t. 14,5 cm	2x1
11188-12	forceps tissue, ADSON-BROWN 7x7 teeth, 12cm	1x1
17110-20	dressing forceps, GROSS-MAIER straight, 20cm	1x1
51183-19	tonsil forceps, SCHNIDT 19cm curved	1x1
13310-16	hemost.fcps. ,ROCHESTER-PEAN straight,16cm	1x1
13310-14	hemost.fcps. ,ROCHESTER-PEAN straight, 14cm	1x1
13320-14	hemost.fcps.,ROCHESTER-OCHSNER 1x2 teeth, straight, 14cm	2x1
13221-12	hemost.fcps.,HALSTED-MOSQUITO curved, 12,0cm	4x1
15111-09	towel forceps, BACKHAUS 9cm	6x1
25164-15	needle holder, CRILE-WOOD serrated, TC, 15cm	1x1
19670-14	retractor, WEITLANER sharp, 14,0cm	1x1
47235-07	nasal cutting forceps,HARTMANN 7mm	1x1
55111-14	tracheal dilator, TROUSSEAU 14cm	1x1
55122-16	trachea hook, BOSE 16cm, left	1x1
55124-16	trachea hook, BOSE 16cm, right	1x1
55520-15	goitre seizing forceps, LAHEY 15cm	1x1
55501-15	goitre director, KOCHER 15cm, without hole	1x1
55240-08	trach.tube,CHEVALIER-JACKSON germ.silver,Fig.4, D. 8mm, 65m	1x1
55240-09	trach.tube,CHEVALIER-JACKSON germ.silver,Fig.5, D.9mm, 70mm	1x1
21110-14	grooved director, 14,5cm	1x1
55151-09	tube, WAGENER-MOSHER 9mm	1x1
91154-19	bipolar forceps, 1mm tip straight, 19,5cm long european flat connector	1x1



NUMMERNVERZEICHNIS

NUMERICAL INDEX

INDICE NUMÉRICO

HADEO
INSTRUMENTE GERMANY



03161-00	48	05217-03	324	05311-03.....	339	09282-15	115, 189
03161-01	49	05217-04	324	05311-04.....	339	09282-18	189
03161-02	50	05230-00	330	05320-01	340	09283-15	115, 189
03161-03C.....	51	05230-00CL.....	326	05320-02	340	09283-18	189
03161-03T.....	51	05230-01	330	05320-03	340	09284-12	188
03165-07	22	05230-01CL.....	326	05320-04	340	09284-15	115, 188
03167-03	22	05230-02	330	05321-01	340	09284-18	188
03171-00	52	05230-02CL.....	326	05321-02	340	09285-12	188, 297
03171-01	52	05230-03	330	05321-03	340	09285-15	115, 188,
03171-02	52	05230-03CL.....	326	05321-04	340	297
03180-90	23	05230-04	330	05322-01	341	09285-18	188, 297
03180-92	23	05230-04CL.....	326	05322-02	341	09285-20	297
03180-93	23	05233-18	333	05322-03	341	09285-23	297
03192-00	24	05234-28	333	05322-04	341	09285-25	297
03192-01	24	05238-02	332	05322-05	341	09285-28	297
03193-00	25	05238-03	332	05322-06	341	09285-30	297
03193-01	25	05238-12	332	05322-07	341	09286-15	115, 189
03193-20	24, 25	05238-13	332	07296-00	221	09286-18	189
03194-00	27	05239-01	333	07490-00	220	09287-15	115, 189
03194-01	27	05239-02	333	07490-01	220	09287-18	189
03195-00	26	05239-03	332	07490-02	220	09302-14	190
03195-01	26	05300-01	335	07495-31	221	09303-14	190
03195-06	26	05300-02	335	07496-31	221	09304-14	116, 190
03195-07	26	05300-03	335	07498-00	221	09305-14	116, 190
03195-08	26	05300-04	335	07499-00	221	09310-12	191
03196-00	27	05300-05	335	07499-01	221	09310-15	191
05150-21	284	05300-06	335	09110-11	117	09314-12	191
05150-27	284	05301-01	334	09110-13.....	117	09321-15	191
05151-01	284	05301-02	334	09110-14.....	117	09321-18	191
05151-02	284	05301-03	334	09111-11	117	09340-09	192
05203-00	327	05301-04	334	09111-13.....	117	09340-10	192
05204-00	327	05301-05	334	09111-14.....	117	09340-11.....	117, 192
05210-00	328	05301-06	334	09270-15	189	09341-09	192
05210-01	328	05301-07	334	09270-18	189	09341-10	192
05210-02	328	05302-01	334, 337,	09271-15	189	09341-11.....	117, 192
05210-03	328	341	09271-18	189	09342-08	192
05210-04	328	05302-02	334, 337,	09274-15	189	09343-08	192
05211-00	323	341	09274-18	189	09344-11.....	117, 192
05211-01.....	323	05302-03	334, 337,	09275-15	189	09345-11.....	117, 192
05211-02.....	323	341	09275-18	189	09346-11.....	192
05211-03.....	323	05303-01	337	09280-12	188	09348-01	193
05211-04.....	323	05303-10	338, 341	09280-15	115, 188	09348-02	193
05212-03	322	05304-01	338	09280-18	188	09348-03	193
05212-04	322	05304-02	338	09281-12	188, 297	09348-04	193
05213-03	329	05305-01	336	09281-15	115, 188,	09348-05	193
05213-03CL.....	325	05305-02	336	297	09348-06	193
05213-04	329	05310-01	339	09281-18	188, 297	09349-12	194
05213-04CL.....	325	05310-02	339	09281-20	297	09350-09	195
05215-02	331	05310-03	339	09281-23	297	09350-10	194
05215-03	331	05310-04	339	09281-25	297	09351-09	195
05215-04	331	05311-01	339	09281-28	297	09352-09	195
05217-02	324	05311-02.....	339	09281-30	297	09352-10	194

Nummernverzeichnis
Numerical Index
Índice numérico

HADEO
INSTRUMENTE GERMANY

09353-09	195	09981-11.....	192	10206-11.....	202	11260-15.....	95
09354-10	195	09982-12	197	10206-11SC.....	202	11270-12.....	95
09355-10	195	09983-12	197	10207-11.....	202	11270-15.....	95
09356-10	195	09984-11.....	196	10207-11SC.....	202	11272-15.....	151
09357-10	195	09985-11.....	196	10220-00	204	11273-15.....	151
09358-11.....	194	09993-15	191	10220-00T	204	11401-01.....	96
09360-11.....	196	09995-12	191	10220-25	204	11403-03.....	96
09361-11.....	196	10010-19	200	10220-25T	204	11403-04.....	96
09362-11.....	196	10011-19.....	200	10220-45	204	11404-04.....	96
09363-11.....	196	10012-19	200	10220-45T	204	11405-05.....	96
09364-10	298	10013-19	200	10220-60	204	11407-07.....	96
09370-11.....	116, 196	10014-19	200	10220-60T	204	13551-18	283
09371-11.....	116, 196	10015-19	200	10220-90	204	17131-21	295
09374-11.....	116, 196	10028-14	201	10220-90T	204	17133-17	295
09375-11.....	116, 196	10029-14	201	10226-11.....	205	17210-13	155
09401-18	198	10030-18	201	10226-14	205	17210-16	155
09403-15	198	10031-18	201	10226-18	205	17210-18	155
09405-16	198	10032-23	201	10226-18T	205	19122-13	263
09405-16TC.....	198	10033-23	201	10227-11.....	205	19210-12	246
09406-10	198	10034-14	201	10227-14	205	19211-12.....	246
09407-10	198	10035-14	201	10227-18	205	19212-01	246
09425-17	296	10036-18	201	10227-18T	205	19212-02	246
09427-17	296	10037-18	201	10228-11.....	205	19213-12	246
09435-18	296	10038-23	201	10228-14	205	19214-13	246
09437-19	296	10039-23	201	10228-18	205	19214-18	246
09439-17	296	10044-14	201	10228-18T	205	19215-01	246
09540-16	191	10045-14	201	10229-11.....	205	19215-02	246
09541-16	191	10048-14	201	10229-14	205	19215-03	246
09542-16	191	10049-14	201	10229-18	205	19215-13	246
09543-16	191	10050-12	116	10229-18T	205	19215-18	246
09544-16	191	10050-14	201	10230-11.....	205	19216-01	247
09545-16	191	10050-18	201	10230-14	205	19216-02	247
09617-13	198	10051-14	201	10230-18	205	19216-05	247
09802-09	199	10051-18	201	10230-18T	205	19216-07	247
09802-11.....	199	10061-19	200	11112-18	294	19216-10	247
09804-14	199	10061-19SC	200	11112-21	294	19217-03	247
09805-09	199	10061-19TC.....	200	11112-25	294	19217-05	247
09823-12	197	10061-23	200	11116-18	294	19217-07	247
09824-12	197	10061-23SC	200	11116-21	294	19218-01	248
09825-12	197	10061-23TC.....	200	11116-25	294	19218-02	248
09826-12	197	10201-11.....	202	11120-11.....	95	19218-11.....	248
09828-12	197	10201-11SC.....	202	11126-18.....	294	19220-01	249
09829-12	197	10202-11.....	203	11126-21	294	19220-02	249
09831-12	118, 299	10202-14	119, 203	11126-25	294	19220-03	249
09835-12	118, 299	10202-14T	203	11170-12.....	97	19220-04	249
09966-11.....	188	10202-18	203	11170-15.....	97	19221-01	249
09967-11.....	188	10202-18T	203	11180-12.....	97	19221-02	249
09970-14	188	10203-11.....	203	11180-15.....	97	19221-03	249
09970-18	188	10203-14	119, 203	11190-10.....	95, 151	19221-04	249
09971-14	188	10203-14T	203	11258-15.....	151	19226-02	249
09971-18	188	10203-18	203	11259-15.....	151	19226-03	249
09980-11.....	192	10203-18T	203	11260-12.....	95	19226-04	249

19227-02	249	21290-12	64	25673-18T	124	33470-06	104
19227-03	249	21290-14	64	25674-14	124	33474-96	103
19227-04	249	21290-16	64	25674-18	124	33474-97	103
19283-01	114	21292-12	64	25675-14	124	33474-98	103
19283-02	114	21292-14	64	25675-18	124	33475-00	103
19283-03	114	21292-16	64	25676-14	124	33475-01	103
19314-07	263	21310-15	64	25677-14	124	33475-02	103
19314-14	263	21320-12	64	25691-18	124	33475-03	103
19314-20	263	21320-18	64	25700-18	123	33475-04	103
19344-14	263	21350-25	347	25701-18	123	33475-05	103
19344-20	263	21360-26	347	25720-12	123	33475-06	103
19344-26	263	21370-25	347	25720-12D	123	33476-01	104, 258
19499-00	263	23128-19	215	25720-13	123	33476-02	104, 258
19610-07	110	23140-02	215	25720-13D	123	33476-03	104, 258
19611-07	110	23181-40	215	25720-14	123	33485-99	105
19620-07	110	25110-12	209	25720-14D	123	33486-00	105
19620-10	110	25114-12	209	25730-18	123	33486-01	105
19621-07	110	25128-13	209	25730-18D	123	33486-02	105
19621-10	110	25129-13	209	25731-12	123	33486-99	105
19630-10	110	25130-13	209	25731-13	123	33487-00	105
19631-10	110	25134-13	209	25731-14	123	33487-01	105
19634-10	110	25136-11	209	25731-18	123	33487-02	105
19635-10	110	25137-11	209	25731-18D	123	33487-99	258
19650-10	111	25140-13	209	33115-15	106	33488-00	258
19651-10	111	25144-13	209	33117-15	106	33488-01	258
19654-13	111	25160-15	209	33119-15	106	33488-02	258
19655-13	111	25164-15	209	33131-15	106	33490-10	103
19670-14	111	25660-12	123	33133-15	106	33490-20	103
19670-16	111	25660-13	123	33148-18	106	33490-30	103
19671-14	111	25660-14	123	33150-16	107	33490-40	103
19671-16	111	25661-12	123	33151-16	107	33490-50	103
19672-11	113, 264	25661-13	123	33156-18	107	33495-16	103
19673-11	113, 264	25661-14	123	33157-02	107	33496-00	105
19674-15	112	25668-18	124	33157-03	107	33496-01	105
19675-13	113	25670-14	124	33201-18	107	33496-12	105
19677-10	113, 264	25670-18	124	33205-18	107	33498-00	105
19677-13	113, 264	25671-12D	123	33211-15	107	33498-01	105
19683-17	112	25671-13D	123	33213-15	107	33498-12	105
19684-14	112	25671-14	124	33280-15	108	33600-02	98
19685-14	112	25671-14D	123	33281-15	108	33600-03	98
19690-17	265	25671-18	124	33282-19	108, 208	33600-04	98
19691-17	265	25672-14	124	33283-17	108, 208	33600-05	98
21115-10	63	25672-14D	124	33393-18	104	33602-04	98
21270-12	63	25672-14T	124	33469-96	104	33602-06	98
21270-14	63	25672-18	124	33469-97	104	33602-08	98
21270-16	63	25672-18D	124	33469-98	104	33602-10	98
21272-12	63	25672-18T	124	33470-00	104	33602-12	98
21272-14	63	25673-14	124	33470-01	104	33602-14	98
21272-16	63	25673-14D	124	33470-02	104	33602-16	98
21277-12	63	25673-14T	124	33470-03	104	33604-04	98
21277-14	63	25673-18	124	33470-04	104	33604-06	98
21277-16	63	25673-18D	124	33470-05	104	33604-08	98

33604-10	98	33665-12	100	41295-15	125, 213	41511-01	181
33604-12	98	33686-25	259	41297-06	213	41511-02	181
33604-14	98	33693-32	102, 259	41297-07	213	41511-03	181
33604-16	98	33694-01	102, 259	41297-08	213	41511-04	181
33605-04	98	33694-02	259	41297-09	213	41511-05	181
33605-06	98	33694-03	102, 259	41297-10	213	41512-01	181
33605-08	98	33695-40	260	41297-11	213	41512-02	181
33605-10	98	33696-75	260	41297-12	213	41512-03	181
33605-12	98	33698-98	102, 260	41299-03	128	41512-04	181
33605-14	98	33700-05	102, 260	41299-05	128	41512-05	181
33605-16	98	33700-08	102	41299-07	128	41803-01	57
33620-02	99	33701-16	91	41300-00	129	41807-00	57
33620-03	99	33702-15	90	41300-02	126	41810-10	57
33620-04	99	33703-15	90	41300-03	126	41821-21	57, 148
33620-05	99	33707-17	86	41300-04	126	41842-44	148
33620-06	99	33708-19	86	41300-05	126	41843-50	148
33623-02	99	33710-19	86	41302-02	125	41850-41	148
33623-03	99	33711-16	87	41303-09	126, 214	43376-13	250
33623-04	99	33712-16	87	41303-12	126, 214	43377-13	250
33623-05	99	33713-16	87	41303-15	126, 214	43602-01	261
33623-06	99	33713-17	87	41303-18	126, 214	43602-02	261
33626-25	98, 235	33714-15	86	41303-25	126, 214	43602-03	261
33626-35	98, 235	33716-18	92	41303-30	126, 214	43613-00	262, 293
33628-03	98	33718-16	88	41303-45	126, 214	43614-00	262, 293
33628-05	98	33720-19	226	41304-06	126	43614-01	262, 293
33652-02	99, 229	33720-20	226	41304-08	126	43614-12	262, 293
33652-03	99, 229	33722-06	90, 227	41304-10	126	43614-23	262, 293
33652-04	99, 229	33722-08	90, 227	41305-05	129	43614-34	262, 293
33652-06	99, 229	33724-02	92	41305-06	129	43614-45	262, 293
33652-08	99, 229	33724-03	92	41305-07	129	43614-56	262, 293
33652-10	99, 229	33724-04	92	41305-08	129	43614-67	262, 293
33652-12	99, 229	33740-19	89	41305-09	129	43614-78	262, 293
33652-15	99, 229	33741-18	89	41305-10	129	44650-01	131
33654-02	99, 229	33742-18	89	41305-12	129	44650-02	131
33654-03	99, 229	33743-18	89	41305-15	129	44651-01	131
33654-04	99, 229	33761-21	290	41305-18	129	44651-02	131
33654-06	99, 229	34520-02	302	41305-20	129	44652-01	131
33654-08	99, 229	34520-03	302	41305-25	129	44652-02	131
33654-10	99, 229	34520-04	302	41305-30	129	45009-02	53
33654-12	99, 229	41291-20	348	41306-00	127	45009-03	53
33654-15	99, 229	41291-25	348	41306-05	125, 127	45009-04	53
33660-15	228	41291-30	348	41306-07	125, 127	45010-00	53
33660-20	228	41292-01	349	41306-09	125, 127	45010-20	53
33664-04	100	41292-02	349	41307-00	129	45010-30	53
33664-06	100	41294-40	213	41308-00	127	45010-45	53
33664-08	100	41295-06	125, 213	41312-10	211, 348	45010-55	53
33664-10	100	41295-07	125, 213	41312-26	211, 348	45010-65	53
33664-12	100	41295-08	125, 213	41510-01	181	45010-75	53
33665-04	100	41295-09	125, 213	41510-02	181	45011-00	53
33665-06	100	41295-10	125, 213	41510-03	181	45011-03	53
33665-08	100	41295-11	125, 213	41510-04	181	45011-04	53
33665-10	100	41295-12	125, 213	41510-05	181	45011-05	53

45011-07.....	53	45060-03.....	58	45111-00.....	68	45193-03.....	66, 250
45011-08.....	53	45060-04.....	58	45112-00.....	68	45194-01.....	67
45012-00.....	53	45060-05.....	58	45112-01.....	68	45194-02.....	67
45012-40.....	53	45061-00.....	58	45112-02.....	68	45194-03.....	67
45012-55.....	53	45070-01.....	58	45112-03.....	69	45194-04.....	67
45012-65.....	53	45070-02.....	58	45112-04.....	69	45195-00.....	67
45012-75.....	53	45070-03.....	58	45112-05.....	69	45195-01.....	67
45014-00.....	53	45070-04.....	58	45114-00.....	68	45195-02.....	67
45014-45.....	53	45070-05.....	58	45115-00.....	68	45195-15.....	66
45014-55.....	53	45070-06.....	58	45115-01.....	68	45201-11.....	94, 152
45014-65.....	53	45071-00.....	58	45115-02.....	68	45201-13.....	94, 152
45014-75.....	53	45072-01.....	59	45115-03.....	69	45203-11.....	94, 152
45015-00.....	53	45073-01.....	59	45115-04.....	69	45206-14.....	94, 152
45015-45.....	53	45073-02.....	59	45115-05.....	69	45206-16.....	94, 152
45015-55.....	53	45073-03.....	59	45116-00.....	68	45207-16.....	94, 152
45015-65.....	53	45073-04.....	59	45117-00.....	68	45208-14.....	94, 152
45018-00.....	53	45073-05.....	59	45117-01.....	68	45209-12.....	97
45018-50.....	53	45073-06.....	59	45117-02.....	68	45220-16.....	72
45018-60.....	53	45074-01.....	59	45117-03.....	69	45222-17.....	72
45018-70.....	53	45075-00.....	59	45117-04.....	69	45225-02.....	72
45018-80.....	53	45076-01.....	59	45117-05.....	69	45243-14.....	74, 155
45019-30.....	54	45080-00.....	60	45133-01.....	70	45245-12.....	74
45019-40.....	54	45090-00.....	60	45133-02.....	70	45246-12.....	74
45019-45.....	54	45090-02.....	60	45133-03.....	70	45246-14.....	74
45019-50.....	54	45090-03.....	60	45133-04.....	70	45251-10.....	73
45019-55.....	54	45090-04.....	60	45133-05.....	70	45253-11.....	73
45019-60.....	54	45090-05.....	60	45150-18.....	70	45255-08.....	75
45019-65.....	54	45090-06.....	60	45151-16.....	70	45257-08.....	75, 175
45019-70.....	54	45090-08.....	60	45152-01.....	70	45261-08.....	75
45019-75.....	54	45091-00.....	61	45152-02.....	70	45261-14.....	75
45020-30.....	54	45091-01.....	61	45153-16.....	71	45261-16.....	75
45020-40.....	54	45091-02.....	61	45160-15.....	71	45263-08.....	75
45020-45.....	54	45091-03.....	61	45162-18.....	71	45263-14.....	75
45020-50.....	54	45091-04.....	61	45164-17.....	71	45265-08.....	75
45020-55.....	54	45091-15.....	61	45165-17.....	71	45267-20.....	75, 175
45020-60.....	54	45091-17.....	61	45171-12.....	65	45267-25.....	75, 175
45020-65.....	54	45091-22.....	61	45173-12.....	65	45267-30.....	75
45020-70.....	54	45096-00.....	62	45180-01.....	65	45269-30.....	75
45020-75.....	54	45096-50.....	61	45180-02.....	65	45271-08.....	75
45030-04.....	55	45096-75.....	61	45180-03.....	65	45273-08.....	75
45030-06.....	55	45097-01.....	61	45181-13.....	65	45274-08.....	75
45030-07.....	55	45097-02.....	61	45184-16.....	65	45275-08.....	75, 175
45030-08.....	55	45097-03.....	61	45185-15.....	65	45276-08.....	75
45030-10.....	55	45097-10.....	61	45190-01.....	66	45300-30.....	80
45036-03.....	56	45097-15.....	61	45190-02.....	66	45310-40.....	80
45036-06.....	56	45109-00.....	68	45192-01.....	66	45312-55.....	80
45036-07.....	56	45110-00.....	68	45192-02.....	66	45313-55.....	80
45036-08.....	56	45110-01.....	68	45192-03.....	66	45315-55.....	80
45036-09.....	55	45110-02.....	68	45192-04.....	66	45317-55.....	80
45036-10.....	55	45110-03.....	69	45192-05.....	66	45320-70.....	80
45060-01.....	58	45110-04.....	69	45193-01.....	66, 250	45321-70.....	80
45060-02.....	58	45110-05.....	69	45193-02.....	66, 250	45322-70.....	80

45324-03	82	45704-15	122	45737-15	136	47050-07	140
45325-03	82	45705-15	122	45741-03	136	47060-01	140
45350-40	76	45706-35	122	45741-06	136	47060-02	140
45350-70	76	45708-16	121	45741-10	136	47060-03	140
45352-40	76	45709-10	120	45743-03	136	47102-01	141
45353-60	76	45709-14	120	45743-06	136	47102-02	141
45355-60	76	45709-16	120	45743-10	136	47102-03	141
45357-40	76	45709-20	120	45745-03	136	47103-01	142
45359-40	76	45709-26	120	45745-06	136	47103-02	142
45360-35	76	45709-28	120	45745-10	136	47103-03	142
45361-01	77	45709-30	120	45746-20	137	47112-01	143
45361-02	77	45710-14	120	45747-03	136	47112-02	143
45361-03	77	45710-15	135	45747-06	136	47112-03	143
45361-04	77	45710-20	120	45747-10	136	47113-03	143
45361-05	77	45710-25	120	45748-16	137	47116-13	144
45362-45	77	45711-15	135	45749-16	137	47116-14	144
45363-45	77	45713-15	135	45750-16	137	47118-13	144
45365-45	77	45715-17	135	45751-16	93	47120-35	144
45367-50	77	45720-03	135	45753-16	93	47120-35S	145
45369-50	77	45720-06	135	45755-16	93	47120-50	144
45370-50	81	45720-10	135	45756-10	138	47120-50S	145
45371-40	81	45722-03	135	45756-20	138	47120-75	144
45372-60	81	45722-04	135	45756-30	138	47120-75S	145
45385-01	84	45722-06	135	45756-40	138	47120-90	144
45385-02	84	45722-08	135	45756-50	138	47120-90S	145
45387-01	84	45722-10	135	45757-16	93	47124-35	146
45387-02	84	45722-12	135	45758-01	93	47124-35S	147
45390-35	78	45722-15	135	45758-02	93	47124-50	146
45390-50	78	45722-20	135	45758-03	93	47124-50S	147
45391-35	78	45722-25	135	45760-01	133	47124-75	146
45392-35	78	45724-03	135	45760-02	133	47124-75S	147
45393-50	78	45724-04	135	45762-01	133	47124-90	146
45394-50	78	45724-06	135	45762-02	133	47124-90S	147
45400-01	79	45724-08	135	45766-35	132	47139-12	345
45400-02	79	45724-10	135	45766-40	132	47139-14	345
45400-03	79	45724-12	135	45766-45	132	47139-16	345
45401-25	79	45724-15	135	45766-50	132	47139-18	345
45402-10	79	45724-20	135	45770-01	134	47151-15	149
45403-13	79	45724-25	135	45770-16	137	47151-18	149
45404-13	79	45725-05	135	45771-16	137	47154-20	150
45410-01	83	45725-10	135	45802-16	88	47155-20	150
45411-01	83	45730-03	136	45803-16	88	47158-20	154
45412-01	83	45730-06	136	45805-16	88	47159-20	154
45413-01	83	45730-10	136	45806-16	88	47161-16	154
45414-01	83	45732-03	136	45806-17	92	47161-20	154
45430-00	85	45732-06	136	45807-20	91	47167-18	156
45440-19	85	45732-10	136	47050-01	140	47169-18	156
45701-01	122	45733-05	136	47050-02	140	47171-14	155
45701-02	122	45733-10	136	47050-03	140	47173-14	155
45702-01	121	45735-05	136	47050-04	140	47181-18	157
45702-02	121	45735-10	136	47050-05	140	47185-18	157
45703-15	122	45736-15	136	47050-06	140	47191-01	158

47191-02	158	47231-01	171	47317-00	184	47332-30	212
47191-03	158	47231-02	171	47317-11	178	47332-40	212
47191-04	158	47232-00	172	47317-70	178	47342-25	261
47192-18	158	47233-00	173	47317-90	178	47342-30	261
47193-01	158	47233-01	173	47318-00	184	47342-40	261
47193-02	158	47233-02	174	47318-11	178	47345-15	212
47195-01	157	47233-03	174	47318-70	178	47347-20	227
47195-02	157	47235-05	169	47318-90	178	47350-26	162
47197-01	157	47235-07	169	47319-00	15	47351-26	162
47197-02	157	47235-09	169	47319-35	186	47352-24	163
47223-00	164	47235-11	169	47319-45	186	47355-03	163
47223-01	164	47235-13	307	47320-00	167	47370-16	216
47223-02	164	47235-15	307	47320-11	178	47371-16	216
47223-03	164	47239-01	169	47320-35	186	47372-16	216
47223-04	164	47239-02	169	47320-45	186	47372-17	219
47223-05	164	47241-00	165	47320-70	178	47373-16	216
47223-30	180	47242-00	165	47320-90	178	47374-16	216
47223-35	180	47242-01	165	47321-00	185	47375-16	216
47223-40	180	47243-00	310	47321-11	176	47375-19	216
47224-00	164	47244-00	311	47321-70	178	47376-16	217
47224-01	164	47245-01	311	47321-90	178	47377-13	219
47224-02	164	47245-02	311	47322-00	185	47379-16	217
47224-03	164	47246-18	310	47322-11	178	47380-15	217
47224-04	164	47251-21	161	47322-70	178	47382-15	217
47224-05	164	47255-01	166	47322-90	178	47384-15	217
47224-30	180	47255-02	166	47323-00	185	47385-15	217
47224-35	180	47256-20	206	47323-10	178	47386-01	217
47224-40	180	47303-03	109, 182	47323-19	159	47386-02	217
47225-01	164	47303-04	109, 182	47323-80	178	47387-01	256
47225-02	164	47303-05	109, 182	47324-00	185	47387-02	256
47225-03	164	47303-06	109, 182	47324-01	176	47388-01	257
47225-04	164	47304-01	182	47324-02	176	47388-02	257
47226-01	168	47304-02	182	47324-03	177	47388-03	257
47226-02	168	47304-03	182	47324-04	177	47388-04	257
47226-03	168	47304-04	182	47324-05	177	47388-05	257
47226-30	180	47305-01	187	47325-00	185	47390-03	218
47226-35	180	47305-02	187	47325-01	179	47390-04	218
47226-40	180	47305-03	187	47325-02	179	47390-05	218
47227-01	168	47310-00	184	47325-03	179	47392-03	218
47227-02	168	47311-00	184	47325-19	159	47392-04	218
47227-03	168	47311-10	109	47326-01	179	47392-05	218
47227-30	180	47311-25	109	47326-02	179	47399-01	257
47227-35	180	47311-30	109	47326-03	179	47399-02	257
47227-40	180	47312-00	184	47327-01	179	47410-04	92, 222
47230-00	170	47313-00	184	47327-02	179	47410-05	92, 222
47230-01	170	47314-00	184	47327-03	179	47410-16	222
47230-02	170	47315-00	184	47331-20	212	47411-16	222
47230-03	170	47316-00	184	47331-25	212	47412-20	226
47230-04	170	47316-11	178	47331-30	212	47413-19	222
47230-05	170	47316-16	183	47331-40	212	47414-21	222
47230-06	170	47316-70	178	47332-20	212	47415-18	91, 223
47231-00	171	47316-90	178	47332-25	212	47417-19	223

Nummernverzeichnis
Numerical Index
Indice numérico

HADEO
INSTRUMENTE GERMANY

47419-19	223	47472-16	232	47541-14	251	47642-01	309
47420-01	223	47473-01	233	47542-12	251	47642-02	309
47420-02	223	47473-02	233	47551-16	251	47642-03	309
47420-03	223, 261	47473-03	233	47551-16CL	251	49102-16	268
47420-04	224	47474-01	233	47552-16	251	49104-15	268
47420-20	224	47474-02	233	47553-15	252	49105-16	268
47421-21	224	47474-03	233	47554-01	253	49106-01	268
47421-23	224	47475-04	234	47554-02	253	49107-19	268
47422-22	224	47475-06	234	47554-03	253	49108-15	268
47423-22	224	47475-08	234	47555-08	253	49109-19	268
47424-16	225	47482-05	236	47556-16	253	49110-19	269
47425-19	225	47484-04	236	47557-17	253	49111-15	269
47426-22	225	47484-06	236	47558-15	254	49115-01	269
47427-21	261	47484-08	236	47559-20	252	49115-02	269
47428-21	225	47486-16	236	47560-18	254	49117-11	269
47430-22	225	47487-16	236	47562-18	254	49119-14	270
47450-04	100, 230	47489-16	236	47563-22	255	49230-11	270
47451-04	100, 230	47502-16	238	47564-16	254	49231-12	270
47454-04	100, 231	47504-18	238	47565-10	153	49231-14	270
47454-07	100, 231	47507-17	238	47566-12	252	49231-16	270
47454-09	100, 231	47507-18	238	47568-08	255	49235-19	270
47454-12	100, 231	47511-21	239	47569-14	250	49250-16	270
47455-06	231	47513-21	239	47571-23	160	49250-18	270
47457-03	235	47514-16	239	47572-23	160	49255-16	270
47457-05	235	47516-16	239	47573-23	160	49265-12	271
47458-04	231	47518-21	239	47575-23	160	49265-14	271
47458-07	231	47520-21	240	47601-21	256	49267-12	271
47458-09	231	47522-01	241	47607-01	256	49270-16	271
47458-12	231	47522-04	241	47607-02	256	49270-19	271
47460-04	231	47522-05	241	47607-03	256	49272-13	271
47460-07	231	47522-07	241	47607-04	256	49274-09	271
47460-12	231	47522-09	241	47607-05	256	49274-11	271
47461-00	237	47523-01	238	47607-06	256	49274-13	271
47463-10	234	47523-02	238	47620-00	308	49274-15	271
47463-12	234	47524-01	238	47620-01	308	49287-02	272
47463-14	234	47525-20	238	47620-02	308	49287-03	272
47470-04	232	47526-16	243	47620-03	308	49287-04	272
47470-05	232	47526-20	238	47620-04	308	49287-05	272
47470-06	232	47527-16	243	47620-05	308	49288-02	272
47470-07	232	47528-01	242	47620-06	308	49288-03	272
47471-02	101, 232	47528-02	242	47630-00	308	49288-04	272
47471-03	101, 232	47529-16	243	47630-01	308	49288-05	272
47471-04	101, 232	47530-00	130, 244	47630-02	308	49310-00	273
47471-05	101, 232	47530-01	130, 244	47630-03	308	49310-01	273
47471-06	101, 232	47530-02	130, 244	47630-04	308	49310-02	273
47471-07	101, 232	47532-19	244	47636-01	309	49310-03	273
47471-08	101, 232	47533-19	244	47636-02	309	49310-04	273
47471-10	101, 232	47534-19	244	47636-03	309	49310-05	273
47471-12	101, 232	47535-01	245	47636-04	309	49310-09	274
47472-10	232	47535-02	245	47641-01	309	49310-10	274
47472-12	232	47535-20	245	47641-02	309	49310-11	274
47472-14	232	47540-16	251	47641-03	309	49310-12	274

49315-00	275	50237-35	31	51185-19.....	281	53131-20	354
49315-01	275	50237-40	31	51187-19.....	281	53132-20	354
49315-02	275	50237-45	31	51191-19.....	281	53132-30	354
49315-03	275	50237-50	31	51193-19.....	281	53132-40	354
49315-10	275	50237-60	31	51202-19	281	53132-50	354
49317-00	276	50237-70	31	51203-19	281	53132-60	354
49317-01	276	50238-35	31	51205-18	281	53150-00	354
49317-02	276	50238-40	31	51205-23	281	53152-00	354
49317-03	276	50238-45	31	51207-21	281	53154-00	354
49317-10	276	50238-50	31	51209-20	281	53155-00	354
49320-00	277	50242-07	30	51210-20	282	53157-00	354
49320-01	277	50242-08	30	51211-21	282	53158-02	354
49320-02	277	50242-10	30	51213-21	282	53158-03	354
49320-03	277	50242-15	30	51214-20	283	53160-02	354
49320-10	277	50242-18	30	51215-20	283	53160-03	354
49320-20	277	50242-20	30	51219-22	282	53162-00	354
49340-00	277	50242-23	30	51250-28	301	53164-01	354
49341-00	277	50242-25	30	51252-28	301	53164-02	354
49342-01	278	50242-27	30	51256-28	301	53166-00	354
49342-02	278	50242-30	30	51257-40	302	53170-00	354
49342-03	278	50242-35	30	51257-50	302	53175-00	354
49342-04	278	50242-40	30	51259-03	302	53177-01	354
49342-05	278	50242-45	30	51259-04	302, 319	53177-02	354
49345-01	279	50242-50	30	51259-05	302	53230-01	356
49345-02	279	50242-60	30	51260-00	300	53230-02	356
49345-03	279	50242-70	30	51265-00	303	53230-03	356
49345-04	279	51103-18	288	51270-00	305	53230-04	356
49345-05	279	51103-20	288	51290-02	210, 306	53230-05	356
49360-10	280	51103-22	288	51290-05	210, 306	53230-06	356
49400-01	280	51104-18	288	51290-10	210, 306	53230-07	356
50236-06	30	51109-24	289	51290-20	210, 306	53230-08	356
50236-08	30	51111-23	289	51291-00	210, 306,	53240-01	356
50236-10	30	51131-22	290	344	53240-02	356
50236-14	30	51133-23	290	51292-00	210, 306,	53240-03	356
50236-18	30	51134-21	290	344	53240-04	356
50236-23	30	51135-01	290	51293-00	210, 306,	53240-05	356
50236-31	30	51135-02	290	344	53240-06	356
50236-35	30	51139-25	291	51293-45	210, 306,	53240-07	356
50236-40	30	51143-24	291	344	53240-08	356
50236-45	30	51151-19	292	51293-90	210, 306,	53250-01	356
50236-50	30	51165-22	285	344	53250-02	356
50236-60	30	51167-22	285	53101-22	343	53250-03	356
50236-70	30	51168-23	285	53102-20	343	53250-04	356
50237-06	31	51170-24	286	53103-22	343	53250-05	356
50237-08	31	51171-22	286	53111-18	342	53250-06	356
50237-10	31	51172-19	287	53115-01	342	53250-07	356
50237-14	31	51173-21	287	53115-02	342	53250-08	356
50237-18	31	51174-21	287	53115-03	342	53260-01	356
50237-23	31	51176-20	304	53115-04	342	53260-02	356
50237-25	31	51177-23	287	53121-24	343	53260-03	356
50237-27	31	51181-19	281	53122-00	319	53260-04	356
50237-30	31	51183-19	281	53130-00	354	53260-05	356

Nummernverzeichnis
Numerical Index
Indice numérico

HADEO
INSTRUMENTE GERMANY

53260-06	356	53290-05	352	91010-02	34	91127-16.....	36
53260-07	356	53290-06	352	91010-03	34	91142-16.....	37
53260-08	356	53290-07	352	91010-11.....	34	91144-16.....	37
53270-08	346	53290-08	353	91010-12	34	91146-16.....	37
53270-10	346	53290-11.....	353	91010-13	34	91152-19.....	37
53270-12	346	53290-12	353	91010-14	34	91154-19.....	37
53270-14	346	53290-13	353	91010-15	34	91157-19.....	37
53270-16	346	53290-14	353	91010-16	34	91159-19.....	37
53270-18	346	53290-15	353	91010-17	34	91160-03N	40
53270-20	346	53290-16	353	91010-18	34	91160-05N	40
53270-22	346	53295-23	349	91010-21	34	91160-10N	40
53270-24	346	55111-13.....	314	91010-31	34	91160-20N	40
53270-26	346	55111-14.....	314	91010-33	34	91162-05N	40
53270-28	346	55113-14.....	314	91010-34	34	91162-10N	40
53270-30	346	55115-07.....	314	91010-35	34	91162-19.....	38
53272-08	346	55116-15.....	314	91010-36	34	91164-19.....	38
53272-10	346	55117-17.....	314	91011-51.....	35	91166-03N	41
53272-12	346	55118-16.....	315	91011-52.....	35	91166-05N	41
53272-14	346	55119-16.....	315	91011-53.....	35	91166-10N	41
53272-16	346	55120-15	315	91011-54.....	35	91166-19.....	38
53272-18	346	55122-16	315	91011-55.....	35	91166-20N	41
53272-20	346	55124-16	315	91011-56.....	35	91167-19.....	38
53272-22	346	55151-05	315	91011-61.....	35	91168-05N	41
53272-24	346	55151-07	315	91011-62.....	35	91168-10N	41
53272-26	346	55151-09	315	91020-01	35	91169-19.....	38
53272-28	346	55220-04	316	91020-02	35	91172-03.....	38
53272-30	346	55220-05	316	91020-03	35	91172-07.....	38
53274-12	346	55220-06	316	91020-04	35	91172-12.....	38
53276-10	346	55220-07	316	91022-05	35	91176-19.....	44
53280-01	350	55220-08	316	91022-10	35	91177-20.....	44
53280-02	350	55220-09	316	91022-20	35	91178-14.....	45
53280-03	350	55220-10	316	91024-10	35	91179-18N	43
53280-04	351	55220-11	316	91024-15	35	91180-05N	40
53280-05	351	55220-12	316	91024-20	35	91180-10N	40
53280-06	351	55220-13	316	91030-02	35	91180-20N	40
53280-07	351	55240-04	316	91030-04	35	91182-10N	40
53280-08	351	55240-05	316	91030-06	35	91182-20N	40
53280-09	351	55240-06	316	91102-11	36	91200-05N	40
53280-10	351	55240-07	316	91104-11	36	91200-10N	40
53280-11	351	55240-08	316	91109-11	36	91200-20N	40
53280-12	351	55240-09	316	91110-03N	40	91201-20S	42
53280-16	350	55240-10	316	91110-05N	40	91202-05N	40
53280-17	350	55240-11	316	91110-10N	40	91202-10N	40
53280-18	350	55240-12	316	91112-03N	40	91202-20N	40
53280-19	351	55240-13	316	91112-05N	40	91206-05N	41
53280-20	351	55501-15	317	91112-10N	40	91206-10N	41
53280-21	351	55503-15	317	91113-11	36	91206-20N	41
53280-22	351	55511-21.....	317	91115-11	36	91207-10N	41
53290-01	352	55520-15	318	91122-16.....	36	91208-10N	41
53290-02	352	55520-20	318	91123-16.....	36	91220-10N	40
53290-03	352	55523-17	318	91124-16.....	36	91220-20N	40
53290-04	352	91010-01	34	91125-16.....	36	91222-10N	40

91222-20N.....	40	R400-027175-070...15
91226-05N.....	41	R400-040175-000...15
91226-10N.....	41	R400-040175-030...15
91226-20N.....	41	R400-040175-045...15
91227-10N.....	41	R400-040175-070...15
91228-10N.....	41	R501-027041-000...17
91240-10N.....	40	R501-027041-030...17
91242-10N.....	40	R501-040050-000...17
91246-05N.....	41	R501-040050-030...17
91246-10N.....	41	R503-100148-070...17
91246-20N.....	41	R503-100173-070...17
91300-10N.....	40	R503-110145-090...17
91300-20N.....	40	R503-110173-090...17
93250-15T.....	123	R805-130402-034...14
93250-18T.....	123	R900-000000-01.....20
93251-15T.....	123	R900-000000-02.....20
93251-18T.....	123	R900-000000-03.....20
93260-15T.....	123	R900-000000-04.....20
93260-18T.....	123	R900-000000-05.....20
93261-15T.....	123	R900-000000-06.....20
93261-18T.....	123	R900-000000-07.....20
93755-14.....	207	R900-000000-09.....20
93756-14.....	207	R900-000000-11.....20
93757-14.....	207	R900-000000-13.....20
R010-030302-000...18		R900-000000-15.....20
R010-030302-030...18		R900-000000-21.....20
R010-050240-000...18		R900-000000-31.....20
R010-050240-030...18		R900-035180-00.....19
R010-050240-070...18		R900-035230-00.....19
R010-055490-000...18		R900-035300-00.....19
R010-055490-030...18		R900-035350-00.....19
R065-020080-003...39		R900-048180-00.....19
R065-020080-005...39		R900-048230-00.....19
R065-020080-103...39		R900-048250-00.....19
R065-020080-105...39		R900-048300-00.....19
R065-040000-003...39		R900-048350-00.....19
R065-040000-005...39		R901-035180-00.....19
R065-040000-103...39		R901-035230-00.....19
R065-040000-105...39		R901-035300-00.....19
R065-040125-003...39		R901-035350-00.....19
R065-040125-005...39		R901-048180-00.....19
R065-040125-103...39		R901-048230-00.....19
R065-040125-105...39		R901-048250-00.....19
R065-040285-003...39		R901-048300-00.....19
R065-040285-005...39		R901-048350-00.....19
R065-040285-103...39		
R065-040285-105...39		
R300-040302-000...16		
R300-040302-030...16		
R300-040302-070...16		
R400-027175-000...15		
R400-027175-030...15		



ALPHABETISCHER INDEX

ALPHABETICAL INDEX

INDEX ALPHABÉTICO

HADEO
INSTRUMENTE GERMANY

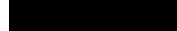

A			
ABRAHAM, Tonsillennmesser	287	AUFRICHT, Nasenhaken.....	251
ABRAHAM, Tonsillenzange	282	AUFRICHT, Nasenraspel.....	239
Absaugrohr f. Laryngoskope	338	Aufsatz, BARACANI	354
ACM-Kaltlichtkabeladapter	20	Aufsatz, BRUENINGS	354
Adapter	20	Aufsatz, CORDES	354
Adapter Winter+IBE.....	20	Aufsatz, FRAENKEL.....	354
Adapter, ACM	20	Aufsatz, KRAUSE.....	354
Adapter, Aesculap.....	20	Aufsatz, LANGE	354
Adapter, British	20	Aufsatz, SCHEINMANN	354
Adapter, Codman.....	20	Aufsatz, SCHUMACHER.....	354
Adapter, Comeg.....	20	Aufsatz, SEIFERT	354
Adapter, Dyonics	20		
Adapter, Endoskope	20	B	
Adapter, Fuji	20	BABY-METZENBAUM,	
Adapter, Heine.....	20	Supercutschere	188
Adapter, Henke-Sass-Wolf	20	BABY-WEBSTER, Nadelhalter	209
Adapter, HOUSE	129	BABY-YANKAUER, Saugrohr.....	284
Adapter, Kaltlichtkabel.....	20	Ball, KABIERSKE	60
Adapter, Lichtquellen.....	20	BALLENGER, Schwingmesser.....	218
Adapter, Medicon.....	20	BALLENGER, Septumelevatorium.....	225
Adapter, MLW	20	BALLENGER, Tonsillenzange	281
Adapter, Olympus.....	20	BALLENGER-HAJEK,	
Adapter, Pentax.....	20	Septumelevatorium.....	225
Adapter, Stirnleuchte	24, 25	BALLENGER-SLUDER,	
Adapter, Storz.....	20	Tonsillotom.....	305
Adapter, Volpi-Schölly-RFO.....	20	BANE-HARTMANN,	
Adapter, Wolf	20	Hohlmeißelzange.....	106
Adenotom, LAFORCE	309	BARACANI, Aufsatz	354
ADSON, anatomische Pinzette	97	BARANY, Lärmtrommel.....	60
ADSON, chirurgische Pinzette	97	BARBARA, Häkchen	135, 136
ADSON, Wundspreizer	112	BARBARA, Nadel.....	135
ALDERDYCE, Tonsillendissektor.....	290	BARNHILL, Ringmesser.....	308
ALM, Wundspreizer.....	110	BARON, Saugrohr.....	128
anatomische Pinzette, ADSON.....	97	BARRAQUER, Mikro Nadelhalter	123
anatomische Pinzette, McINDOE.....	151	BARSKY, Wundhäkchen	248
anatomische Pinzette,		BARTH, scharfer Löffel.....	104
POTTS-SMITH	294	Batteriegriffe	332, 333
anatomische Pinzette, SEMKEN.....	95	BECKMANN, Ringmesser	308
ANDERSON-NEIVERT, Osteotom.....	233	BELLUCCI, Mikro Ohrschere	80
ANDREW, Zungendrucker	269	BERGMANN, Wundhäkchen.....	250
Antihaftpinzetten, bipolare	40, 41	BEUSE, Face-Lift-Schere.....	201
Antrumhäkchen, PLESTER.....	137	BEYER, Hohlmeißelzange	107
Antrumküretten	256, 257	Biegegerät, SCHUHKNECHT.....	85
Antrumkürette, COAKLEY.....	256	BILLEAU, Ohrschlinge.....	65
Antrumkürette, FAULKNER.....	256	Biopsie- u. Faßzange, Optiken	15
Antrumlöffel	257	Biopsiestanze	179
Antrumraspel, WIENER.....	238	Biopsiezange	167
Antrumstanze	184, 185	bipolare Koagulationselektoden	44, 45
Antrumstanze, OSTROEM	184	bipolare Pinzetten.....	36-38, 41
Arthroskop	15	bipolare Saugpinzette.....	42
ASCH, Septumrichtzange.....	160	bipolare Stichkoagulationselektrode	44
		bipolare Verbindungskabel	39
		bipolare Pinzette, antihafte.....	40, 41
		BLAKESLEY, Nasenzange	164, 168, 180
		Blechscherer, UNIVERSAL	118, 299
		Blepharoplastikschere,	
		GREENBERG-PAR	202
		Blepharoplastikschere, KAYE.....	202
		BLOHMKE, Tonsillenzange	281
		BLUMENTHAL,	
		Hohlmeißelzange.....	106
		Blutstillungsmeißel,	
		PASSOW.....	98, 235
		BOEHLER, Hohlmeißelzange	107
		BOETTCHER, Tonsillenschere.....	296
		Bohrer, HNO.....	30, 31
		BOIES, Elevatorium.....	226
		BONN, feine Schere	192
		BOSE, Trachealhaken.....	315
		BOSE, Trachealwundspreizer	314
		BOUCHERON, Ohrspekula.....	53
		BOWMAN, Sonde.....	262, 293
		Brille, FRENZEL	22
		Bronchoskop.....	18
		Bronchoskopiezange,	
		CHEVALIER-JACKSON	356
		Bronchoskopiezange,	
		JACKSON-CHEVALIER	356
		BRUENINGS, Aufsatz	354
		BRUENINGS, Ohrspekula.....	55
		BRUENINGS, Septumzange	158
		BRUENINGS, Tonsillennmesser	287
		BRUENINGS, Tonsillenschnürer	301
		BRUENINGS,	
		Verlängerungsrohr.....	354
		BRUENINGS, Zungenspatel	268
		BRÜNINGS-BRUNK,	
		Wundhaken	263
		BRÜNINGS-LUCAS, Hohlmeißel	98
		Bruststütze, Erwachsene.....	335
		Bruststütze, Kinder	335
		Bruststütze, LEWY	336
		Bruststütze, NEGUS.....	280
		BUCHWALD, Zungenspatel	268
		BUCK, Fremdkörperzüngchen	73
		BUCK, Ohrkürette.....	68, 69
		Bügel, McIVOR Mundsperrer	277
		C	
		CANFIELD, Tonsillennmesser	287
		CAPLAN, Nasenschere	206
		CARPENTER,	
		Tonsillendissektor	291

CARPENTER, Tonsillenukleator.....	291	COTTLE, Septumlevatorium	224, 225	DOYEN-JANSEN (MOLT), Mundsperrerr.....	271
CASTROVIEJO, Mikro Nadelhalter	124	COTTLE, Septummeißel	231	Draht f. Tonsillenschnürer.....	302, 319
CAWOOD-MINNESOTA, Wangenhalter	268	COTTLE-JOSEPH, Septumlevatorium.....	224	Drahtbiegezügchen, McGEE.....	81
CHEVALIER-JACKSON, Bronchoskopiezange	356	COTTLE-KAZANJIAN, Knochensplitterzange	108, 208	Drahtbiegezügchen, SCHUHKNECHT	81
CHEVALIER-JACKSON, Trachealkanüle	316	COTTLE-MALTZ, Nasenraspel	239	Drahtschere, UNIVERSAL.....	118, 299
chirurgische Pinzette	95	COTTLE-MASING, Nasenschere.....	198	Drahtschlinge, Elektroden	35
chirurgische Pinzette, ADSON.....	97	COTTLE-NEIVERT, Nasenflügelhäkchen	252	Drahtschlingen.....	163
chirurgische Pinzette, GILLIES.....	151	CRAIG, Septumzange	158	DUCKBILL, Ohrzügchen	75
chirurgische Pinzette, GRAEFE	95	CRAIG-DOMNICK, Vomerzange..	158	DUPLAY, Tupferzange.....	295
chirurgische Pinzette, POTTS-SMITH	294	CRILE-WOOD, Nadelhalter.....	209	DUPUY-WEISS, Tonsillennadel...285	
chirurgische Pinzette, SEMKEN	95, 151	Cystoskop.....	16		
chirurgische Pinzette, STANDARD	95	D		E	
chirurgische Schere, STANDARD	117	DAUBENSPECK, scharfer Löffel..	258	EICKEN (KILLIAN) Spülkanüle....	212
CINELLI, Septummeißel.....	232	DAVIS-BOYLE, Mundsperrerr	274	Einsteckkonus, POLITZER.....	61
CITELLI, Stanze	109	DAVIS-BOYLE, Zungenspatel	273	Elektrode, Koagulation	34, 35
CLAR, Stirnlampe.....	26	DAVIS-MEYER, Mundsperrerr.....	277	Elektrode, bipolar.....	44
CLAUS, Tonsillennadel.....	285	DAY, Wundhäkchen.....	66	Elektroden	34, 35, 44
CLAUS-KILLIAN, Septummeißel	236	DEAN, Tonsillenschere	296	Elektroden, monopolar	34, 35
COAKLEY, Antrumkürette.....	256	Deckelhalter, REICHERT	343	Elektrodenballkoagulation	35
COAKLEY, Trokar.....	215	DENHART, Mundsperrerr	271	Elektrodendrahtschlinge.....	35
COLLIN, Zungenzange.....	270	DENIS-BROWNE, Tonsillenzange.....	283	Elektrodenlanzette.....	35
Columella-Pinzette, COTTLE	153	DERF, Nadelhalter.....	209	Elektrodennadel Mini	34, 35
COLVER, Tonsillenzange	281	DERLACKI, Gehörknöchelpinzette.....	97	Elektrodennadel, monopolar	35
CONVERSE, Nasenflügelhäkchen	252	Dermatom, HUMBY	221	Elektrodenschlinge Mini.....	34, 35
CONVERSE, Nasenmesser	217	Dermatom, SCHINK	220	Elevatorium.....	138
CONVERSE/WILMER/WALTER, feine Schere	194	Dermatom, SILVER	221	Elevatorium, BALLENGER.....	225
CORDES, Aufsatz	354	Dermatom, WATSON	221	Elevatorium, BALLENGER-HAJEK	225
COTTLE, Columella-Pinzette	153	Diagnostik-Besteck	48, 50-52	Elevatorium, BOIES.....	226
COTTLE, feine Schere	194	DIETER, Hammerkopfstanze	84	Elevatorium, COTTLE	224
COTTLE, Fingerringhäkchen.....	255	Dilatator, LABORDE	314	Elevatorium, COTTLE-JOSEPH...224	
COTTLE, Fixierpinzette.....	94, 152	Dilatator, RITTER-HALLE.....	261	Elevatorium, FREER	91, 223
COTTLE, Hammer.....	102, 260	Dilatator, TROUSSEAU.....	314	Elevatorium, GOLDMANN.....	226
COTTLE, Knorpelquetscher	237	Dilatator, TROUSSEAU-BABY	314	Elevatorium, GOLDMANN.....	226
COTTLE, Nasenflügelhäkchen	252, 253	DINGMAN, Nasenfeile	130	Elevatorium, GOLDMANN.....	226
COTTLE, Nasenhaken	251	DINGMAN, Nasenraspel	244	Elevatorium, HAJEK-BALLENGER	225
COTTLE, Nasenmesser	217	DINGMANN, Mundsperrerr.....	276	Elevatorium, HALLE	222
COTTLE, Nasenschere	198	DINGMANN, Zungendrücker.....	276	Elevatorium, HENKE	290
COTTLE, Nasenspekula.....	146, 147	Dissektor, ALDERYCE.....	290	Elevatorium, HOWARTH	224
COTTLE, Osteotom.....	100, 231	Dissektor, CARPENTER.....	291	Elevatorium, JOSEPH.....	224
		Dissektor, FISCH	93	Elevatorium, JOSEPH-COTTLE...224	
		Dissektor, HENKE	290	Elevatorium, KILLIAN	223, 225
		Dissektor, HURD	290	Elevatorium, LEMPERS.....	88
		Dissektor, LOPEZ-REINKE	290	Elevatorium, MASING	222
		DOUGHTY, Zugenspatel	279	Elevatorium, MCKENTY..92, 222, 224	
				Elevatorium, PENNINGTON.....	224
				Elevatorium, PIERCE	223
				Elevatorium, QUERVAIN	86
				Elevatorium, ROGER	222
				Elevatorium, SEBILEAU	86
				Elevatorium, SEWALL.....	226

Elevatorium, SINUS.....	223	feine Schere, WALTER/ WILMER/CONVERSE	194	FROHN, Watteträger.....	63
Elevatorium, YANKAUER	290	FERGUSSON, Saugrohr.....	213	FRONTAL, Nasensonde.....	261
Endoskope.....	14-18	FERGUSSON/FRAZIER, Saugrohr.....	125, 213	Führungsgabel, PLESTER	137
Enukleator, CARPENTER	291	FERRIS-SMITH-KERRISON, Stanze	181	FUJI-Kaltlichtkabeladapter	20
Ersatzflasche, KABIERSCHE.....	60	Fiberglas-Kaltlichtkabel	19	Fußplattenhäkchen, PLESTER	137
Ersatzklinge, Dermatome	220, 221	Fiberglas-Lichtträger.....	337, 338		
Ersatzklingen, LAFORCE	309	Fingerringhäkchen, COTTLE.....	255	G	
Ersatzlämpchen..	22, 26, 27, 332, 333	FINSEN, Wundspreizer	110	GALLAHER, Nasenraspel.....	243
Ersatzlämpchen f. FRENZEL	22	FISCH, Dissektor	93	Gaumenplatte, DAVIS-MEYER	277
EVES, Tonsillenschnürer	301	FISCH, Mikro Ohrschere	82	Gehörknöchelpinzette, DERLACKI.....	97
F		FISCH, Wundspreizer.....	112, 265	Gelenk, Bruststütze	335
Face-Lift-Schere, BEUSE.....	201	FISHER, Tonsillennmesser.....	286	Gelenkkloben, LEYLA.....	148
Face-Lift-Schere, GORNEY	200	Fixierpinzette, COTTLE	94, 152	GERZOG, Hammer	259
Face-Lift-Schere, GORNEY-FREEMAN	200	Fixierpinzette, GRAEFE	95, 151	GILLIES, chirurgische Pinzette....	151
Face-Lift-Schere, KAYE.....	201	Fixiervorrichtung, YASARGIL	57	GILLIES, Wundhäkchen.....	254
Face-Lift-Schere, PECK-JOSEPH.....	201	Flachmeißel.....	98, 99	GLABELLA, Nasenraspel.....	238
Fadengabel, Laryngoskopie	352	Flachmeißel, PARTSCH	99	GOLDMANN, Septumlevatorium.....	226
Fadengabel, NEGUS.....	304	Flachmeißel, WALTER	235	GOOD, Tonsillenschere.....	296
Fadenschere, LITTAUER	199	flexibler Spannm., YASARGIL.....	57	GORNEY, Face-Lift-Schere	200
Fadenschere, O'BRIEN.....	199	FOMON, Nasenflügelhäkchen.....	253	GORNEY, Präparierschere	116
Fadenschere, SPENCER.....	199	FOMON, Nasenraspel.....	240, 241	GORNEY-FREEMAN, Face-Lift-Schere.....	200
FARABEUF, Raspatorium.....	90	FOMON, Nasenschere	198	GRADLE, feine Schere.....	195
FARRELL, Watteträger	63	FOMON, Septumosteotom	232	GRAEFE, chirurgische Pinzette	95
FARRIOR, Ohrspekula	54	FRAENKEL, Aufsatz	354	GRAEFE, feine Schere.....	194
Faßzängchen, GREVEN	81	FRAENKEL, Kehlkopfzange.....	342	GRAEFE, Fixierpinzette	95, 151
Faßzängchen, Mikro.....	78	FRAZIER, Wundhäkchen	246	GRAEFE, Wundhäkchen	246
Faßzange, Kieferhöhle	176, 177	FRAZIER/FERGUSSON, Saugrohr.....	125, 213	GREENBERG-PAR, Blepharoplastikschere	202
Faßzange, LAHEY	318	FREER, Septumlevatorium	91, 223	GREVEN, Faßzängchen	81
Faßzange f. Optiken	15	FREER, Septummeißel	100, 230, 236	Griff, HUBER	354
FAULKNER, Antrumkürette	256	FREER, Septummesser	216	Griff, Kaltlicht	332
Feile, DINGMAN.....	130	FREER, Wundhäkchen	254	Griff, Kehlkopfspiegel	346
FEIN, Kehlkopfwatteträger	347	FREER-INGALS, Submukosamesser.....	219	Griff, Laryngoskop	336
feine Schere, BONN.....	192	Fremdkörperheber, QUIRE.....	73	Griff, Warmlicht.....	333
feine Schere, CONVERSE/WILMER/WALTER ..	194	Fremdkörperzängchen, BUCK	73	Griff, WULLSTEIN	127, 129
feine Schere, COTTLE	194	Fremdkörperzängchen, HARTMANN	75	GROSS, Ohrkürette.....	65
feine Schere, GRADLE.....	195	Fremdkörperzängchen, HARTMANN-HOFFMANN.....	75, 175	GROSS, Ohröffnung u. -Häkchen.....	65
feine Schere, GRAEFE.....	194	Fremdkörperzängchen, HARTMANN-WEINGÄRTNER	75	GRUBER, Ohrspekula	53
feine Schere, IRIS	117, 192	Fremdkörperzängchen, HARTMANN-WULLSTEIN	75, 175	GUILEN, Saugraspatorium.....	227
feine Schere, JOSEPH.....	116, 190	Fremdkörperzängchen, STRUEMPEL.....	75	Gummibirne, POLITZER	61
feine Schere, KILNER (RAGNELL)	191	FRENZEL, Nystagmus Brille	22	GUTHRIE, Wundhäkchen	246
feine Schere, KNAPP	193	FRENZEL, Zungenspatel	268		
feine Schere, LITTLER.....	194			H	
feine Schere, SANVENERO.....	190			HAJEK, Hammer	102
feine Schere, STEVENS.....	196			HAJEK, Septummeißel.....	236
feine Schere, STRABISMUS	116, 196			HAJEK-BALLENGER, Septumlevatorium.....	225
feine Schere, WAGNER	197			HAJEK-KOFLER, Stanze	182, 183
				Häkchen	25, 66, 135-137, 246-250

- Häkchen, BARBARA 135, 136
 Häkchen, BARSKY 248
 Häkchen, BERGMANN 250
 Häkchen, CONVERSE 252
 Häkchen, COTTLE 252-255
 Häkchen, COTTLE-NEIVERT 252
 Häkchen, DAY 66
 Häkchen, FOMON 253
 Häkchen, FRAZIER 246
 Häkchen, FREER 254
 Häkchen, GILLIES 254
 Häkchen, GRAEFE 246
 Häkchen, GROSS 65
 Häkchen, GUTHRIE 246
 Häkchen, HUMBY 248
 Häkchen, JOSEPH 247
 Häkchen, KILNER 253
 Häkchen, KLEINERT-KUTZ 247
 Häkchen, KNAPP 250
 Häkchen, Knopf 66
 Häkchen, LAHEY 246
 Häkchen, LANGE 255
 Häkchen, Laryngoskopie 352
 Häkchen, LUCAE 66, 250
 Häkchen, McGEE 136
 Häkchen Mikro, Laryngoskopie 353
 Häkchen, NEIVERT-COTTLE 252
 Häkchen, PLESTER 137
 Häkchen, HADEO 249
 Häkchen, ROLLET 250
 Häkchen, SHAMBAUGH 135
 Häkchen, TYRELL 246
 Häkchen, WAGENER 66
 Häkchen, WILLIGER 114
 Haken, AUFRICHT 251
 Haken, BOSE 315
 Haken, COTTLE 251
 Haken, ITERSON 315
 Haken, JACKSON 314
 Haken, MASING 251
 Haken, MASING-NEIVERT 251
 Haken, NEIVERT-MASING 251
 Haken, NEWS 315
 Haken, SCHOENBORN 317
 HALLE, scharfer Löffel 104, 258
 HALLE, Septumlevatorium 222
 HALLE-RITTER, Nasensonde 261
 HALSEY, Nadelhalter 209
 Haltearm, LEYLA 148
 Hammer 102, 259, 260
 Hammer, COTTLE 102, 260
 Hammer, GERZOG 259
 Hammer, HAJEK 102
 Hammer, MEAD 102, 259
 Hammer, PARTSCH 102, 260
 Hammer, QUISLING 260
 Hammerkopfstanze, DIETER 84
 Handgriff f. Laryngoskope 336
 Handgriff f. Stabinstrumente,
 Laryngoskopie 353
 HARTMANN,
 Fremdkörperzängchen 75
 HARTMANN, Nasenspekula 142
 HARTMANN, Nasentamponzange 154
 HARTMANN, Ohrkatheter 70
 HARTMANN, Ohrspekula 53
 HARTMANN, Ohrzängchen 74
 HARTMANN,
 scharfe Nasenzange 169
 HARTMANN, Stimmgabel 58
 HARTMANN, Tonsillenzange 307
 HARTMANN, Zungendrucker 269
 HARTMANN-HALLE,
 Nasenspekula 141
 HARTMANN-HOFFMANN,
 Fremdkörperzängchen 75, 175
 HARTMANN-WEINGÄRTNER,
 Fremdkörperzängchen 75
 HARTMANN-WULLSTEIN,
 Fremdkörperzängchen 75, 175
 Hebel, QUIRE 73
 Hebel, ZUFAL-JANSEN 65
 Hebel, ZUFAL 65
 HEINE-Kaltlichtkabeladapter 20
 HEISTER, Mundsperrler 271
 HENKE, Tonsillendissektor 290
 HENKE, Tonsillenelevatorium 290
 HEYMANN, Nasenschere 198
 HEYMANN, Septumzange 157
 HEYMANN-KNIGHT,
 Polypenzange 156
 HNO-Bohrer 30, 31
 HNO-Stirnleuchte 25
 HOFER, Wundhaken 289
 Hohlmeißel 98, 99
 Hohlmeißel, BRÜNING-S-LUCAS 98
 Hohlmeißel, FREER 236
 Hohlmeißel, LEXER MINI 100
 Hohlmeißel, PARTSCH 99
 Hohlmeißelzange,
 BANE-HARTMANN 106
 Hohlmeißelzange, BEYER 107
 Hohlmeißelzange,
 BLUMENTHAL 106
 Hohlmeißelzange, BOEHLER 107
 Hohlmeißelzange,
 KLEINERT-KUTZ 107
 Hohlmeißelzange, LEMPERT 107
 Hohlmeißelzange, LUER 106
 Hohlmeißelzange,
 ZAUFAL-JANSEN 107
 HOLINGER, Laryngoskop 339
 HOLZHEIMER, Wundspreizer 110
 Holzspatel 268
 HOUSE, Mikro Kürette 133
 HOUSE, Mikro Meßsonde 132
 HOUSE, Saugadapter 129
 HOUSE, Saugrohr 126, 214
 HOUSE-GELFOAM,
 Quetschzange 85
 HOWARTH, Septumlevatorium 224
 HUBER, Universalgriff 354
 HUMBY, Dermatome 221
 HUMBY, Wundhäkchen 248
 HURD, Tonsillendissektor 290
- I
 IBE+Winter, Adapter 20
 Injektionskanüle 337, 349
 IRIS, feine Schere 117, 192
 ITERSON, Trachealhaken 315
- J
 JACKSON, Kehlkopfpinzette 343
 JACKSON, Laryngoskope 340
 JACKSON, Trachealhaken 314
 JACKSON-CHEVALIER,
 Bronchoskopiezange 356
 JAMESON-REYNOLDS, Schere 191
 JANSEN, Nasentamponpinzette 150
 JANSEN, Raspatorium 91
 JANSEN, scharfer Löffel 103
 JANSEN, Wundspreizer 110
 JANSEN-MIDDLETON,
 Septumzange 159
 JANSEN-ZAUFAL, Ohrhebel 65
 JATHO, Nasenrachenzange 310
 JENNINGS, Mundsperrler 271
 JOBSON-HORNE, Watteträger 64
 JOSEPH (LEWIS), Nasenraspel 239
 JOSEPH, Elevatorium 222
 JOSEPH, feine Schere 116, 190
 JOSEPH, Nasenmesser 216, 217
 JOSEPH, Nasenraspel 238
 JOSEPH, Nasensäge 244, 245
 JOSEPH, Raspatorium 88

JOSEPH, Wundhäkchen	247	KILLIAN, Kehlkopfwatteträger	347	KRAUSE, Aufsatz	354
JOSEPH-COTTLE, Septumelevatorium.....	224	KILLIAN, Nasenspekula	144, 145	KRAUSE, Polypenschnürer.....	72, 162
JURASZ, Kehlkopfzange.....	342	KILLIAN, Septumelevatorium	223, 225	KRAUSE-VOSS, Polypenschnürer.....	162
JURASZ, Nasenrachenzange	311	KILLIAN, Spülkanüle	212	KROENIG, Zungenspatel	268
K		KILLIAN-CLAUS, Septummeißel.....	236	Kropffaßzange, LAHEY	318
Kabel, bipolar.....	39	KILLIAN-EICKEN, Spülkanüle.....	212	Kropfsonde, KOCHER.....	317
KABIERSKE, Ersatzflasche.....	60	KILNER (RAGNELL), feine Schere	191	Kugelelektrode.....	35
KABIERSKE, Ohrkanüle.....	60	KILNER, Nasenflügelhäkchen.....	253	Kugelenkklöben, LEYLA	148
KABIERSKE, Pulverbläser	60	KILNER-DOUGHTY, Mundsperrer	275	Kupplungskopf, LEYLA.....	148
KABIERSKE, Ventilball.....	60	KLEINERT-KUTZ, Hohlmeißelzange.....	107	Kürette, Antrum.....	256, 257
Kaltlichtkabel, Fiberglas.....	19	KLEINERT-KUTZ, Wundhäkchen.....	247	Kürette, BUCK.....	68, 69
Kaltlichtgriff	332	Kleintransformator	26	Kürette, COAKLEY.....	256
Kaltlichtkabeladapter	20	Klemme, BOETTCHER (SCHNIDT).....	281	Kürette, FAULKNER.....	256
Kaltlichtkabeladapter, ACM.....	20	Klemme, MASTIN.....	318	Küretten, HOUSE	133
Kaltlichtkabeladapter, Fuji.....	20	Klemme, MIKULICZ.....	283	L	
Kaltlichtkabeladapter, Heine	20	Klemme, NEGUS.....	281	LABORDE, Trachealdilatator.....	314
Kaltlichtkabeladapter, MLW	20	Klemme, SAWTELL.....	281	LAFORCE, Adenotom	309
Kaltlichtkabeladapter, Olympus	20	Klemme, SCHNIDT	281	LAHEY, Kropffaßzange.....	318
Kaltlichtkabeladapter, Pentax	20	Klemme, SCHNIDT (BOETTCHER).....	281	LAHEY, Wundhäkchen	246
Kaltlichtkabeladapter, Wolf	20	KNAPP, feine Schere.....	193	LAMBOTTE Mini, Osteotom	99, 229
Kanüle, CHEVALIER-JACKSON	316	KNAPP, Wundhäkchen.....	250	Lämpchen.....	22, 26, 27, 332, 333
Kanüle, EICKEN (KILLIAN).....	212	KNIGHT, Septumzange	157	LANGE, Aufsatz.....	354
Kanüle, Injektion.....	337, 349	Knochendraht	302	LANGE, Nasenflügelhäkchen.....	255
Kanüle, Kehlkopf	210, 306, 344	Knochensplitterzange, COTTLE-KAZANJIAN	108, 208	LANGENBECK, Ohrschlinge.....	65
Kanüle, KILLIAN	212	Knochensplitterzange, McINDOE	108, 208	LANGENBECK, Raspatorium.....	86
Kanüle, KILLIAN-EICKEN	212	Knochenstanze, CITELLI.....	109	Lanzette, Elektrode.....	35
Kanüle, LUER.....	316	Knochenstanze, FERRIS-SMITH-KERRISON	181	Lanzettenmesser, ROSEN	121
Kanüle, Mikro.....	125, 127	Knochenstanze, KERRISON	109	Laparoskop.....	18
Kanüle, Ohr, KABIERSKE	60	Knopfhäkchen.....	66	Lärmtrommel, BARANY.....	60
Kanüle, ROSEN.....	129	Knorpelfeile, DINGMAN.....	130	Laryngoskop, HOLINGER	339
Kanüle, Septum.....	210, 306, 344	Knorpelquetscher, COTTLE	237	Laryngoskop, JACKSON.....	340
Kanüle, WAGENER-MOSHER.....	315	Knorpelritzmesser, MASING.....	219	Laryngoskop.....	17, 334-336, 339-341
Katheter, HARTMANN.....	70	Koagulationselektrode, bipolar	44, 45	Laryngoskope	336
KAYE, Blepharoplastikschere.....	202	Koagulationselektrode Mini	35	Laryngoskope Handgriff	336
KAYE, Face-Lift-Schere	201	Koagulationssaugrohr.....	211, 348	Laryngoskopie Instrumente	352, 353
Kehlideckelhalter, REICHERT	343	KOCHER, Kropfsonde	317	Laryngoskopie, Injektionskanüle	337
Kehlkopfkanüle	210, 306, 344	KOCHER-LANGENBECK, Wundhaken	263	Laryngoskopie, Nadelhalter.....	349
Kehlkopfpinzette, JACKSON.....	343	KOENIG, Raspatorium	86	Laryngoskop-Optik	17
Kehlkopfpolypenschnürer	319	KOFLER-HAJEK, Stanze	182	Laryngoskop-Set	322, 325, 327, 329
Kehlkopfschere, KILLIAN	343	Kornzange	295	Laryngoskop-Spatel, McCOY	324, 331
Kehlkopfspiegel	346	Kornzange, DUPLAY	295	Laryngoskop-Spatel, McINTOSH	323, 328
Kehlkopfspiegel, MICHEL.....	345			Laryngoskop-Spatel, MILLER	326, 330
Kehlkopfwatteträger, FEIN.....	347			LED-Stirnlampe	27
Kehlkopfwatteträger, KILLIAN	347			LEMPERT, Elevatorium	88
Kehlkopfzange, FRAENKEL.....	342			LEMPERT, Hohlmeißelzange	107
Kehlkopfzange, JURASZ.....	342			LEMPERT, Raspatorium.....	88, 91
KELLY, Präparierschere	191			LEMPERT, scharfer Löffel	103
KERRISON, Stanze.....	109, 182			Leuchtklammer	338, 341
Kieferhöhlenfaßzange	176, 177				
KILLIAN, Kehlkopfschere	343				

LEWIS-JOSEPH, Nasenraspel.....	239	M	Messer, FREER.....	216
LEWY, Bruststütze.....	336	MALTZ (COTTLE), Nasenraspel ..	Messer, FREER-INGALS	219
LEXER Mini, Hohlmeißel	100	MALTZ, Nasenraspel.....	Messer, JOSEPH.....	216, 217
LEXER Mini, Osteotom.....	100	MARSCHIK, Tonsillenzange.....	Messer, MASING.....	219
LEXER, Osteotom	100, 228	MARTIN, Verbindungskabel,	Messer Mikro,	
LEYLA, Gelenkkloben	148	bipolar	Laryngoskopie	352, 353
LEYLA, Haltearm.....	148	MARTINI, scharfer Löffel	Messer, PLESTER.....	122
LEYLA, Kugelgelenkkloben.....	148	MASING, Elevatorium	Messer, POLITZER	71
LEYLA, Kupplungskopf.....	148	MASING, Knorpelritzmesser	Messer, HADEO.....	217
Lichtträger, Fiberglas	337, 338	MASING, Nasenhaken	Messer, ROSEN	120, 121
LICHTWITZ, Trokar	215	MASING, Nasenraspel	Messer, SCHUKNECHT	122
LINDEMANN, Nasensäge	245	MASING-NEIVERT,	Messer, SEXTON	71
Lippenhalter.....	270	Nasenhaken.....	Messer, St. CLAIR-THOMSON ...	309
LISTER (Sinus), Tamponzange	155	MASTIN, Muskelklemme	Messer, TABB.....	122
LITTAUER, Fadenschere	199	MAUNDER, Mundkeil.....	Messer, WULLSTEIN	122
LITTAUER, Ohrzängchen.....	74	MAY, Ophthalmoskop	Meßsonde Mikro, HOUSE.....	132
LITTAUER, Polypenzange.....	156	McCOY,	METZENBAUM,	
LITTLER, feine Schere.....	194	Laryngoskopspatel	Präparierschere	115, 188, 189, 297
Löffel.....	138	McGEE, Drahtbiegezängchen.....	MICHEL, Kehlkopfspiegel.....	345
Löffel, Antrum	257	McGEE, Häkchen.....	MICRODOME,	
Löffel, BARTH.....	104	McINDOE,	Koagulationselektrode bipolar	45
Löffel, DAUBENSPECK.....	258	anatomische Pinzette	MIDDELDORPF, Wundhaken.....	263
Löffel, GROSS.....	65	McINDOE,	MIDDLETON-JANSEN,	
Löffel, HALLE	104, 258	Knochensplitterzange	Septumzange	159
Löffel, JANSEN.....	103	McINTOSH, Laryngoskop-Set	Mikro Faßzängchen.....	78
Löffel, LEMPERT	103	327	Mikro Häkchen, Laryngoskopie ...	353
Löffel, MARTINI	105	McINTOSH,	Mikro Löffelzängchen,	
Löffel, SHEA	134	Laryngoskopspatel	WULLSTEIN.....	79
Löffel, SPRATT.....	103	McIVOR, Mundsperrerr.....	Mikro Löffelzange	131
Löffel, VOLKMANN.....	104	McIVOR, Zungenspatel	Mikro Messer, Laryngoskopie.....	353
Löffel, WILLIGER.....	105	McKENTY,	Mikro Nadelhalter,	
Löffelzängchen Mikro,		Septumelevatorium.....	BARRAQUER.....	123
WULLSTEIN	79	MEAD, Hammer	Mikro Nadelhalter,	
Löffelzange Mikro	131	Meißel.....	CASTROVIEJO	124
LOPEZ-REINKE,		Meißel, CINELLI	Mikro Nadelhalter, TITAN	123
Tonsillendissektor	290	Meißel, CLAUS-KILLIAN	Mikro Ohrscherchen,	
LOTHROP, Uvulahaken.....	288	Meißel, FREER.....	WULLSTEIN	83
LOVE, Uvulahaken	288	Meißel, HAJEK	Mikro Ohrscherre, BELLUCCI	80
LUBET-BARBON,		Meißel, KILLIAN-CLAUS	Mikro Ohrscherre, SHEA	80
Nasentamponzange	154	Meißel, PASSOW	Mikro Ohrscheren	80, 82, 83, 131
LUC, Siebbeinzange.....	157	Meißel, SILVER	Mikro Ohrzängchen	76, 77
LUCAE, Ohr-Nasen-Pinzette ..94,	152	Meißel, WALTER	Mikro Ohrzange.....	131
LUCAE, Stimmgabel.....	59	Meißel, WEST	Mikro Rohrschaftzange.....	350, 351
LUCAE, Trommelfellnadel	70	Messer, ABRAHAM	Mikro Sichelmesser,	
LUCAE, Wundhäkchen.....	66, 250	Messer, BALLENGER	Laryngoskopie	352
LUER, Hohlmeißelzange	106	Messer, BARNHILL	Mikro Kürette, HOUSE	133
LUER, Trachealkanüle.....	316	Messer, BECKMANN.....	Mikro Meßsonde, HOUSE.....	132
Luftdusche, POLITZER	61	Messer, BRUENINGS.....	Mikro Ohrzängchen	75-81
LUNIATSCHEK, Tamponstopfer...292		Messer, CANFIELD	Mikro Saugkanüle.....	125, 127
Lupe, BRUENINGS	55	Messer, CONVERSE.....	Mikro Schere, HADEO	203
		Messer, COTTLE.....	Mikro Scheren	119, 203-205
		Messer, FISHER.....	Mikro Scheren, TITAN	203-205

MIKULICZ, Tonsillenklemme	283	Nasenhäkchen, CONVERSE	252	Nasenschere, HEYMANN	198
MILLER, Laryngoskop-Set ...	325, 329	Nasenhäkchen, COTTLE	252-254	Nasensonde, FRONTAL	261
MILLER, Laryngoskopspatel		Nasenhäkchen,		Nasensonde, RITTER-HALLE	261
.....	326, 330	COTTLE-NEIVERT	252	Nasensonde, SINUS	261
MILLER, Raspatorium	92	Nasenhäkchen, FOMON	253	Nasensonde, WILDER	261
Miniatur-Stirnleuchte	23	Nasenhäkchen, KILNER	253	Nasenspekula	140-147
MINI-LAMBOTTE, Osteotom ..	99, 229	Nasenhäkchen, LANGE	255	Nasenspekula, COTTLE	146, 147
MLW-Kaltlichtkabeladapter	20	Nasenhäkchen,		Nasenspekula, HARTMANN	142
Mod. VIENNA, Nasenspekula	143	NEIVERT-COTTLE	252	Nasenspekula,	
MOLLISON, Wundspreizer	112	Nasenhaken, AUFRICHT	251	HARTMANN-HALLE	141
MOLT, Mundsperrerr	271	Nasenhaken, COTTLE	251	Nasenspekula, KILLIAN	144, 145
MOLT, Raspatorium	92	Nasenhaken,		Nasenspekula, HADEO	144
MORITZ-SCHMIDT,		MASING-NEIVERT	251	Nasenspekula, THUDICHUM	140
Zungendrücker	269	Nasenhaken,		Nasenspekula, TIECK-HALLE	144
Mundkeil, MAUNDER	280	NEIVERT-MASING	251	Nasenspekula, VIENNA	143
Mundsperrerr, DAVIS-BOYLE	274	Nasenmesser, CONVERSE	217	Nasenspekula, VOLTOLINI	140
Mundsperrerr, DAVIS-MEYER	277	Nasenmesser, COTTLE	217	Nasentamponzange,	
Mundsperrerr, DENHART	271	Nasenmesser, JOSEPH	216, 217	HARTMANN	154
Mundsperrerr, DINGMANN	276	Nasen-Ohr-Pinzette, LUCAE ..	94, 152	Nasentamponzange,	
Mundsperrerr, DOYEN-JANSEN ..	271	Nasenolive, POLITZER	61	LUBET-BARBON	154
Mundsperrerr, HEISTER	271	Nasenpinzette, LUCAE	94, 152	Nasentamponzange,	
Mundsperrerr, JENNINGS	271	Nasenpinzette,		WESTMACOTT	154
Mundsperrerr,		TROELTSCH-WILDE	94, 152	Nasentamponzinzette, JANSEN ..	150
KILNER-DOUGHTY	275	Nasenpinzette, WILDE		Nasentamponzinzette,	
Mundsperrerr, McIVOR	277	(TROELTSCH)	94, 152	TROELTSCH	149
Mundsperrerr, MOLT	271	Nasenrachenzange, JATHO	310	Nasenzange, ASCH	160
Mundsperrerr, ROSER-KOENIG ..	271	Nasenrachenzange, JURASZ	311	Nasenzange, Biopsie	167
Muskelklemme, MASTIN	318	Nasenrachenzänge,		Nasenzange, BLAKESLEY ..	164, 168
		St. CLAIR-THOMSON	310	Nasenzange, durchschneidend ..	178
		Nasenraspel, MALTZ (COTTLE) ..	239	Nasenzange, HARTMANN	169
		Nasenraspel, (JOSEPH (LEWIS) ..	239	Nasenzange, SCHMEDEN	169
		Nasenraspel, AUFRICHT	239	Nasenzange, STRUYCKEN	169
		Nasenraspel, COTTLE-MALTZ ..	239	Nasenzange, TAKAHASHI	165
		Nasenraspel, DINGMAN	244	Nasenzange, WALSHAM	160
		Nasenraspel, FOMON	240, 241	Nasenzange,	
		Nasenraspel, GALLAHER	243	WATSON-WILLIAMS	166
		Nasenraspel, GABELLA	238	Nasenzange,	
		Nasenraspel, JOSEPH	238	WEIL-BLAKESLEY	164, 168
		Nasenraspel, LEWIS-JOSEPH	239	Nasenzangen	169-174
		Nasenraspel, MALTZ	238	Nasopharyngo-Laryngoskop	14
		Nasenraspel, MASING	242	NEGUS, Bruststütze	280
		Nasenraspel, PARKES	238	NEGUS, Fadengabel	304
		Nasensäge, JOSEPH	244, 245	NEGUS, Tonsillenklemme	281
		Nasensäge, LINDEMANN	245	NEIVERT-ANDERSON,	
		Nasenschere, CAPLAN	206	Osteotom	233
		Nasenschere,		NEIVERT-COTTLE,	
		COTTLE-MASING	198	Nasenflügelhäkchen	252
		Nasenschere,		NEIVERT-MASING,	
		MASING-COTTLE	198	Nasenhaken	251
		Nasenscheren	187	NEWS, Trachealhaken	315
		Nasenschere, COTTLE	198	Non-Stick, Saugkoagulator,	
		Nasenschere, FOMON	198	monopolar	43

NOYES, Polypenzange	155	Ohrzängchen, WULLSTEIN	79	Pinzette, JANSEN	150
Nystagmus Brille, FRENZEL	22	Ohrzange Mikro	131	Pinzette, LUCAE	94, 152
O		Olympus-Kaltlichtkabeladapter	20	Pinzette, McINDOE	151
O'BRIEN, Fadenschere	199	Ophtalmologie Schere	195	Pinzette, POTTS-SMITH	294
OBWEGESER, Osteotom	234	Ophtalmoskop, MAY	49	Pinzette, SEMKEN	95, 151
Ohrhäkchen	66	Ophthalmoskop, UNI II	49	Pinzette, TROELTSCH	149
Ohrhäkchen, DAY	66	OP-Laryngoskope	334-336, 341	Pinzette,	
Ohrhäkchen, GROSS	65	Osteotom	98	TROELTSCH-WILDE	94, 152
Ohrhäkchen, WAGENER	66	Osteotom,		Pinzette, WILDE	
Ohrhebel, JANSEN-ZAUFAL	65	ANDERSON-NEIVERT	233	(TROELTSCH)	94, 152
Ohrhebel, ZAUFAL	65	Osteotom, COTTLE	100, 231	Pinzette, bipolar	36-38, 40, 41
Ohrhebel, ZAUFAL-JANSEN	65	Osteotom, FOMON	232	Pinzette, COTTLE	94, 152, 153
Ohrkanüle, KABIERSKE	60	Osteotom, LEXER	228	Pinzette, Uhrmacher	96
Ohrkatheter, HARTMANN	70	Osteotom, LEXER MINI	100	PLESTER, Antrumhäkchen	137
Ohrkürette, BUCK	68, 69	Osteotom, MINI-LAMBOTTE	99, 229	PLESTER, Führungsgabel	137
Ohrkürette, GROSS	65	Osteotom,		PLESTER, Fußplattenhäkchen	137
Ohrlöffel, GROSS	65	NEIVERT-ANDERSON	233	PLESTER, Rundmesser	122
Ohrmesser, POLITZER	71	Osteotom, OBWEGESER	234	PLESTER, Saugrohr	126
Ohrmesser, SEXTON	71	Osteotom, RUBIN	234	PLESTER, Schaber	137
Ohr-Nasen-Pinzette, LUCAE	94, 152	Osteotom, SHEEHAN	101, 232	PLESTER, Wundspreizer	113, 264
Ohrolive, POLITZER	61	Osteotom, OSTROEM, Antrumstanze	184	POLITZER, Einsteckkonus	61
Ohrpinzette,		Otoskop	17, 48	POLITZER, Gummibirne	61
TROELTSCH-WILDE	94, 152	Otoskop,		POLITZER, Luftdusche	61
Ohrpinzette,		Diagnostik-Besteck UNI I	48	POLITZER, Nasenolive	61
WILDE (TROELTSCH)	94, 152	Otoskop,		POLITZER, Ohrmesser	71
Ohrschere Mikro, BELLUCCI	80	Diagnostik-Besteck UNI III	50	POLITZER, Ohrolive	61
Ohrschere Mikro, SHEA	80	P		POLITZER, Ohrspekula	53
Ohrschere, FISCH	82	PARKES, Nasenraspel	238	POLITZER, Trommelfellnadel	70, 71
Ohrscheren Mikro	80, 82, 83, 131	PARTSCH, Flachmeißel	99	Polypenschnürer, Kehlkopf	319
Ohrschlinge, BILLEAU	65	PARTSCH, Hammer	102, 260	Polypenschnürer, KRAUSE	72, 162
Ohrschlinge, LANGENBECK	65	PARTSCH, Hohlmeißel	99	Polypenschnürer,	
Ohrschlinge, SHAPLEIGH	67	PASSOW,		KRAUSE-VOSS	162
Ohrschlinge, WEBER-LOCH	67	Blutstillungsmeißel	98, 235	Polypenschnürer,	
Ohrsonde, STACKE	63	PECK-JOSEPH,		VOSS-KRAUSE	162
Ohrspekula, BRUENINGS	55	Face-Lift-Schere	201	Polypenschnürer, WILDE	72, 163
Ohrspekula, FARRIOR	54	PEET, Nasenraspel	238	Polypenzange, FRAENKEL	342
Ohrspekula, GRUBER	53	PENNINGTON,		Polypenzange, JURASZ	342
Ohrspekula, HARTMANN	53	Septumelevatorium	224	Polypenzange,	
Ohrspekula, POLITZER	53	Pentax-Kaltlichtkabeladapter	20	KEYMANN-KNIGHT	156
Ohrspekula, SIEGLE	56	PERWITZSCHKY,		Polypenzange, LITTAUER	156
Ohrspekula, TOYNBEE	53	Speichelgangschere	298	Polypenzange, NOYES	155
Ohrspekula, BOUCHERON	53	Pharyngoskop	16	POTTS-SMITH,	
Ohrspekulahalter, YASARGIL	57	PIERCE, Septumelevatorium	223	anatomische Pinzette	294
Ohrspritze	61, 62	Pinzette, ADSON	97	POTTS-SMITH,	
Ohrspritze, REINER	61	Pinzette, anatomisch	95	chirurgische Pinzette	294
Ohrspritze, selbstfüllend	62	Pinzette, chirurgisch	95	Präparierschere, GORNEY	116
Ohrtrichterhalter, YASARGIL	57	Pinzette, COTTLE	153	Präparierschere, KELLY	191
Ohrzängchen Mikro	75-81	Pinzette, DERLACKI	97	Präparierschere,	
Ohrzängchen, DUCKBILL	75	Pinzette, GILLIES	151	METZENBAUM	115, 188, 189, 297
Ohrzängchen, HARTMANN	74	Pinzette, GRAEFE	95, 151	Präparierschere,	
Ohrzängchen, LITTAUER	74	Pinzette, JACKSON	343	REYNOLDS (JAMESON)	191
				PRINCE, Tonsillenschere	296

Pulverbläser, KABIERSKE	60	Hadeo, Wundhäkchen.....	249	Saugrohr, HOUSE	126, 214
Pulverbläser, UNIVERSAL	60	REICHERT, Kehldeckelhalter	343	Saugrohr, Koagulation	211, 348
Q		REINER, Ohrspritze	61	Saugrohr, PLESTER.....	126
QUERVAIN, Elevatorium	86	REYNOLDS (JAMESON),		Saugrohr, ROSEN	129
Quetschzange,		Präparierschere	191	Saugrohr, WULLSTEIN	127
HOUSE-GELFOAM.....	85	RFO-Schölly-Volpi, Adapter.....	20	Saugrohr, YANKAUER	284
Quetschzange, RUBIN	161	Ring f. Bruststütze	335	Saugrohr, ZÖLLNER	125
QUIRE, Fremdkörperhebel.....	73	RING, Zungenspatel.....	272	Saugrohre.....	125-129
QUISLING, Hammer.....	260	Ringmesser, BÄRNHILL	308	SAWTELL, Tonsillenklemme	281
R		Ringmesser, BECKMANN	308	Schaber, PLESTER	137
RAGNELL-KILNER,		Ringmesser,		Schälmesser Mikro,	
feine Schere	191	St. CLAIR-THOMSON	309	Laryngoskopie	352
Rasierklingen.....	221	RITTER-HALLE, Nasensonde.....	261	scharfe Nasenzange,	
Raspatorien	86-92, 138, 227	ROEDER, Tonsillenschnürer	303	SCHMEDEN.....	169
Raspatorien, Ferrozellgriff	89	ROGER, Septumlevatorium	222	scharfe Nasenzange,	
Raspatorium, FARABEUUF	90	Rohr, BRUENINGS.....	354	TAKAHASHI	165
Raspatorium, GUILLEN.....	227	Rohrschaftzange Mikro.....	350, 351	scharfe Nasenzange,	
Raspatorium, JANSEN	91	ROLLET, Wundhäkchen	250	WATSON-WILLIAMS.....	166
Raspatorium, JOSEPH.....	88	ROSEN, Lanzettenmesser	121	scharfe Nasenzangen....	165, 169-174
Raspatorium, KOENIG	86	ROSEN, Messer.....	120, 121	scharfe Nasenzangen,	
Raspatorium, LANGENBECK.....	86	ROSEN, Nadel	136	HARTMANN	169
Raspatorium, LEMPERT	88	ROSEN, Raspatorium	93	scharfer Löffel, BARTH.....	104
Raspatorium, MILLER	92	ROSEN, Saugrohr	129	scharfer Löffel, DAUBENSPECK..	258
Raspatorium, MOLT	92	ROSER-KOENIG, Mundsperrer	271	scharfer Löffel, HALLE	104, 258
Raspatorium, ROSEN	93	ROUX-BABY, Wundhaken.....	263	scharfer Löffel, JANSEN.....	103
Raspatorium z. Saugen,		RUBIN, Osteotom.....	234	scharfer Löffel, LEMPERT	103
Laryngoskopie	353	RUBIN, Septumquetschzange.....	161	scharfer Löffel, MARTINI	105
Raspatorium, WILLIGER	87	Rundmesser, PLESTER.....	122	scharfer Löffel, SHEA	134
Raspatorium, WULLSTEIN.....	92	RUSSEL-DAVIS, Zungenspatel....	278	scharfer Löffel, SPRATT.....	103
Raspel, AUFRICHT	239	RYDEL-SEIFFERT, Stimmgabel	59	scharfer Löffel, VOLKMANN.....	104
Raspel, COTTLE-MALTZ	239	S		scharfer Löffel, WILLIGER.....	105
Raspel, DINGMAN	244	Säge, JOSEPH.....	244, 245	SCHHEINMANN, Aufsatz.....	354
Raspel, FOMON	240, 241	Säge, LINDEMANN	245	Scherchen Mikro, WULLSTEIN	83
Raspel, GALLAHER	243	SANVENERO, feine Schere.....	190	Schere, BABY-METZENBAUM	188
Raspel, GLABELLA.....	238	Sattelhäkchen, COTTLE.....	252	Schere, BELLUCCI.....	80
Raspel, JOSEPH	238	Saugadapter, HOUSE	129	Schere, BEUSE.....	201
Raspel, JOSEPH (LEWIS)	239	Saugball, BRUENINGS	55	Schere, BOETTCHER.....	296
Raspel, LEWIS-JOSEPH.....	239	Sauggriff, WULLSTEIN.....	127, 129	Schere, BONN.....	192
Raspel, LEWIS-JOSEPH.....	239	Saugkanüle Mikro.....	125, 127	Schere, CAPLAN.....	206
Raspel, MALTZ	238	Saugkoagulator,		Schere, chirurgisch,	
Raspel, MALTZ (COTTLE)	239	Non-Stick, monopolar	43	STANDARD	117
Raspel, MASING	242	Saugpinzette, bipolar.....	42	Schere, CONVERSE/	
Raspel, PARKES	238	Saugraspatorium, GUILLEN.....	227	WILMER/WALTER.....	194
Raspel, PEET	238	Saugraspatorium,		Schere, COTTLE.....	194, 198
Raspel, WIENER	238	Laryngoskopie	353	Schere, COTTLE-MASING.....	198
Rauchabsaugrohr.....	338	Saugrohr.....	126, 348	Schere, DEAN	296
Hadeo, Mikro Schere.....	203	Saugrohr, BABY-YANKAUER.....	284	Schere, FISCH	82
Hadeo, Nasenspekula.....	144	Saugrohr, BARON	128	Schere, FOMON.....	198
Hadeo, Sichelmesser.....	217	Saugrohr, FERGUSSON	213	Schere, GOOD	296
Hadeo, Stimmgabel.....	58	Saugrohr,		Schere, GORNEY.....	116, 200
Hadeo, Watteträger.....	64	FRAZIER/FERGUSSON	125, 213	Schere, GORNEY-FREEMAN	200
				Schere, GRADLE	195

Schere, GRAEFE	194	Schnürer, BRUENINGS.....	301	Septummeißel, COTTLE	231
Schere, GREENBERG-PAR.....	202	Schnürer, EVES.....	301	Septummeißel, FOMON.....	232
Schere, HEYMANN	198	Schnürer, KRAUSE	162	Septummeißel, FREER	100, 230, 236
Schere, IRIS	117, 192	Schnürer, KRAUSE-VOSS	162	Septummeißel, HAJEK.....	236
Schere, JOSEPH.....	116, 190	Schnürer, ROEDER.....	303	Septummeißel, KILLIAN-CLAUS..	236
Schere, KAYE.....	201, 202	Schnürer, VOSS-KRAUSE	162	Septummeißel, SHEEHAN	232
Schere, KELLY	191	Schnürer, WILDE.....	163	Septummeißel, SILVER.....	233
Schere, KILLIAN.....	343	SCHOENBORN, Schilddrüsenhaken.....	317	Septummeißel, WEST	236
Schere, KILNER (RAGNELL).....	191	Schölly-Volpi-RFO, Adapter.....	20	Septummesser, COTTLE	217
Schere, KNAPP.....	193	SCHUHKNECHE, Biegegerät.....	85	Septummesser, FREER	216
Schere, LITTAUER.....	199	SCHUHKNECHE, Drahtbiegezügchen	81	Septumosteotom, COTTLE	231
Schere, LITTLER.....	194	SCHUKNECHT, Messer	122	Septumosteotom, FOMON.....	232
Schere, MASING-COTTLE.....	198	SCHUKNECHT, Sichelmesser	122	Septumosteotom, SHEEHAN	101, 232
Schere, METZENBAUM.....	115, 188, 189, 297	SCHUMACHER, Aufsatz	354	Septumquetschzange, RUBIN.....	161
Schere, O'BRIEN.....	199	Schwingmesser, BALLENGER.....	218	Septumrichtzange, ASCH.....	160
Schere, Ophthalmologie.....	195	SEBILÉAU, Elevatorium	86	Septumrichtzange, WALSHAM	160
Schere, PECK-JOSEPH.....	201	SEIFERT, Aufsatz	354	Septumzange, BRUENINGS	158
Schere, PERWITZSCHKY.....	298	SEIFFERT-RYDEL, Stimmgabel	59	Septumzange, CRAIG	158
Schere, PRINCE.....	296	SEMKEN, anatomische Pinzette	95	Septumzange, HEYMANN	157
Schere, HADEO	203	SEMKEN, chirurgische Pinzette	95, 151	Septumzange, JANSEN-MIDDLETON	159
Schere, REYNOLDS (JAMESON).....	191	Septumelevatorium, BALLENGER.....	225	Septumzange, KNIGHT.....	157
Schere, SANVENERO.....	190	Septumelevatorium, BALLENGER-HAJEK	225	Septumzange, MIDDLETON-JANSEN	159
Schere, SHEA.....	80	Septumelevatorium, COTTLE	224, 225	Set, Laryngoskope	322, 325, 327, 329
Schere, SPENCER.....	199	Septumelevatorium, COTTLE-JOSEPH	224	SEWALL, Elevatorium	226
Schere, STEVENS	196	Septumelevatorium, FREER ..	91, 223	SEXTON, Ohrmesser	71
Schere, STRABISMUS.....	116, 196	Septumelevatorium, GOLDMANN.....	226	SHAMBAUGH, Hákchen	135
Schere, Tumor	207	Septumelevatorium, HAJEK-BALLENGER	225	SHAPLEIGH, Ohrschlinge.....	67
Schere, UNIVERSAL.....	118, 299	Septumelevatorium, HALLE	222	SHEA, Mikro Ohrschere	80
Schere, WAGNER	197	Septumelevatorium, HOWARTH ..	224	SHEA, scharfer Löffel	134
Schere, WILMER/ WALTER/CONVERSE.....	194	Septumelevatorium, JOSEPH-COTTLE	224	SHEEHAN, Septumosteotom	101, 232
Schere Mikro	119, 203-205	Septumelevatorium, KILLIAN	223, 225	Sichelmesser	121, 122
Schere, Nase	187	Septumelevatorium, McKENTY.....	92, 222, 224	Sichelmesser Mikro, Laryngoskopie	352
Schere, Ohr	80, 82, 83, 131	Septumelevatorium, PENNINGTON.....	224	Sichelmesser, HADEO	217
Schere, TITAN	203-205	Septumelevatorium, PIERCE	223	Sichelmesser, SCHUKNECHT	122
Schilddüsenhaken, SCHOENBORN.....	317	Septumelevatorium, ROGER	222	Sichelmesser, WULLSTEIN.....	122
SCHINK, Dermatome	220	Septumelevatorium, SINUS.....	223	Siebbeinzange, LUC.....	157
Schlinge, BILLEAU	65	Septumkanüle.....	210, 306, 344	Siebbeinzange, TAKAHASHI.....	165
Schlinge, Elektrode Mini.....	34, 35	Septummeißel, CINELLI.....	232	Siebbeinzange, WEIL-BLAKESLEY.....	164
Schlinge, LANGENBECK	65	Septummeißel, CLAUS-KILLIAN ..	236	Siebbeinzangen, WATSON-WILLIAMS.....	166
Schlinge, SHAPLEIGH	67			SIEGLE, Ohrspekula	56
Schlinge, WEBER-LOCH	67			Silikonschlauch f. McIVOR	
Schlingen, Polypenschnürer.....	72			Mundsperrer	277
SCHMEDEN, scharfe Nasenzange.....	169			SILVER, Dermatome	221
SCHNIDT (BOETTCHER), Tonsillenklemme	281				
SCHNIDT, Tonsillenklemme	281				
Schnürdraht.....	163				

- SILVER, Septummeißel.....233
 Sinoskopietrokar.....215
 SINUS, Nasensonde.....261
 SINUS, Septumlevatorium.....223
 Sinusdilator, HALLE-RITTER.....261
 Sinuskop.....15
 Sinuskopiezange.....178, 179
 SLUDER-BALLENGER,
 Tonsillotom.....305
 SMITH-KERRISON, Stanze.....181
 Sonde, BOWMAN.....262, 293
 Sonde, FRONTAL.....261
 Sonde, KOCHER.....317
 Sonde, RITTER-HALLE.....261
 Sonde, SINUS.....261
 Sonde, STACHE.....63
 Sonde, WILDER.....261
 Spannam, YASARGIL.....57
 Spannplatte, Dermatome.....220
 Spatel, BRUENINGS.....268
 Spatel, BUCHWALD.....268
 Spatel, DOUGHTY.....279
 Spatel, FRENZEL.....268
 Spatel, KROENIG.....268
 Spatel, Laryngoskop.....323-331
 Spatel, McIVOR.....277
 Spatel, RING.....272
 Spatel, RUSSEL-DAVIS.....278
 Speichelgangschere,
 PERWITZSCHKY.....298
 SPENCER, Fadenschere.....199
 Spiegel, CLAR.....26
 Spiegel, MICHEL.....345
 Spiegel, ZIEGLER.....23
 SPRATT, scharfer Löffel.....103
 Spritze, Tonsille.....210, 306, 344
 Spülkanüle, EICKEN (KILLIAN).....212
 Spülkanüle, KILLIAN.....212
 Spülkanüle, KILLIAN-EICKEN.....212
 St. CLAIR-THOMSON,
 Nasenrachenzange.....310
 St. CLAIR-THOMSON,
 Ringmesser.....309
 STACHE, Ohrsonde.....63
 STANDARD, Pinzette, chirurgisch.....95
 STANDARD, Schere, chirurgisch.....117
 Stanze, Antrum.....184, 185
 Stanze, CITELLI.....109
 Stanze, DIETER.....84
 Stanze,
 FERRIS-SMITH-KERRISON.....181
 Stanze, HAJEK-KOFLER.....182, 183
 Stanze, KERRISON.....109, 182
 Stanze, KOFLER-HAJEK.....182
 Stanze, OSTROEM.....184
 Stanze, SMITH-KERRISON.....181
 Stanze, Zirkular.....186
 STERNBERG, Wangenhalter.....270
 STEVENS, feine Schere.....196
 STEVENS, Supercuttschere.....196
 Stichkoagulationselektrode,
 bipolar.....44
 Stimmgabel, HARTMANN.....58
 Stimmgabel, LUCAE.....59
 Stimmgabel, HADEO.....58
 Stimmgabel, RYDEL-SEIFFERT.....59
 Stimmgabel, SEIFFERT-RYDEL.....59
 Stimmgabeln.....58, 59
 Stirnlampe.....26, 27
 Stirnlampe, CLAR.....26
 Stirnlampe, LED.....27
 Stirnlampe, XENON.....27
 Stirnleuchte.....24-27
 Stirnspiegel, ZIEGLER.....23
 Stirnstreifen f. ZIEGLER.....23
 Stopfer, LUNIATSCHEK.....292
 Storz-Aesculap-
 Kaltlichtkabeladapter.....20
 Stößel.....98
 STRABISMUS,
 feine Schere.....116, 196
 STRUEMPEL,
 Fremdkörperzangchen.....75
 STRUYCKEN,
 scharfe Nasenzange.....169
 Stützstange, Laryngoskop.....335
 Submukosamesser,
 FREER-INGALS.....219
 Supercuttschere,
 BABY-METZENBAUM.....188
 Supercuttschere, STEVENS.....196
 Supercuttschere, WAGNER.....197
- T**
 TABB, Messer.....122
 TAKAHASHI,
 scharfe Nasenzange.....165
 Tamponpinzette, JANSEN.....150
 Tamponpinzette, TROELTSCH.....149
 Tamponstopfer, LUNIATSCHEK.....292
 Tamponzange, LISTER (Sinus).....155
 Tamponzange, LUBET-BARBON.....154
 Tamponzange, TILLEY.....74, 155
 Tamponzange, WESTMACOTT.....154
 Tele-Laryngoskop.....17
 THILENIUS, Tonsillenzange.....283
 THUDICHUM, Nasenspekula.....140
 TIECK-HALLE, Nasenspekula.....144
 TILLEY, Tamponzange.....74, 155
 TITAN Mikro Nadelhalter.....123
 TITAN Mikro Scheren.....203-205
 TOBOLD, Zungendrucker.....270
 Tonsillendissektor,
 ALDERDYCE.....290
 Tonsillendissektor,
 CARPENTER.....291
 Tonsillendissektor, HENKE.....290
 Tonsillendissektor, HURD.....290
 Tonsillendissektor,
 LOPEZ-REINKE.....290
 Tonsillendraht.....302, 319
 Tonsillenelevatorium, HENKE.....290
 Tonsillenelevatorium,
 YANKAUER.....290
 Tonsillenukleator,
 CARPENTER.....291
 Tonsillenklemme,
 BOETTCHER (SCHNIDT).....281
 Tonsillenklemme, MIKULICZ.....283
 Tonsillenklemme, NEGUS.....281
 Tonsillenklemme, SAWTELL.....281
 Tonsillenklemme, SCHNIDT.....281
 Tonsillenklemme, SCHNIDT
 (BOETTCHER).....281
 Tonsillennadel, ABRAHAM.....287
 Tonsillennadel, BRUENINGS.....287
 Tonsillennadel, CANFIELD.....287
 Tonsillennadel, FISHER.....286
 Tonsillennadel.....210, 306, 344
 Tonsillennadel, CLAUS.....285
 Tonsillennadel, DUPUY-WEISS.....285
 Tonsillennadel, NAGER.....286
 Tonsillenschere, BOETTCHER.....296
 Tonsillenschere, DEAN.....296
 Tonsillenschere, GOOD.....296
 Tonsillenschere, PRINCE.....296
 Tonsillenschnürer, BRUENINGS.....301
 Tonsillenschnürer, EVES.....301
 Tonsillenschnürer, ROEDER.....303
 Tonsillenschnürer, TYDING.....300
 Tonsillenspritze.....210, 306, 344
 Tonsillenzange, ABRAHAM.....282
 Tonsillenzange, BALLENGER.....281
 Tonsillenzange, BLOHMKE.....281
 Tonsillenzange, COLVER.....281
 Tonsillenzange, DENIS-BROWN.....283

Tonsillenzange, HARTMANN	307	V	WILDE, Polypenschnürer	72, 163
Tonsillenzange, MARSCHIK	282	Ventilball, KABIERSKE	WILDER, Nasensonde	261
Tonsillenzange, THILENIUS	283	Verbindungskabel, bipolar	WILLIGER, Raspatorium	87
Tonsillenzange, TYDING	282	Verlängerungsrohr,	WILLIGER, scharfer Löffel	105
Tonsillenzange, WHITE	281	BRUENINGS	WILLIGER, Wundhaken	114
Tonsillotom,		VIENNA, Nasenspekula	Winter+IBE, Adapter	20
BALLENGER-SLUDER	305	VOLKMANN, scharfer Löffel	Wolf-Kaltlichtkabeladapter	20
TOYNBEE, Ohrspekula	53	Volpi-Schölly-RFO, Adapter	WULLSTEIN,	
Trachealdilatator,		VOLTOLINI, Nasenspekula	Mikro Löffelzängchen	79
TROUSSEAU-BABY	314	Vomerzange,	WULLSTEIN,	
Trachealhaken, BOSE	315	CRAIG-DOMINICK	Mikro Ohrscheren	83
Trachealhaken, JACKSON	314	VOSS-KRAUSE,	WULLSTEIN,	
Trachealhaken, NEWS	315	Polypenschnürer	Mikro Ohrzängchen	79
Trachealkanüle,			WULLSTEIN, Raspatorium	92
CHEVALIER-JACKSON	316	W	WULLSTEIN, Sauggriff	127, 129
Trachealkanüle, LUER	316	WAGENER, Wundhäkchen	WULLSTEIN, Saugrohr	127
Trachealkanüle,		WAGENER-MOSHER,	WULLSTEIN, Sichelmesser	122
WAGENER-MOSHER	315	Trachealkanüle	WULLSTEIN, Wundspreizer	113
Trachealwundspreizer, BOSE	314	WAGNER, feine Schere	Wundhäkchen, BARSKY	248
Tracheldilatator, LABORDE	314	WAGNER, Supercutscchere	Wundhäkchen, BERGMANN	250
Tracheldilatator, TROUSSEAU	314	WALSHAM, Septumrichtzange	Wundhäkchen, FRAZIER	246
Trachelhaken, ITERSON	315	WALTER, Flachmeißel	Wundhäkchen, FREER	254
Transformator	26	Wangenhalter	Wundhäkchen, GILLIES	254
TROELTSCH,		Wangenhalter,	Wundhäkchen, GRAEFE	246
Nasentamponpinzette	149	CAWOOD-MINNESOTA	Wundhäkchen, GUTHRIE	246
TROELTSCH-WILDE,		Wangenhalter, STERNBERG	Wundhäkchen, HUMBY	248
Ohr-Nasen-Pinzette	94, 152	Warmlichtgriff	Wundhäkchen, JOSEPH	247
Trokar, COAKLEY	215	WATSON, Dermatome	Wundhäkchen,	
Trokar, LICHTWITZ	215	WATSON-WILLIAMS,	KLEINERT-KUTZ	247
Trokar, Sinoskopie	215	scharfe Nasenzange	Wundhäkchen, KNAPP	250
Trommelfellnadel, LUCAE	70	Watteträger	Wundhäkchen, LAHEY	246
Trommelfellnadel, POLITZER	70, 71	Watteträger, FARRELL	Wundhäkchen, LUCAE	66, 250
TROUSSEAU, Trachealdilatator	314	Watteträger, FEIN	Wundhäkchen, HADEO	249
TROUSSEAU-BABY,		Watteträger, FROHN	Wundhäkchen, ROLLET	250
Trachealdilatator	314	Watteträger, JOBSON-HORNE	Wundhäkchen, TYRELL	246
Tumorschere	207	Watteträger, KILLIAN	Wundhaken,	
Tupferzange, DUPLAY	295	Watteträger, HADEO	BRÜNNINGS-BRUNK	263
TYDING, Tonsillenschnürer	300	Watteträger, UCKERMANN	Wundhaken, HOFER	289
TYDING, Tonsillenzange	282	WEBER-LOCH, Ohrschlinge	Wundhaken,	
TYRELL, Wundhäkchen	246	WEBSTER, Nadelhalter	KOCHER-LANGENBECK	263
U		WEIL-BLAKESLEY,	Wundhaken, LOTHROP	288
UCKERMANN, Watteträger	64	Nasenzange	Wundhaken, LOVE	288
Uhrmacherpinzetten	96	WEITLANER, Wundspreizer	Wundhaken, MASING	251
Umstechungsnadel,		WEST, Septummeißel	Wundhaken, MIDDELDORPF	263
Laryngoskopie	353	WESTMACOTT,	Wundhaken, NAGER	289
UNIVERSAL,		Nasentamponzange	Wundhaken, ROUX-BABY	263
Draht- u. Bleischere	118, 299	WHITE, Tonsillenzange	Wundhaken, WILLIGER	114
UNIVERSAL, Pulverbläser	60	WIEDER, Zungendrucker	Wundsperrerr	110-113
Uvulahaken, LOTHROP	288	WIEN, Nasenspekula	Wundsperrerr, ADSON	112
Uvulahaken, LOVE	288	WIENER, Antrumraspel	Wundsperrerr, ALM	110
		WILDE (TROELTSCH),	Wundsperrerr, BOSE	314
		Ohr-Nasen-Pinzette	Wundsperrerr, FINSEN	110

Wundsperrerr, FISCH	112, 265	Zange, CRAIG-DOMINICK	158	Zungenspatel, DAVIS-BOYLE	273
Wundsperrerr, HOLZHEIMER	110	Zange, DENIS-BROWN	283	Zungenspatel, DOUGHTY	279
Wundsperrerr, JANSEN	110	Zange, FRAENKEL	342	Zungenspatel, FRENZEL	268
Wundsperrerr, MOLLISON	112	Zange, HARTMANN	154, 169, 307	Zungenspatel, Holz	268
Wundsperrerr, PLESTER	113, 264	Zange, HEYMANN	157	Zungenspatel, KROENIG	268
Wundsperrerr, WEITLANER	111	Zange, HOUSE-GELFOAM	85	Zungenspatel, McIVOR	277
Wundsperrerr, WULLSTEIN	113	Zange, JACKSON-CHEVALIER	356	Zungenspatel, RING	272
X		Zange, JANSEN-MIDDLETON	159	Zungenspatel, RUSSEI-DAVIS	278
Xenon-Stirnlampe	27	Zange, JATHO	310	Zungenzange, COLLIN	270
Y		Zange, JURASZ	311, 342	Zungenzange, YOUNG	270
YANKAUER, Saugrohr	284	Zange, KEYMANN-KNIGHT	156	Zystoskop	16
YANKAUER,		Zange, KNIGHT	157		
Tonsillenelevatorium	290	Zange, LAHEY	318		
YASARGIL,		Zange, LITTAUER	156		
Fixiervorrichtung	57, 148	Zange, LUBET-BARBON	154		
YASARGIL, flexibler Spannarm	57	Zange, LUC	157		
YASARGIL, Ohrspekulahalter	57	Zange, MARSCHIK	282		
YASARGIL, Ohrtrichterhalter	57	Zange, McINDOE	108, 208		
YOUNG, Zungenzange	270	Zange, MIDDLETON-JANSEN	159		
Z		Zange, NOYES	155		
Zängchen, BUCK	73	Zange, Ohr	131		
Zängchen, DUCKBILL	75	Zange, RUBIN	161		
Zängchen, GREVEN	81	Zange, Sinuskopie	178, 179		
Zängchen, HARTMANN	74, 75	Zange, St. CLAIR-THOMSON	310		
Zängchen,		Zange, STRUYCKEN	169		
HARTMANN-HOFFMANN	75, 175	Zange, THILENIUS	283		
Zängchen,		Zange, TYDING	282		
HARTMANN-WEINGÄRTNER	75	Zange, WALSHAM	160		
Zängchen,		Zange, WATSON-WILLIAMS	166		
HARTMANN-WULLSTEIN	75, 175	Zange, WEIL-BLAKESLEY	164, 168		
Zängchen, LITTAUER	74	Zange, WESTMACOTT	154		
Zängchen, McGEE	81	Zange, WHITE	281		
Zängchen, Mikro	75-81	Zange, YOUNG	270		
Zängchen, Ohr	76, 77	ZAUFAL, Ohrhebel	65		
Zängchen, SCHUHKNECHT	81	ZAUFAL-JANSEN,			
Zängchen, STRUEMPEL	75	Hohlmeißelzange	107		
Zängchen, TILLEY	74, 155	ZAUFAL-JANSEN, Ohrhebel	65		
Zängchen, WULLSTEIN	79	ZIEGLER, Stirnspiegel	23		
Zange, ABRAHAM	282	Zirkularstanze	186		
Zange, ASCH	160	ZÖLLNER, Saugrohr	125		
Zange, BALLENGER	281	Zugendrücker, ANDREW	269		
Zange, Biopsie	15, 167	Zugendrücker, DINGMANN	276		
Zange, BLAKESLEY	164, 168, 180	Zugendrücker, HARTMANN	269		
Zange, BLOHMKE	281	Zugendrücker,			
Zange, BRUENINGS	158	KILNER-DOUGHTY	275		
Zange, CHEVALIER-JACKSON	356	Zugendrücker,			
Zange, COLLIN	270	MORITZ-SCHMIDT	269		
Zange, COLVER	281	Zugendrücker, TOBOLD	270		
Zange, CRAIG	158	Zugendrücker, WIEDER	269		
		Zungenspatel	268		
		Zungenspatel, BRUENINGS	268		
		Zungenspatel, BUCHWALD	268		

- A**
- ABRAHAM forceps282
- ABRAHAM knife287
- adaptor for cable20
- adenoid BARNHILL308
- adenoid curette BECKMANN308
- adenoid curette
- St. CLAIR-THOMSON309
- adenotome LAFORCE309
- ADSON dressing forceps97
- ADSON tissue forceps97
- ADSON retractor111
- air bag POLITZER61
- alar retractor CONVERSE252
- alar retractor COTTLE252, 253
- alar retractor
- COTTLE-NEIVERT252
- alar retractor FOMON253
- alar retractor KILNER253
- ALDERDYCE tonsil dissector290
- ALM retractor109
- ANDREW tongue depressor269
- antrum curette COAKLEY256
- antrum curette FAULKNER256
- antrum elevator SEWALL226
- antrum punch184, 185
- antrum curette256, 257
- applicator cotton FARRELL63
- applicator cotton FROHN63
- applicator cotton
- JOBSON-HORNE64
- applicator cotton HADEO64
- applicator cotton UCKERMANN64
- ASCH septum straightening
forceps160
- AUFRICHT nasal rasp239
- AUFRICHT nasal retractor251
- B**
- BALLENGER septum elevator225
- BALLENGER tonsil forceps281
- BALLENGER
- septum swivel knife218
- BANE-HARTMANN
- bone rongeur106
- BARACANI tip354
- BARANY noise apparatus60
- BARBARA needle ROSEN ... 135, 136
- BARNHILL adenoid curette308
- BARON suction tube128
- BARRAQUER
- micro needle holder123
- BARSKY retractor248
- BARTH bone curette104
- BECKMANN adenoid curette308
- BELLUCCI micro ear scissors80
- bending device SCHUKNECHT ...85
- BERGMANN retractor250
- BEUSE face lift scissors201
- BEYER bone rongeur107
- BILLEAU ear loop65
- biopsy forceps15
- biopsy punch179
- bipolar suction forceps42
- bipolar forceps36, 37, 38
- bipolar cable39
- bipolar stitch electrode44, 45
- bipolar forceps NON STICK ...40, 41
- blades tongue DOUGHTY279
- blades tongue RUSSEL-DAVIS ...278
- blepharoplasty scissors
- GREENBERG-PAR202
- blepharoplasty scissors KAYE202
- BLOHMKE tonsil forceps281
- BLUMENTHAL bone rongeur106
- BOETTCHER tonsil scissors296
- BÖHLER bone rongeur107, 108
- BOIES nasal fracture elevator226
- bone rongeur
- BANE-HARTMANN106
- bone curette BARTH104
- bone rongeur BEYER107
- bone rongeur BLUMENTHAL106
- bone rongeur BÖHLER107, 108
- bone punch CITELLI109
- bone rongeur
- COTTLE-KAZANJIAN108
- bone curette DAUBENSPECK ...258
- bone punch
- FERRIS-SMITH-KERRISON181
- bone curette HALLE104, 258
- bone rongeur KLEINERT-KUTZ ...107
- bone curette LEMPERT103
- bone rongeur LEMPERT107
- bone rongeur LUER106
- bone curette MARTINI105
- bone rongeur MC INDOE108
- bone tamper PASSOW98, 235
- bone curette SPRATT103
- bone curette VOLKMANN104
- bone curette WILLIGER105
- bone rongeur ZAUFAL-JANSEN ..107
- bone curette JANSEN103
- bone cutting forceps
- COTTLE-KAZANJIAN208
- bone cutting forceps MC INDOE ..208
- BONN scissors192
- BOSE tracheal spreader314, 315
- BOUCHERON ear specula53
- BOWMAN lachrymal probe262
- BOWMAN salivary duct probe293
- bronchoscope forceps
- CHEVALIER-JACKSON356
- bronchoscope18
- BRUENINGS tongue depressor ...268
- BRUENINGS
- nasal septum forceps158
- BRUENINGS tonsil knife287
- BRUENINGS tonsil snare301
- BRUENINGS ear specula set55
- BRUENINGS handle354
- BRUENINGS tip354
- BRÜNINGS-BRUNK retractor263
- BRÜNINGS-LUCAS gouge98
- BUCHWALD tongue depressor ...268
- BUCK ear curette68, 69
- BUCK foreign body lever73
- burr30, 31
- C**
- cable bipolar39
- cable light guide19
- CANFIELD tonsil knife287
- cannula EICKEN212
- cannula KILLIAN212
- cannula laryngeal210, 306, 344
- cannula septum210, 306, 344
- cannula tracheal
- CHEVALIER-JACKSON316
- cannula tracheal LUER316
- CAPLAN nasal scissors206
- CARPENTER tonsil enucleator ...291
- carrier cotton FEIN347
- carrier cotton KILLIAN347
- carrier cotton347
- carrier fibreglass light337, 338
- cartilage crusher COTTLE237
- cartilage file DINGMANN130
- cartilage knife MASING219
- CASTROVIEJO
- micro needle holder124
- catheter ear HARTMANN70
- CAWOOD-MINNESOTA
- tongue depressor268
- cheek retractor STERNBERG270
- cheek retractor270

chest support LEWY.....	336	COTTLE-JOSEPH		DENIS BROWNE tonsil forceps ...	283
chest support NEGUS.....	280	septum elevator.....	224	depressor tongue ANDREW.....	269
CHEVALIER-JACKSON		COTTLE-KAZANJIAN		depressor tongue BRUENINGS...	268
tracheal cannula.....	316	bone cutting forceps.....	208	depressor tongue BUCHWALD ...	268
CHEVALIER-JACKSON		COTTLE-KAZANJIAN		depressor tongue	
bronchoscope forceps.....	356	bone rongeur.....	108	CAWOOD-MINNESOTA.....	268
chisel FREER.....	100	COTTLE-MASING		depressor tongue	
chisel PARTSCH.....	99	nasal scissors.....	198	DAVIS-BOYLE.....	273
chisel WALTER.....	235	COTTLE-NEIVERT		depressor tongue FRENZEL.....	268
chisel.....	98	alar retractor.....	252	depressor tongue HARTMANN ...	269
chisel rhinoplasty CINELLI.....	232	cotton applicator FARRELL.....	63	depressor tongue KROENIG.....	268
chisel rhinoplasty COTTLE.....	231	cotton carrier FEIN.....	347	depressor tongue	
chisel rhinoplasty FOMON.....	232	cotton applicator FROHN.....	63	MORITZ-SCHMIDT.....	269
chisel rhinoplasty		cotton applicator		depressor tongue RING.....	272
NEIVERT-ANDERSON.....	233	JOBSON-HORNE.....	64	depressor tongue TOBOLD.....	270
chisel rhinoplasty SHEEHAN.....	232	cotton carrier KILLIAN.....	347	depressor tongue WIEDER.....	269
chisel rhinoplasty SILVER.....	233	cotton applicator HADEO.....	64	depressor tongue.....	268
chisel septum FREER.....	230	cotton applicator UCKERMANN.....	64	DERF needle holder.....	209
choana hook LANGE.....	255	cotton carrier.....	347	DERLACKI tissue forceps.....	97
CINELLI rhinoplasty chisel.....	232	CRAIG nasal septum forceps.....	158	dermatome HUMBY.....	221
circular punch.....	186	CRAIG-DOMNICK		dermatome SCHINK.....	220
CITELLI bone punch.....	109	nasal septum forceps.....	158	dermatome SILVER.....	221
clamp muscular MASTIN.....	318	CRILE-WOOD needle holder.....	209	dermatome WATSON.....	221
CLAUS tonsil needle.....	285	crusher cartilage COTTLE.....	237	diagnostic set.....	48, 49, 50, 51, 52
coagulation suction tube.....	211	curette adenoid BARNHILL.....	308	DIETER malleus punch.....	84
coagulator monopolar suction.....	43	curette adenoid BECKMANN.....	308	dilator lachrimal WILDER.....	261
COAKLEY antrum curette.....	256	curette adenoid		dilator sinus RITTER-HALLE.....	261
COAKLEY trocar.....	215	St. CLAIR-THOMSON.....	309	dilator tracheal LABORDE.....	314
COLLIN tongue forceps.....	270	curette antrum COAKLEY.....	256	dilator tracheal TROUSSEAU.....	314
columella forceps COTTLE.....	153	curette antrum FAULKNER.....	256	dilator tracheal	
COLVER tonsil forceps.....	281	curette antrum.....	256, 257	TROUSSEAU-BABY.....	314
CONVERSE nasal knife.....	217	curette bone BARTH.....	104	DINGMANN cartilage file.....	130
CONVERSE alar retractor.....	252	curette bone DAUBENSPECK.....	258	DINGMANN mouth gag.....	276
CONVERSE scissors.....	194	curette bone HALLE.....	104, 258	DINGMANN nasal rasp.....	244
CORDES tip.....	354	curette bone LEMPERT.....	103	dissecting scissors GORNEY.....	116
COTTLE rhinoplasty chisel.....	231	curette bone MARTINI.....	105	dissecting scissors JAMESON.....	191
COTTLE cartilage crusher.....	237	curette bone SPRATT.....	103	dissecting scissors	
COTTLE septum elevator.....	224, 225	curette bone VOLKMANN.....	104	JOSEPH.....	116, 190
COTTLE columella forceps.....	153	curette bone WILLIGER.....	105	dissecting scissors KELLY.....	191
COTTLE ear forceps.....	94	curette bone JANSEN.....	103	dissecting scissors KILNER.....	191
COTTLE nasal forceps.....	152	curette ear BUCK.....	68, 69	dissecting scissors	
COTTLE nasal knife.....	217	curette micro HOUSE.....	133	METZENBAUM.....	115, 188, 189, 297
COTTLE nasal rasp.....	239			dissecting scissors	
COTTLE alar retractor.....	252, 253	D		METZENBAUM FINO.....	115, 189
COTTLE finger ring retractor.....	255	DAUBENSPECK bone curette.....	258	dissecting scissors RAGNELL.....	191
COTTLE nasal retractor.....	251	DAVIS-BOYLE		dissecting scissors REYNOLDS...	191
COTTLE nasal scissors.....	198	tongue depressor.....	273	dissecting scissors	
COTTLE nasal specula.....	146, 147	DAVIS-BOYLE mouth gag.....	274	SANVENERO.....	190
COTTLE mallet.....	102, 260	DAVIS-MEYER mouth gag.....	277	dissecting scissors	
COTTLE osteotome.....	100	DAY ear hook.....	66	STRABISMUS.....	116, 196
COTTLE retractor.....	254	DEAN tonsil scissors.....	296	dissector FISCH.....	93
COTTLE scissors.....	194	DENHART mouth gag.....	271	dissector thyroid KOCHER.....	317

dissector tonsil ALDERDYCE	290	HARTMANN-WULLSTEIN	175	F	
dissector tonsil HURD	290	ear polypus snare KRAUSE	72	face lift scissors BEUSE	201
dissector tonsil LOPEZ-REINKE ..	290	ear polypus snare WILDE	72	face lift scissors GORNEY	200
DOUGHTY tongue blades	279	ear specula holder YASARGIL	57	face lift scissors	
DOYEN-JANSEN mouth gag	271	ear specula set BRUENINGS	55	GORNEY-FREEMAN	200
dressing forceps ADSON	97	ear specula set SIEGLE	56	face lift scissors KAYE	201
dressing forceps DUPLAY	295	EICKEN cannula	212	face lift scissors	
dressing forceps GRAEFE	95	electrode bipolar stitch	44, 45	PECK-JOSEPH	201
dressing forceps POTTS-SMITH ..	294	electrodes	34, 35	FARABEUF raspatory	90
dressing forceps SEMKEN	95	elevator FREER	91	FARRELL cotton applicator	63
dressing forceps STANDARD	95	elevator LEMP PERT	88, 91	FARRIOR ear specula	54
dressing forceps	295	elevator MCKENTY	92	FAULKNER antrum curette	256
DUCKBILL micro ear forceps	75	elevator QUERVAIN	86	FEIN cotton carrier	347
DUPLAY dressing forceps	295	elevator SEBILEAU	86	FERGUSSON suction tube	213
DUPUY-WEISS tonsil needle	285	elevator	138	FERRIS-SMITH-KERRISON	
E		elevator antrum SEWALL	226	bone punch	181
ear specula BOUCHERON	53	elevator ear ZAUFAL-JANSEN	65	fibreglass light carrier	337, 338
ear curette BUCK	68, 69	elevator nasal FRONTAL	261	fibreglass laryngoscope	339
ear forceps COTTLE	94	elevator nasal SINUS	261	file cartilage DINGMANN	130
ear hook DAY	66	elevator nasal fracture BOIES	226	finger ring retractor COTTLE	255
ear specula GRUBER	53	elevator septum BALLENGER	225	FINSER retractor	109
ear specula HARTMANN	53	elevator septum COTTLE	224, 225	FISCH micro ear scissors	82
ear catheter HARTMANN	70	elevator septum		FISCH dissector	93
ear forceps HARTMANN	74	COTTLE-JOSEPH	224	FISCH retractor	111, 265
ear forceps LITTAUER	74	elevator septum FREER	223	FISHER tonsil knife	286
ear hook LUCAE	66	elevator septum		FOMON rhinoplasty chisel	232
ear forceps LUCAE	94	HAJEK-BALLENGER	225	FOMON nasal rasp	240, 241
ear syringe REINER	61	elevator septum HALLE	222	FOMON alar retractor	253
ear loop SHAPLEIGH	67	elevator septum HOWARTH	224	FOMON nasal scissors	198
ear probe STACKE	63	elevator septum JOSEPH	222	forceps biopsy	15
ear hook WAGENER	66	elevator septum KILLIAN	223, 225	forceps bipolar	36, 37, 38
ear forceps WILDE		elevator septum MASING	222	forceps bipolar NON STICK	40, 41
(TROELTSCH)	94	elevator septum MCKENTY ..	222, 224	forceps bone cutting	
ear loop ZAUFAL	65	elevator septum PENNINGTON ..	224	COTTLE-KAZANJIAN	208
ear elevator ZAUFAL-JANSEN	65	elevator septum PIERCE	223	forceps bone cutting MC INDOE ..	208
ear specula	55, 56	elevator septum ROGER	222	forceps bronchoscope	
ear syringe	62	elevator septum SINUS	223	CHEVALIER-JACKSON	356
ear loop BILLEAU	65	elevator septum fracture		forceps columella COTTLE	153
ear specula FARRIOR	54	GOLDMANN	226	forceps dressing ADSON	97
ear spoon GROSS	65	elevator tonsil HENKE	290	forceps dressing DUPLAY	295
ear loop LANGENBECK	65	elevator tonsil YANKAUER	290	forceps dressing GRAEFE	95
ear specula POLITZER	53	elevator laryngeal suction	352	forceps dressing POTTS-SMITH ..	294
ear forceps TILLEY	74	endoscope	18	forceps dressing SEMKEN	95
ear specula TOYNBEE	53	enucleator tonsil CARPENTER ..	291	forceps dressing STANDARD	95
ear loop WEBER-LOCH	67	epiglottis retractor REICHERT ..	343	forceps dressing	295
ear hook	65, 66	ethmoid forceps TAKAHASHI	165	forceps ear COTTLE	94
ear polypus forceps		ethmoid forceps		forceps ear HARTMANN	74
HARTMANN	175	WATSON-WILLIAMS	166	forceps ear LITTAUER	74
ear polypus forceps		ethmoid forceps		forceps ear LUCAE	94
HARTMANN-HOFFMANN	175	WEIL-BLAKESLEY	164	forceps ear WILDE	
ear polypus forceps		EVES tonsil snare	301	(TROELTSCH)	94
				forceps ear TILLEY	74

forceps ear polypus HARTMANN	175	(Sinus)	155	forceps tonsil WHITE	281
forceps ear polypus HARTMANN-HOFFMANN	175	forceps nasal dressing LUBET-BARBON	154	forceps tonsil abscess THILENIUS	283
forceps ear polypus HARTMANN-WULLSTEIN	175	forceps nasal dressing NOYES	155	forceps micro laryngeal	350, 351
forceps ethmoid TAKAHASHI	165	forceps nasal dressing TILLEY	155	forceps bipolar suction	42
forceps ethmoid WATSON-WILLIAMS	166	forceps nasal dressing WESTMACOTT	154	foreign body lever BUCK	73
forceps ethmoid WEIL-BLAKESLEY	164	forceps nasal polypus HEYMANN-KNIGHT	156	foreign body lever QUIRE	73
forceps jeweler	96	forceps nasal polypus LITTAUER	156	fork tuning HARTMANN	58
forceps laryngeal JACKSON	343	forceps nasal polypus BRUENINGS	158	fork tuning LUCAE	59
forceps laryngeal polypus FRAENKEL	342	forceps nasal septum CRAIG	158	fork tuning RYDEL-SEIFFERT	59
forceps laryngeal polypus JURASZ	342	forceps nasal septum CRAIG-DOMNICK	158	fork tuning	58, 59
forceps maxillary sinus	176, 177	forceps nasal septum HEYMANN	157	FRAENKEL	
forceps micro ear DUCKBILL	75	forceps nasal septum KNIGHT	157	laryngeal polypus forceps	342
forceps micro ear HARTMANN	75	forceps nasal septum LUC	157	FRAENKEL tip	354
forceps micro ear HARTMANN-HOFFMANN	75	forceps nasal septum MIDDLETON-JANSEN	159	FRAZIER retractor	246
forceps micro ear HARTMANN-WEINGÄRTNER	75	forceps naso pharyngeal JATHO	310	FRAZIER/FERGUSSON	
forceps micro ear HARTMANN-WULLSTEIN	75	forceps naso pharyngeal JURASZ	311	suction tube	125, 213
forceps micro ear ...75, 76, 77, 78, 79		forceps naso pharyngeal St. CLAIR-THOMSON	310	FREER septum chisel	230
forceps morselizer RUBIN	161	forceps pressure HOUSE-GELFOAM	85	FREER septum elevator	223
forceps nasal COTTLE	152	forceps seizing LAHEY	318	FREER nasal knife	216
forceps nasal GILLIES	151	forceps septum straightening ASCH	160	FREER chisel	100
forceps nasal GRAEFE	151	forceps septum straightening WALSHAM	160	FREER elevator	91
forceps nasal JANSEN	150	forceps tissue ADSON	97	FREER gouge	236
forceps nasal JANSEN-GRUENWALD	150	forceps tissue DERLACKI	97	FREER retractor	254
forceps nasal LUCAE	152	forceps tissue POTTS-SMITH	294	FREER-INGALS mucosa knife	219
forceps nasal McINDOE	151	forceps tissue SEMKEN	95	FRENZEL nystagmus spectacle	22
forceps nasal TROELTSCH	149	forceps tongue YOUNG	270	FRENZEL tongue depressor	268
forceps nasal WILDE (TROELTSCH)	152	forceps tongue COLLIN	270	FROHN cotton applicator	63
forceps nasal	167, 180	forceps tonsil ABRAHAM	282	FRONTAL nasal elevator	261
forceps nasal cutting HARTMANN	169	forceps tonsil BALLENGER	281		
forceps nasal cutting SCHMEDEN	169	forceps tonsil BLOHMKE	281	G	
forceps nasal cutting STRUYCKEN	169	forceps tonsil COLVER	281	gag mouth DAVIS-BOYLE	274
forceps nasal cutting WEIL-BLAKESLEY	168	forceps tonsil DENIS BROWNE	283	gag mouth DAVIS-MEYER	277
forceps nasal cutting	170-174, 178	forceps tonsil MARSCHIK	282	gag mouth DENHART	271
forceps nasal dressing HARTMANN	154	forceps tonsil MIKULICZ	283	gag mouth DINGMANN	276
forceps nasal dressing LISTER		forceps tonsil NEGUS	281	gag mouth DOYEN-JANSEN	271
		forceps tonsil SAWTELL	281	gag mouth HEISTER	271
		forceps tonsil SCHNIDT	281	gag mouth JENNINGS	271
		forceps tonsil TYDING	282	gag mouth KILNER-DOUGHTY	275
				gag mouth MAUNDER	280
				gag mouth McIVOR	277
				gag mouth MOLT	271
				gag mouth ROSER-KOENIG	271
				GALLAHER nasal rasp	243
				gauze packer LUNIATSCHEK	292
				GERZOG mallet	259
				GILLIES nasal forceps	151
				GILLIES retractor	254
				GLABELLA nasal rasp	238
				GOLDMANN	
				septum fracture elevator	226
				GOOD tonsil scissors	296

- GORNEY dissecting scissors..... 116
 GORNEY face lift scissors.....200
 GORNEY-FREEMAN
 face lift scissors.....200
 gouge BRÜNINGS-LUCAS98
 gouge FREER236
 gouge LEXER MINI100
 gouge PARTSCH.....99
 gouge WEST236
 gouge98
 gouge rhinoplasty HAJEK.....236
 gouge rhinoplasty
 KILLIAN-CLAUS236
 GRADLE scissors195
 GRAEFE dressing forceps95
 GRAEFE nasal forceps151
 GRAEFE retractor246
 GRAEFE scissors194
 GREENBERG-PAR
 blepharoplasty scissors202
 GREVEN micro ear scissors81
 GROSS ear spoon.....65
 GRUBER ear specula.....53
 GUILÉN raspatory suction.....227
 GUTHRIE retractor246
- H**
 HAJEK rhinoplasty gouge.....236
 HAJEK mallet102
 HAJEK-BALLENGER
 septum elevator.....225
 HAJEK-KOFLER punch182, 183
 HALLE bone curette104, 258
 HALLE septum elevator.....222
 HALSEY needle holder209
 handle BRUENINGS354
 handle HUBER354
 handle laryngeal346
 handle laryngoscope332, 333
 handle suction WULLSTEIN.....129
 HARTMANN ear catheter70
 HARTMANN tongue depressor ...269
 HARTMANN ear forceps74
 HARTMANN
 ear polypus forceps175
 HARTMANN micro ear forceps75
 HARTMANN
 nasal cutting forceps.....169
 HARTMANN
 nasal dressing forceps.....154
 HARTMANN tuning fork58
 HARTMANN tonsil punch.....307
- HARTMANN ear specula.....53
 HARTMANN nasal specula142
 HARTMANN-HALLE
 nasal specula.....141
 HARTMANN-HOFFMANN
 ear polypus forceps175
 HARTMANN-HOFFMANN
 micro ear forceps.....75
 HARTMANN-WEINGÄRTNER
 micro ear forceps.....75
 HARTMANN-WULLSTEIN
 ear polypus forceps175
 HARTMANN-WULLSTEIN
 micro ear forceps.....75
 head mirror ZIEGLER.....23
 head light24, 25, 26, 27
 HEISTER mouth gag271
 HENKE tonsil elevator290
 HEYMANN
 nasal septum forceps157
 HEYMANN nasal scissors198
 HEYMANN-KNIGHT
 nasal polypus forceps156
 HOFER palate retractor289
 HOLZHEIMER retractor109
 hook PLESTER137
 hook choana LANGE255
 hook ear DAY66
 hook ear LUCAE.....66
 hook ear WAGENER66
 hook ear65, 66
 hook laryngeal352, 353
 hook tracheal ITERSON315
 hook tracheal JACKSON314
 hook tracheal NEWS315
 hooklet McGEE.....136
 HOUSE micro curette.....133
 HOUSE measuring rod.....132
 HOUSE suction tube126, 214
 HOUSE-GELFOAM
 pressure forceps.....85
 HOWARTH septum elevator.....224
 HUBER handle354
 HUMBY dermatome221
 HUMBY retractor248
 HURD tonsil dissector290
- I**
 injection needle349
 instrument handle laryngeal353
 IRIS operating scissors.....117, 192
 ITERSON tracheal hook.....315
- J**
 JACKSON laryngeal forceps343
 JACKSON tracheal hook314
 JAMESON dissecting scissors191
 JANSEN bone curette103
 JANSEN nasal forceps.....150
 JANSEN raspatory91
 JANSEN retractor109
 JANSEN-GRUENWALD
 nasal forceps150
 JATHO naso pharyngeal forceps.310
 JENNINGS mouth gag271
 jeweler forceps96
 JOBSON-HORNE cotton
 applicator64
 JOSEPH septum elevator.....222
 JOSEPH nasal knife.....216, 217
 JOSEPH nasal rasp.....238, 239
 JOSEPH nasal saw244, 245
 JOSEPH
 dissecting scissors.....116, 190
 JOSEPH raspatory88
 JOSEPH retractor247
 JURASZ
 laryngeal polypus forceps.....342
 JURASZ
 naso pharyngeal forceps311
- K**
 KABIERSKE powder blower60
 KAYE blepharoplasty scissors.....202
 KAYE face lift scissors.....201
 KELLY dissecting scissors.....191
 KERRISON punch109, 182
 KILLIAN cotton carrier347
 KILLIAN septum elevator.....223, 225
 KILLIAN laryngeal scissors.....343
 KILLIAN nasal specula144, 145
 KILLIAN cannula212
 KILLIAN-CLAUS
 rhinoplasty gouge236
 KILNER alar retractor253
 KILNER dissecting scissors.....191
 KILNER-DOUGHTY mouth gag ...275
 KLEINERT-KUTZ bone rongeur...107
 KLEINERT-KUTZ retractor247
 KNAPP retractor250
 KNAPP scissors193
 knife PLESTER.....122
 knife ROSEN.....120, 121
 knife SCHUKNECHT122
 knife TABB.....122

knife WULLSTEIN	122	laryngeal handle	346	LOTHROP uvula retractor	288
knife	121	laryngeal knife	352, 353	LOVE uvula retractor	288
knife cartilage MASING	219	laryngeal hook	352, 353	LUBET-BARBON	
knife laryngeal	352, 353	laryngeal needle	352	nasal dressing forceps.....	154
knife mucosa FREER-INGALS.....	219	laryngeal instrument handle	353	LUC nasal septum forceps	157
knife nasal CONVERSE	217	laryngeal micro forceps	350, 351	LUCAE ear forceps.....	94
knife nasal COTTLE	217	laryngeal polypus snare.....	319	LUCAE nasal forceps	152
knife nasal FREER	216	laryngeal needle holder	349	LUCAE tuning fork.....	59
knife nasal JOSEPH.....	216, 217	laryngeal polypus forceps		LUCAE ear hook.....	66
knife septum swivel		FRAENKEL.....	342	LUCAE tympanum knife	70
BALLENGER.....	218	laryngeal polypus forceps		LUCAE retractor	250
knife sickle HADEO.....	217	JURASZ.....	342	LUER tracheal cannula.....	316
knife tonsil ABRAHAM.....	287	laryngoscope McCOY.....	324, 331	LUER bone rongeur.....	106
knife tonsil BRUENINGS	287	laryngoscope McINTOSH		LUNIATSCHEK gauze packer	292
knife tonsil CANFIELD.....	287	322, 323, 327, 328		
knife tonsil FISHER	286	laryngoscope MILLER		M	
knife tympanum LUCAE	70	325, 326, 329, 330	mallet COTTLE.....	102, 260
knife tympanum POLITZER.....	70, 71	laryngoscope	17	mallet GERZOG	259
knife tympanum SEXTON	71	laryngoscope handle	332, 333	mallet HAJEK	102
KNIGHT nasal septum forceps.....	157	laryngoscope spare bulb	332, 333	mallet MEAD.....	102, 259
knot tier NEGUS.....	304	laryngoscope fibreglass	339	mallet PARTSCH	102, 260
knot laryngeal tier	352	laryngoscope operation		mallet QUISLING.....	260
KOCHER thyroid dissector.....	317	334, 335, 340, 341	mallet	102, 259
KOCHER-LANGENBECK		LEMPERT bone curette.....	103	mallet plastic	260
retractor	263	LEMPERT bone rongeur	107	malleus punch DIETER	84
KÖNIG raspatory	86	LEMPERT elevator	88, 91	MALTZ nasal rasp	238, 239
KRAUSE ear polypus snare	72	LEMPERT raspatory	88	MARSCHIK tonsil forceps	282
KRAUSE nasal polypus snare.....	162	lever foreign body BUCK.....	73	MARTINI bone curette.....	105
KRAUSE tip	354	lever foreign body QUIRE.....	73	MASING septum elevator.....	222
KRAUSE-VOSS		LEWIS nasal rasp.....	239	MASING cartilage knife	219
nasal polypus snare.....	162	LEWY chest support	336	MASING nasal rasp.....	242
KROENIG tongue depressor	268	LEXER osteotome	228	MASING nasal retractor	251
		LEXER MINI gouge	100	MASING-NEIVERT	
L		LEXER MINI osteotome	100	nasal retractor.....	251
LABORDE tracheal dilator.....	314	LEYLA retractor	148	MASTIN muscular clamp.....	318
lachrymal probe BOWMAN	262	LICHTWITZ trocar	215	MAUNDER mouth gag	280
lachrymal dilator WILDER	261	light fibreglass carrier	337, 338	maxillary sinus forceps	176, 177
LAFORCE adenotome	309	light guide cable	19	MC INDOE	
LAHEY seizing forceps.....	318	LINDEMANN nasal saw	245	bone cutting forceps	208
LAHEY retractor	246	LISTER (Sinus)		MC INDOE bone rongeur	108
LANGE choana hook.....	255	nasal dressing forceps.....	155	McCOY laryngoscope	324, 331
LANGE tip	354	LITTAUER ear forceps	74	McGEE hooklet	136
LANGENBECK ear loop.....	65	LITTAUER		McGHEE micro ear scissors.....	81
LANGENBECK raspatory	86	nasal polypus forceps.....	156	McINDOE nasal forceps.....	151
larangeal micro scissors	351	LITTAUER stitch scissors	199	McINTOSH laryngoscope	
laryngeal suction elevator.....	352	LITTLER scissors	194	322, 323, 327, 328
laryngeal forceps JACKSON	343	loop ear SHAPLEIGH.....	67	McIVOR mouth gag.....	277
laryngeal scissors KILLIAN.....	343	loop ear ZAUFAL.....	65	McKENTY septum elevator	222, 224
laryngeal mirror MICHEL	345	loop ear BILLEAU.....	65	McKENTY elevator	92
laryngeal knot tier	352	loop ear LANGENBECK.....	65	MEAD mallet	102, 259
laryngeal cannula	210, 306, 344	loop ear WEBER-LOCH.....	67	measuring rod HOUSE.....	132
laryngeal mirror	346	LOPEZ-REINKE tonsil dissector	290		

- METZENBAUM dissecting scissors 115, 188, 189, 297
METZENBAUM FINO
 dissecting scissors 115, 189
MICHEL laryngeal mirror 345
 micro needle holder
BARRAQUER 123
 micro needle holder
CASTROVIEJO 124
 micro laryngeal forceps 350, 351
 micro curette **HOUSE** 133
 micro larangeal scissors 351
 micro scissors 119, 131, 203-205
 micro ear scissors **BELLUCCI** 80
 micro ear forceps **DUCKBILL** 75
 micro ear scissors **FISCH** 82
 micro ear scissors **GREVEN** 81
 micro ear forceps **HARTMANN** 75
 micro ear forceps
HARTMANN-HOFFMANN 75
 micro ear forceps
HARTMANN-WEINGÄRTNER 75
 micro ear forceps
HARTMANN-WULLSTEIN 75
 micro ear scissors **McGHEE** 81
 micro ear scissors
SCHUKNECHT 81
 micro ear scissors **SHEA** 80
 micro ear scissors **WULLSTEIN** 83
 micro ear forceps ... 75, 76, 77, 78, 79
MIDDELDORPF retractor 263
MIDDLETON-JANSEN
 nasal septum forceps 159
MIKULICZ tonsil forceps 283
MILLER laryngoscope
 325, 326, 329, 330
MILLER raspatory 92
MINI-LAMBOTTE osteotome
 99, 229
 mirror head **ZIEGLER** 23
 mirror laryngeal **MICHEL** 345
 mirror laryngeal 346
MOLLISON retractor 111
MOLT mouth gag 271
MOLT raspatory 92
 monopolar suction coagulator 43
MORITZ-SCHMIDT
 tongue depressor 269
 morselizer forceps **RUBIN** 161
 mouth gag **DAVIS-BOYLE** 274
 mouth gag **DAVIS-MEYER** 277
 mouth gag **DENHART** 271
 mouth gag **DINGMANN** 276
 mouth gag **DOYEN-JANSEN** 271
 mouth gag **HEISTER** 271
 mouth gag **JENNINGS** 271
 mouth gag **KILNER-DOUGHTY** 275
 mouth gag **MAUNDER** 280
 mouth gag **McIVOR** 277
 mouth gag **MOLT** 271
 mouth gag **ROSER-KOENIG** 271
 mucosa knife **FREER-INGALS** 219
 muscular clamp **MASTIN** 318
- N**
NAGER tonsil needle 286
NAGER palate retractor 289
 nasal rasp **AUFRICHT** 239
 nasal retractor **AUFRICHT** 251
 nasal scissors **CAPLAN** 206
 nasal knife **CONVERSE** 217
 nasal specula **COTTLE** 146, 147
 nasal forceps **COTTLE** 152
 nasal scissors **COTTLE** 198
 nasal knife **COTTLE** 217
 nasal rasp **COTTLE** 239
 nasal retractor **COTTLE** 251
 nasal scissors
COTTLE-MASING 198
 nasal rasp **DINGMANN** 244
 nasal scissors **FOMON** 198
 nasal rasp **FOMON** 240, 241
 nasal knife **FREER** 216
 nasal elevator **FRONTAL** 261
 nasal rasp **GALLAHER** 243
 nasal forceps **GILLIES** 151
 nasal rasp **GLABELLA** 238
 nasal forceps **GRAEFE** 151
 nasal specula **HARTMANN** 142
 nasal specula
HARTMANN-HALLE 141
 nasal scissors **HEYMANN** 198
 nasal forceps **JANSEN** 150
 nasal forceps
JANSEN-GRUENWALD 150
 nasal knife **JOSEPH** 216, 217
 nasal rasp **JOSEPH** 238, 239
 nasal saw **JOSEPH** 244, 245
 nasal specula **KILLIAN** 144, 145
 nasal rasp **LEWIS** 239
 nasal saw **LINDEMANN** 245
 nasal forceps **LUCAE** 152
 nasal rasp **MALTZ** 238, 239
 nasal rasp **MASING** 242
 nasal retractor **MASING** 251
 nasal retractor
MASING-NEIVERT 251
 nasal forceps **McINDOE** 151
 nasal rasp **PARKES** 238
 nasal rasp **PEET** 238
 nasal specula **HADEO** 144
 nasal elevator **SINUS** 261
 nasal specula **THUDICHUM** 140
 nasal specula **TIECK-HALLE** 144
 nasal forceps **TROELTSCH** 149
 nasal specula **VOLTOLINI** 140
 nasal specula **WIEN** 143
 nasal rasp **WIENER** 238
 nasal forceps **WILDE**
 (**TROELTSCH**) 152
 nasal forceps 167, 180
 nasal scissors 187
 nasal cutting forceps
HARTMANN 169
 nasal cutting forceps
SCHMEDEN 169
 nasal cutting forceps
STRUYCKEN 169
 nasal cutting forceps
WEIL-BLAKESLEY 168
 nasal cutting forceps 170-174, 178
 nasal dressing forceps
HARTMANN 154
 nasal dressing forceps
LISTER (**Sinus**) 155
 nasal dressing forceps
LUBET-BARBON 154
 nasal dressing forceps **NOYES** 155
 nasal dressing forceps **TILLEY** 155
 nasal dressing forceps
WESTMACOTT 154
 nasal fracture elevator **BOIES** 226
 nasal polypus forceps
HEYMANN-KNIGHT 156
 nasal polypus snare **KRAUSE** 162
 nasal polypus snare
KRAUSE-VOSS 162
 nasal polypus forceps
LITTAUER 156
 nasal polypus snare **WILDE** 163
 nasal septum forceps
BRUENINGS 158
 nasal septum forceps **CRAIG** 158
 nasal septum forceps
CRAIG-DOMNICK 158
 nasal septum forceps **HEYMANN** .. 157

- nasal septum forceps KNIGHT 157
 nasal septum forceps LUC 157
 nasal septum forceps
 MIDDLETON-JANSEN 159
 naso pharyngeal forceps JATHO..310
 naso pharyngeal forceps
 JURASZ..... 311
 naso pharyngeal forceps
 St. CLAIR-THOMSON310
 nasalaryngoscope 14
 needle BARBARA ROSEN ... 135, 136
 needle SHAMBOUGH 135
 needle injection 349
 needle laryngeal 352
 needle tonsil CLAUS 285
 needle tonsil DUPUY-WEISS 285
 needle tonsil NAGER..... 286
 needle tonsil 210, 306, 344
 needle holder CRILE-WOOD 209
 needle holder DERF 209
 needle holder HALSEY..... 209
 needle holder WEBSTER..... 209
 needle holder
 WEBSTER-BABY 209
 needle holder laryngeal 349
 needle holder micro
 BARRAQUER..... 123
 needle holder micro
 CASTROVIEJO 124
 NEGUS tonsil forceps..... 281
 NEGUS knot tier 304
 NEGUS chest support 280
 NEIVERT-ANDERSON
 rhinoplasty chisel 233
 NEWS tracheal hook 315
 noise apparatus BARANY 60
 NON STICK bipolar forceps 40, 41
 NOYES nasal dressing forceps 155
 nystagmus spectacle FRENZEL 22
- O**
 O BRIEN stitch scissors 199
 OBWEGESER osteotome 234
 operating scissors IRIS..... 117, 192
 operating scissors STANDARD 117
 operation laryngoscope
 334, 335, 340, 341
 osteotome COTTLE..... 100
 osteotome LEXER 228
 osteotome LEXER MINI 100
 osteotome MINI-LAMBOTTE
 99, 229
- osteotome OBWEGESER 234
 osteotome RUBIN..... 234
 osteotome WEST 236
 osteotome 98
 osteotome septum SHEEHAN..... 101
 otoscope 17
- P**
 palate retractor HOFER..... 289
 palate retractor NAGER..... 289
 PARKES nasal rasp..... 238
 PARTSCH chisel 99
 PARTSCH gouge 99
 PARTSCH mallet 102, 260
 PASSOW bone tamper..... 98, 235
 PECK-JOSEPH face lift scissors.. 201
 PEET nasal rasp..... 238
 PENNINGTON septum elevator ... 224
 PERWITZSCHKY
 salival scissors..... 298
 pharyngoscope 16
 PIERCE septum elevator 223
 plastic mallet 260
 PLESTER suction tube 126
 PLESTER hook 137
 PLESTER knife 122
 PLESTER retractor 112, 264
 POLITZER tympanum knife..... 70, 71
 POLITZER ear specula 53
 POLITZER air bag 61
 polypus laryngeal snare..... 319
 POTTS-SMITH dressing forceps.. 294
 POTTS-SMITH tissue forceps..... 294
 powder blower KABIERSKA..... 60
 powder blower UNIVERSAL..... 60
 pressure forceps
 HOUSE-GELFOAM 85
 PRINCE tonsil scissors..... 296
 probe ear STACKE 63
 probe lachrymal BOWMAN 262
 probe salivary duct BOWMAN..... 293
 punch HAJEK-KOFLER..... 182, 183
 punch KERRISON 109, 182
 punch antrum 184, 185
 punch biopsy 179
 punch bone CITELLI..... 109
 punch bone
 FERRIS-SMITH-KERRISON 181
 punch circular 186
 punch malleus DIETER 84
 punch tonsil HARTMANN 307
- Q**
 QUERVAIN elevator 86
 QUIRE foreign body lever..... 73
 QUISLING mallet 260
- R**
 RAGNELL dissecting scissors..... 191
 rasp nasal AUFRICHT 239
 rasp nasal COTTLE..... 239
 rasp nasal DINGMANN 244
 rasp nasal FOMON 240, 241
 rasp nasal GALLAHER..... 243
 rasp nasal LABELLA..... 238
 rasp nasal JOSEPH..... 238, 239
 rasp nasal LEWIS..... 239
 rasp nasal MALTZ 238, 239
 rasp nasal MASING..... 242
 rasp nasal PARKES..... 238
 rasp nasal PEET..... 238
 rasp nasal WIENER..... 238
 raspatory FARABEUF..... 90
 raspatory suction GUILLEN..... 227
 raspatory JANSEN 91
 raspatory JOSEPH 88
 raspatory KÖNIG 86
 raspatory LANGENBECK..... 86
 raspatory LEMPERT..... 88
 raspatory MILLER..... 92
 raspatory MOLT..... 92
 raspatory ROSEN..... 93
 raspatory WILLIGER 87
 raspatory WULLSTEIN..... 92
 raspatory 86-93, 138, 227
 HADEO cotton applicator..... 64
 HADEO sickle knife 217
 HADEO nasal specula 144
 HADEO retractor..... 249
 REICHERT epiglottis retractor..... 343
 REINER ear syringe 61
 retractor ADSON..... 111
 retractor ALM 109
 retractor BARSKY..... 248
 retractor BERGMANN 250
 retractor BRÜNNINGS-BRUNK 263
 retractor COTTLE..... 254
 retractor FINSSEN 109
 retractor FISCH 111, 265
 retractor FRAZIER 246
 retractor FREER..... 254
 retractor GILLIES..... 254
 retractor GRAEFE 246
 retractor GUTHRIE 246

- retractor HOLZHEIMER.....109
 retractor HUMBY.....248
 retractor JANSEN.....109
 retractor JOSEPH.....247
 retractor KLEINERT-KUTZ.....247
 retractor KNAPP.....250
 retractor
 KOCHER-LANGENBECK.....263
 retractor LAHEY.....246
 retractor LEYLA.....148
 retractor LUCAE.....250
 retractor MIDDELDORPF.....263
 retractor MOLLISON.....111
 retractor PLESTER.....112, 264
 retractor HADEO.....249
 retractor ROLLET.....250
 retractor ROUX-BABY.....263
 retractor WEITLANER.....110
 retractor
 WEITLANER-WULLSTEIN.....110
 retractor WILLIGER.....113
 retractor WULLSTEIN.....112
 retractor alar CONVERSE.....252
 retractor alar COTTLE.....252, 253
 retractor alar
 COTTLE-NEIVERT.....252
 retractor alar FOMON.....253
 retractor alar KILNER.....253
 retractor cheek STERNBERG.....270
 retractor cheek.....270
 retractor epiglottis REICHERT.....343
 retractor finger ring COTTLE.....255
 retractor nasal AUFRICHT.....251
 retractor nasal COTTLE.....251
 retractor nasal MASING.....251
 retractor nasal
 MASING-NEIVERT.....251
 retractor palate HOFER.....289
 retractor palate NAGER.....289
 retractor thyroid SCHOENBORN.....317
 retractor uvula LOTHROP.....288
 retractor uvula LOVE.....288
 REYNOLDS dissecting scissors...191
 rhinoplasty chisel CINELLI.....232
 rhinoplasty chisel COTTLE.....231
 rhinoplasty chisel FOMON.....232
 rhinoplasty gouge HAJEK.....236
 rhinoplasty gouge
 KILLIAN-CLAUS.....236
 rhinoplasty chisel
 NEIVERT-ANDERSO.....233
 rhinoplasty chisel SHEEHAN.....232
 rhinoplasty chisel SILVER.....233
 RING tongue depressor.....272
 RITTER-HALLE sinus dilator.....261
 rod measuring HOUSE.....132
 ROEDER "E" tonsil snare.....303
 ROGER septum elevator.....222
 ROLLET retractor.....250
 rongeur bone
 BANE-HARTMANN.....106
 rongeur bone BEYER.....107
 rongeur bone BLUMENTHAL.....106
 rongeur bone BÖHLER.....107, 108
 rongeur bone
 COTTLE-KAZANJIAN.....108
 rongeur bone KLEINERT-KUTZ...107
 rongeur bone LEMPERT.....107
 rongeur bone LUER.....106
 rongeur bone MC INDOE.....108
 rongeur bone ZAUFAL-JANSEN..107
 ROSEN needle BARBARA...135, 136
 ROSEN suction tube.....129
 ROSEN knife.....120, 121
 ROSEN raspatory.....93
 ROSER-KOENIG mouth gag.....271
 ROUX-BABY retractor.....263
 RUBIN morselizer forceps.....161
 RUBIN osteotome.....234
 RUSSEL-DAVIS tongue blades...278
 RYDEL-SEIFFERT tuning fork.....59
- S**
 salival scissors
 PERWITZSCHKY.....298
 salivary duct probe BOWMAN.....293
 SANVENERO
 dissecting scissors.....190
 saw nasal JOSEPH.....244, 245
 saw nasal LINDEMANN.....245
 SAWTELL tonsil forceps.....281
 SCHEINMANN tip.....354
 SCHINK dermatome.....220
 SCHMEDEN
 nasal cutting forceps.....169
 SCHNIDT tonsil forceps.....281
 SCHOENBORN
 thyroid retractor.....317
 SCHUKNECHT
 micro ear scissors.....81
 SCHUKNECHT bending device...85
 SCHUKNECHT knife.....122
 SCHUMACHER tip.....354
 scissors BONN.....192
 scissors CONVERSE.....194
 scissors COTTLE.....194
 scissors GRADLE.....195
 scissors GRAEFE.....194
 scissors KNAPP.....193
 scissors LITTLER.....194
 scissors STEVENS.....196
 scissors WAGNER.....197
 scissors WALTER.....194
 scissors WILMER.....194
 scissors blepharoplasty
 GREENBERG-PAR.....202
 scissors blepharoplasty KAYE.....202
 scissors dissecting GORNEY.....116
 scissors dissecting JAMESON.....191
 scissors dissecting
 JOSEPH.....116, 190
 scissors dissecting KELLY.....191
 scissors dissecting KILNER.....191
 scissors dissecting
 METZENBAUM....115, 188, 189, 297
 scissors dissecting
 METZENBAUM FINO.....115, 189
 scissors dissecting RAGNELL.....191
 scissors dissecting REYNOLDS...191
 scissors dissecting
 SANVENERO.....190
 scissors dissecting
 STRABISMUS.....116, 196
 scissors face lift BEUSE.....201
 scissors face lift GORNEY.....200
 scissors face lift
 GORNEY-FREEMAN.....200
 scissors face lift KAYE.....201
 scissors face lift PECK-JOSEPH..201
 scissors laryngeal KILLIAN.....343
 scissors micro.....119, 131, 203-205
 scissors micro ear BELLUCCI.....80
 scissors micro ear FISCH.....82
 scissors micro ear GREVEN.....81
 scissors micro ear MCGHEE.....81
 scissors micro ear SCHUKNECHT..81
 scissors micro ear SHEA.....80
 scissors micro ear WULLSTEIN....83
 scissors nasal CAPLAN.....206
 scissors nasal COTTLE.....198
 scissors nasal COTTLE-MASING 198
 scissors nasal FOMON.....198
 scissors nasal HEYMANN.....198
 scissors nasal.....187
 scissors operating IRIS.....117, 192
 scissors operating STANDARD....117

- scissors salival
PERWITZSCHKY 298
- scissors stich LITTAUER 199
- scissors stich O BRIEN 199
- scissors stich SPENCER 199
- scissors tonsil BOETTCHER 296
- scissors tonsil DEAN 296
- scissors tonsil GOOD 296
- scissors tonsil PRINCE 296
- scissors tumor 207
- scissors wire UNIVERSAL 118, 299
- scissors micro larangeal 351
- SEBILEAU elevator 86
- SEIFERT tip 354
- seizing forceps LAHEY 318
- SEMKEN dressing forceps 95
- SEMKEN tissue forceps 95
- septum elevator BALLENGER 225
- septum elevator COTTLE 224, 225
- septum elevator
COTTLE-JOSEPH 224
- septum elevator FREER 223
- septum chisel FREER 230
- septum elevator
HAJEK-BALLENGER 225
- septum elevator HALLE 222
- septum elevator HOWARTH 224
- septum elevator JOSEPH 222
- septum elevator KILLIAN 223, 225
- septum elevator MASING 222
- septum elevator McKENTY 222, 224
- septum elevator PENNINGTON 224
- septum elevator PIERCE 223
- septum elevator ROGER 222
- septum osteotome SHEEHAN 101
- septum elevator SINUS 223
- septum cannula 210, 306, 344
- septum fracture elevator
GOLDMANN 226
- septum straightening forceps
ASCH 160
- septum straightening forceps
WALSHAM 160
- septum swivel knife
BALLENGER 218
- SEWALL antrum elevator 226
- SEXTON tympanum knife 71
- SHAMBOUGH needle 135
- SHAPLEIGH ear loop 67
- SHEA micro ear scissors 80
- SHEA spoon 134
- SHEEHAN rhinoplasty chisel 232
- SHEEHAN septum osteotome 101
- sickle knife HADEO 217
- SIEGLE ear specula set 56
- SILVER rhinoplasty chisel 233
- SILVER dermatome 221
- sinus dilator RITTER-HALLE 261
- SINUS nasal elevator 261
- SINUS septum elevator 223
- sinuscope 15
- sinuscopy trocar UNIVERSAL 214
- SLUDER-BALLENGER
tonsillectome 305
- snare ear polypus KRAUSE 72
- snare ear polypus WILDE 72
- snare nasal polypus KRAUSE 162
- snare nasal polypus
KRAUSE-VOSS 162
- snare nasal polypus WILDE 163
- snare tonsil BRUENINGS 301
- snare tonsil EVES 301
- snare tonsil ROEDER "E" 303
- snare tonsil TYDING 300
- snare laryngeal polypus 319
- spare bulb 22
- spare bulb laryngoscope 332, 333
- specula ear BOUCHERON 53
- specula ear GRUBER 53
- specula ear HARTMANN 53
- specula ear 55, 56
- specula ear FARRIOR 54
- specula ear POLITZER 53
- specula ear TOYNBEE 53
- specula nasal COTTLE 146, 147
- specula nasal HARTMANN 142
- specula nasal
HARTMANN-HALLE 141
- specula nasal KILLIAN 144, 145
- specula nasal HADEO 144
- specula nasal THUDICHUM 140
- specula nasal TIECK-HALLE 144
- specula nasal VOLTOLINI 140
- specula nasal WIEN 143
- SPENCER stich scissors 199
- spoon SHEA 134
- spoon 138
- spoon ear GROSS 65
- SPRATT bone curette 103
- spreader tracheal BOSE 314, 315
- St. CLAIR-THOMSON
adenoid curette 309
- St. CLAIR-THOMSON
nasopharyngeal forceps 310
- STACKE ear probe 63
- STANDARD dressing forceps 95
- STANDARD operating scissors 117
- STERNBERG cheek retractor 270
- STEVENS scissors 196
- stich scissors LITTAUER 199
- stich scissors O BRIEN 199
- stich scissors SPENCER 199
- stich bipolar electrode 44, 45
- STRABISMUS
dissecting scissors 116, 196
- STRUYCKEN
nasal cutting forceps 169
- suction tube BARON 128
- suction tube FERGUSSON 213
- suction tube
FRAZIER/FERGUSSON 125, 213
- suction tube PLESTER 126
- suction tube ROSEN 129
- suction tube WULLSTEIN 127
- suction handle WULLSTEIN 129
- suction tube YANKAUER 284
- suction tube YANKAUER BABY 284
- suction tube ZÖLLNER 125
- suction tube 348
- suction coagulation tube 211
- suction monopolar coagulator 43
- suction raspatory GUILLEN 227
- suction tube HOUSE 126, 214
- suction bipolar forceps 42
- suction laryngeal elevator 352
- syringe ear REINER 61
- syringe ear 62
- syringe tonsil 210, 306, 344
- T
TABB knife 122
- TAKAHASHI ethmoid forceps 165
- tamper 98
- tamper bone PASSOW 98, 235
- THILENIUS
tonsil abscess forceps 283
- THUDICHUM nasal specula 140
- thyroid dissector KOCHER 317
- thyroid retractor SCHOENBORN 317
- TIECK-HALLE nasal specula 144
- tier knot NEGUS 304
- tier laryngeal knot 352
- TILLEY ear forceps 74
- TILLEY nasal dressing forceps 155
- tip BARACANI 354
- tip BRUENINGS 354

tip CORDES	354	tonsil dissector HURD	290	tube suction	348
tip FRAENKEL	354	tonsil dissector LOPEZ-REINKE	290	tube suction HOUSE	126, 214
tip KRAUSE	354	tonsil forceps MARSCHIK	282	tube tracheal	
tip LANGE	354	tonsil forceps MIKULICZ	283	WAGENER-MOSHER	315
tip SCHEINMANN	354	tonsil needle NAGER	286	tube coagulation suction	211
tip SCHUMACHER	354	tonsil forceps NEGUS	281	tumor scissors	207
tip SEIFERT	354	tonsil scissors PRINCE	296	tuning fork HARTMANN	58
tissue forceps ADSON	97	tonsil snare ROEDER "E"	303	tuning fork LUCAE	59
tissue forceps DERLACKI	97	tonsil forceps SAWTELL	281	tuning fork RYDEL-SEIFFERT	59
tissue forceps POTTS-SMITH	294	tonsil forceps SCHNIDT	281	tuning fork	58, 59
tissue forceps SEMKEN	95	tonsil forceps TYDING	282	TYDING tonsil forceps	282
TOBOLD tongue depressor	270	tonsil snare TYDING	300	TYDING tonsil snare	300
tongue depressor ANDREW	269	tonsil forceps WHITE	281	tympaanum knife LUCAE	70
tongue depressor BRUENINGS	268	tonsil elevator YANKAUER	290	tympaanum knife POLITZER	70, 71
tongue depressor BUCHWALD	268	tonsil wire	302	tympaanum knife SEXTON	71
tongue depressor		tonsil syringe	210, 306, 344		
CAWOOD-MINNESOTA	268	tonsil needle	210, 306, 344		
tongue depressor		tonsil abscess forceps			
DAVIS-BOYLE	273	THILENIUS	283	U	
tongue blades DOUGHTY	279	tonsillectome		UCKERMANN cotton applicator	64
tongue depressor FRENZEL	268	SLUDER-BALLENGER	305	UNIVERSAL wire scissors	118, 299
tongue depressor HARTMANN	269	TOYNBEE ear specula	53	UNIVERSAL trocar sinuscopy	214
tongue depressor KROENIG	268	tracheal spreader BOSE	314, 315	UNIVERSAL powder blower	60
tongue depressor		tracheal cannula		uvula retractor LOTHROP	288
MORITZ-SCHMIDT	269	CHEVALIER-JACKSON	316	uvula retractor LOVE	288
tongue depressor RING	272	tracheal hook ITERSON	315		
tongue blades RUSSEL-DAVIS	278	tracheal hook JACKSON	314	V	
tongue depressor TOBOLD	270	tracheal dilator LABORDE	314	VOLKMANN bone curette	104
tongue depressor WIEDER	269	tracheal cannula LUER	316	VOLTOLINI nasal specula	140
tongue forceps YOUNG	270	tracheal hook NEWS	315		
tongue depressor	268	tracheal dilator TROUSSEAU	314	W	
tongue forceps COLLIN	270	tracheal dilator		WAGENER ear hook	66
tonsil forceps ABRAHAM	282	TROUSSEAU-BABY	314	WAGENER-MOSHER	
tonsil knife ABRAHAM	287	tracheal tube		tracheal tube	315
tonsil dissector ALDERDYCE	290	WAGENER-MOSHER	315	WAGNER scissors	197
tonsil forceps BALLENGER	281	trocar COAKLEY	215	WALSHAM septum straightening	
tonsil forceps BLOHMKE	281	trocar LICHTWITZ	215	forceps	160
tonsil scissors BOETTCHER	296	trocar sinuscopy UNIVERSAL	214	WALTER chisel	235
tonsil knife BRUENINGS	287	TROELTSCH nasal forceps	149	WALTER scissors	194
tonsil snare BRUENINGS	301	TROUSSEAU tracheal dilator	314	WATSON dermatome	221
tonsil knife CANFIELD	287	TROUSSEAU-BABY		WATSON-WILLIAMS	
tonsil enucleator CARPENTER	291	tracheal dilator	314	ethmoid forceps	166
tonsil needle CLAUS	285	tube suction BARON	128	WEBER-LOCH ear loop	67
tonsil forceps COLVER	281	tube suction FERGUSSON	213	WEBSTER needle holder	209
tonsil scissors DEAN	296	tube suction		WEBSTER-BABY needle holder	209
tonsil forceps DENIS BROWNE	283	FRAZIER/FERGUSSON	125, 213	WEIL-BLAKESLEY	
tonsil needle DUPUY-WEISS	285	tube suction PLESTER	126	ethmoid forceps	164
tonsil snare EVES	301	tube suction ROSEN	129	WEIL-BLAKESLEY	
tonsil knife FISHER	286	tube suction WULLSTEIN	127	nasal cutting forceps	168
tonsil scissors GOOD	296	tube suction YANKAUER	284	WEITLANER retractor	110
tonsil punch HARTMANN	307	tube suction YANKAUER BABY	284	WEITLANER-WULLSTEIN	
tonsil elevator HENKE	290	tube suction ZÖLLNER	125	retractor	110

WESTMACOTT	
nasal dressing forceps.....	154
WHITE tonsil forceps.....	281
WIEDER tongue depressor.....	269
WIEN nasal specula.....	143
WIENER nasal rasp.....	238
WILDE ear polypus snare.....	72
WILDE nasal polypus snare.....	163
WILDE (TROELTSCH)	
ear forceps.....	94
WILDE (TROELTSCH)	
nasal forceps.....	152
WILDER lachrymal dilator.....	261
WILLIGER bone curette.....	105
WILLIGER raspatory.....	87
WILLIGER retractor.....	113
WILMER scissors.....	194
wire scissors UNIVERSAL.....	118, 299
wire tonsil.....	302
WULLSTEIN suction handle.....	129
WULLSTEIN micro ear scissors.....	83
WULLSTEIN suction tube.....	127
WULLSTEIN knife.....	122
WULLSTEIN raspatory.....	92
WULLSTEIN retractor.....	112
Y	
YANKAUER tonsil elevator.....	290
YANKAUER suction tube.....	284
YANKAUER BABY suction tube.....	284
YASARGIL ear specula holder.....	57
YOUNG tongue forceps.....	270
Z	
ZAUFAL ear loop.....	65
ZAUFAL-JANSEN ear elevator.....	65
ZAUFAL-JANSEN bone rongeur.....	107
ZIEGLER head mirror.....	23
ZÖLLNER suction tube.....	125
bipolar cable.....	39
light guide cable.....	19
laryngeal cannula.....	210, 306, 344
septum cannula.....	210, 306, 344
cotton carrier.....	347
antrum curette.....	256, 257
tongue depressor.....	268
biopsy forceps.....	15
bipolar forceps.....	36, 37, 38
dressing forceps.....	295
jeweler forceps.....	96
maxillary sinus forceps.....	176, 177
micro ear forceps.....	75, 76, 77, 78, 79
nasal forceps.....	167, 180
nasal cutting forceps.....	170-174, 178
tuning fork.....	58, 59
laryngeal handle.....	346
laryngoscope handle.....	332, 333
ear hook.....	65, 66
laryngeal hook.....	352, 353
laryngeal instrument handle.....	353
laryngeal knife.....	352, 353
fibreglass laryngoscope.....	339
operation laryngoscope.....	334, 335, 340, 341
laryngeal mirror.....	346
injection needle.....	349
laryngeal needle.....	352
tonsil needle.....	210, 306, 344
laryngeal needle holder.....	349
FRENZEL nystagmus spectacle.....	22
mallet plastic.....	260
antrum punch.....	184, 185
biopsy punch.....	179
circular punch.....	186
cheek retractor.....	270
micro scissors.....	119, 131, 203-205
nasal scissors.....	187
tumor scissors.....	207
laryngoscope spare bulb.....	332, 333
ear specula.....	55, 56
ear syringe.....	62
tonsil syringe.....	210, 306, 344
suction tube.....	348
tonsil wire.....	302

A			
ABRAHAM bisturi	287	ANTRUM cureta	256
ABRAHAM pinza	282	articulacion	335
abre-boca	271, 274-277, 280	articulacion esferica.....	148
abre-boca BOYLE-DAVIS.....	274	asa.....	65, 67, 72, 163
abre-boca DAVIS-BOYLE.....	274	asa BILLEAU	65
abre-boca DAVIS-MEYER.....	277	asa LANGENBECK	65
abre-boca DENHART	271	asa LOCH-WEBER	67
abre-boca DINGMANN.....	276	asa SHAPLEIGH	67
abre-boca DOUGHTY-KILNER	275	asa WEBER-LOCH	67
abre-boca		ASCH pinza	160
DOYEN-JANSEN (MOLT)	271	AUFRIEHT escofina	239
abre-boca HEISTER.....	271	AUFRIEHT retractor	251
abre-boca		auricular especulo	53-56
JANSEN-DOYEN (MOLT)	271	auricular pinza	74-79
abre-boca JENNINGS	271		
abre-boca KILNER-DOUGHTY	275	B	
abre-boca KOENIG-ROSER	271	BABY ROUX separador	263
abre-boca MAUNDER	280	BABY-TROUSSEAU dilatador.....	314
abre-boca McIVOR.....	277	BABY-WEBSTER porta aguja	209
abre-boca MEYER-DAVIS	277	BABY-YANKAUER	
abre-boca		tubo de succion	284
MOLT (DOYEN-JANSEN)	271	baja nudos	352
abre-boca ROSER-KOENIG	271	baja-lengua	
acoplamiento	148	268-270, 272-273, 275-279
adaptador	20, 24-25, 129	baja-lengua ANDREW	269
adaptador HOUSE.....	129	baja-lengua BOYLE-DAVIS	273
adenotomo LAFORCE.....	309	baja-lengua BRUENINGS	268
ADSON pinza	97	baja-lengua BUCHWALD	268
ADSON separador.....	112	baja-lengua DAVIS-BOYLE	273
aguja	70-71, 135-136, 210,	baja-lengua DAVIS-RUSSEL.....	278
.....	285-286, 306, 344, 352-353	baja-lengua DINGMANN	276
aguja BARBARA / ROSEN ...	135, 136	baja-lengua DOUGHTY	279
aguja CLAUS.....	285	baja-lengua DOUGHTY-KILNER	275
aguja DUPUY-WEISS.....	285	baja-lengua FRENZEL	268
aguja LUCAE.....	70	baja-lengua HARTMANN	269
aguja NAGER	286	baja-lengua KILNER-DOUGHTY	275
aguja POLITZER	70-71	baja-lengua KROENING.....	268
aguja ROSEN / BARBARA... 135, 136		baja-lengua McIVOR	277
aguja WEISS-DUPUY	285	baja-lengua MORITZ-SCHMIDT	269
alambre para polipotomo.....	319	baja-lengua RUSSEL-DAVIS.....	278
ALDERDYCE elevador.....	290	baja-lengua SCHMIDT-MORITZ.....	269
ALM separador	110	baja-lengua TOBOLD	270
amigdalotomo		baja-lengua WIEDER	269
BALLENGER-SLUDER	305	BALLENGER bisturi	218
amigdalotomo		BALLENGER elevador	225
SLUDER-BALLENGER	305	BALLENGER pinza	281
ANDERSON-NEIVERT		BALLENGER-HAJEK elevador	225
osteotomo.....	233	BALLENGER-SLUDER	
ANDREW baja-lengua.....	269	amigdalotomo.....	305
anillo	335	BANE-HARTMANN pinza gubia... 106	
anteojos FRENZEL.....	22	BARACANI punta	354
		BARANY ensordecedor.....	60
		BARBARA / ROSEN aguja... 135, 136	
		BARBARA gancho.....	135, 136
		BARBON-LUBET pinza	154
		BARNHILL cuchillo	308
		BARON tubo de aspiracion	128
		BARRAQUER porta aguja.....	123
		BARSKY gancho	248
		BARTH cucharilla	104
		BECKMANN cuchillo	308
		BELLUCCI tijera	80
		BERGMANN gancho	250
		BEUSE tijera.....	201
		BEYER pinza gubia	107
		BILLEAU asa.....	65
		bipolar cable.....	39
		bipolar electrodo	44-45
		bipolar pinza	36-38, 40-42
		bipolar pinza de succion.....	42
		bisturi	216-219, 286-287
		bisturi ABRAHAM	287
		bisturi BALLENGER	218
		bisturi BRUENINGS.....	287
		bisturi CANFIELD	287
		bisturi CONVERSE.....	217
		bisturi COTTLE.....	217
		bisturi FISHER.....	286
		bisturi FREER.....	216
		bisturi JOSEPH.....	216-217
		bisturi HADEO	217
		BLAKESLEY pinza	180
		BLAKESLEY-WEIL pinza.....	164, 168
		BLOHMKE pinza	281
		BLUMENTHAL pinza gubia	106
		BOETTCHEER tijera	296
		BÖHLER pinza gubia	107-108
		BOIES elevador.....	226
		bombilla	22, 26, 27, 332-333
		BONN tijera	192
		BOSE gancho.....	315
		BOSE separador	314
		BOUCHERON especulo auricular	53
		BOWMAN sonda.....	262, 293
		BOYLE-DAVIS abre-boca.....	274
		BOYLE-DAVIS baja-lengua	273
		brazo de soporte.....	148
		brazo flexible	57
		broca.....	30-31
		broncoscopio	18
		BROWNE DENIS pinza.....	283
		BRUENINGS baja-lengua	268
		BRUENINGS bisturi.....	287
		BRUENINGS cierranudo	301

BRUENINGS especulo auricular ...55	cincel WEST236	cuchillo BECKMANN308
BRUENINGS pinza158	CINELLI cincel.....232	cuchillo FREER-INGALS219
BRUENINGS punta354	cinta23	cuchillo INGALS-FREER219
BRUENINGS tubo de extension...354	CITELLI pinza sacabocado109	cuchillo MASING219
BRÜNINGS-BRUNK separador ...263	CLAR lampara frontal.....26	cuchillo PLESTER122
BRÜNINGS-LUCAS gubia.....98	CLAUS aguja.....285	cuchillo POLITZER71
BRUNK-BRÜNINGS separador...263	CLAUS-KILLIAN cincel.....236	cuchillo ROSEN.....120
BUCHWALD baja-lengua268	coagulador de succion monopolar..43	cuchillo SCHUKNECHT.....122
BUCK cureta68-69	COAKLEY cureta.....256	cuchillo SEXTON.....71
BUCK elevador.....73	COAKLEY trocar215	cuchillo St. CLAIR-THOMSON309
C	COLLIN pinza270	cuchillo TABB122
cable19, 39	COLVER pinza281	cuchillo THOMSON-St. CLAIR309
cable bipolar39	cono61	cuchillo WULLSTEIN122
CANFIELD bisturi287	CONVERSE bisturi.....217	cureta65, 68-69, 133, 256
canula CHEVALIER-JACKSON...316	CONVERSE gancho.....252	cureta ANTRUM256
canula de inyeccion.....337, 349	CONVERSE/WILMER/	cureta BUCK.....68-69
canula de succion.....338	WALTER tijera194	cureta COAKLEY.....256
canula JACKSON-CHEVALIER...316	CORDES punta354	cureta FAULKNER.....256
canula LUER316	COTTLE (MALTZ) escofina.....239	cureta HOUSE133
canula MOSHER-WAGENER315	COTTLE bisturi217	cureta y gancho GROSS65
canula para laringe.....210, 306, 344	COTTLE cincel100, 231	
canula traqueal315-316	COTTLE elevador.....224-225	D
canula WAGENER-MOSHER315	COTTLE especulo nasal146-147	DAUBENSPECK cucharilla258
CAPLAN tijera206	COTTLE gancho252-255	DAVIS-BOYLE abre-boca.....274
CARPENTER disector.....291	COTTLE machacadora237	DAVIS-BOYLE baja-lengua273
CARPENTER enucleador.....291	COTTLE martillo102, 260	DAVIS-MEYER abre-boca.....277
CASTROVIEJO porta aguja124	COTTLE pinza94, 152-153	DAVIS-RUSSEL baja-lengua278
cateter.....70	COTTLE retractor251	DAY gancho.....66
cateter HARTMANN70	COTTLE tijera.....194, 198	DEAN tijera296
CAWOOD-MINNESOTA	COTTLE-KAZANJIAN	DENHART abre-boca271
separador268	pinza gubia108, 208	DENIS BROWNE pinza283
CHEVALIER-JACKSON canula...316	COTTLE-MASING tijera198	depresor REICHERT343
CHEVALIER-JACKSON pinza	COTTLE-NEIVERT gancho.....252	DERF porta aguja209
para bronco-esofagoscopia356	CRAIG pinza.....158	DERLACKI pinza97
cierranudo.....300-301, 303, 319	CRAIG-DOMNICK pinza158	dermatomo HUMBY221
cierranudo BRUENINGS301	CRILE-WOOD porta aguja209	dermatomo SCHINK.....220
cierranudo EVES301	cucharilla	dermatomo SILVER.....221
cierranudo ROEDER "E"303103-105, 134, 138, 257-258	dermatomo WATSON221
cierranudo TYDING300	cucharilla BARTH104	diapason58-59
cincel98-100, 230-233, 235-236	cucharilla DAUBENSPECK258	diapason LUCAE59
cincel CINELLI232	cucharilla HALLE104, 258	diapason RYDEL-SEIFFERT.....59
cincel CLAUS-KILLIAN.....236	cucharilla JANSEN103	DIETER pinza84
cincel COTTLE100, 231	cucharilla LEMPert103	dilatador261, 314
cincel FOMON232	cucharilla MARTINI.....105	dilatador BABY-TROUSSEAU.....314
cincel FREER100, 230, 236	cucharilla para antro257	dilatador LABORDE.....314
cincel HAJEK.....236	cucharilla SHEA.....134	dilatador TROUSSEAU314
cincel KILLIAN-CLAUS.....236	cucharilla SPRATT103	dilatador TROUSSEAU-BABY.....314
cincel PARTSCH99	cucharilla VOLKMANN104	dilatador WILDER.....261
cincel PASSOW.....98, 235	cucharilla WILLIGER105	DINGMAN lima130, 244
cincel SILVER.....233	cuchillo.....71, 120-122, 219,	DINGMANN abre-boca.....276
cincel WALTER.....235308-309, 352-353	DINGMANN baja-lengua276
	cuchillo BARNHILL308	disector93, 290-291

disector CARPENTER.....	291	elevador SEWALL	226	espejo laringeal MICHEL.....	345
disector FISCH	93	elevador SINUS.....	223	estuche diagnostico.....	48-52
disector HURD.....	290	elevador YANKAUER	290	estuche diagnostico ECO	51
disector LOPEZ-REINKE.....	290	elevador ZAUFAL	65	estuche diagnostico RI-MINI	52
disector REINKE-LOPEZ.....	290	elevador ZAUFAL-JANSEN.....	65	estuche diagnostico UNI III.....	50
dispositivo de fijacion para tubos		endolaringeal endoscopio.....	18	EVES cierranudo.....	301
.....	57, 148	endoscopio	15-18		
dispositivo para modelar		endoscopio endolaringeal.....	18		
SCHUKNECHT.....	85	ensordecador BARANY.....	60	F	
DOMNICK-CRAIG pinza	158	enucleador CARPENTER.....	291	FARABEU periototomo.....	90
DOUGHTY baja-lengua.....	279	escofina	238-244	faringscopio	16
DOUGHTY-KILNER abre-boca	275	escofina AUFRICHT	239	FARRELL porta-algodon	63
DOUGHTY-KILNER baja-lengua..	275	escofina COTTLE (MALTZ).....	239	FARRIOR especulo auricular	54
DOYEN-JANSEN (MOLT)		escofina FOMON.....	240-241	FAULKNER cureta.....	256
abre-boca	271	escofina GALLAHER	243	FEIN porta-algodon	347
DUPLAY pinza.....	295	escofina GLABELLA	238	FERGUSON / FRAZIER	
DUPUY-WEISS aguja.....	285	escofina JOSEPH.....	238	tubo de aspiracion	125, 213
		escofina JOSEPH (LEWIS).....	239	FERGUSON tubo de aspiracion	213
E		escofina LEWIS (JOSEPH).....	239	FERRIS-SMITH-KERRISON	
ECO estuche diagnostico	51	escofina MALTZ.....	238	pinza.....	181
EICKEN (KILLIAN)		escofina MALTZ (COTTLE).....	239	FINSEN separador	110
tubo de aspiracion	212	escofina MASING	242	FISCH disector	93
Electrocirugia.....	34-38, 40-45	escofina PARKES.....	238	FISCH separador.....	112, 265
electrodo	34-35, 44-45	escofina PEET.....	238	FISCH tijera.....	82
electrodo bipolar	44-45	escofina WIENER	238	FISHER bisturi.....	286
electrodo bipolar MICRODOME	45	especulo auricular	53-56	FOMON cincel.....	232
elevador	65, 73, 86, 88, 91-92,	especulo auricular BOUCHERON..	53	FOMON escofina.....	240-241
.....	138, 222-226, 290	especulo auricular BRUENINGS....	55	FOMON gancho	253
elevador ALDERDYCE.....	290	especulo auricular FARRIOR	54	FOMON tijera	198
elevador BALLENGER	225	especulo auricular GRUBER.....	53	FRAENKEL pinza	342
elevador BALLENGER-HAJEK	225	especulo auricular HARTMANN	53	FRAENKEL punta.....	354
elevador BOIES.....	226	especulo auricular POLITZER.....	53	FRAZIER / FERGUSON	
elevador BUCK.....	73	especulo auricular SIEGLE	56	tubo de aspiracion	125, 213
elevador COTTLE.....	224-225	especulo auricular TOYNBEE	53	FRAZIER gancho	246
elevador FREER.....	91, 223	especulo nasal	140-147	FREEMAN-GORNEY tijera	200
elevador GOLDMANN.....	226	especulo nasal COTTLE	146-147	FREER bisturi.....	216
elevador HAJEK-BALLENGER	225	especulo nasal		FREER cincel	100, 230, 236
elevador HALLE	222	especulo nasal		FREER elevador.....	91, 223
elevador HENKE	290	HALLE-HARTMANN.....	141	FREER gancho.....	254
elevador HOWARTH	224	especulo nasal HALLE-TIECK	144	FREER-INGALS cuchillo	219
elevador JANSEN-ZAUFEL.....	65	especulo nasal HARTMANN	142	FRENZEL anteojos.....	22
elevador JOSEPH	222	especulo nasal		FRENZEL baja-lengua	268
elevador KILLIAN	223, 225	HARTMANN-HALLE.....	141	FROHN porta-algodon	63
elevador LEMPert.....	88, 91	especulo nasal KILLIAN	144-145	frontal lampara.....	24-27
elevador MASING.....	222	especulo nasal Mod. WIEN	143	FRONTAL sonda	261
elevador McKENTY	92, 222, 224	especulo nasal HADEO	144		
elevador PENNINGTON	224	especulo nasal THUDICHUM.....	140	G	
elevador PIERCE	223	especulo nasal TIECK-HALLE	144	GALLAHER escofina.....	243
elevador QUERVAIN	86	especulo nasal VOLTOLINI	140	gancho	65, 66, 135-137, 246-250,
elevador QUIRE.....	73	especulo nasal WIEN Mod.	143	252-255, 314-315, 352-353
elevador ROGER.....	222	espejo	23, 26	gancho BARBARA	135, 136
elevador SEBILEAU	86	espejo frontal ZIEGLER.....	23	gancho BARSKY	248
		espejo laringeal	345-346	gancho BERGMANN.....	250

gancho BOSE	315	gubia LEXER MINI	100	HOUSE-GELFOAM pinza	85
gancho CONVERSE	252	gubia LUCAS-BRÜNNINGS	98	HOWARTH elevador	224
gancho COTTLE	252-255	gubia MINI LEXER	100	HUBER mango	354
gancho COTTLE-NEIVERT	252	gubia PARTSCH	99	HUMBY dermatomo	221
gancho DAY	66	GUILLEN legra	227	HUMBY gancho	248
gancho FOMON	253	GUILLEN periostotomo	227	HURD disector	290
gancho FRAZIER	246	GUTHRIE gancho	246		
gancho FREER	254			I	
gancho GILLIES	254	H		INGALS-FREER cuchillo	219
gancho GRAEFE	246	HAJEK cincel	236	instrumento de aspiracion y	
gancho GUTHRIE	246	HAJEK martillo	102	irrigacion	210-211
gancho HUMBY	248	HAJEK-BALLENGER elevador	225	instrumento para laringoscopia	
gancho ITERSON	315	HAJEK-KOFLER pinza	182-183	352-353
gancho JACKSON	314	HALLE cucharilla	104, 258	insuflador de aire POLITZER	61
gancho JOSEPH	247	HALLE elevador	222	IRIS tijera	117, 192
gancho KILNER	253	HALLE-HARTMANN		ITERSON gancho	315
gancho KLEINERT-KUTZ	247	especulo nasal	141		
gancho KNAPP	250	HALLE-RITTER sonda	261	J	
gancho KUTZ-KLEINERT	247	HALLE-TIECK especulo nasal	144	JACKSON gancho	314
gancho LAHEY	246	HALSEY porta aguja	209	JACKSON laringoscopio	340
gancho LANGE	255	HARTMANN baja-lengua	269	JACKSON pinza laríngea	343
gancho LUCAE	66, 250	HARTMANN cateter	70	JACKSON-CHEVALIER canula	316
gancho McGEE	136	HARTMANN especulo auricular	53	JACKSON-CHEVALIER pinza	
gancho NEIVERT-COTTLE	252	HARTMANN especulo nasal	142	para bronco-esofagoscopia	356
gancho NEWS	315	HARTMANN pinza		JAMESON (REYNOLDS) tijera	191
gancho PLESTER	137	74-75, 154, 169, 175, 307	JANSEN cucharilla	103
gancho HADEO	249	HARTMANN-BANE pinza gubia	106	JANSEN periostotomo	91
gancho ROLLET	250	HARTMANN-HALLE		JANSEN pinza	150
gancho SHAMBAUGH	135	especulo nasal	141	JANSEN separador	110
gancho WAGENER	66	HARTMANN-HOFFMANN		JANSEN-DOYEN (MOLT)	
gancho y cureta GROSS	65	pinza	75, 175	abre-boca	271
GELFOAM-HOUSE pinza	85	HARTMANN-WEINGÄRTNER		JANSEN-GRUENWALD pinza	150
GERZOG martillo	259	pinza	75	JANSEN-MIDDLETON pinza	159
GILLIES gancho	254	HARTMANN-WULLSTEIN		JANSEN-ZAUFAL elevador	65
GILLIES pinza	151	pinza	75, 175	JANSEN-ZAUFAL pinza gubia	107
GLABELLA escofina	238	HEISTER abre-boca	271	JATHO pinza naso-faríngea	310
GOLDMANN elevador	226	HENKE elevador	290	JENNINGS abre-boca	271
GOOD tijera	296	HEYMAN tijera	198	jeringa	61-62, 210, 306, 344
GORNEY tijera	116, 200	HEYMANN pinza	157	jeringa REINER	61
GORNEY-FREEMAN tijera	200	HEYMANN-KNIGHT pinza	156	JOBSON-HORNE porta-algodon	64
GRADLE tijera	195	hilo para amígdalas	302	JOSEPH (LEWIS) escofina	239
GRAEFE gancho	246	HOFER separador	289	JOSEPH bisturi	216-217
GRAEFE pinza	95, 151	HOFFMANN-HARTMANN		JOSEPH elevador	222
GRAEFE tijera	194	pinza	75, 175	JOSEPH escofina	238
grapa para iluminacion	338, 341	hoja de repuesto	220-221	JOSEPH gancho	247
GREENBERG-PAR tijera	202	HOLINGER laringoscopio	339	JOSEPH periostotomo	88
GREVEN tijera	81	HOLZHEIMER separador	110	JOSEPH sierra nasal	244-245
GROSS gancho y cureta	65	horquilla NEGUS	304	JOSEPH tijera	116, 190
GRUBER especulo auricular	53	HOUSE adaptador	129	JOSEPH-PECK tijera	201
GRUENWALD-JANSEN pinza	150	HOUSE cureta	133	JURASZ pinza	311, 342
gubia	98-100	HOUSE sonda	132		
gubia BRÜNNINGS-LUCAS	98	HOUSE tubo de aspiracion	126, 214		

K		M
KABIERSKE lanzapolvo60	LANGENBECK periostotomo86	machacadora COTTLE.....237
KAYE tijera201-202	LANGENBECK-KOCHER	MALTZ (COTTLE) escofina239
KAZANJIAN-COTTLE	separador263	MALTZ escofina.....238
pinza gubia108, 208	lanzapolvo60	mango de pila332-333
KELLY tijera.....191	lanzapolvo KABIERSKE60	mango de succion127, 129
KERRISON	lanzapolvo UNIVERSAL60	mango de succion
pinza sacabocado.....109, 182	laringoscopio17	WULLSTEIN127, 129
KERRISON-FERRIS-SMITH	laringoscopio . 322-331, 334, 339-341	mango HUBER354
pinza181	laringoscopio HOLINGER.....339	mango para espejo laringeal346
KILLIAN (EICKEN)	laringoscopio JACKSON340	mango para instrumentos
tubo de aspiracion212	laringoscopio McCOY324, 331	microlaringeos353
KILLIAN elevador223, 225	laringoscopio McINTOSH	mango para laringoscopio
KILLIAN especulo nasal144-145322-323, 327-328332-333, 336
KILLIAN porta-algodon347	laringoscopio MILLER	MARSCHIK pinza282
KILLIAN tijera343325-326, 329-330	martillo102, 259-260
KILLIAN tubo de aspiracion212	laringoscopio operativo	martillo COTTLE.....102, 260
KILLIAN-CLAUS cincel.....236334-335, 340-341	martillo GERZOG259
KILNER (RAGNELL) tijera.....191	lazo65, 67	martillo HAJEK102
KILNER gancho.....253	legra de succion353	martillo MEAD102, 259
KILNER-DOUGHTY abre-boca275	legra GUILLEN227	martillo PARTSCH102, 260
KILNER-DOUGHTY baja-lengua.....275	LEMPERT cucharilla103	martillo QUISLING.....260
KLEINERT-KUTZ gancho.....247	LEMPERT elevador88, 91	MARTINI cucharilla.....105
KLEINERT-KUTZ pinza gubia107	LEMPERT pinza gubia107	MASING cuchillo219
KNAPP gancho.....250	LEWIS (JOSEPH) escofina239	MASING elevador.....222
KNAPP tijera.....193	LEXER MINI gubia100	MASING escofina242
KNIGHT pinza157	LEXER MINI osteotomo100	MASING-COTTLE tijera198
KNIGHT-HEYMANN pinza156	LEXER osteotomo228	MASING-NEIVERT retractor251
KOCHER sonda317	LEYLA separador148	MASTIN pinza318
KOCHER-LANGENBECK	LICHTWITZ trocar215	MAUNDER abre-boca280
separador263	lima130, 238-244	MC INDOE pinza gubia108, 208
KOENIG-ROSER abre-boca271	lima DINGMAN130, 244	McGEE gancho136
KOFLER-HAJEK pinza.....182-183	LINDEMANN sierra nasal.....245	McGEE tijera81
KÖNIG periostotomo86	LISTER (SINUS) pinza155	McINDOE pinza.....151
KRAUSE polipotomo72, 162	LITTAUER pinza74, 156	McIVOR abre-boca277
KRAUSE punta.....354	LITTAUER tijera.....199	McIVOR baja-lengua277
KRAUSE-VOSS polipotomo162	LITTLER tijera194	McKENTY elevador92, 222, 224
KROENING baja-lengua.....268	LOCH-WEBER asa67	MEAD martillo.....102, 259
KUTZ-KLEINERT gancho.....247	LOPEZ-REINKE disector.....290	METZENBAUM FINO tijera ..115, 189
KUTZ-KLEINERT pinza gubia107	LOTHROP separador288	METZENBAUM tijera
	LOVE separador288115, 188-189, 297
L	LUBET-BARBON pinza154	MEYER-DAVIS abre-boca.....277
LABORDE dilatador.....314	LUC pinza157	MICHEL espejo laringeal345
LAFORCE adenotomo.....309	LUCAE aguja.....70	micro pinza131, 350-351
LAHEY gancho246	LUCAE diapason59	micro tijera119, 131, 203-205, 351
LAHEY pinza318	LUCAE gancho66, 250	MICRODOME electrodo bipolar45
LAMBOTTE-MINI osteotomo.....99, 229	LUCAE pinza94, 152	MIDDELDPF separador263
lampara frontal.....24-27	LUCAS-BRÜNINGS gubia.....98	MIDDLETON-JANSEN pinza159
lampara frontal CLAR.....26	LUER canula316	MIKULICZ pinza283
LANGE gancho.....255	LUER pinza gubia.....106	MILLER periostotomo92
LANGE punta354	LUNIATSCHEK tamponador292	MINI LEXER gubia100
LANGENBECK asa65		MINI LEXER osteotomo100

MINI-LAMBOTTE osteotomo..99, 229	PARTSCH gubia.....99	pinza GRUENWALD-JANSEN 150
MINNESOTA-CAWOOD	PARTSCH martillo 102, 260	pinza gubia106-108
separador268	PASSOW cincel.....98, 235	pinza gubia BANE-HARTMANN... 106
Mod. WIEN espejuelo nasal 143	PECK-JOSEPH tijera 201	pinza gubia BEYER 107
MOLLISON separador..... 112	PEET escofina.....238	pinza gubia BLUMENTHAL..... 106
MOLT (DOYEN-JANSEN)	PENNINGTON elevador.....224	pinza gubia BÖHLER 107-108
abre-boca271	pera de goma61	pinza gubia
MOLT periostotomo.....92	periostotomo.....86-93, 138, 227, 353	COTTLE-KAZANJIAN 108, 208
monopolar coagulador de succion..43	periostotomo FARABEUF.....90	pinza gubia HARTMANN-BANE... 106
MORITZ-SCHMIDT baja-lengua ..269	periostotomo GUILLEN227	pinza gubia JANSEN-ZAUFAL 107
MOSHER-WAGENER canula315	periostotomo JANSEN.....91	pinza gubia
N	periostotomo JOSEPH88	KAZANJIAN-COTTLE 108, 208
NAGER aguja.....286	periostotomo KÖNIG86	pinza gubia KLEINERT-KUTZ 107
NAGER separador.....289	periostotomo LANGENBECK86	pinza gubia KUTZ-KLEINERT 107
nasolarinoscopio..... 14	periostotomo MILLER.....92	pinza gubia LEMPERT 107
NEGUS horquilla304	periostotomo MOLT92	pinza gubia LUER.....106
NEGUS pinza281	periostotomo ROSEN.....93	pinza gubia MC INDOE 108, 208
NEGUS soporte de pecho280	periostotomo WILLIGER.....87	pinza gubia ZAUFAL-JANSEN 107
NEIVERT-ANDERSON	periostotomo WULLSTEIN92	pinza HAJEK-KOFLER.....182-183
osteotomo.....233	PERWITZSCHKY298	pinza HARTMANN
NEIVERT-COTTLE gancho252	PIERCE elevador22374-75, 154, 169, 175, 307
NEIVERT-MASING retractor251	pinza ABRAHAM282	pinza
NEWS gancho315	pinza ADSON97	HARTMANN-HOFFMANN.....75, 175
NOYES pinza155	pinza ASCH160	pinza
O	pinza auricular ...74-79, 84-85, 94-97	HARTMANN-WEINGÄRTNER75
O'BRIEN tijera199	pinza BALLENGER281	pinza
OBWEGESER osteotomo234	pinza BARBON-LUBET154	HARTMANN-WULLSTEIN75, 175
oftalmoscopio UNI II49	pinza bipolar36-38, 40-42	pinza HEYMANN157
optica pinza15	pinza BLAKESLEY180	pinza HEYMANN-KNIGHT156
osteotomo	pinza BLAKESLEY-WEIL.....164, 168	pinza
.....99-101, 228-229, 233-234	pinza BLOHMKE281	HOFFMANN-HARTMANN.....75, 175
osteotomo	pinza BROWNEN DENIS.....283	pinza HOUSE-GELFOAM85
ANDERSON-NEIVERT233	pinza BRUENINGS.....158	pinza JANSEN150
osteotomo LAMBOTTE-MINI..99, 229	pinza circular186	pinza JANSEN-GRUENWALD 150
osteotomo LEXER228	pinza COLLIN.....270	pinza JANSEN-MIDDLETON 159
osteotomo LEXER MINI100	pinza COLVER281	pinza JURASZ.....311, 342
osteotomo MINI LEXER100	pinza COTTLE.....94, 152-153	pinza
osteotomo MINI-LAMBOTTE..99, 229	pinza CRAIG158	KERRISON-FERRIS-SMITH 181
osteotomo	pinza CRAIG-DOMNICK158	pinza KNIGHT157
NEIVERT-ANDERSON.....233	pinza de diseccion.....95	pinza KNIGHT-HEYMANN156
osteotomo OBWEGESER234	pinza de succion bipolar42	pinza KOFLER-HAJEK.....182-183
osteotomo RUBIN.....234	pinza DENIS BROWNE.....283	pinza LAHEY318
osteotomo SHEEHAN101, 232	pinza DERLACKI.....97	pinza laringeal JACKSON343
otoscopio17, 48	pinza DIETER.....84	pinza LISTER (SINUS).....155
otoscopio UNI I.....48	pinza DOMNICK-CRAIG158	pinza LITTAUER.....74, 156
P	pinza DUPLAY.....295	pinza LUBET-BARBON154
PAR-GREENBERG tijera202	pinza	pinza LUC157
PARKES escofina.....238	FERRIS-SMITH-KERRISION181	pinza LUCAE94, 152
PARTSCH cincel99	pinza FRAENKEL342	pinza MARSCHIK282
	pinza GELFOAM-HOUSE85	pinza MASTIN318
	pinza GILLIES151	pinza McINDOE.....151
	pinza GRAEFE95, 151	pinza micro131, 350-351

pinza MIDDLETON-JANSEN	159	placa para el paladar	277	R	
pinza MIKULICZ	283	placa para extender la piel	220	RAGNELL (KILNER) tijera.....	191
pinza nasal	149-161, 164-186	PLESTER cuchillo	122	HADEO bisturi	217
pinza naso-faringea JATHO	310	PLESTER gancho	137	HADEO especulo nasal	144
pinza naso-faringea		PLESTER separador	113, 264	HADEO gancho	249
ST.CLAIR-THOMSON	310	PLESTER tubo de aspiracion	126	HADEO porta-algodon.....	64
pinza NEGUS	281	polipotomo.....	72, 162-163	REICHERT depresor	343
pinza NOYES	155	polipotomo KRAUSE	72, 162	REINER jeringa	61
pinza optica	15	polipotomo KRAUSE-VOSS	162	REINKE-LOPEZ disector.....	290
pinza para amigdalas	281-283	polipotomo VOSS-KRAUSE	162	retractor AUFRICHT	251
pinza para antro.....	184-185	polipotomo WILDE.....	72, 163	retractor COTTLE	251
pinza para biopsia	167, 179	POLITZER aguja.....	70-71	retractor MASING-NEIVERT	251
pinza para bronco-esofagoscopia		POLITZER aguja.....	71	retractor nasal.....	251
CHEVALIER-JACKSON	356	POLITZER cuchillo	53	retractor NEIVERT-MASING	251
pinza para bronco-esofagoscopia		POLITZER especulo auricular.....	61	REYNOLDS (JAMESON) tijera	191
JACKSON-CHEVALIER	356	POLITZER insuflador de aire	61	RI-MINI estuche diagnostico	52
pinza porta-esponja.....	295	porta aguja.....	123-124, 209, 349	RITTER-HALLE sonda	261
pinza relojero	96	porta aguja BABY-WEBSTER	209	ROEDER "E" cierranudo	303
pinza RUBIN.....	161	porta aguja BARRAQUER.....	123	ROGER elevador.....	222
pinza sacabocado.....	109	porta aguja CASTROVIEJO	124	ROLLET gancho	250
pinza sacabocado CITELLI	109	porta aguja CRILE-WOOD	209	ROSEN / BARBARA aguja... 135, 136	
pinza sacabocado		porta aguja DERF	209	ROSEN cuchillo.....	120
KERRISON.....	109, 182	porta aguja HALSEY	209	ROSEN periostotomo	93
pinza SAWTELL	281	porta aguja WEBSTER.....	209	ROSEN tubo de aspiracion	129
pinza SCHMEDEN	169	porta aguja WEBSTER-BABY	209	ROSER-KOENIG abre-boca	271
pinza SCHNIDT	281	porta aguja WOOD-CRILE	209	ROUX BABY separador	263
pinza SEMKEN.....	95	porta-algodon	63-64	RUBIN osteotomo.....	234
pinza SINUS (LISTER)	155	porta-algodon	347	RUBIN pinza.....	161
pinza		porta-algodon FARRELL	63	RUSSEL-DAVIS baja-lengua.....	278
SMITH-FERRIS-KERRISON	181	porta-algodon FEIN	347	RYDEL-SEIFFERT diapason.....	59
pinza STANDARD	95	porta-algodon FROHN.....	63		
pinza STRUEMPEL.....	75	porta-algodon JOBSON-HORNE	64	S	
pinza STRUYCKEN.....	169	porta-algodon KILLIAN	347	SANVENERO tijera	190
pinza TAKAHASHI.....	165	porta-algodon HADEO	64	SAWTELL pinza	281
pinza THILENIUS	283	porta-algodon UCKERMANN	64	SCHEINMANN punta	354
pinza TILLEY	74, 155	portador de luz.....	334, 337-341	SCHINK dermatomo.....	220
pinza TROELTSCH	149	PRINCE tijera	296	SCHMEDEN pinza	169
pinza TROELTSCH (WILDE).....	94, 152	punta BARACANI	354	SCHMIDT-MORITZ baja-lengua...269	
pinza TYDING	282	punta BRUENINGS	354	SCHNIDT pinza	281
pinza WALSHAM	160	punta CORDES	354	SCHOENBORN separador.....	317
pinza WATSON-WILLIAMS	166	punta FRAENKEL.....	354	SCHUKNECHT cuchillo.....	122
pinza WEIL-BLAKESLEY	164, 168	punta KRAUSE	354	SCHUKNECHT	
pinza		punta LANGE	354	dispositivo para modelar.....	85
WEINGÄRTNER-HARTMANN	75	punta SCHEINMANN	354	SCHUKNECHT tijera	81
pinza WESTMACOTT	154	punta SCHUMACHER.....	354	SCHUMACHER punta.....	354
pinza WHITE	281	punta SEIFERT	354	SEBILEAU elevador	86
pinza WILDE (TROELTSCH).....	94, 152	Q		SEIFERT punta	354
pinza WILLIAMS-WATSON	166	QUERVAIN elevador	86	SEMKEN pinza.....	95
pinza WULLSTEIN	79	QUIRE elevador	73	separador	110-114, 148, 263-265,
pinza		QUISLING martillo.....	260268, 270, 288-289, 314, 317	
WULLSTEIN-HARTMANN	75, 175			separador ADSON.....	112
pinza YOUNG.....	270			separador ALM	110

separador BABY ROUX	263	SLUDER-BALLENGER		tijera COTTLE	194, 198
separador BOSE	314	amigdalotomo	305	tijera COTTLE-MASING	198
separador BRÜNING-S-BRUNK.....	263	SMITH-FERRIS-KERRISON		tijera DEAN.....	296
separador BRUNK-BRÜNING-S.....	263	pinza	181	tijera FISCH.....	82
separador		sonda63, 132, 261-262, 293, 317		tijera FOMON	198
CAWOOD-MINNESOTA.....	268	sonda auricular STACKE.....	63	tijera FREEMAN-GORNEY	200
separador FINSSEN	110	sonda BOWMAN	262, 293	tijera GOOD	296
separador FISCH.....	112, 265	sonda FRONTAL	261	tijera GORNEY	116, 200
separador HOFER.....	289	sonda HALLE-RITTER	261	tijera GORNEY-FREEMAN.....	200
separador HOLZHEIMER.....	110	sonda HOUSE	132	tijera GRADLE	195
separador JANSEN	110	sonda KOCHER	317	tijera GRAEFE.....	194
separador		sonda RITTER-HALLE	261	tijera GREENBERG-PAR	202
KOCHER-LANGENBECK	263	sonda SINUS.....	261	tijera GREVEN.....	81
separador		soporte	57, 280, 335-336	tijera HEYMAN	198
LANGENBECK-KOCHER	263	soporte de pecho NEGUS.....	280	tijera IRIS.....	117, 192
separador LEYLA	148	soporte para espejos		tijera JAMESON (REYNOLDS)	191
separador LOTHROP	288	auriculares.....	57	tijera JOSEPH	116, 190
separador LOVE.....	288	soporte para espejos		tijera JOSEPH-PECK	201
separador MIDDELDORPF	263	auriculares YASARGIL	57	tijera KAYE	201-202
separador		soporte pectoral LEWY	336	tijera KELLY	191
MINNESOTA-CAWOOD.....	268	SPENCER tijera	199	tijera KILLIAN	343
separador MOLLISON.....	112	SPRATT cucharilla	103	tijera KILNER (RAGNELL)	191
separador NAGER.....	289	St. CLAIR-THOMSON cuchillo.....	309	tijera KNAPP	193
separador PLESTER.....	113, 264	ST.CLAIR-THOMSON		tijera LITTAUER.....	199
separador ROUX BABY	263	pinza naso-faringea.....	310	tijera LITTLER	194
separador SCHOENBORN.....	317	STACKE sonda auricular	63	tijera MASING-COTTLE	198
separador STERNBERG	270	STANDARD pinza	95	tijera McGEE	81
separador WEITLANER	111	STANDARD tijera	117	tijera METZENBAUM	
separador		STERNBERG separador.....	270	115, 188-189, 297
WEITLANER-WULLSTEIN.....	111	STEVENS tijera.....	196	tijera METZENBAUM FINO ..	115, 189
separador WILLIGER	114	STRABISMUS tijera	116, 196	tijera micro	119, 131, 203-205, 351
separador WULLSTEIN	113	STRUEMPEL pinza	75	tijera nasal	187-207
separador		STRUYCKEN pinza.....	169	tijera O'BRIEN	199
WULLSTEIN-WEITLANER.....	111			tijera para alambre y	
SET.....	358-372	T		laminas	118, 299
SEWALL elevador	226	TABB cuchillo	122	tijera para amígdalas	296-298
SEXTON cuchillo.....	71	TAKAHASHI pinza.....	165	tijera para el canal de saliva	298
SHAMBAUGH gancho.....	135	tamponador LUNIATSCHEK	292	tijera para tumores.....	207
SHAPLEIGH asa	67	THILENIUS pinza	283	tijera PAR-GREENBERG	202
SHEA cucharilla.....	134	THOMSON-St. CLAIR cuchillo.....	309	tijera PECK-JOSEPH	201
SHEA tijera	80	THUDICHUM espejo nasal	140	tijera PERWITZSCHKY	298
SHEEHAN osteotomo	101, 232	TIECK-HALLE espejo nasal	144	tijera PRINCE	296
SIEGLE espejo auricular	56	tijera	80-83, 115-119, 187-207,	tijera RAGNELL (KILNER).....	191
sierra nasal	244-245	296-299, 343	tijera REYNOLDS (JAMESON)	191
sierra nasal JOSEPH.....	244-245	tijera auricular	80-83	tijera SANVENERO	190
sierra nasal LINDEMANN.....	245	tijera BELLUCCI	80	tijera SCHUKNECHT.....	81
SILVER cincel.....	233	tijera BEUSE.....	201	tijera SHEA	80
SILVER dermatomo.....	221	tijera BOETTCHER.....	296	tijera SPENCER	199
SINUS (LISTER) pinza	155	tijera BONN	192	tijera STANDARD	117
SINUS elevador.....	223	tijera CAPLAN	206	tijera STEVENS.....	196
SINUS sonda.....	261	tijera CONVERSE/WILMER/		tijera STRABISMUS	116, 196
sinuscopio.....	15	WALTER.....	194	tijera UNIVERSAL	118, 299

tijera WAGNER	197	U	WULLSTEIN periostotomo	92
tijera WALTER/CONVERSE/ WILMER	194	UCKERMANN porta-algodon	WULLSTEIN pinza	79
tijera WILMER/CONVERSE/ WALTER	194	UNI I otoscopio	WULLSTEIN separador	113
tijera WULLSTEIN	83	UNI II oftalmoscopio	WULLSTEIN tijera	83
TILLEY pinza	74, 155	UNI III estuche diagnostico	WULLSTEIN-HARTMANN pinza	75, 175
TOBOLD baja-lengua	270	UNIVERSAL lanzapolvo	WULLSTEIN-WEITLANER separador	111
TOYNBEE especulo auricular	53	UNIVERSAL tijera		
transformador	26	V	Y	
trocar COAKLEY	215	VOLKMANN cucharilla	YANKAUER elevador	290
trocar LICHTWITZ	215	VOLTOLINI especulo nasal	YANKAUER tubo de succion	284
trocar para sinoscopia	215	VOSS-KRAUSE polipotomo	YANKAUER-BABY tubo de succion	284
TROELTSCH (WILDE) pinza	94, 152	W	YASARGIL soporte para especulos auriculares	57
TROELTSCH pinza	149	WAGENER gancho	YOUNG pinza	270
TROUSSEAU dilatador	314	WAGENER-MOSHER canula		
TROUSSEAU-BABY dilatador	314	WAGNER tijera	Z	
tubo de aspiracion 125-129, 284, 348		WALSHAM pinza	ZAUFAL elevador	65
tubo de aspiracion BARON	128	WALTER cincel	ZAUFAL-JANSEN elevador	65
tubo de aspiracion EICKEN (KILLIAN)	212	WALTER/CONVERSE/ WALTER tijera	ZAUFAL-JANSEN pinza gubia	107
tubo de aspiracion FERGUSON	213	WATSON dermatomo	ZIEGLER espejo frontal	23
tubo de aspiracion FERGUSON / FRAZIER	125, 213	WATSON-WILLIAMS pinza	ZÖLLNER tubo de aspiracion	125
tubo de aspiracion FRAZIER / FERGUSON	125, 213	WEBER-LOCH asa		
tubo de aspiracion HOUSE	126, 214	WEBSTER porta aguja		
tubo de aspiracion KILLIAN	212	WEBSTER-BABY porta aguja		
tubo de aspiracion KILLIAN (EICKEN)	212	WEIL-BLAKESLEY pinza		
tubo de aspiracion PLESTER	126	WEINGÄRTNER-HARTMANN pinza		
tubo de aspiracion ROSEN	129	WEISS-DUPUY aguja		
tubo de aspiracion ZÖLLNER	125	WEITLANER separador		
tubo de extension BRUENINGS	354	WEITLANER-WULLSTEIN separador		
tubo de silicona	277	WEST cincel		
tubo de succion		WESTMACOTT pinza		
BABY-YANKAUER	284	WHITE pinza		
tubo de succion y coagulacion	211, 348	WIEDER baja-lengua		
tubo de succion YANKAUER	284	WIEN Mod. especulo nasal		
tubo de succion		WIENER escofina		
YANKAUER-BABY	284	WILDE (TROELTSCH) pinza		
TYDING cierranudo	300	WILDE polipotomo		
TYDING pinza	282	WILDER dilatador		
		WILLIAMS-WATSON pinza		
		WILLIGER cucharilla		
		WILLIGER periostotomo		
		WILLIGER separador		
		WILMER/CONVERSE/ WALTER tijera		
		WOOD-CRILE porta aguja		
		WULLSTEIN cuchillo		
		WULLSTEIN mango de succion		

Weitere Kataloge und Prospekte
Other cataloges and prospects

Hauptkatalog Chirurgische Instrumente
General catalog surgical instruments

Arthroskopie
Arthroscopy

Container Steriltechnik
Container Sterilization Technique

Endoskopie
Endoscopy

HERCULES® Drahtkneifzange
HERCULES® Wire Cutters

Plastische Chirurgie
Plastic surgery

Orthopädie
Orthopedic

Titan Instrumente
Titanium Instruments

Neurochirurgie
Neurosurgery
