

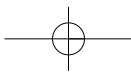

U R O L O G I E

HADEO
INSTRUMENTE GERMANY

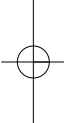

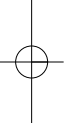
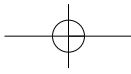

Charrière (Ch) French (F)	Durchmesser in mm	Inches
1	0,33	0,013
2	0,67	0,025
3	1,00	0,039
4	1,33	0,051
5	1,67	0,065
6	2,00	0,0787
7	2,33	0,092
8	2,67	0,105
9	3,00	0,1181
10	3,33	0,131
11	3,67	0,144
12	4,00	0,1575
13	4,33	0,170
14	4,67	0,184
15	5,00	0,1968
16	5,33	0,210
17	5,67	0,223
18	6,00	0,2362
19	6,33	0,249
20	6,67	0,263
21	7,00	0,2756
22	7,33	0,288
23	7,67	0,302
24	8,00	0,3150
25	8,33	0,328
26	8,67	0,341
27	9,00	0,3543
28	9,33	0,367
29	9,67	0,380
30	10,00	0,3973
31	10,33	0,407
32	10,67	0,420
34	11,33	0,446
36	12,00	0,4724
38	12,67	0,494
40	13,33	0,5199
45	15,00	0,5905

Gauge (G)	Durchmesser in mm	Inches
35	0,13	0,005
34	0,18	0,007
33	0,20	0,008
32	0,23	0,009
31	0,25	0,010
30	0,30	0,012
29	0,33	0,013
28	0,36	0,014
27	0,41	0,016
26	0,46	0,018
25	0,51	0,020
	0,53	0,021
24	0,56	0,022
23	0,64	0,025
22	0,71	0,028
21	0,81	0,032
20	0,89	0,035
	0,97	0,038
19	1,07	0,042
18	1,27	0,050
17	1,50	0,059
16	1,65	0,065
15	1,83	0,072
14	2,11	0,083
13	2,41	0,095
12	2,77	0,109
11	3,05	0,120
10	3,40	0,134
9	3,76	0,148
8	4,19	0,165
7	4,57	0,180
6	5,16	0,203

1 OZ	0,028 ml
5 OZ	0,140 ml
16 OZ	0,450 ml

35 OZ	1,0 l
128 OZ	3,7 l

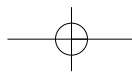

GARANTIE / WARRANTY / GARANTIA / GARANZIA

GARANTIE

Wir gewähren auf alle Hadeo-Instrumente 5 Jahre Garantie. Voraussetzung ist der sach- und fachgerechte Einsatz der Instrumente.
Von der Garantie sind Verschleißerscheinungen ausgeschlossen.

WARRANTY

Our Hadeo products are free from manufacturing defects in material and workmanship. We therefore give on all instruments a guarantee of five years provided that the instruments are maintained and cleaned properly and used normally for their intended purpose.

GARANTIA

Estamos convencidos de nuestra calidad y concedemos a todos los instrumentos de Hadeo 5 años de garantía contra cualquier defecto de fabricación, siempre y cuando se usen adecuadamente.
De la garantía excluimos la manifestación de desgaste.

GARANZIA

Siamo convinti della nostra qualità e concediamo cinque anni di garanzia sulla funzione dei tutti gli strumenti Hadeo sotto la presupposizione che l'utilizzo è da esperto.
Escluso della garanzia sono tracce di consumo.

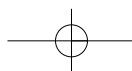

OPTIKEN	7 - 8
TELESCOPES	
ÓPTICAS	
OTTICHE	
<hr/>	
CYSTOSKOPIE	9 - 20
CYSTOSCOPY	
CISTOSCOPIA	
CISTOSCOPIA	
<hr/>	
RESEKTOSKOPIE	21 - 28
RESECTOSCOPY	
RESECTOSCOPIA	
RESETTOSCOPIA	
<hr/>	
URETHROTOM	29 - 32
URETHROTOME	
URETRÓTOMO	
URETROTOMO	
<hr/>	
CYSTOSKOPIE FÜR 2,9 MM Ø OPTIK	33 - 38
CYSTOSCOPY FOR 2,9 MM Ø OPTIC	
CISTOSCOPIA PARA ÓPTICA 2,9 MM Ø	
CISTOSCOPIA PER OTTICA 2,9 MM Ø	
<hr/>	
RESEKTOSKOPIE FÜR 2,9 MM Ø OPTIK	39 - 46
RESECTOSCOPY FOR 2,9 MM Ø OPTIC	
RESECTOSCOPIA PARA ÓPTICA 2,9 MM Ø	
RESETTOSCOPIA PER OTTICA 2,9 MM Ø	
<hr/>	
URETHROTOMIE FÜR 2,9 MM Ø OPTIK	47 - 50
URETHROTOMY FOR 2,9 MM Ø OPTIC	
URETRÓTOMO PARA ÓPTICA 2,9 MM Ø	
URETROTOMO PER OTTICA 2,9 MM Ø	
<hr/>	
PÄDIATRISCHE UROLOGIE / CYSTOSKOPIE UND RESEKTOSKOPIE, 9,5 & 11 CHAR Ø	51 - 56
PEDIATRIC UROLOGY / CYSTOSCOPY AND RESECTOSCOPY, 9,5 & 11 FR. Ø	
UROLOGÍA PEDIÁTRICA / CISTOSCOPIA Y RESECTOSCOPIA, 9,5 & 11 CHAR Ø	
UROLOGIA PEDIATRICA / CISTOSCOPIA E RESETTOSCOPIA, 9,5 & 11 CHAR Ø	

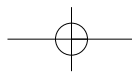

PÄDIATRISCHE UROLOGIE / CYSTOSKOPIE UND RESEKTOSKOPIE, 13 CHAR Ø	57 - 62
PEDIATRIC UROLOGY / CYSTOSCOPY AND RESECTOSCOPY, 13 FR. Ø	
UROLOGÍA PEDIÁTRICA / CISTOSCOPIA Y RESECTOSCOPIA, 13 CHAR Ø	
UROLOGIA PEDIATRICA / CISTOSCOPIA E RESECTOSCOPIA, 13 CHAR Ø	

NEPHROSKOPIE	63 - 66
NEPHROSCOPY	
NEFROSCOPIA	
NEFROSCOPIA	

URETERO-RENOSKOPIE	67 - 72
URETERO-RENOSCOPY	
URETERO-RENOSCOPIA	
URETERO-RENOSCOPIA	

ZUBEHÖR	73 - 78
ACCESSORIES	
ACCESORIOS	
ACCESSORI	

NUMMERNVERZEICHNIS	79 - 81
NUMERICAL INDEX	
INDICE NUMÉRICO	
INDICE NUMERICO	

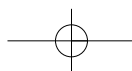

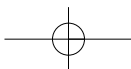

OPTIKEN

TELESCOPES

ÓPTICAS

OTTICHE

HADEO
INSTRUMENTE GERMANY

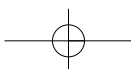

Cystoskope 302 mm Nutzlänge, integrierte Fiberoptik Faser für Beleuchtung, autoklavierbar
Cystoscopes 302 mm working length, incorporated fiber optic bundle for illumination, autoclavable
Cistoscopio 302 mm longitud, con conductor de luz de fibra, esterilizable e autoclavable
Optica Cistoscopio lunghezza utile 302 mm a vision con conduttore di luce a fibre ottiche



Blickrichtung
Angle of view
Dirección visual
Angolo di visione

Ø 4,0 mm

0°	R300-040302-000
15°	R300-040302-015
30°	R300-040302-030
70°	R300-040302-070

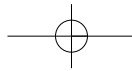

CYSTOSKOPIE

CYSTOSCOPY

CISTOSCOPIÁ

CISTOSCOPIA



Cystoskop-Schäfte, 2 Hähne fest mit LL-Adapter
 Cystoscopy sheaths, 2 stop cocks fixed with LL-adapters
 Camisas para cistoscopio, 2 valvas nrigidas adaptador de LL
 Camicia per cistoscopio, 2 rubinetti fissi con adattatore LL

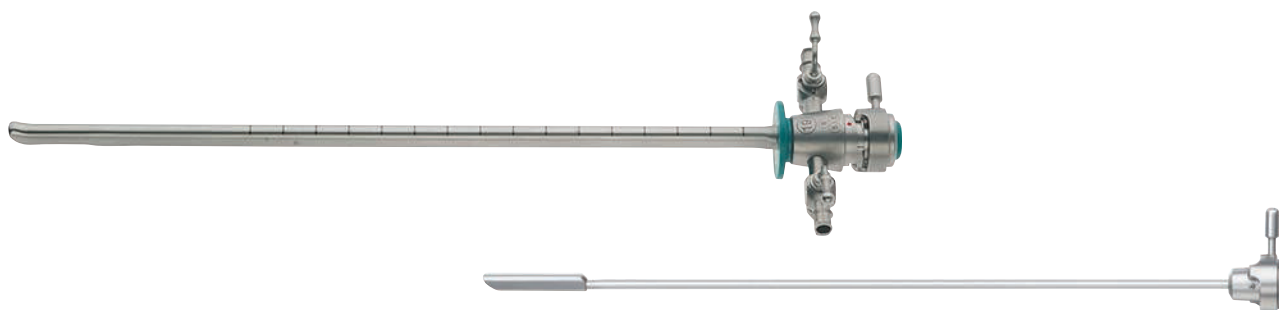

Ø [Char]	Obturator	Sheath	Sheath + Obturator	Colour Code
17	R310-170000-001	R310-170235-001	R311-170235-001	Yellow
19	R310-190000-001	R310-190235-001	R311-190235-001	Green
21	R310-210000-001	R310-210235-001	R311-210235-001	Red
23	R310-230000-001	R310-230235-001	R311-230235-001	Blue
25	R310-250000-001	R310-250235-001	R311-250235-001	White



	Ø [Char]	
Sichtobturator für Cystoskopschaft	17	R310-170000-003
Visual obturator for cystoscope sheath	19	R310-190000-003
Obturador visual para camisa de cistoscopio	21	R310-210000-003
Otturatore di visualizzazione	23	R310-230000-003
	25	R310-250000-003

Cystoskop-Schaft, Zentralhahn mit LL-Adapter
 Cystoscopy sheath, central valve fixed with LL-adapters
 Camisas para cistoscopio, valvula central con adaptador de LL
 Camicia cistoscopio, 2 rubinetti fissi dotato di rubinetto centrale con ingresso LL



Ø [Char]	Obturator	Sheath	Sheath + Obturator	Colour Code
17	R310-170000-001	R312-170235-001	R313-170235-001	Yellow
19	R310-190000-001	R312-190235-001	R313-190235-001	Green
21	R310-210000-001	R312-210235-001	R313-210235-001	Red
23	R310-230000-001	R312-230235-001	R313-230235-001	Blue
25	R310-250000-001	R312-250235-001	R313-250235-001	White

Cystoskopie - Optikbrücken Ø 4 mm
Cystoscopy - Telescope bridges Ø 4 mm
Cistoscopia - Puente para optica de Ø 4 mm
Cistoscopio - Ponticello Ø 4 mm



R310-040000-000

Optikbrücke für Diagnose
Telescope bridge for diagnostic
Puente para optica para el diagnostico
Ponticello diagnostico per visione diretta

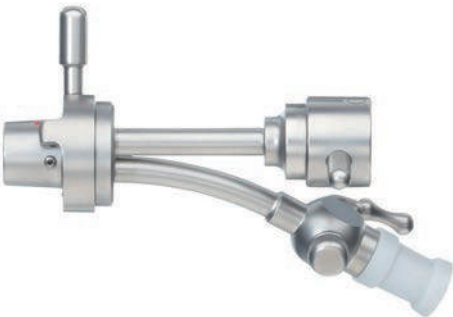

R310-040000-001

Optikbrücke mit 1 Instrumentenkanal verschließbar
Telescope bridge with 1 instrument channel lockable
Puente para optica con 1 canal obturable para instrumental
Ponticello diagnostico con 1 ingresso



R310-040000-002

Optikbrücke mit 2 Instrumentenkanal verschließbar
Telescope bridge with 2 instrument channel lockable
Puente para optica, con 2 canales obturables para instrumental
Ponticello diagnostico con 2 ingressi

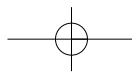

HADEO
INSTRUMENTE GERMANY

Cystoskopie - Arbeitseinsatz mit Albarran-Lenkhebel
Cystoscopy - Working-element with Albarran deflector
Cistoscopia - vaina de trabajo con palanca conductor tipo Albarran
Cistoscopio - Inserto operativo con leva di ALBARRAN

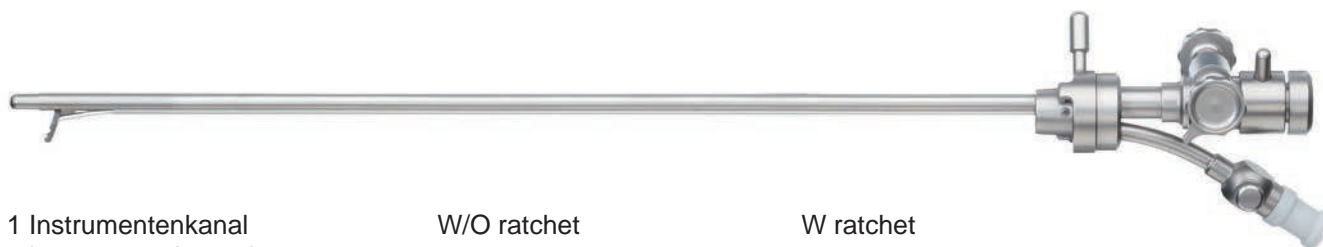

1 Instrumentenkanal
1 instrument channel
1 canal para instrumentos
1 canale per strumenti

W/O ratchet
R310-040000-011

W ratchet
R310-040000-021

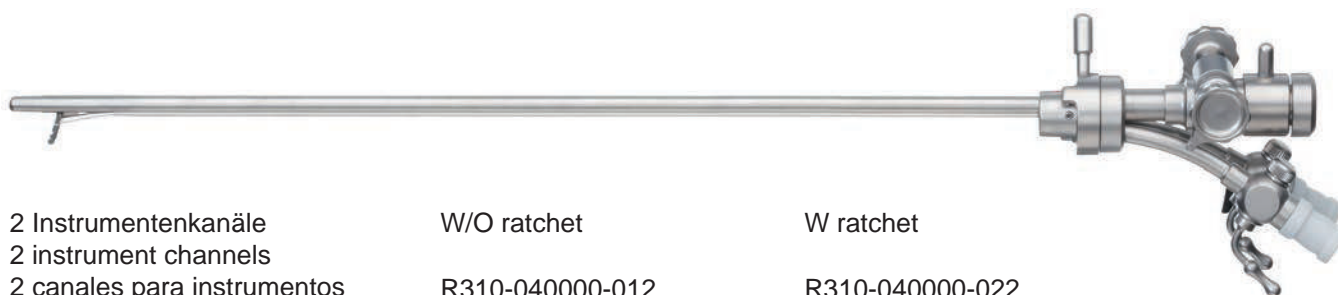

2 Instrumentenkanäle
2 instrument channels
2 canales para instrumentos
2 canali per strumenti

W/O ratchet
R310-040000-012

W ratchet
R310-040000-022



NICKELL Cystoskop Adapter für Frauen
NICKELL cystoscope adapter for women
NICKELL adaptador cistoscopico para mujeres
NICKELL adattatore per donne

R319-900-01

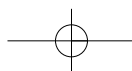

Optische Instrumente für Cystoskopschäfte ab 21 Char Ø
 Optical instruments suitable for cystoscope sheath up on 21 Char Ø
 Instrumental optico para vainas cistoscópicas de 21 Char Ø
 Instrumenti ottici per camicia cistoscopica 21 Char Ø



Biopsiezange
 Biopsy forceps
 Pinza biopsia
 Pinza per biopsia

R315-021000-01



Biopsiestanze
 Biopsy punch
 Pinza biopsia
 Pinza tagliente per biopsia

R315-021000-06



Schere
 Scissor
 Tijera
 Forbici

R315-021000-021



Faßzange
 Grasping forceps
 Pinza de agarre
 Pinza per presa

R315-021000-011

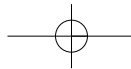

Optische Instrumente für Cystoskopschäfte ab 21 Char Ø
 Optical instruments suitable for cystoscope sheath up on 21 Char Ø
 Instrumental optico para vainas cistoscópicas de 21 Char Ø
 Instrumenti ottici per camicia cistoscopica 21 Char Ø

Probeexzisionszange, optisch
 Biopsy punch, optical
 Pinza de biopsia, óptica
 Pinza per biopsia con canale per ottica



30° R315-021000-30

70° R315-021000-70

Adapter f. Resektoskop Schäfte
 Adaptor f. resectoscope sheath
 Adaptador para vainas resectoscópicas
 Adattatore per camicie resettoscopio



R315-901

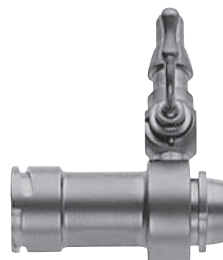



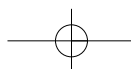

R315-902









Flexible Instrumente 40 cm
 Flexible instruments 40 cm
 Instrumentos flexible 40 cm
 Instrumenti Flessibili 40 cm

Nutzlänge von 34 cm auf Anfrage erhältlich
 Length of 34 cm available on request
 Largo util de 34 cm disponible a petición
 Lunghezza utile 34 cm disponibile su richiesta

	Ø 5 [Char]	Ø 6 [Char]	Ø 7 [Char]	Ø 9 [Char]
 <p>Biopsiezange Bopsy forceps Pinza de biopsia Pinza per biopsia con doppia articolazione</p>	R392-017400-001	R392-021400-001	R392-023400-001	R392-030400-001
 <p>Löffel gezahnt Foreign body, short Cuchara dentada Pinza per la rimozione con doppia articolazione</p>	R392-017400-003	R392-021400-003	R392-023400-003	R392-030400-003
 <p>Biopsiezange einfachbeweglich Bopsy punch single action Pinza para biopsia articulacion simple Pinza per biopsia mono articolata</p>			R392-023400-004	
 <p>Löffel oval Spoon Forceps Cuchara oval Cucchiaino ovale con denti aggressivi</p>	R392-017400-005	R392-021400-005	R392-023400-005	
 <p>Fasszange Grasping forceps Pinza de agarre Pinza da presa con doppia articolazione</p>		R392-021400-006		
 <p>Fremdkörperzange Foreign body forceps Pinza para cuerpos extraños Pinza da presa per corpi estranei, mono articolata</p>			R392-023400-009	

Flexible Instrumente 40 cm
 Flexible instruments 40 cm
 Instrumentos flexible 40 cm
 Instrumenti Flessibili 40 cm

 Nutzlänge von 34 cm auf Anfrage erhältlich
 Length of 34 cm available on request
 Largo util de 34 cm disponible a petición
 Lunghezza utile 34 cm disponibile su richiesta

	Ø 5 [Char]	Ø 6 [Char]	Ø 7 [Char]	Ø 9 [Char]
 <p>Fremdkörper-Zange Foreign body forceps Pinza para cuerpos extraños Pinza da presa per corpi estranei con doppia articolazione</p>			R392-023400-010	
 <p>Alligatorfaßzange Alligator grasping forceps Pinza de agarre tipo caiman Pinza da presa tipo alligator con doppia articolazione</p>	R392-017400-011	R392-021400-011	R392-023400-011	R392-030400-011
 <p>Steinzange Stone grasping forceps Pinza para calculus Pinza da presa per calculi con doppia articolazione</p>			R392-023400-014	
 <p>Schere Scissor Tijera Forbici mono articolata</p>	R392-017400-021	R392-021400-021	R392-023400-021	R392-030400-021
 <p>Schere doppelt beweglich Scissor, double action Tijera, articulacion doble Forbici con doppia articolazione, lama seghettata</p>			R392-023400-022	
 <p>Hakenschere Hook scissor Tijera en forma de gancho Forbici rette uncinata mono articolate</p>			R392-023400-023	R392-030400-023

Dormia Steinfänger
 Dormia stone dislodger
 Malla para rescadar calculus
 Cestello dormia



R394-017600-004

4 Drähte, 5 Char Ø, 600 mm Nutzlänge
 4 wires, 5 Fr. Ø, 600 mm work.length
 Extractor de calculus de 4 alambres 5 Char Ø, 600 mm de largo util
 Cestello dormia 4 filamenti, lunghezza 600 mm

R394-017600-006



6 Drähte, 5 Char Ø, 600 mm Nutzlänge
 6 wires, 5 Fr. Ø, 600 mm work.length
 Extractor de calculus de 6 alambres 5 Char Ø, 600 mm de largo util
 Cestello dormia 6 filamenti, lunghezza 600 mm



R394-000000-000

Griff für Dormia Steinfänger
 handle for Dormia stone dislodger
 mango para Malla para rescadar calculus
 Impugnatura per Cestello dormia

Koagulationselektroden, flexibel
 Coagulation electrodes, flexible
 Electrodo para coagulación, flexible
 Elettrodo per coagulazione, flessibile

	Ø 3 [Char]	Ø 5 [Char]	Ø 7 [Char]	Ø 9 [Char]
 Knopf Ball end Bola Sfera	R395-010450-001	R395-017450-001	R395-023450-001	R395-030450-001
 Nadel Needle type Aguja Ago	R395-010450-021	R395-017450-021	R395-023450-021	
 Schlinge Loop Asa Ansa		R395-017450-011	R395-023450-011	R395-030450-011

Polypektomie-Schlinge
 Polypectomy loop
 Asa para polipectomia
 Ansa per polipectomia



Ø 5 [Char]
 R395-017400-125

Ø 7 [Char]
 R395-023400-125

Handgriff mit HF Anschluß für Diathermie Schlinge
 Handle w. HF connector for diathermy loop
 Mango con conexión de alta frecuencia para asa de diatermia
 Impugnatura per diatermia con cursore ad anello dotata di attacco monopolare



R395-000000-000

Lithotripsie
 Lithotripsy
 Litotripsia
 Litotripsia



R315-250000-39 (for 25 Char)

Steinzange
 Stone grasping forceps
 Pinza para cálculo
 Pinza per calcoli

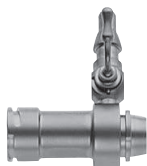

R315-902

Adapter für Steinzange
 Adapter for grasping forceps
 Adaptador para el uso de la pinza para cálculo
 Adattore con rubinetto per l'uso delle pinze per calcoli

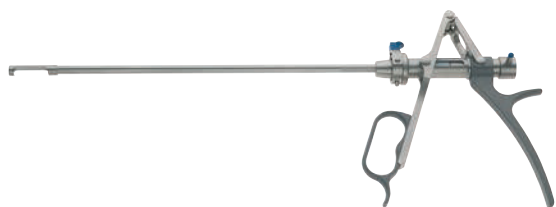

R315-240000-59

Arbeitselement zur Stanz-Lithotripsie; optisch, 24 Char
 Working element for punch lithotripsy; optical, 24 Fr.
 Element de trabajo para litotripsia; óptico, 24 Char
 Strumento ottico, 24 Char di lavoro operativo per litotripsia



R313-240235-001

Lithotripsie Schaft mit Zentralhahn 24 Char
 Lithotripsy sheath with central valve, 24 Fr.
 Vaina para litotripsia con llave central, 24 Char
 Camicia per litotripsia con rubinetto centrale, 24 Char



R310-240000-001

Obturator Standard; für Lithotripsie Schaft 24 Char
 Obturator standard; for lithotripsy sheath 24 Fr.
 Obturador estándar; para vaina de litotripsia 24 Char
 Otturatore standard; per camicia litotriptisia 24 Char



R312-240000-001

Optikbrücke mit 1 Instrumentenkanal 24 Char
 Telescope bridge; 1 instrument channel 24 Fr.
 Puente óptico; 1 canal para instrumentos 24 Char
 Ponte per telescopio con 1 canale per strumenti 24 Char

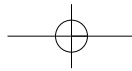

RESEKTOSKOPIE

RESECTOSCOPY

RESECTOSCOPIA

RESECTOSCOPIA

HADEO
INSTRUMENTE GERMANY

Arbeitselement für Ø 4 mm Optik
 Working element for Ø 4 mm optic
 Elemento de trabajo para óptica Ø 4 mm
 Elemento di lavoro per l'uso con ottica Ø 4 mm

"AKTIV", schneidend durch Fingerdruck
 "ACTIVE", cutting by finger action
 "ACTIVO", cortante por la presión del dedo
 Impugnatura con movimento "ATTIVO"

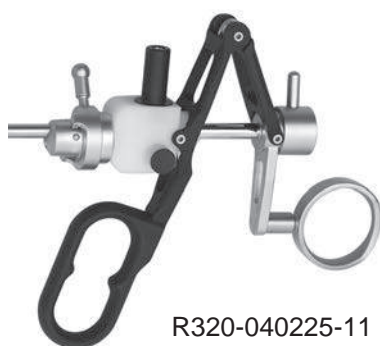

R320-040225-11

Griff geschlossen
 Closed handle
 Mango cerrado
 Manico con anello chiuso

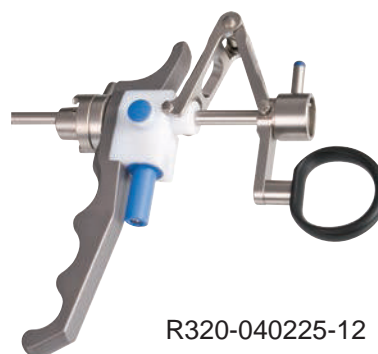

R320-040225-12

Griff offen
 Opened handle
 Mango abierto
 Manico aperto

Arbeitselement "PASSIV", schneiden durch Federzug
 Working element "PASSIVE", cutting by spring action
 Elemento de trabajo "PASSIVO", cortante por balancin
 Elemento di lavoro con movimento "PASSIVO"



R320-040225-01

Griff geschlossen
 Closed handle
 Mango cerrado
 Manico con anello chiuso



R320-040225-02

Griff offen
 Opened handle
 Mango abierto
 Manico aperto

Hochfrequenzkabel, monopolar, für Geräte von:
 High frequency cable, monopolar, for devices of:
 Cable monopolar de alta frecuencia, para equipos de:
 Cavo monopolare ad alta frequenza per apparecchi:



4 mm

Eschmann alte Gerät, Erbe T-Serie old units
 R329-040000-003 3 mtr.
 R329-040000-005 5 mtr.



4 mm

Aesculap, Berchtold, Martin
 R329-040000-203 3 mtr.
 R329-040000-205 5 mtr.



5 mm

Erbe, Storz
 R329-050000-003 3 mtr.
 R329-050000-005 5 mtr.



8 mm

Valleylab
 R329-080000-003 3 mtr.
 R329-080000-005 5 mtr.

Dauerspül Resektoskop-Schäfte
 Resectoscope sheats, continuous flow
 Vaina para resectoscopio con flujo continuo
 Camicia resettore, a aspirazione continua



Ø [Char]

Innenschaft, ohne Spülhahn mit LL-Adapter
 Inner Sheat, without irrigation stop cock with LL-adapter
 Vaina interior, valvula de irrigacion sin adaptador de LL
 Camicia interna, attacco LL senza rubinetto fisso

24	Drehbar Rotatable rotable	R320-240000-130
	Nicht drehbar Not rotatable non rotatable	R320-240000-030

27	Drehbar Rotatable rotable	R320-270000-130
	Nicht drehbar Not rotatable non rotatable	R320-270000-030

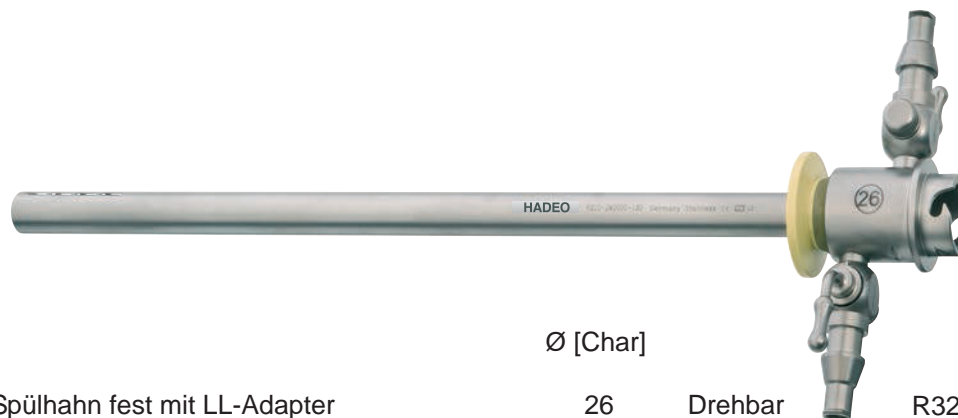

Ø [Char]

Außenschaft, 2 Spülhahn fest mit LL-Adapter
 Outer Sheat, 2 irrigation stop cock with LL-adapter
 Vaina exterior, 2 valvula de irrigacion con adaptador de LL
 Camicia esterna, attacco LL con 2 rubinetti fissi

26	Drehbar Rotatable rotable	R320-260000-130
	Nicht drehbar Not rotatable non rotatable	R320-260000-030

28,5	Drehbar Rotatable rotable	R320-285000-130
	Nicht drehbar Not rotatable non rotatable	R320-285000-030

Dauerspül Resektoskop-Schäfte
 Resectoscope sheats, continuous flow
 Vaina para resectoscopio con flujo continuo
 Camicia resettore, a aspirazione continua



	Ø [Char]		
Kombinierte Schäfte Combi sheats Vainas combinadas Camicia con combinazione	24 / 26	Drehbar Rotatable rotabile	R320-260240-130
		Nicht drehbar Not rotatable non rotabile	R320-260240-030
	27 / 28,5	Drehbar Rotatable rotabile	R320-285270-130
		Nicht drehbar Not rotatable non rotabile	R320-285270-030

Resektoskopie Obturatoren
 Resectoscopy obturators
 Obturador para resectoscopia
 Otturatori per resettoscopia



Standard Obturator	Ø [Char]		
Standard obturators	24		R320-240000-001
Obturador estandar	27		R320-270000-001
Standard otturatore			







Obturator, krümmbar	Ø [Char]		
Obturator deflectable	24		R320 240000-002
Obturador flexible	27		R320-270000-002
Otturatore mono aticolato			







Sicht-Obturatot	Ø [Char]		
Visual Obturator	24	ohne Kanal without channel sin canal	R320-240000-003
Obturador visual		mit Kanal with channel con canal	R320-240000-005
Otturatore diagnostico per visualizzazione diretta			
	27	ohne Kanal without channel sin canal	R320-270000-003
		mit Kanal with channel con canal	R320-270000-005

Monopolare Elektroden
 Monopolar electrodes
 Electrodo monopolar
 Elettrodo monopolare

		Ø 24 [Char]	Ø 27 [Char]
	Schlinge retrograde gebogen Loop, retrograde curved Electrodo de asa, curva retrogradamente Ansa per taglio, angolata	R329-240000-001 (for 0° Optic) R329-240030-001 (for 30° Optic)	R329-270000-001 (for 0° Optic) R329-270030-001 (for 30° Optic)
	Schlinge gerade Loop, straight Asa recta Ansa per taglio, ad asso longitudinale	R329-240010-001	R329-270010-001
	Kugel Ball Bola sferico	R329-240040-003 (Ø 3 mm) R329-240040-005 (Ø 5 mm)	R329-270040-003 (Ø 3 mm) R329-270040-005 (Ø 5 mm)
	Rolle Roller barrel Rollo Rullo	R329-240050-003 (Ø 3 mm) R329-240050-005 (Ø 5 mm)	R329-270050-003 (Ø 3 mm) R329-270050-005 (Ø 5 mm)
	Vaporisationsschlinge Vaporisation Loop Asa de vaporisacion Elettrodo per vaporizzazione	R329-240055-001 (for 0° Optic) R329-240056-001 (for 30° Optic)	R329-270055-001 (for 0° Optic)

Monopolare Elektroden
 Monopolar electrodes
 Electrodo monopolar
 Elettrodo monopolare

		Ø 24 [Char]	Ø 27 [Char]
	Vaporisationselektrode Vaporisation electrode Electrodo de vaporizacion Elettrodo a rullo per vaporizzazione	R329-240052-003 (Ø 3 mm)	R329-270052-003 (Ø 3 mm)
		R329-240052-005 (Ø 5 mm)	R329-270052-005 (Ø 5 mm)
	Spike Spike electrode Electrodo de Spike Elettrodo di Spike	R329-240054-003 (Ø 3 mm)	
		R329-240054-005 (Ø 5 mm)	
	Kegel Cone Cono Conico	R329-240090-003	
	Messer Knife Cuchillo Elettrodo di coagulazione a bisturi	R329-240070-001	R329-270070-001

R329-990



Sterilisierhülse für Elektroden
 Sterilization tube for electrodes
 Embudo para esterilizacion de electrodo
 Tubo di protezione per elettrodi

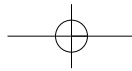

URETHROTOM

URETHROTOME

URETRÓTOMO

URETROTOMO



Urethrotomie
 Urethrotomy
 Uretrotomia
 Uretrotomia

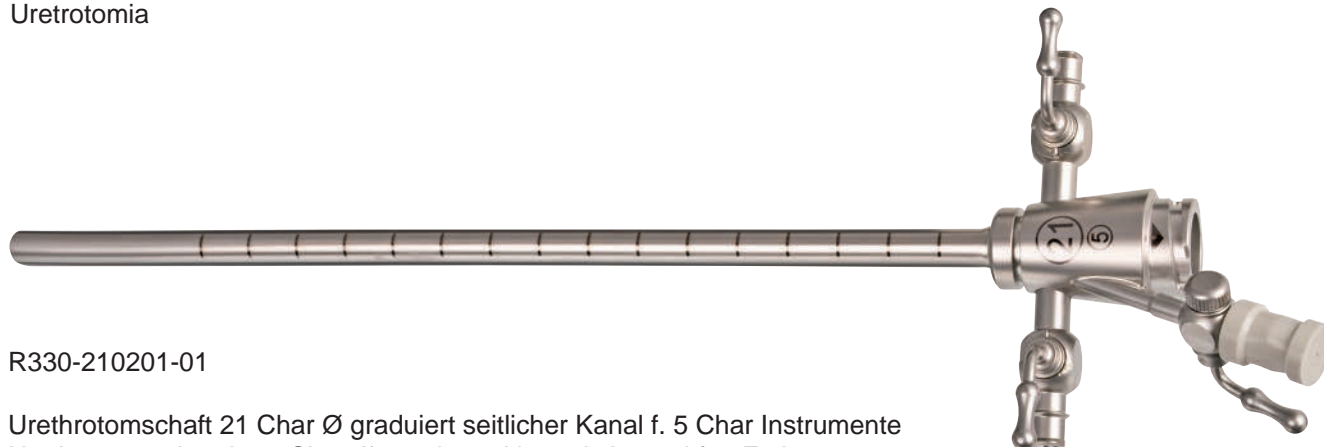

R330-210201-01

Urethrotomschaft 21 Char Ø graduiert seitlicher Kanal f. 5 Char Instrumente
 Urethrotome sheath 21 Char Ø, graduated lateral channel f. 5 Fr. Instruments
 Vaina para uretrotomo de 21 Char Ø con canal graduado lateral para instrumentos de 5 Char
 Camicia per uretrotomo 21 Char Ø



R330-230201-001

Zusatzschaft für Urethrotom, seitlich offen
 Supplementary sleeve, lateral open
 Vaina adicional para uretrotomo, apertura lateral
 Camicia supplementare, aperta lateralmente



R330-230201-102

Dauerspül Zusatzschaft für Urethrotomschaft 21 Char Ø
 Continuous Flow supplementary sleeve for urethrotom-sleeve 21 Char Ø
 Vaina adicional para irrigación continua para uretrotomo de 21 Char Ø
 Camicia supplementare a lavaggio continuo 21 Char Ø per camicia per uretrotomo

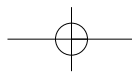

HADEO
INSTRUMENTE GERMANY

Urethrotomie
Urethrotomy
Uretrotomia
Uretrotomia



R330-210000-01

Urethrotom Standard Obturator für 21 Char Ø Schaft #R330-210201-01
Urethrotome standard obturator for 21 Char Ø sheath #R330-210201-01
Obturador estándar para uretrótomo de 21 Char Ø vaina #R330-210201-01
Otturatore, per camicia per uretrotomo, 21 Char Ø #R330-210201-01



R330-210000-11

Urethrotom Standard Obturator für 21 Char Ø mit Arbeitskanal
Urethrotome standard obturator for 21 Char Ø with instrument channel
Obturador estándar para uretrótomo de 21 Char Ø con 1 canal para instrumentos
Otturatore, per camicia per uretrotomo, 21 Char con 1 canale operative per strumenti

R339-040000-001

Optikbrücke
Telescope bridge
Puente para optica
Ponticello per uretrotomo

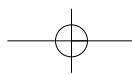
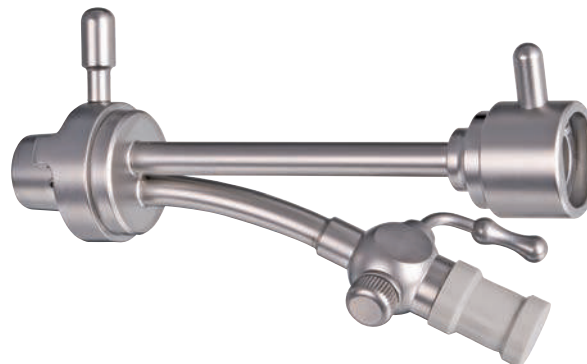

Strikturmesser
Cold knife
Cuchillo de corte frio
Lama uretrotomo per taglio a freddo



R339-210000-001
gerade
straight
recto
retto



R339-210000-002
Wellenschliff
wave shaped
filo ondulado
affilatura ondulata



R339-210000-011
rund
round shaped
semicircular
semisferico



R339-210000-021
ringförmig
ring shaped
en forma de anillo
ad anello



R339-210000-031
sichelförmig
sickle shaped
en forma de hoz
ad uncino

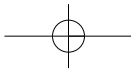

CYSTOSKOPIE
für 2,9 mm Ø Optik

CYSTOSCOPY
for 2,9 mm Ø optic

CISTOSCOPIÁ
para óptica 2,9 mm Ø

CISTOSCOPIA
per ottica 2,9 mm Ø

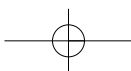

Cystoskope 302 mm Nutzlänge, integrierte Fiberoptik Faser für Beleuchtung, autoklavierbar
Cystoscopes 302 mm working length, incorporated fiber optic bundle for illumination, autoclavable
Cistoscopio 302 mm longitud, con conductor de luz de fibra, esterilizable e autoclavable
Cistoscopio lunghezza utile 302 mm, con conduttore di luce a fibre ottiche sterilizzabile in autoclave



Blickrichtung
Angle of view
Dirección visual
Angolo di visione

Ø 2,9 mm

0°	R300-029302-000
15°	R300-029302-015
30°	R300-029302-030
70°	R300-029302-070

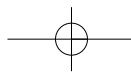
**HADEO**
INSTRUMENTE GERMANY

Cystoskop-Schäfte
Cystoscopy sheaths
Camisas para cistoscopio
Camicie per cistoscopio



Ø [Char] 15

Cystoskop-Schaft, 2 Hähne fest mit LL-Adapter
Cystoscopy sheath, 2 stop cocks fixed with LL-adapters
Camisa para cistoscopio, 2 valvulas con adaptador de LL
Camicia cistoscopio, 2 rubinetti fissi incluso, 2 coni LL

Obturator	R310-150000-001
Sheath + Obturator	R310-150235-001
Sheath	R311-150235-001

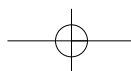

Cystoskopie - Optikbrücken
Cystoscopy - Telescope bridges
Cistoscopia - Puente para optica
Cistoscopio - Ponticello



R310-029000-000

Optikbrücke für Diagnose
Telescope bridge for diagnostic
Puente para optica para el diagnostico
Ponticello diagnostico per visione diretta

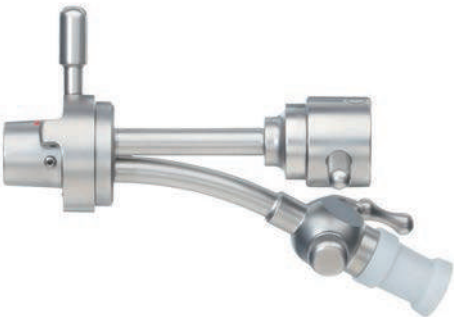

R310-029000-001

Optikbrücke mit 1 Instrumentenkanal verschließbar
Telescope bridge with 1 instrument channel lockable
Puente para optica con 1 canal obturable para instrumental
Ponticello diagnostico con 1 canale



R310-029000-002

Optikbrücke mit 2 Instrumentenkanal verschließbar
Telescope bridge with 2 instrument channel lockable
Puente para optica con 2 canales obturables para instrumental
Ponticello diagnostico con 2 canali

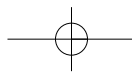
**HADEO**
INSTRUMENTE GERMANY

Cystoskopie - Arbeitseinsatz mit Albarran-Lenkhebel
Cystoscopy - Working-element with Albarran deflector
Cistoscopia - vaina de trabajo con palanca conductor tipo Albarran
Cistoscopio - Inserto operativo con leva di ALBARRAN



R310-029000-011

Arbeitseinsatz mit Albarran-Lenkhebel, 1 Instrumentenkanal
Working-element with Albarran deflector, 1 instrument channel
Vaina de trabajo con palanca conductora tipo Albarran, 1 canal para instrumental
Inserto operativo con leva di ALBARRAN con 1 ingresso



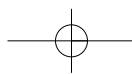

R310-029000-012

Arbeitseinsatz mit Albarran-Lenkhebel, 2 Instrumentenkanäle
Working-element with Albarran deflector, 2 instrument channels
Vaina de trabajo con palanca conductora tipo Albarran, 2 canales para instsrumental
Inserto operativo con leva di ALBARRAN con 2 ingressi



Flexible Instrumente 40 cm
 Flexible instruments 40 cm
 Instrumentos flexible 40 cm
 Instrumenti Flessibili 40 cm

Nutzlänge von 34 cm auf Anfrage erhältlich
 Length of 34 cm available on request
 Largo util de 34 cm disponible a petición
 Lunghezza utile 34 cm disponibile su richiesta

	Ø 5 [Char]	Ø 4 [Char]	Ø 3,5 [Char]	Ø 3 [Char]
 <p>Biopsiezange Biopsy forceps Pinza de biopsia Pinza per biopsia con doppia articolazione</p>	R392-017400-001	R392-014400-001	R392-012400-001	R392-010400-001
 <p>Löffel oval Spoon Forceps Cuchara oval Cucchiaino ovale con denti aggressivi</p>	R392-017400-005			R392-010400-005
 <p>Alligatorfaßzange Alligator grasping forceps Pinza de agarre tipo caiman Pinza da presa tipo alligator con doppia articolazione</p>	R392-017400-011	R392-014400-011	R392-012400-011	R392-010400-011
 <p>Schere Scissor Tijera Forbici mono articolata</p>	R392-017400-021	R392-014400-021	R392-012400-021	R392-010400-021

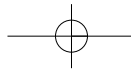

RESEKTOSKOPIE
für 2,9 mm Ø Optik

RESECTOSCOPY
for 2,9 mm Ø optic

RESECTOSCOPIÁ
para óptica 2,9 mm Ø

RESETTOSCOPIA
per ottica 2,9 mm Ø

HADEO
INSTRUMENTE GERMANY

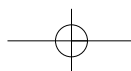

Arbeitselement für Ø 2,9 mm Optik
 Working element for Ø 2,9 mm optic
 Vaina de trabajo para óptica de Ø 2,9 mm
 Elemento di lavoro per ottico Ø 2,9 mm

"AKTIV", schneidend durch Fingerdruck
 "ACTIVE", cutting by finger action
 "ACTIVO", cortante por la presión del dedo
 impugnatura con movimento "ATTIVO"



R320-027225-11

Griff geschlossen
 Closed handle
 Mango cerrado
 Manico con anello chiuso

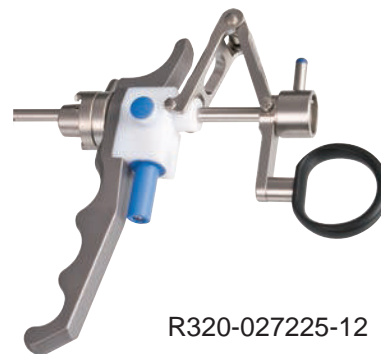

R320-027225-12

Griff offen
 Opened handle
 Mango abierto
 Manico aperto

Arbeitselement "PASSIV", schneiden durch Federzug
 Working element "PASSIVE", cutting by spring action
 Elemento de trabajo "PASSIVO", cortante por balancin
 Elemento di lavoro con movimento "PASSIVO"



R320-027225-01

Griff geschlossen
 Closed handle
 Mango cerrado
 Manico con anello chiuso



R320-027225-02

Griff offen
 Opened handle
 Mango abierto
 Manico aperto

Hochfrequenzkabel, monopolar, für Geräte von:
 High frequency cable, monopolar, for devices of:
 Cable monopolar de alta frecuencia, para equipos de:
 Cavo monopolare ad alta frequenza per apparecchi:



4 mm

Eschmann alte Gerät, Erbe T-Serie old units
 R329-040000-003 3 mtr.
 R329-040000-005 5 mtr.



4 mm

Aesculap, Berchtold, Martin
 R329-040000-203 3 mtr.
 R329-040000-205 5 mtr.



5 mm

Erbe, Storz
 R329-050000-003 3 mtr.
 R329-050000-005 5 mtr.



8 mm

Valleylab
 R329-080000-003 3 mtr.
 R329-080000-005 5 mtr.

Dauerspül Resektoskop-Schäfte
 Resectoscope sheats, continuous flow
 Vaina para resectoscopio con flujo continuo
 Camicia resettore, a aspirazione continua



Ø [Char]

Innenschaft, 1 Spülhahn fest mit LL-Adapter
 Inner Sheat, 1 irrigation stop cock with LL-adapter
 Vaina interior, 1 valvula de irrigacion rigida con adaptador de LL
 Camicia interna, con 1 Rubinetto ingresso LL

19

Drehbar
 Rotatable
 rotatable

R320-190000-130

Nicht drehbar
 Not rotatable
 non rotatable

R320-190000-030

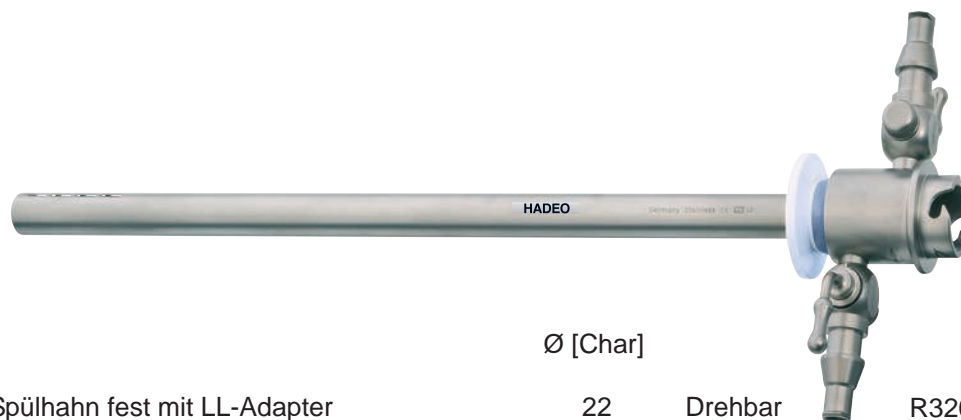

Ø [Char]

Außenschaft, 1 Spülhahn fest mit LL-Adapter
 Outer Sheat, 1 irrigation stop cock with LL-adapter
 Vaina exterior, 1 valvula de irrigacion rigida con adaptador de LL
 Camicia esterna, con 1 rubinetto ingresso LL

22

Drehbar
 Rotatable
 rotatable

R320-220000-130

Nicht drehbar
 Not rotatable
 non rotatable

R320-220000-030

Dauerspül Resektoskop-Schäfte
 Resectoscope sheats, continuous flow
 Vaina para resectoscopio con flujo continuo
 Camicia resettore, a aspirazione continua



Ø [Char]

Kombinierte Schäfte

Combi sheats

Vainas combinadas

Camicia con combinazione

19 / 22

Drehbar

Rotatable

rotable

R320-220190-130

Nicht drehbar

Not rotatable

non rotabile

R320-220190-030

Resektoskopie Obturatoren
 Resectoscopy obturators
 Obturadores para resectoscopia
 Otturatori per resettoscopia



Standard Obturator
 Standard obturators
 Obturador estandar
 Standard otturatore

Ø [Char]
 19

R320-190000-001



Sicht-Obturatot
 Visual Obturator
 Obturador visual
 Otturatore diagnostico per visualizzazione diretta

Ø [Char]
 19



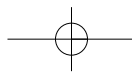

ohne Kanal
 without channel
 sin canal

R320-190000-003



HADEO
INSTRUMENTE GERMANY

Monopolare Elektroden
Monopolar electrodes
Electrodos monopolares
Elettrodo monopolare

	<p>Schlinge retrograde gebogen Loop, retrograde curved Asa, curva retrogradamente Ansa per taglio, angolata</p>	<p>Ø 19 [Char] R329-190000-001 (for 0° Optic) R329-190030-001 (for 12° Optic)</p>
	<p>Kugel Ball Bola Sferico</p>	<p>R329-190040-002 (Ø 2 mm) R329-190040-003 (Ø 3 mm)</p>
	<p>Rolle Roller barrel Rollo Rullo</p>	<p>R329-190050-003 (Ø 3 mm)</p>
	<p>Messer Knife Cuchillo Elettrodo di coagulazione a bisturi</p>	<p>R329-190070-001</p>

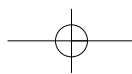

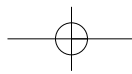
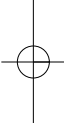
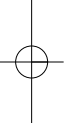
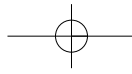

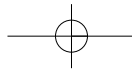

URETHROTOMIE
für 2,9 mm Ø Optik

URETHROTOMY
for 2,9 mm Ø optic

URETRÓTOMO
para óptica 2,9 mm Ø

URETROTOMO
per ottica 2,9 mm Ø



.....

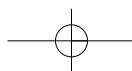

Urethrotomie
 Urethrotomy
 Uretrotomia
 Uretrotomia

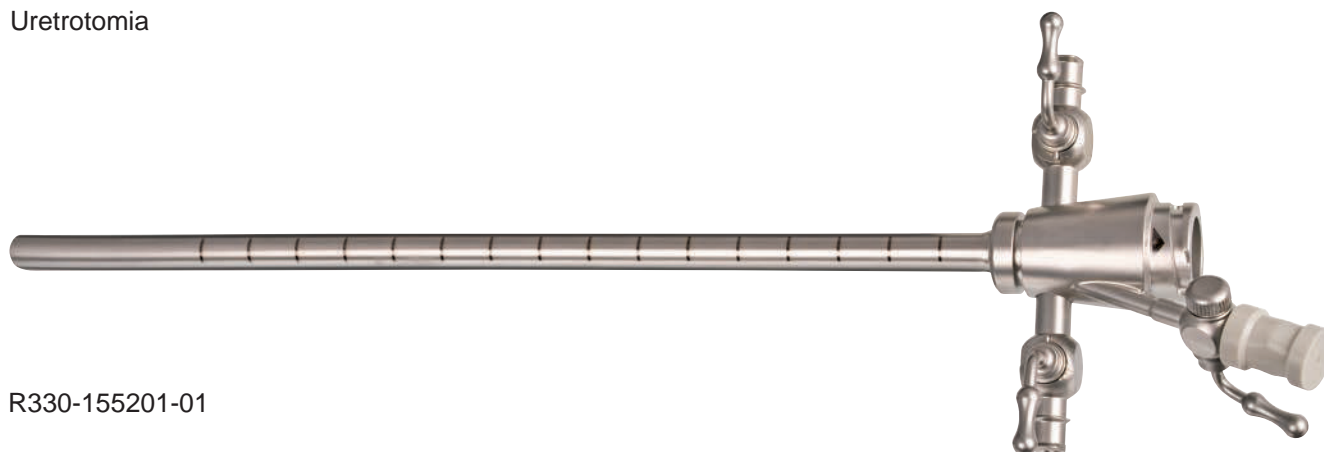

R330-155201-01

Urethrotomschaft 15,5 Char Ø graduiert seitlicher Kanal f. 3 Char Instrumente
 Urethrotome sheath 15,5 Char Ø, graduated lateral channel f. 3 Fr. Instruments
 Vaina para uretrotomo de 15,5 Char Ø con canal graduado lateral para instrumentos de 3. Char
 Camicia per uretrotomo 15,5 Char Ø con scale graduate dotato di canale operativo



R330-155201-102

Zusatzschaft für Urethrotomschaft 15,5 Char Ø, seitlich offen
 Supplementary sleeve for urethrotom-sleeve 15,5 Char Ø, lateral open
 Vaina adicional para uretrótomo de 15,5 Char Ø, apertura lateral
 Camicia supplementare per uretrotomo 15,5 Char Ø, aperta laterale

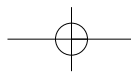
**HADEO**
INSTRUMENTE GERMANYUrethrotomie
Urethrotomy
Uretrotomia
Uretrotomia

R330-155000-11

Urethrotom Standard Obturator für 15,5 Char Ø Schaft R330-155201-01
Urethrotome standard obturator for 15,5 Char Ø sheath R330-155201-01
Obturador estándar para uretrótomo de 15,5 Char Ø vaina R330-155201-01
Otturatore per camicia per uretrotomo 15,5 Char Ø R330-155201-01

R339-029000-001

Optikbrücke mit 3 Char Ø Arbeitskanal
Telescope bridge w. 3 Char Ø working channel
Puente para optica con canal de trabajo de 3 Char Ø
Ponticello uretrotomo per strumenti 3 Char Ø

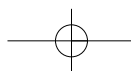
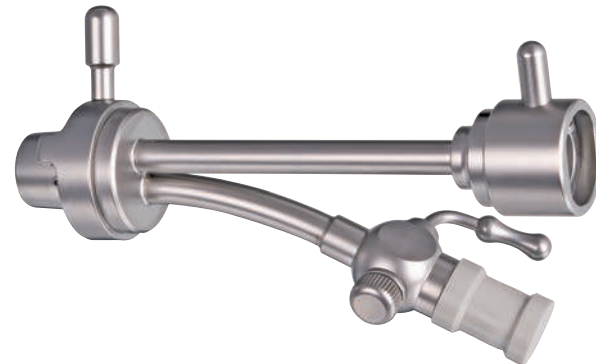

Strikturmesser
Cold knife
Cuchillo de corte frio
Lama uretrotomo per taglio a freddo



R339-155000-001
gerade
straight
recto
retto



R339-155000-002
Wellenschliff
wave shaped
filo ondulado
affilatura ondulata



R339-155000-011
rund
round shaped
semicircular
semisferico



R339-155000-031
sichelförmig
sickle shaped
en forma de hoz
ad uncino

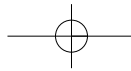

PÄDIATRISCHE UROLOGIE

Cystoskopie und Resektoskopie
9,5 & 11 Char Ø

PEDIATRIC UROLOGY

Cystoscopy and Resectoscopy
9,5 & 11 Fr. Ø

UROLOGÍA PEDIÁTRICA

Cistoscopia y Resectoscopia
9,5 & 11 Char Ø

UROLOGIA PEDIATRICA

Cistoscopia e Resettoscopia
9,5 & 11 Char Ø

HADEO
INSTRUMENTE GERMANY

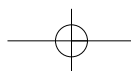

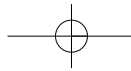

HADEO
INSTRUMENTE GERMANY

Optik
Optic
Óptica
Ottica



Blickrichtung
Angle of view
Dirección visual
Angolo di visione

Ø 2,0 mm

0° R300-020188-000

30° R300-020188-030

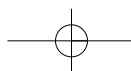

Cystoskop-Schäfte, Kinder
 Cystoscopy sheaths, Children
 Vainas para cistoscopio, pediatricos
 Camicie per cistoscopio, Pediatrico

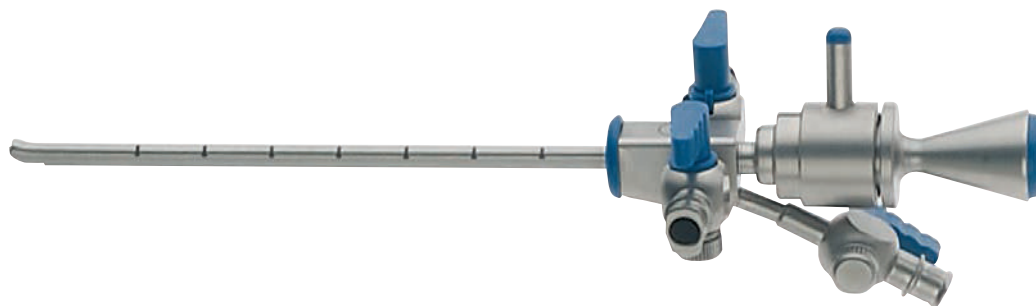

Ø [Char]

Cystoskop-Schaft, 2 Hähne fest mit LL-Adapter
 Cystoscopy sheath, 2 stop cocks fixed with LL-adapters
 Camisa para cistoscopio, 2 valvulas con adaptador de LL
 Camicia per cistoscopio, 2 rubinetti fissi con adattatore LL

9,5	Obturator	R310-095000-001
	Sheath	R310-095120-001
	Sheath + Obturator	R311-095120-001

11	Obturator	R310-110000-001
	Sheath	R310-110120-001
	Sheath + Obturator	R311-110120-001

Flexible Instrumente
 Flexible instruments
 Instrumentos flexible
 Instrumenti Flessibili

Imstrumente 30 cm lang
 Instruments 30 cm long
 Instrumentos de 30 cm largo
 Instrumenti lunghezza 30 cm

Ø 3 [Char]



Biopsiezange
 Biopsy forceps
 Pinza de biopsia
 Pinza per biopsia doppia articolazione

R392-010300-001



Alligatorfaßzange
 Alligator grasping forceps
 Pinza de agarre
 Pinza da presa tipo alligator doppia articolazione

R392-010300-011



Schere
 Scissor
 Tijera
 Forbici mono articolata

R392-010300-021



Löffel oval
 Spoon Forceps
 Cuchara oval
 Cucchiaino ovale con
 denti aggressivi

R392-010300-005

Resektoskop für Kinder
 Resectoscope for children
 Resectosopio para niños
 Resettore pediatrico

Arbeitselement
 Working element
 Vaina de trabajo
 Elemento di lavoro

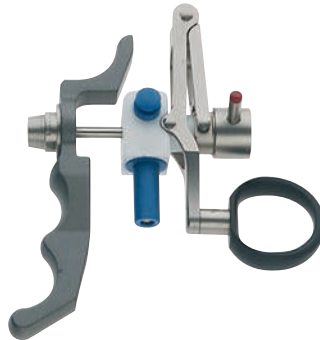

R320-027110-01
 (passiv/passive/pasivo/passivo)



R320-110110-030
 Resektoskop-Schaft Ø 11 Char
 Resectoscope sheat Ø 11 Char
 Vaina para resectoscopio de Ø 11 Char
 Camicia resettore Ø 11 Char

R320-110000-001
 Obturator Ø 11 Char
 Obturator Ø 11 Char
 Obturador Ø 11 Char
 Otturatore Ø 11 Char

Monopolare Elektroden
 Monopolar electrodes
 Electrodo monopolares
 Elettrodo Monopolare



Schlinge retrograde gebogen
 Loop, retrograde curved
 Asa, curva retrogradamente
 Ansa per taglio, angolata

Ø 11 [Char]
 R329-110000-001



Schlinge retrograde gebogen #2
 Loop, retrograde curved #2
 Asa, curva retrogradamente #2
 Ansa per taglio, angolata #2

R329-110000-002



Kugel
 Ball
 Bola
 Sferico

R329-110040-002
 (Ø 2 mm)



Messer
 Knife
 Cuchillo
 Elettrodo di coagulazione a bisturi

R329-110070-001

Urethrotomie Kleinkinder
 Urethrotomy infant
 Uretrotomia para niños
 Uretrotomia pediátrico

System für Ø 2,0 mm Optiken
 System for Ø 2,0 mm telescopes

R330-110086-01

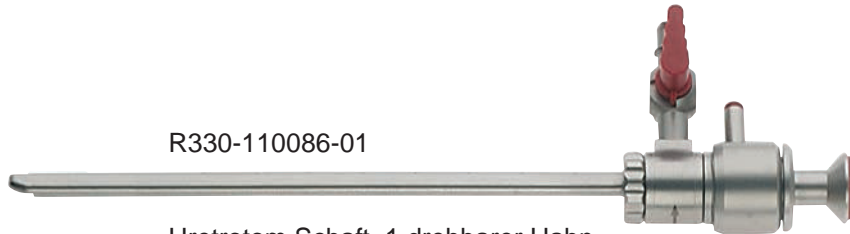

11 Fr.

Uretrotom Schaft, 1 drehbarer Hahn
 Urethrotome sheath, 1 turnable stopcock
 Vaina para uretrótomo, 1 llave rotable
 Camicia per uretrotomo, 1 rubinetto girevole

R330-110000-01

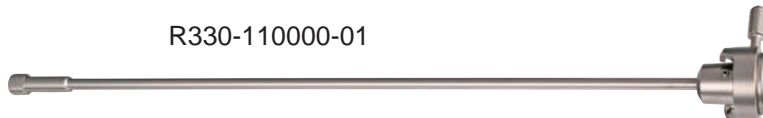

11 Fr.

Standard Obturator
 Obturator standard
 Obturador estándar
 Otturatore standard

R330-020110-01

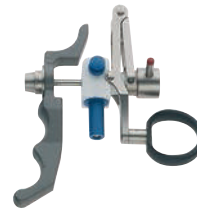

11 Fr.

Arbeitselement, passiv
 Working element, passive
 Vaina de trabajo, pasivo
 Elemento di lavoro, passivo

R339-110000-01

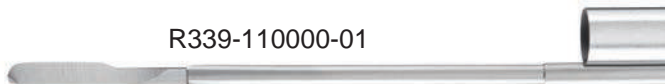

11 Fr.

gerade / straight / recto / retto

R339-110000-11

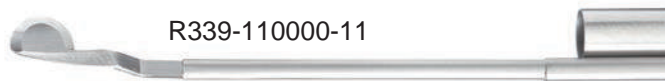

11 Fr.

rund / round shaped / semicircular / semisferico

R339-110000-41

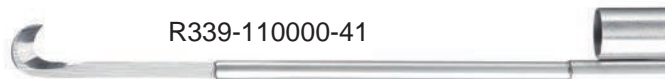

11 Fr.

sichelförmig / sickle shaped / en forma de hoz / ad uncino

R339-100000-31



11 Fr.

hakenförmig / hook shaped / en forma de gancho / ad uncino

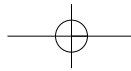

PÄDIATRISCHE UROLOGIE

Cystoskopie und Resektoskopie
13 Char Ø

PEDIATRIC UROLOGY

Cystoscopy and Resectoscopy
13 Fr. Ø

UROLOGÍA PEDIÁTRICA

Cistoscopia y Resectoscopia
13 Char Ø

UROLOGIA PEDIATRICA

Cistoscopia e Resettoscopia
13 Char Ø

HADEO
INSTRUMENTE GERMANY

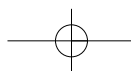

Optik
Optic
Óptica
Ottica



Blickrichtung
Angle of view
Dirección visual
Angolo di visione

Ø 2,7 mm / length 187 mm

0°	R300-027188-000
30°	R300-027188-030
70°	R300-027188-070

Cystoskop-Schäfte, Kinder
 Cystoscopy sheaths, Children
 Vainas para cistoscopio, pediatricos
 Camicie cistoscopio, Pediatrico



Ø [Char]

Cystoskop-Schaft, 2 Hähne fest mit LL-Adapter
 Cystoscopy sheath, 2 stop cocks fixed with LL-adapters
 Camisa para cistoscopio, 2 valvulas con adaptador de LL
 Camicia per cistoscopio, 2 rubinetti fissi con adattatore LL

13	Obturator	R310-130000-001
	Sheath	R310-130120-001
	Sheath + Obturator	R311-130120-001

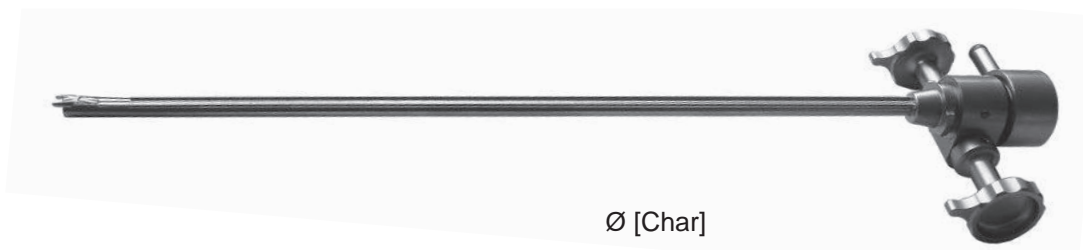

Ø [Char]

Albarran Lenkhebel
 Albarran deflector
 Palanca conductor tipo Albarran
 Leva di Albarran

13	R310-027000-011
----	-----------------



Ø [Char]

Optikbrücke
 Telescope bridge
 Puente para óptica
 Ponte diagnostico

13	R310-027000-000
----	-----------------

Flexible Instrumente
 Flexible instruments
 Instrumentos flexible
 Instrumenti Flessibili

Imstrumente 30 cm lang
 Instruments 30 cm long
 Instrumentos de 30 cm largo
 Instrumenti lunghezza 30 cm

Ø 3 [Char]



Biopsiezange
 Biopsy forceps
 Pinza de biopsia
 Pinza per biopsia doppia articolazione

R392-010300-001



Alligatorfaßzange
 Alligator grasping forceps
 Pinza de agarre
 Pinza da presa tipo alligator doppia articolazione

R392-010300-011



Schere
 Scissor
 Tijera
 Forbici mono articolata

R392-010300-021



Löffel oval
 Spoon Forceps
 Cuchara oval
 Cucchiaino ovale con
 denti aggressivi

R392-010300-005

Resektoskop für Kinder
Resectoscope for children
Resectoscopio para niños
Resettore pediatrico

Arbeitselement
Working element
Vaina de trabajo
Elemente di lavoro

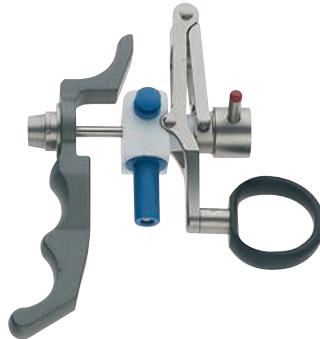

R320-027110-01
(passiv/passive/pasivo/passivo)



R320-130110-030
Resektoskop-Schaft Ø 13 Char
Resectoscope sheat Ø 13 Char
Vaina para resectoscopio de Ø 13 Char
Camicia resettore Ø 13 Char

R320-130000-001
Obturator Ø 13 Char
Obturator Ø 13 Char
Obturador Ø 13 Char
Otturatore Ø 13 Char

Monopolare Elektroden
Monopolar electrodes
Electrodos Monopolares
Monopolar elettrodo



Schlinge retrograde gebogen
Loop, retrograde curved
Asa, curva retrogradamente
Ansa per taglio, angolata

Ø 13 [Char]

R329-130000-001



Schlinge retrograde gebogen #2
Loop, retrograde curved #2
Asa, curva retrogradamente #2
Ansa per taglio, angolata #2

R329-130000-002



Kugel
Ball
Bola
Sferico

R329-130040-002
(Ø 2 mm)



Messer
Knife
Cuchillo
Elettrodo di coagulazione a bisturi

R329-130070-001

Urethrotomie Kinder
 Urethrotomy children
 Uretrotomia para niños
 Uretrotomia pediatrico

System für Ø 2,7 mm Optiken
 System for Ø 2,7 mm telescopes

R330-130086-01



13 Fr.

Uretrotom Schaft, 1 drehbarer Hahn
 Urethrotome sheath, 1 turnable stopcock
 Vaina para uretrótopo, 1 llave rotable
 Camicia per uretrotomo, 1 rubinetto girevole

R330-130000-01



13 Fr.

Standard Obturator
 Obturator standard
 Obturador estándar
 Otturatore standard

R320-027110-01

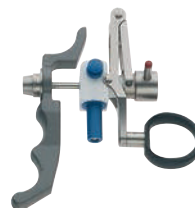

13 Fr.

Arbeitselement, passiv
 Working element, passive
 Vaina de trabajo, pasivo
 Elemento di lavoro, passivo

R339-130000-01

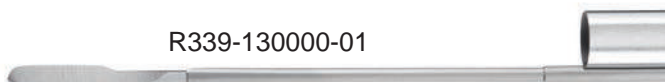

13 Fr.

gerade / straight / recto / retto

R339-130000-11

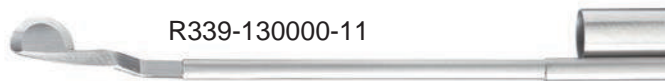

13 Fr.

rund / round shaped / semicircular / semisferico

R339-130000-41

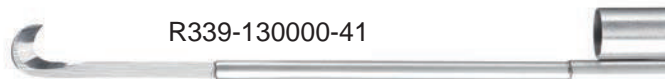

13 Fr.

sichelförmig / sickle shaped / en forma de hoz / ad uncino

R339-130000-31



13 Fr.

hakenförmig / hook shaped / en forma de gancho / ad uncino

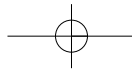

NEPHROSKOPIE

NEPHROSCOPY

NEFROSCOPIÁ

NEFROSCOPIA



Nephroskopie
 Nephroscopy
 Nefroscopía
 Nefroscopia

Nephroskop 7,45 mm Ø, 0° Blickrichtung, autoklavierbar
 Nephroscope 7,45 mm Ø, 0° angle of view, autoclaveable
 Nefroscopio de 7,45 mm Ø, 0° Dirección visual, autoclavable
 Nefroscopio 7,45 mm Ø, 0° Angolo di visione, autoclavabile

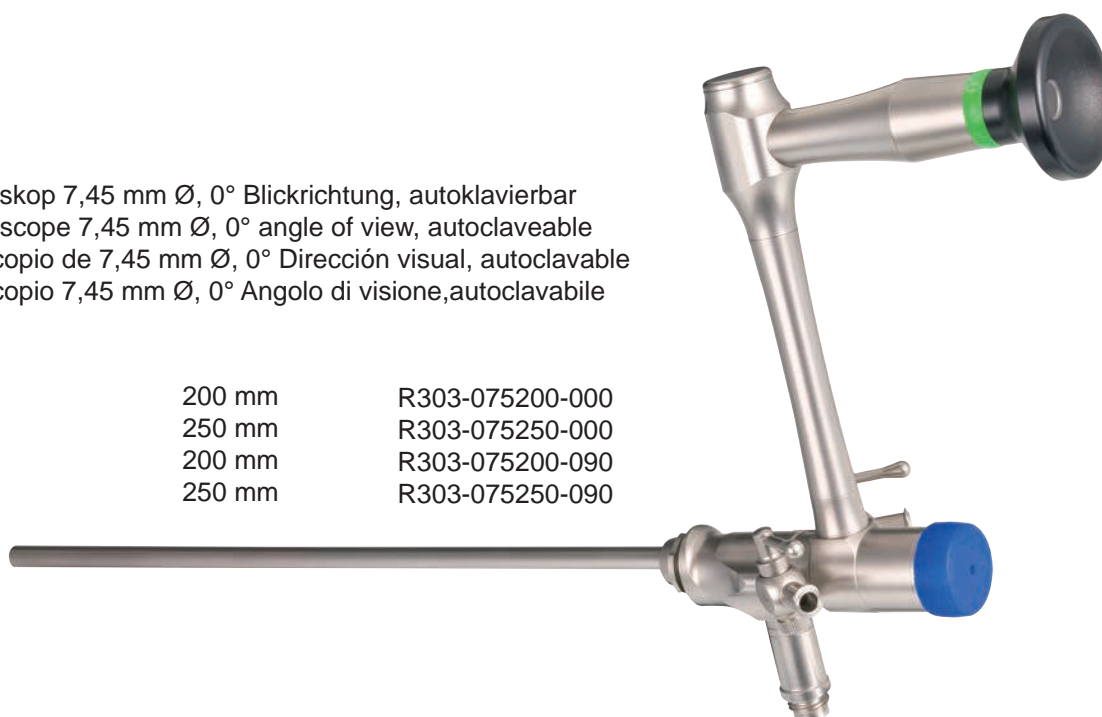

200 mm	R303-075200-000
250 mm	R303-075250-000
200 mm	R303-075200-090
250 mm	R303-075250-090

Nephroscope Operationsschaft, 1 Hahn drehbar
 Nephroscopy operating sheath, 1 stop cock rotatable
 Vaina para nefroscopio, 1 valvula rotable
 Camicia per nefroscopio, 1 rubinetto girevole

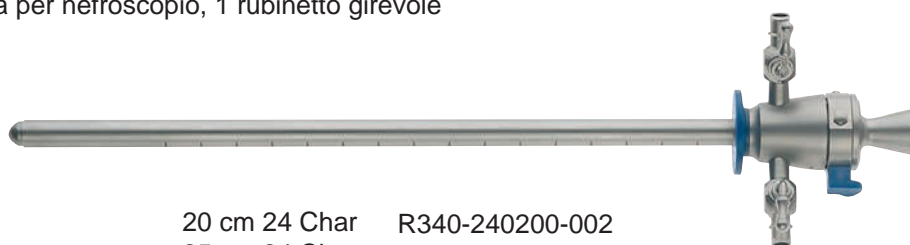

20 cm 24 Char	R340-240200-002
25 cm 24 Char	R340-240250-002
20 cm 26 Char	R340-260200-002
25 cm 26 Char	R340-260250-002

Obturator für Nephroskop-Schaft und Fascien Dilatator mit Kanal für Führungsdrähte
 Hollow Obturator and Fascial Dilator for Nephroscop sheath
 Obturador para vaina para nefroscopio y dilatador fascial con canal para guias
 Otturatore per camicia nefroscopio e dilatatore fasciale

20 cm 24 Char	R340-240200-001
25 cm 24 Char	R340-240250-001
20 cm 26 Char	R340-260200-001
25 cm 26 Char	R340-260250-001

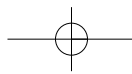

HADEO
INSTRUMENTE GERMANY

Teleskop Bougie
Telescope Bougie
Dilatadores telescopios
Dilatatore per telescopio



Ø [Char]

9	R350-090000-001
12	R350-120000-001
15	R350-150000-001
18	R350-180000-001
21	R350-210000-001
24	R350-240000-001
27	R350-270000-001
30	R350-300000-001

R350-000000-199

Set für Teleskop Bougies Ø 9 - 24 Char
Set for telescope bougies Ø 9 - 24 Char
Set para dilatadores telescopicos Ø 9 - 24 Char
Set per dilatatori telescopio Ø 9 - 24 Char

R350-000200-001 (ohne Abb.)

Führungssonde, flexibel
Guide wire, flexible
Guia, flexible
Sonda guida, flessibile

R350-000100-001 (ohne Abb.)

starr
rigid
rigido
rigido

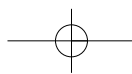

Instrumente Nephroskopie
 Instruments nephroscopy
 Instrumentos para Nefroscopia
 Instrumenti per Nefroscopia

	30 cm	40 cm
 <p>Biopsiezeuge Biopsy forceps Pinza de biopsia Pinza per biopsia con doppia articolazione</p>	R396-030300-001	R396-030400-001
 <p>Löffel oval Spoon Forceps Cuchara oval Cucchiaino ovale con denti aggressivi</p>	R396-030300-003	R396-030400-003
 <p>Alligatorfaßzange Alligator grasping forceps Pinza de agarre Pinza da presa tipo alligator con doppia articolazione</p>	R396-030300-011	R396-030400-011
 <p>Schere Scissor Tijera Forbici mono articolata</p>	R396-030300-021	R396-030400-021
 <p>Hakenschere Hook scissor Tijera en forma de gancho Forbici rette uncinatae mono articolate</p>	R396-030300-023	R396-030400-023

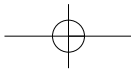

URETERO-RENOSKOPIE

URETERO-RENSCOPY

URETERO-RENOSCOPIÁ

URETERO-RENOSCOPIA









Uretero-Renoskope
 Uretero-Renoscopes
 Uretero-Renoscopio
 Uretero-Renoscopio

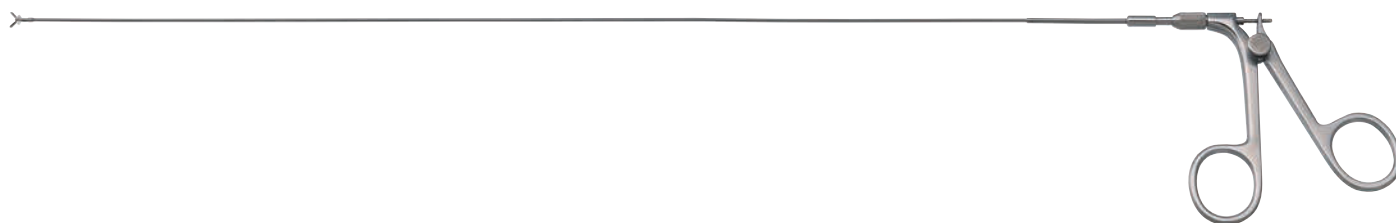





Ø [Char]	Ø Arbeitskanal [Char] Ø Working channel [Char] Ø Canal de trabajo [Char] Ø Canale di lavoro [Char]	Nutzlänge Working length Longitud util Lunghezza operativa	Blickrichtung 8° Angle of view 8° Dirección visual 8° Angolo di visione 8°
6 - 9	4	310 mm	R302-060310-008
6 - 9	4	425 mm	R302-060425-008
7,5 - 10	5	310 mm	R302-075310-008
7,5 - 10	5	425 mm	R302-075425-008

Flexible Instrumente 60 cm
 Flexible instruments 60 cm
 Instrumentos flexible 60 cm
 Instrumenti Flessibili 60 cm

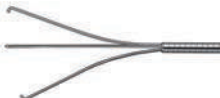

	Ø 3 [Char] Fr.	Ø 3,5 [Char] Fr.	Ø 4 [Char] Fr.	Ø 5 [Char] Fr.
 <p>Biopsiezange Biopsy forceps Pinza para biopsia Pinza per biopsia</p>	R392-010600-001	R392-012600-001	R392-014600-001	R392-017600-001
 <p>Löffelzange gezahnt Spoon forceps serrated Pinza de cuchara dentada Pinza per la rimozione</p>		R392-012600-008	R392-014600-008	R392-017600-008
 <p>Löffelzange lang gezahnt Spoon forceps long serrated Pinza de cuchara, larga dentada Pinza da presa</p>				R392-017600-006
 <p>Löffelzange kurz gezahnt Spoon forceps short serrated Pinza de cuchara, corta dentada Pinza da presa</p>		R392-012600-007		R392-017600-007
 <p>Faßzange gezahnt Grasping forceps serrated Pinza de agarre dentada Pinza da presa</p>		R392-012600-010		

Flexible Instrumente 60 cm
 Flexible instruments 60 cm
 Instrumentos flexible 60 cm
 Instrumenti Flessibili 60 cm

	Ø 3 [Char] Fr.	Ø 3,5 [Char] Fr.	Ø 4 [Char] Fr.	Ø 5 [Char] Fr.
 <p>Alligatorzange Alligator forceps serrated Pinza de agarre Pinza da presa tipo alligator</p>	R392-010600-011	R392-012600-011	R392-014600-011	R392-017600-011
 <p>Steinstrasse lang Grasping forceps Steinstrasse Pinza da calculos larga pinza de presa</p>		R392-012600-013		R392-017600-013
 <p>Fremdkörperzange Stein Foreign Body grasper stone Pinza para cuerpos extraños de calculos Pinza da presa per calculi</p>		R392-012600-014		R392-017600-014
 <p>3-Arm Greifer 3-prong grasper Pinza de agarre de 3 brazos Pinza tripode uncinata</p>	R392-010600-015			R392-017600-015
 <p>Rattenzahnfaßzange Rat tooth grasper Pinza de agarre con diente de raton Pinza da presa</p>	R392-010600-016		R392-014600-016	R392-017600-016
 <p>Fremdkörper Greifzange gefenstert Foreign body grasper fenestrated Pinza de agarre cuerpo extraño Pinza da presa per frammenti</p>		R392-012600-017		R392-017600-017
 <p>Ureter-Schlitzschere Uretero slitting scissors tijera para uréter forbici per incisione dell'uretere</p>		R392-012600-025		R392-017600-025

Dormia Steinfänger
 Dormia stone dislodger
 Malla para rescadar calculus
 Cestello dormia

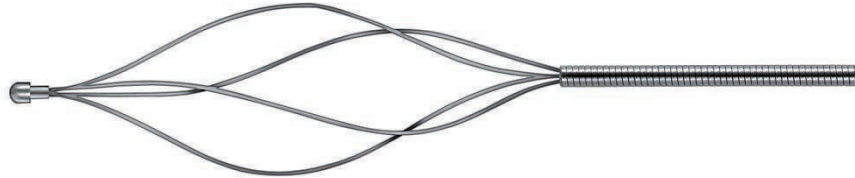

R394-010600-004

4 Drähte 3Char/1,0 mm Ø, 600 mm Nutzlänge
 4 wires 3Fr./1,0 mm Ø, 600 mm work.length,
 Malla de 4 alambre de 3 Char/1,0 mm para extraer calculos 600 mm de largo util
 Cestello dormia 4 filamenti, lunghezza 600 mm, Ø1,0 mm

R394-017600-004

4 Drähte 5Char/1,7 mm Ø, 600 mm Nutzlänge
 4 wires 5Fr./1,7 mm Ø, 600 mm work.length,
 Malla de 4 alambres de 5 Char/1,7 mm para extraer calculos 600 mm de largo util
 Cestello dormia 4 filamenti, lunghezza 600 mm, Ø1,7 mm

R394-017600-006

6 Drähte 5Char/1,7 mm Ø, 600 mm Nutzlänge
 6 wires 5Fr./1,7 mm Ø, 600 mm work.length,
 Malla de 6 alambres de 5 Char/1,7 mm para extraer calculos 600 mm de largo util
 Cestello dormia 6 filamenti, lunghezza 600 mm, Ø1,7 mm



R394-000000-000

Griff für Dormia Steinfänger
 handle for Dormia stone dislodger
 mango para Malla para rescadar calculus
 Impugnatura per Cestello dormia

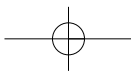
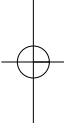
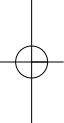
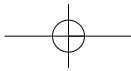

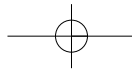

ZUBEHÖR

ACCESSORIES

ACCESORIOS

ACCESSORI



Zubehör Urologie
Accessories Urology
Accesorios para urologia
Accessori Urologia



67175-08

STOCKMANN Penisklemme
STOCKMANN penis seizing fcps.
STOCKMANN pinza p. el pene
STOCKMANN pinza serrapene



67177-11

STRAUSS Penisklemme
STRAUSS penis clamp
STRAUSS pinza p. el pene
STRAUSS pinza serrapene

Kathetereinführungsinstrumente, Dilatationsbougies
Catheter Introducer, Dilating Bougies
Introductor de catéteres, Bujías dilatadoras
Mandrini per sonde uretrali, Candelette dilatatrici

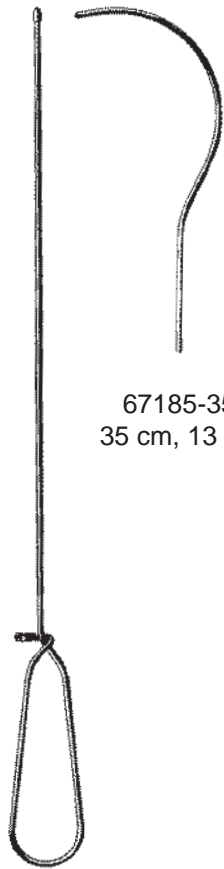

67185-35
35 cm, 13 3/4"

GUYON
67184-39
39 cm, 15 1/2"

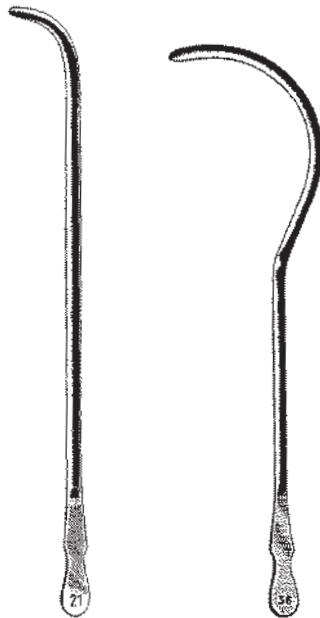

Charr. FG	28 cm (11") VAN BUREN	25 cm (10") GUYON	28 cm (11") DITTEL	30 cm (11 3/4") DITTEL
8	67201-08	67205-08	67206-08	67207-08
9			67206-09	67207-09
10	67201-10	67205-10	67206-10	67207-10
11			67206-11	67207-11
12	67201-12	67205-12	67206-12	67207-12
13			67206-13	67207-13
14	67201-14	67205-14	67206-14	67207-14
15			67206-15	67207-15
16	67201-16	67205-16	67206-16	67207-16
17			67206-17	67207-17
18	67201-18	67205-18	67206-18	67207-18
19			67206-19	67207-19
20	67201-20	67205-20	67206-20	67207-20
21			67206-21	67207-21
22	67201-22	67205-22	67206-22	67207-22
23			67206-23	67207-23
24	67201-24	67205-24	67206-24	67207-24
25			67206-25	67207-25
26	67201-26	67205-26	67206-26	67207-26
27			67206-27	67207-27
28	67201-28	67205-28	67206-28	67207-28
29			67206-29	67207-29
30	67201-30	67205-30	67206-30	67207-30
32	67201-32	67205-32		
34	67201-34	67205-34		
36	67201-36	67205-36		
38		67205-38		
40		67205-40		

OTIS Urethrotom für Erwachsene
 OTIS urethrotome for adults
 OTIS uretrótomo para adultos
 OTIS ureterotomo per adulti



Lieferumfang
 extent of delivery

67169-00

OTIS Dilatator
 OTIS dilatation
 OTIS instrumento de dilatación
 OTIS dilatatore



3 x Aufsätze (Kugel, Flach, Konisch)
 3 x tips (ball, flat, conical)
 juego de 3 x puntas (bola, plana, cónica)
 set di 3 x punte (a sfera, piatta e conica)



67169-01

2 x Messer
 2 x knives
 2 x cuchillos
 2 x bisturi

1 x Box



Blasenspritzen
 Bladder springs
 Jeringa para vejiga
 Siringa vescicale



Blasenspritze
 Bladder spring
 Jeringa para vejiga
 Siringa vescicale

Ersatzzylinder
 Spare barrels
 Cilindros de repuesto
 Cilindri di ricambio

50ml	R390-000050-001	R390-000050-999
75ml	R390-000075-001	R390-000075-999
100ml	R390-000100-001	R390-000100-999
150ml	R390-000150-001	R390-000150-999

Evakuator nach ELLIK
 Evacuador acc to ELLIK
 Evacuador segun ELLIK
 Evacuatore sec. ELLIK



R390-100000-000
 Komplet
 complete
 completo
 completo

R390-100000-100
 Gummiball
 Rubber ball
 Pera de goma
 Pompetta in gomma

R390-100000-200
 Glasbehälter
 Glass recipient
 Recipiente de vidrio
 Recipiente in vetro

R390-100000-300
 Schlauch mit Verriegelungs-Adapter
 Tube with locking device
 Tubo con adattador
 Tubo con adattatore

R390-100000-400
 Konus mit Schlauchteil
 Cone adapter with tube
 Cono con tubo
 Cono con segmento di Tubo

Zubehör Urologie
 Accesories Urology
 Accesorios para urologia
 Accessori Urologia

Luerlock-Schlauchverbinder
 luer-lock tubing connector
 luer-luck conector para el tubo
 luer-lock connettore per tubi



R070-000060-101
 männlich
 male
 macho
 maschio



R070-000060-201
 weiblich
 female
 femenino
 femminile

Luerlock-Schlauchverbinder mit Hahn
 luer-lock tubing connector with stopcock
 luer-lock conector para el tubo con llave
 luer-lock connettore per tubi; con rubinetto



R070-000060-001
 männlich
 male
 macho
 maschio

R070-000060-301
 weiblich
 female
 femenino
 femminile

Adapter für Blasenkatheter
 Adapter for bladder catheter
 Adaptador para Catéter
 Adattore per Catetero



R390-9001

Dichtkappe für Instrumentenkanal
 sealing cap for instrument channel
 capuchon de cierre para canal de instrumentos
 tappino in gomma; per canale strumenti



R210-000010-011
 1 mm

R210-000020-011
 2 mm

Nummernverzeichnis
 Numerical Index
 Índice numérico
 Indice numerico

HADEO
 INSTRUMENTE GERMANY

67169-00UR76	67206-21UR75	R300-040302-070UR 8
67169-01UR76	67206-22UR75	R302-060310-008UR68
67175-08UR74	67206-23UR75	R302-060425-008UR68
67177-11UR74	67206-24UR75	R302-075310-008UR68
67184-39UR75	67206-25UR75	R302-075425-008UR68
67185-35UR75	67206-26UR75	R303-075200-000UR64
67201-08UR75	67206-27UR75	R303-075200-090UR64
67201-10UR75	67206-28UR75	R303-075250-000UR64
67201-12UR75	67206-29UR75	R303-075250-090UR64
67201-14UR75	67206-30UR75	R310-027000-000UR59
67201-16UR75	67207-08UR75	R310-027000-011UR59
67201-18UR75	67207-09UR75	R310-029000-000UR36
67201-20UR75	67207-10UR75	R310-029000-001UR36
67201-22UR75	67207-11UR75	R310-029000-002UR36
67201-24UR75	67207-12UR75	R310-029000-011UR37
67201-26UR75	67207-13UR75	R310-029000-012UR37
67201-28UR75	67207-14UR75	R310-040000-000UR12
67201-30UR75	67207-15UR75	R310-040000-001UR12
67201-32UR75	67207-16UR75	R310-040000-002UR12
67201-34UR75	67207-17UR75	R310-040000-011UR13
67201-36UR75	67207-18UR75	R310-040000-012UR13
67205-08UR75	67207-19UR75	R310-040000-021UR13
67205-10UR75	67207-20UR75	R310-040000-022UR13
67205-12UR75	67207-21UR75	R310-095000-001UR53
67205-14UR75	67207-22UR75	R310-095120-001UR53
67205-16UR75	67207-23UR75	R310-110000-001UR53
67205-18UR75	67207-24UR75	R310-110120-001UR53
67205-20UR75	67207-25UR75	R310-130000-001UR59
67205-22UR75	67207-26UR75	R310-130120-001UR59
67205-24UR75	67207-27UR75	R310-150000-001UR35
67205-26UR75	67207-28UR75	R310-150235-001UR35
67205-28UR75	67207-29UR75	R310-170000-001UR10
67205-30UR75	67207-30UR75	R310-170000-003UR10
67205-32UR75	R070-000060-001UR78	R310-170235-001UR10
67205-34UR75	R070-000060-101UR78	R310-190000-001UR10
67205-36UR75	R070-000060-201UR78	R310-190000-003UR10
67205-38UR75	R070-000060-301UR78	R310-190235-001UR10
67205-40UR75	R210-000010-011UR78	R310-210000-001UR10
67206-08UR75	R210-000020-011UR78	R310-210000-003UR10
67206-09UR75	R300-020188-000UR52	R310-210235-001UR10
67206-10UR75	R300-020188-030UR52	R310-230000-001UR10
67206-11UR75	R300-027188-000UR58	R310-230000-003UR10
67206-12UR75	R300-027188-030UR58	R310-230235-001UR10
67206-13UR75	R300-027188-070UR58	R310-240000-001UR20
67206-14UR75	R300-029302-000UR34	R310-250000-001UR10
67206-15UR75	R300-029302-015UR34	R310-250000-003UR10
67206-16UR75	R300-029302-030UR34	R310-250235-001UR10
67206-17UR75	R300-029302-070UR34	R311-095120-001UR53
67206-18UR75	R300-040302-000UR 8	R311-110120-001UR53
67206-19UR75	R300-040302-015UR 8	R311-130120-001UR59
67206-20UR75	R300-040302-030UR 8	R311-150235-001UR35

R311-170235-001UR10	R320-220190-130UR43	R329-240054-003UR28
R311-190235-001UR10	R320-240000-001UR26	R329-240054-005UR28
R311-210235-001UR10	R320-240000-002UR26	R329-240055-001UR27
R311-230235-001UR10	R320-240000-003UR26	R329-240056-001UR27
R311-250235-001UR10	R320-240000-005UR26	R329-240070-001UR28
R312-040000-01UR20	R320-240000-030UR24	R329-240090-003UR28
R312-150000-001UR11	R320-240000-130UR24	R329-270000-001UR27
R312-150235-001UR11	R320-260000-030UR24	R329-270010-001UR27
R312-170235-001UR11	R320-260000-130UR24	R329-270030-001UR27
R312-190235-001UR11	R320-260240-030UR25	R329-270040-003UR27
R312-210235-001UR11	R320-260240-130UR25	R329-270040-005UR27
R312-230235-001UR11	R320-270000-001UR26	R329-270050-003UR27
R312-250235-001UR11	R320-270000-002UR26	R329-270050-005UR27
R313-150235-001UR11	R320-270000-003UR26	R329-270055-001UR27
R313-170235-001UR11	R320-270000-005UR26	R329-990UR28
R313-190235-001UR11	R320-270000-030UR24	R330-110000-01UR56
R313-210235-001UR11	R320-270000-130UR24	R330-110086-01UR56
R313-230235-001UR11	R320-285000-030UR24	R330-130000-01UR62
R313-240235-001UR20	R320-285000-130UR24	R330-130086-01UR62
R313-250235-001UR11	R320-285270-030UR25	R330-155000-11UR49
R315-021000-01UR14	R320-285270-130UR25	R330-155201-01UR48
R315-021000-011UR14	R329-040000-003UR23	R330-155201-102UR48
R315-021000-021UR14	R329-040000-005UR23	R330-210000-01UR31
R315-021000-06UR14	R329-040000-203UR23	R330-210000-11UR31
R315-021000-30UR15	R329-040000-205UR23	R330-210201-01UR30
R315-021000-70UR15	R329-050000-003UR23	R330-230201-001UR30
R315-240000-59UR20	R329-050000-005UR23	R330-230201-102UR30
R315-250000-39UR20	R329-080000-003UR23	R339-029000-001UR49
R315-901UR15	R329-080000-005UR23	R339-040000-001UR31
R315-902UR15	R329-110000-001UR55	R339-110000-001UR56
R319-900-01UR13	R329-110000-002UR55	R339-110000-011UR56
R320-027110-01UR55	R329-110040-002UR55	R339-110000-031UR56
R320-027225-01UR40	R329-110070-001UR55	R339-110000-041UR56
R320-027225-02UR40	R329-130000-001UR61	R339-130000-001UR62
R320-027225-11UR40	R329-130000-002UR61	R339-130000-011UR62
R320-027225-12UR40	R329-130040-002UR61	R339-130000-031UR62
R320-040225-01UR22	R329-130070-001UR61	R339-130000-041UR62
R320-040225-02UR22	R329-190000-001UR45	R339-155000-001UR50
R320-040225-11UR22	R329-190030-001UR45	R339-155000-002UR50
R320-040225-12UR22	R329-190040-002UR45	R339-155000-011UR50
R320-110000-001UR55	R329-190050-003UR45	R339-155000-031UR50
R320-110110-030UR55	R329-190070-001UR45	R339-210000-001UR32
R320-130000-001UR61	R329-240000-001UR27	R339-210000-002UR32
R320-130110-030UR61	R329-240010-001UR27	R339-210000-011UR32
R320-190000-001UR44	R329-240030-001UR27	R339-210000-021UR32
R320-190000-003UR44	R329-240040-003UR27	R339-210000-031UR32
R320-190000-030UR42	R329-240040-005UR27	R340-240200-001UR64
R320-190000-130UR42	R329-240050-003UR27	R340-240200-002UR64
R320-220000-030UR42	R329-240050-005UR27	R340-240250-001UR64
R320-220000-130UR42	R329-240052-003UR28	R340-240250-002UR64
R320-220190-030UR43	R329-240052-005UR28	R340-260200-001UR64

Nummernverzeichnis
Numerical Index
Indice numérico
Indice numerico

HADEO
INSTRUMENTE GERMANY

R340-260200-002UR64	R392-012600-013UR70	R394-017600-004UR18
R340-260250-001UR64	R392-012600-014UR70	R394-017600-006UR18
R340-260250-002UR64	R392-012600-017UR70	R395-000000-000UR19
R350-000000-199UR65	R392-012600-025UR70	R395-010450-001UR19
R350-000100-001UR65	R392-012800-025UR70	R395-010450-021UR19
R350-000200-001UR65	R392-014400-001UR38	R395-017400-125UR19
R350-090000-001UR65	R392-014400-011UR38	R395-017450-001UR19
R350-120000-001UR65	R392-014400-021UR38	R395-017450-011UR19
R350-150000-001UR65	R392-014600-001UR69	R395-017450-021UR19
R350-180000-001UR65	R392-014600-008UR69	R395-023400-125UR19
R350-210000-001UR65	R392-014600-011UR70	R395-023450-001UR19
R350-240000-001UR65	R392-014600-016UR70	R395-023450-011UR19
R350-270000-001UR65	R392-017400-001UR16	R395-023450-021UR19
R350-300000-001UR65	R392-017400-003UR16	R395-030450-001UR19
R390-000050-001UR77	R392-017400-005UR16	R395-030450-011UR19
R390-000050-999UR77	R392-017400-011UR17	R396-030300-001UR66
R390-000075-001UR77	R392-017400-021UR17	R396-030300-003UR66
R390-000075-999UR77	R392-017600-001UR69	R396-030300-011UR66
R390-000100-001UR77	R392-017600-006UR69	R396-030300-021UR66
R390-000100-999UR77	R392-017600-007UR69	R396-030300-023UR66
R390-000150-001UR77	R392-017600-008UR69	R396-030400-001UR66
R390-000150-999UR77	R392-017600-011UR70	R396-030400-003UR66
R390-000200-001UR77	R392-017600-013UR70	R396-030400-011UR66
R390-000200-999UR77	R392-017600-014UR70	R396-030400-021UR66
R390-100000-000UR77	R392-017600-015UR70	R396-030400-023UR66
R390-100000-001UR77	R392-017600-016UR70		
R390-100000-100UR77	R392-017600-017UR70		
R390-100000-200UR77	R392-017600-025UR70		
R390-100000-300UR77	R392-021400-001UR16		
R390-100000-400UR77	R392-021400-003UR16		
R390-9001UR78	R392-021400-005UR16		
R392-010300-001UR54	R392-021400-006UR16		
R392-010300-005UR54	R392-021400-011UR17		
R392-010300-011UR54	R392-021400-021UR17		
R392-010300-021UR54	R392-023400-001UR16		
R392-010400-001UR38	R392-023400-003UR16		
R392-010400-005UR38	R392-023400-004UR16		
R392-010400-011UR38	R392-023400-005UR16		
R392-010400-021UR38	R392-023400-009UR16		
R392-010600-001UR69	R392-023400-011UR17		
R392-010600-011UR70	R392-023400-014UR17		
R392-010600-015UR70	R392-023400-021UR17		
R392-010600-016UR70	R392-023400-022UR17		
R392-012400-001UR38	R392-023400-023UR17		
R392-012400-011UR38	R392-030400-001UR16		
R392-012400-021UR38	R392-030400-003UR16		
R392-012600-001UR69	R392-030400-011UR17		
R392-012600-007UR69	R392-030400-021UR17		
R392-012600-008UR69	R392-030400-023UR17		
R392-012600-010UR69	R394-000000-000UR18		
R392-012600-011UR70	R394-010600-004UR71		

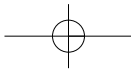

HADEO
INSTRUMENTE GERMANY

